



ALL RIGHTS RESERVED. NO PORTION OF THIS PUBLICATION, WHETHER IN WHOLE OR IN PART CAN BE REPRODUCED WITHOUT THE EXPRESS WRITTEN CONSENT OF SPC TECHNOLOGY.

SPC-F005.DWG

REVISIONS

DOC. NO. SPC-F005 • Effective: 7/8/02 • DCP No: 1398

DCP #	REV	DESCRIPTION	DRAWN	DATE	CHECKD	DATE	APPRVD	DATE
1876	A	RELEASED	EO	05/23/06	TL	06/07/06	HO	06/07/06

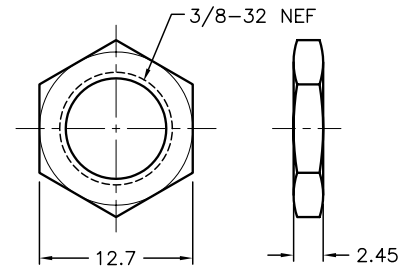
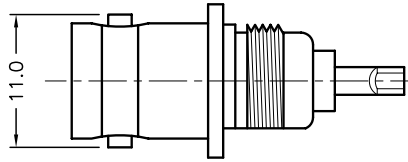

**NUT**

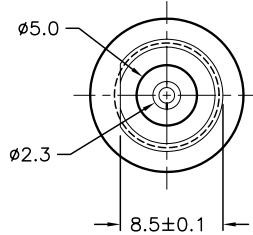
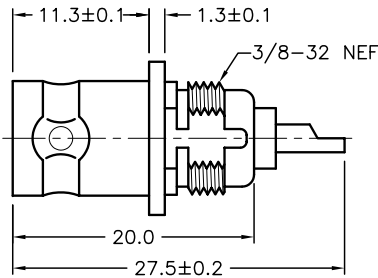
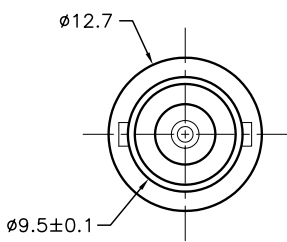

**BODY**

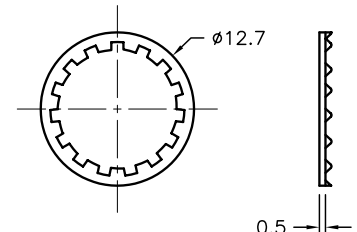

**LOCK WASHER**

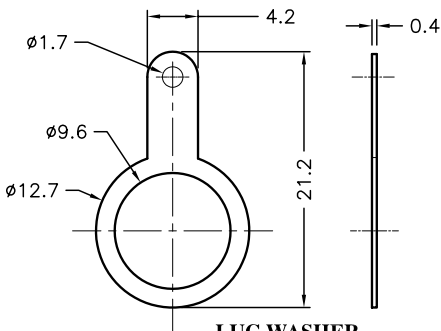

**LUG WASHER**

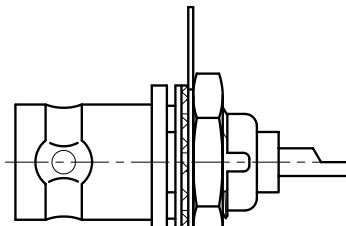

**ASSEMBLY**

**Specification:**

1. Body: Brass, Nickel-Plated
2. Center Contact: Brass, Nickel-Plated
3. Insulator: Delrin
4. Nut: Brass, Nickel-Plated
5. Lug Washer: Steel, Nickel-Plated
6. Lock Washer: Steel, Nickel-Plated

DISCLAIMER:  
ALL STATEMENTS AND TECHNICAL INFORMATION CONTAINED HEREIN ARE BASED UPON INFORMATION AND/OR TESTS WE BELIEVE TO BE ACCURATE AND RELIABLE. SINCE CONDITIONS OF USE ARE BEYOND OUR CONTROL, THE USER SHALL DETERMINE THE SUITABILITY OF THE PRODUCT FOR THE INTENDED USE AND ASSUME ALL RISK AND LIABILITY WHATSOEVER IN CONNECTION THEREWITH.

TOLERANCES:  
Unless Otherwise Specified  
.X ±0.2 [0.008]  
.XX ±0.12 [0.005]

DRAWN BY:	DATE:
EKLAS ODISH	05/23/06
CHECKED BY:	DATE:
THOMAS LEE	06/07/06
APPROVED BY:	DATE:
HISHAM ODISH	06/07/06

DRAWING TITLE:			
BNC BULKHEAD JACK, RoHS COMPLIANT			
SIZE	DWG. NO.	ELECTRONIC FILE	REV
A	SPC15415	79K4997.DWG	A
SCALE:	NTS	U.O.M.: mm [INCHES]	SHEET: 1 OF 1