



Buccaneer®

A full range of IP68 rated environmentally sealed circular connectors designed to provide secure and safe connections in harsh or hostile conditions. The range consists of the miniature 400 Series, Mini, Standard and the heavy duty, high current 900 Series. With a wide choice of alternatives from 2 to 25 poles, BNC connections and screw, solder or crimp terminations, the Buccaneer series provide the answer to many design problems.

Screw terminations ensure simple 'field' connection, whilst crimp terminations fulfil the requirement for fast and effective volume connections. Each range has flex cable connector, in-line flex cable connectors and panel mounting connector options.

The Buccaneer® series find numerous applications either in external environments or where protection against the ingress of moisture is needed.



Type		Page
900 Series Buccaneer		
PX0911 - PX0921	Cable Mounting	15
PXA911 - PXA921	Cable Mounting - Large dia. cable	15
PX0931 - PX0941	Panel Mounting	16
PX0950 - PX0980	Bulkhead & Accessories	17
Standard Buccaneer		
PX0727 - PX0769	2 - 9 pole	20-21
PX0820 - PX0824	25 pole	20-21
PX0733 - PX0734	Accessories	22
PX0777	In-line Cable Joiner	24
Mini Buccaneer		
PX0800 - PX0805	Body Styles	26
PX0810 - PX0811	Accessories	27
400 Series Buccaneer		
PX0410 - PX0411	Cable Mounting	30
PX0412	Panel Mounting	30
SA3179-SA3350	Contacts	31
Specification		32

Other sealed products included:

- Panel Mounting Fuseholders
- In-Line Fuseholders
- LEDs
- Switches
- Switch Seals
- Sealed Screws

900 Series Buccaneer®

Buccaneer®
Connectors



IP68

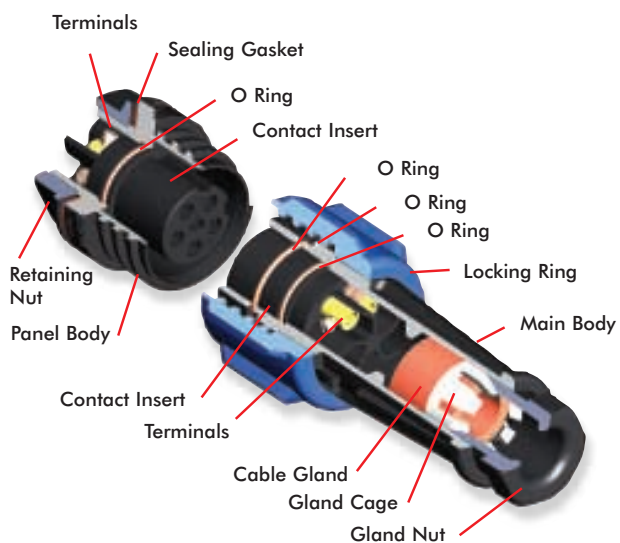

- 32A, 600V ac/dc rating
- 2, 3, 4, 5 and 7 pole
- Plug or socket connection in each body style
- Water and dustproof to IP68 when mated
- IP68 rating tested at 15lb/sq in (10m depth) for 2 weeks
- 'Scoop proof' contacts
- Field termination - screw terminations
- Positive locating keyways - cannot be misconnected
- Sealing caps available to maintain IP68 rating of unmated connectors
- Leading earth contact for 3, 4, 5 and 7 pole versions
- UL, CSA and VDE approvals
- Trailing Neutral on 5 pole
- Compact design
- Easy assembly - no special tools required
- Single or 3 phase applications
- Bulkhead moulding available for use with flange mounting body for 45° or 90° mounting (order each separately)
- Cost effective solution
- Two cable connector versions for 15mm and 22mm cable diameters
- Separate strain relief on large cable version

900 Series Buccaneer®



- Flex cable connector
- Positive, fast acting locking ring - can be turned with a gloved hand
- Mates with in-line flex or panel mounting versions
- Plug or socket versions
- PX0 Series 13-15mm cable dia. as standard, 7-13mm with additional gland pack
- PXA Series 20-22mm cable dia. as standard, 14-20mm with additional gland pack
- Strain Relief Clamp (PXA Series only)

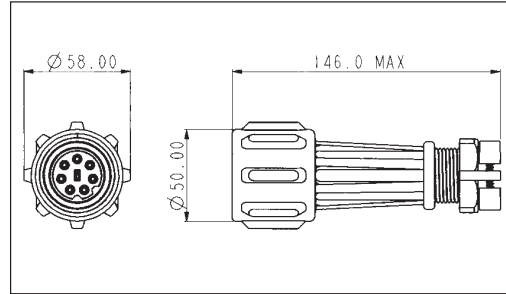
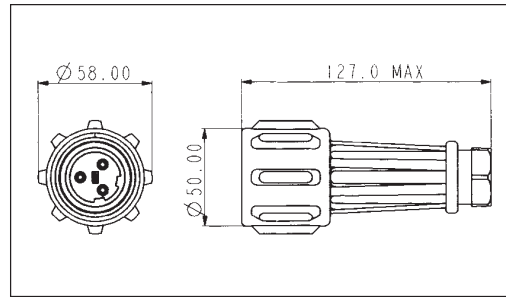

Buccaneer® Connectors

Flex Cable

Standard Cable	Large Cable	Description	Standard Cable	Large Cable	Description
PX0911/02/P	PXA911/02/P	2 pole Plug	PX0911/02/S	PXA911/02/S	2 pole Socket
PX0911/03/P	PXA911/03/P	3 pole Plug	PX0911/03/S	PXA911/03/S	3 pole Socket
PX0911/04/P	PXA911/04/P	4 pole Plug	PX0911/04/S	PXA911/04/S	4 pole Socket
PX0911/05/P	PXA911/05/P	5 pole Plug	PX0911/05/S	PXA911/05/S	5 pole Socket
PX0911/07/P	PXA911/07/P	7 pole Plug	PX0911/07/S	PXA911/07/S	7 pole Socket



- In-line flex cable connector
- Mates with either PX0911/xx/x or PXA911/xx/x connectors
- Plug or socket versions
- PX0 Series 13-15mm cable dia. as standard, 7-13mm with additional gland pack
- PXA Series 20-22mm cable dia. as standard, 14-20mm with additional gland pack
- Strain Relief Clamp (PXA Series only)

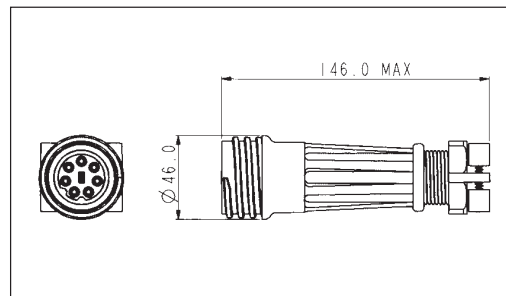
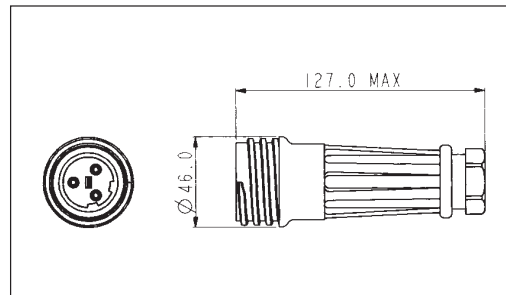

In-Line Flex Cable

Standard Cable	Large Cable	Description	Standard Cable	Large Cable	Description
PX0921/02/P	PXA921/02/P	2 pole Plug	PX0921/02/S	PXA921/02/S	2 pole Socket
PX0921/03/P	PXA921/03/P	3 pole Plug	PX0921/03/S	PXA921/03/S	3 pole Socket
PX0921/04/P	PXA921/04/P	4 pole Plug	PX0921/04/S	PXA921/04/S	4 pole Socket
PX0921/05/P	PXA921/05/P	5 pole Plug	PX0921/05/S	PXA921/05/S	5 pole Socket
PX0921/07/P	PXA921/07/P	7 pole Plug	PX0921/07/S	PXA921/07/S	7 pole Socket

BULGIN Buccaneer® Connectors

900 Series Buccaneer®

Buccaneer® Connectors



- Panel mounting connector
- Single hole fixing
- Anti-rotation key
- High grade sealing gasket
- 3-7mm panel thickness
- Mates with PX0911/xx/x and PXA911/xx/x connectors

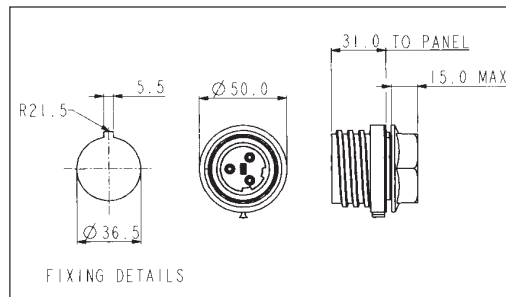

Panel Mounting

PX0931/02/P	2 pole Plug	PX0931/02/S	2 pole Socket
PX0931/03/P	3 pole Plug	PX0931/03/S	3 pole Socket
PX0931/04/P	4 pole Plug	PX0931/04/S	4 pole Socket
PX0931/05/P	5 pole Plug	PX0931/05/S	5 pole Socket
PX0931/07/P	7 pole Plug	PX0931/07/S	7 pole Socket



- Flange mounting connector
- Supplied with high grade sealing gasket
- Supplied with sealing grommets for panel fixing screws (M6 thread recommended)
- Mates with PX0911/xx/x and PXA911/xx/x connectors

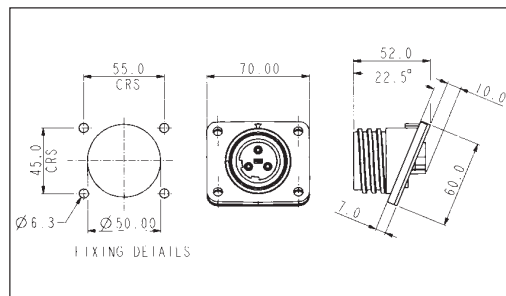

Flange Mounting

PX0941/02/P	2 pole Plug	PX0941/02/S	2 pole Socket
PX0941/03/P	3 pole Plug	PX0941/03/S	3 pole Socket
PX0941/04/P	4 pole Plug	PX0941/04/S	4 pole Socket
PX0941/05/P	5 pole Plug	PX0941/05/S	5 pole Socket
PX0941/07/P	7 pole Plug	PX0941/07/S	7 pole Socket

900 Series Buccaneer®

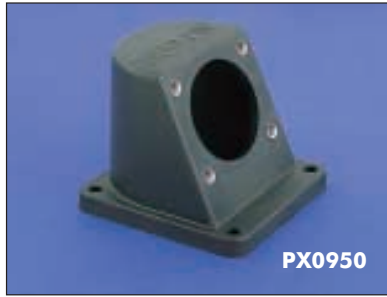

- Additional bulkhead adaptor moulding
- For use with flange mounting connector PX0941, to give 45° or 90° angle
- Supplied with high grade sealing gasket
- Supplied with sealing grommets for panel fixing screws (M6 thread recommended)

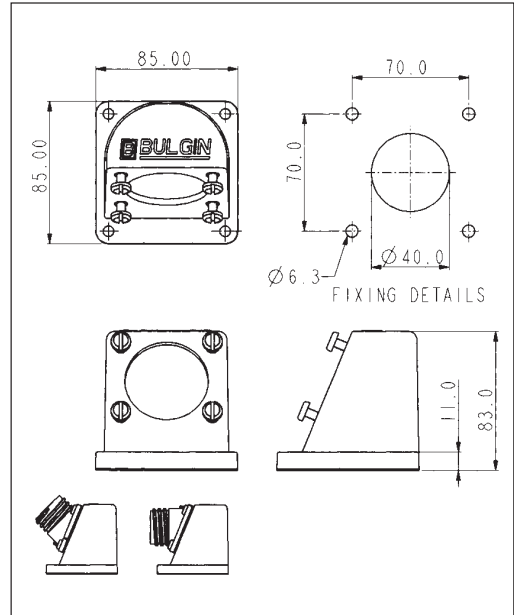

Buccaneer® Connectors



- Sealing caps to maintain IP68 rating of unmated connectors

Accessories

PX0960	Sealing cap for use with PX0911/xx/x and PXA911/xx/x
PX0970	Sealing cap for use with all other styles
PX0980	Pack of 3 additional cable glands for PX0911 and PX0921 to suit cable sizes; 11-13mm, 9-11 and 7-9mm dia.
PXA980	Pack of 3 additional cable glands for PXA911 and PXA921 to suit cable sizes; 18-20mm, 16-18 and 14-16mm dia.

Part No System

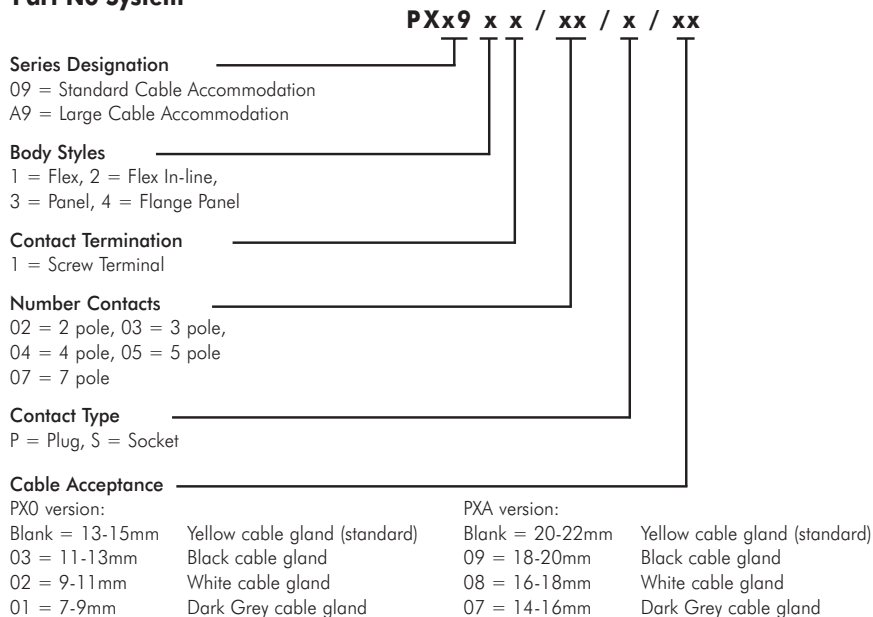

BULGIN Buccaneer® Connectors

900 Series Buccaneer®

Specification

Electrical:

No Poles:	2,3	4,5	7*
Current Rating:	32A 30A, CSA	32A 25A, CSA	32A
Voltage Rating:	600V ac/dc	600V ac/dc	430V ac/dc
Contact Resistance:	<10mΩ (initial)		
Insulation Resistance:	>10 ⁶ MΩ (@ 500V dc)		
Dielectric strength:	2.2kV ac min		
AC Breakdown voltage:	6kV a.c. min.		
Operating Temperature Range:	-40°C to +85°C		
Approvals:			

* approvals pending

Material:

Body Mouldings:	Polyamide
Flammability Rating:	UL94V-0
UV Resistance:	To EN50021: 1999
Contacts:	Machined Solid Brass, Nickel plated
O Rings:	Nitrile
Panel Sealing Gasket:	Silicone Rubber

Mechanical:

Sealing:	IP68, EN60529IP68 tested @ 15lb/sq.in. (10m depth) for 2 weeks
Cable Acceptance:	PX0911-PX0921 13 - 15mm O/D standard, 7-13mm with gland pack PXA911-PXA921 20 - 22mm O/D standard, 14 - 20mm with gland pack
Contact Accommodation:	2.5 (13AWG) to 4mm ² (10AWG) conductor, single or multi stranded
Termination:	Axial screw terminals
Cable Retention force:	15mm dia, 150N 7mm dia, 80N
Tightening Torques:	
Panel mount nut	2.25 Nm
Cable gland nut	1.69 Nm
Flange & Bulkhead fixing screws	0.9 Nm

Dimensions:

Overall dimensions of connectors when mated together

PX0911 + PX0921	230 mm max.
PXA911 + PXA921	270 mm max.
PX0911 + PX0931	135 mm max. (to panel)
PXA911 + PX0931	175 mm max. (to panel)
PX0911 + PX0941	145 mm max. (to panel, mid point on flange)
PXA911 + PX0941	174 mm max. (to panel, mid point on flange)

IP68

Standard Buccaneer®

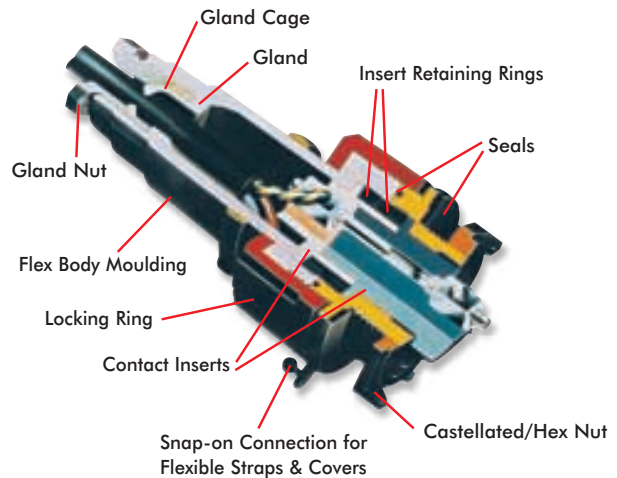

Buccaneer®
Connectors

- Diameter over coupling ring 38mm
- 2, 3, 4, 6, 7, 9 and 25 pole
- 10A, 250V a.c. 2 & 3 pole screw terminal
- 6A, 250V a.c. 4 pole screw terminal
- 3A, 250V a.c. 6 and 7 pole screw terminal
- 5A, 150V a.c. 9 pole crimp contacts
- 1A, 50V a.c. 25 pole crimp or solder contacts
- Plug or socket connection in each body style
- Positive locating keyways - cannot be mis-connected
- Compact design
- UL, CSA and VDE approvals
- Water and dustproof to IP68 when mated
- IP68 rating tested at 15lb/sq in (10m depth) for 2 weeks and 140lb/sq in (100m depth) for 12 hours
- Sealing caps available to maintain IP68 rating of unmated connectors
- 5 body styles - flex & in-line flex, panel - single hole & flange mounting
- Leading earth contact for 3 pole socket version
- Easy assembly - no special tools required on screw terminal versions
- Cable range from 3.5mm - 9mm

BULGIN Buccaneer® Connectors

Standard Buccaneer®

Buccaneer®
Connectors



Flex Mounting

- Flex Cable Connector
- Screw Locking Ring
- Pin or Socket Versions
- Leading Earth on 3 pole connectors
- Poles 2, 3, 4, 6, 7, 9, 25 or BNC
- Standard Cable Acceptance 6-8mm, 3.5-9 mm with alternative glands
- Mates with In-Line Flex or Panel Mounting Versions

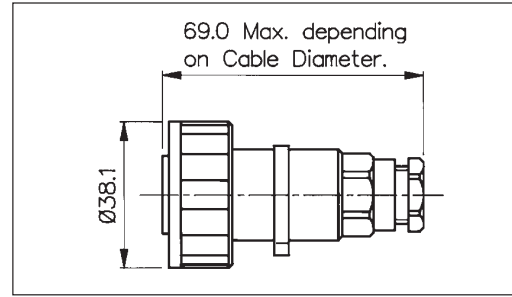

Poles	Termination	Pin Contacts	Socket Contacts	Contacts
2	Screw	PX0736/P	PX0736/S	Supplied Fitted
3	Screw	PX0731/P	PX0731/S	Supplied Fitted
4	Screw	PX0748/P	PX0748/S	Supplied Fitted
6	Screw	PX0739/P	PX0739/S	Supplied Fitted
7	Screw	PX0745/P	PX0745/S	Supplied Fitted
9	Crimp	PX0728/P	PX0728/S	Supplied Loose
25	Crimp/Solder	PX0820/P	PX0820/S	Order Separately
50ΩBNC	Crimp	PX0742/P/50Ω		Supplied Loose
75ΩBNC	Crimp	PX0742/P/75Ω		Supplied Loose



In-Line Flex Mounting Connector

- In-Line Flex Cable Connector
- Pin or Socket Versions
- Leading Earth on 3 pole connectors
- Poles 2, 3, 4, 6, 7, 9, 25 or BNC
- Standard Cable Acceptance 6-8mm, 3.5-9 mm with alternative glands
- Mates with Flex Cable Connector

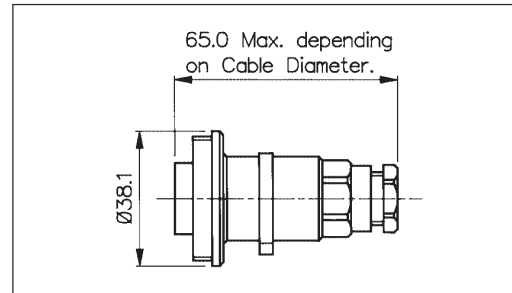

Poles	Termination	Pin Contacts	Socket Contacts	Contacts
2	Screw	PX0737/P	PX0737/S	Supplied Fitted
3	Screw	PX0732/P	PX0732/S	Supplied Fitted
4	Screw	PX0749/P	PX0749/S	Supplied Fitted
6	Screw	PX0740/P	PX0740/S	Supplied Fitted
7	Screw	PX0746/P	PX0746/S	Supplied Fitted
9	Crimp	PX0729/P	PX0729/S	Supplied Loose
25	Crimp/Solder	PX0821/P	PX0821/S	Order Separately
50ΩBNC	Crimp		PX0743/S/50Ω	Supplied Loose
75ΩBNC	Crimp		PX0743/S/75Ω	Supplied Loose

Standard Buccaneer®



- Panel Mounting Connector
- Single Hole Fixing
- Pin or Socket Versions
- Poles 2, 3, 4, 6, 7, 9, 25 or BNC
- Mates with Flex Cable Connector

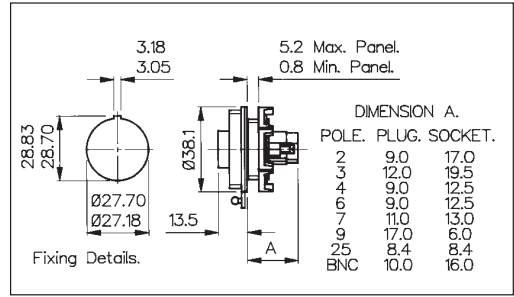

Poles	Termination	Pin Contacts	Socket Contacts	Contacts
2	Screw	PX0735/P	PX0735/S	Supplied Fitted
3	Screw	PX0730/P	PX0730/S	Supplied Fitted
4	Screw	PX0747/P	PX0747/S	Supplied Fitted
6	Screw	PX0738/P	PX0738/S	Supplied Fitted
7	Screw	PX0744/P	PX0744/S	Supplied Fitted
9	Crimp	PX0727/P	PX0727/S	Supplied Loose
25	Crimp/Solder	PX0822/P	PX0822/S	Order Separately
50ΩBNC	Crimp		PX0741/S/50Ω	Supplied Loose
75ΩBNC	Crimp		PX0741/S/75Ω	Supplied Loose



- Bulkhead Flange Mounting Connector
- Screw Fixing Flange
- Pin or Socket Versions
- Poles 2, 3, 4, 6, 7, 9, 25 or BNC
- Mates with Flex Cable Connector
- Supplied with sealing gasket and screw sealing grommets

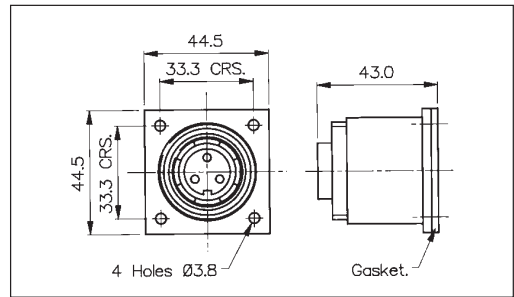

Poles	Termination	Pin Contacts	Socket Contacts	Contacts
2	Screw	PX0757/P	PX0757/S	Supplied Fitted
3	Screw	PX0756/P	PX0756/S	Supplied Fitted
4	Screw	PX0761/P	PX0761/S	Supplied Fitted
6	Screw	PX0758/P	PX0758/S	Supplied Fitted
7	Screw	PX0760/P	PX0760/S	Supplied Fitted
9	Crimp	PX0762/P	PX0762/S	Supplied Loose
25	Crimp/Solder	PX0823/P	PX0823/S	Order Separately
50ΩBNC	Crimp		PX0759/S/50Ω	Supplied Loose
75ΩBNC	Crimp		PX0759/S/75Ω	Supplied Loose



- Low Profile Flange Mounting Connector
- Screw Flange Fixing
- Pin or Socket Versions
- Poles 2, 3, 4, 6, 7, 9, 25 or BNC
- Mates with Flex Cable Connector
- Supplied with sealing gasket and screw sealing grommets

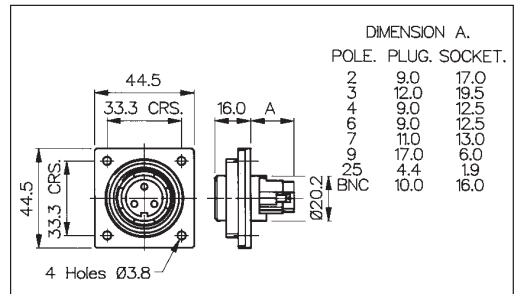

Poles	Termination	Pin Contacts	Socket Contacts	Contacts
2	Screw	PX0764/P	PX0764/S	Supplied Fitted
3	Screw	PX0765/P	PX0765/S	Supplied Fitted
4	Screw	PX0766/P	PX0766/S	Supplied Fitted
6	Screw	PX0767/P	PX0767/S	Supplied Fitted
7	Screw	PX0768/P	PX0768/S	Supplied Fitted
9	Crimp	PX0769/P	PX0769/S	Supplied Loose
25	Crimp/Solder	PX0824/P	PX0824/S	Order Separately
50ΩBNC	Crimp		PX0763/S/50Ω	Supplied Loose
75ΩBNC	Crimp		PX0763/S/75Ω	Supplied Loose

BULGIN Buccaneer® Connectors

Standard Buccaneer®

Buccaneer® Connectors



25 way inserts (Assembled)

- Contacts for 25 Way Inserts
- Crimp or Solder Pins and Sockets
- Gold Plated
- 1A, 50V

Contacts - Solder & Crimp

Contacts (Supplied in packs of 10)	Solder	Crimp
Pins	SA3180/1	SA3180
Sockets	SA3179/1	SA3179

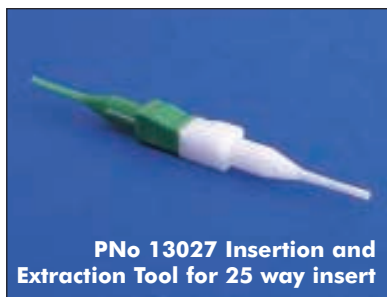

PN0 13027 Insertion and Extraction Tool for 25 way insert

- Insertion and Extraction Tool
- For Use with 25 Way Inserts

Tools

Crimp Tool (25 Way)	PNo. 13170
Crimp Tool (9 Way)	PNo. 13826
Insertion/Extraction Tool (25 Way)	PNo. 13027
Hex Cavities for BNC Inserts Centre Contact:	1.69 A/F (B.S. 'W'/ERMA XA)
Braid:	6.48 A/F (B.S. 'E'/ERMA XH)



BNC Inserts

- BNC Inserts
- 50 or 75 ohms available
- Fit all Standard Connector Versions

Cable Acceptance - Standard as supplied

No. Contacts	Cable Diameter
2-9 Pole	6-8mm
25 Pole	7-9mm
BNC	RG 58/CU, URM43, URM76, URM70

Cable Acceptance - Alternatives

Cable Diameter	Gland Part No.	Gland Colour	Additional Suffix
6-8mm	12023	Black	Standard for 2-9 pole
3.5-5mm	12023/5	Grey	Suffix /04
5-7mm	12023/1	White	Suffix /05
7-9mm	12023/2	Yellow	Suffix /07
Gland Pack	SA3253	Pack of 3 glands to suit cables 3.5-5mm, 5-7mm & 7-9mm dia	

To order connector with alternative cable gland add suffix to part no. e.g. PX0731/P/07 = PX0731 connector with cable gland to suit 7-9mm dia. cable.



Cap Assembly Tools

PX0733
Fits all other
types.

PX0734
Fits Flex
Mounting types.

- Sealing Cap/Assembly Tool
- Maintains IP68 Rating of Unmated Connectors
- Can be used to remove Inserts
- Two Styles, One for Flex Mount and One for Panel Mount & Flex In-Line Connector

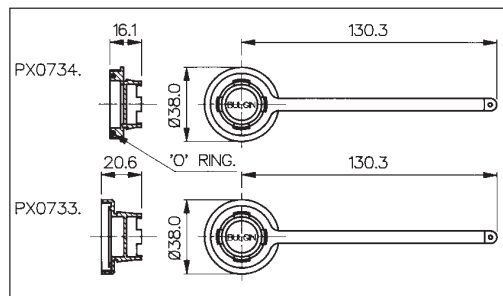

Standard Buccaneer®



Boot PNo. 12855

- PVC Insulation Boot
- Protects Rear of the Connector
- Flammability Rating UL94V-0
- Fits Panel Mount Versions only

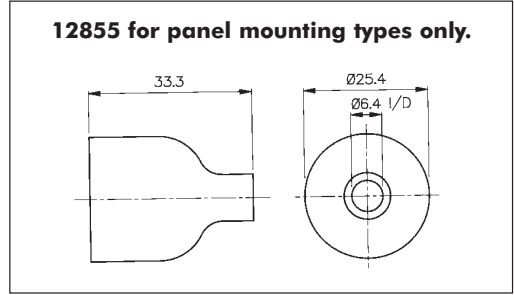

PNo. 12237
Cable Support Accessory

- Cable Support Accessory
- Gives Extra Support to the Cable
- Suitable for 5-7mm and 7-9mm Cable Diameters

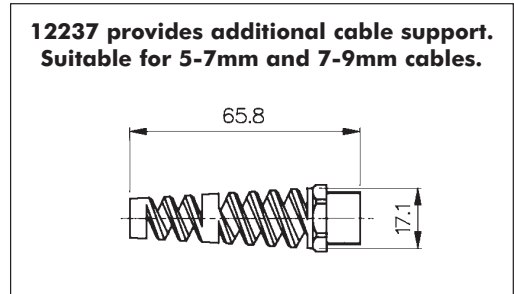

Buccaneer® Connectors

Specification

Electrical:		Mechanical:	
No Poles:	2, 3 4 6, 7 9 25	Sealing:	IP68, BS 5490 : 1977 Tested @ 15lb/sq.in. (10m depth) for 2 wks. BSEN 60529 : 1992 Tested @ 140lb/sq.in. (100m depth) for 12 hrs.
Current Rating:	10A 6A 3A 5A 1A	Cable Acceptance:	2-9 Pole - standard gland: 6-8mm dia 2-9 Pole - alternative glands: 3.5-9mm dia 25 Pole - standard gland: 7-9mm dim 25 Pole - alternative glands: 3.5-7mm dim
Voltage Rating (ac/dc):	250V 250V 250V 150V 50V	BNC 50Ω:	RG 58/CU, URM43 & URM76
Contact Resistance:	<10mΩ (2-9 Pole) <5mΩ (25 Pole)	BNC 75Ω:	URM70
Insulation Resistance:	>10*MΩ @ 500V d.c. (2-9 Pole)	Contact Accommodation:	2 and 3 pole: 4mm ² (12AWG) max 4, 6 and 7 pole: 1.5mm ² (16AWG) max 9 pole: 0.14-0.2mm ² 25 pole: 0.21-0.081mm ²
AC Breakdown voltage:	4kV Pole - Pole (2-9 Pole) 6kV Poles - Panel (Low Profile Flange and Panel Types - 2-9 Pole) 7.5kV Poles - Panel (Other Types - 2-9 Pole)	Terminations:	2-7 Pole: Screw Terminals 9 Pole: Crimp Contacts 25 Pole: Crimp & Solder Contacts
Operating Temp. Range:	-20°C to +70°C	Tightening Torques:	Flex Mounting/In-Line: Gland Nut; 1.13Nm (10lbf.in.) Panel Mounting: Rear Fixing Nut; 1.7Nm (15lbf.in.) Surface/Bulkhead and Low Profile Flange Mounting: 4 Fixing Screws (using washers supplied) 0.34Nm (3lbf.in.)
Approvals:		Sealings Caps/Locking Ring:	1.13Nm (10lbf.in.)
Material:			
Body Mouldings:	Glass Filled Polyamide UL94HB		
Inserts (2-9 pole):	Glass Filled Polyamide UL94HB		
Inserts (25 pole):	Polyamide UL94V-0		
Contacts:			
Screw Terminal:	Brass, Nickel Plated		
Crimp (9 pole):	Copper Alloy, Tin Plated		
Crimp/Solder (25 Pole):	Copper Alloy, Gold Plated (0.1µm on Nickel)		
BNC inserts:	Brass, Nickel Plated		
BNC contacts:	Brass, Silver Plated		

Sealed In-Line Cable Joiner

Buccaneer® Connectors



- IP68 Rating
- For Sealed In-Line Connections
- Standard Cable Acceptance 6-8mm
- Cable Range 3.5-9mm (using alternative glands)
- Supplied with 3 way Terminal Block
- Available Moulded in Black or Orange

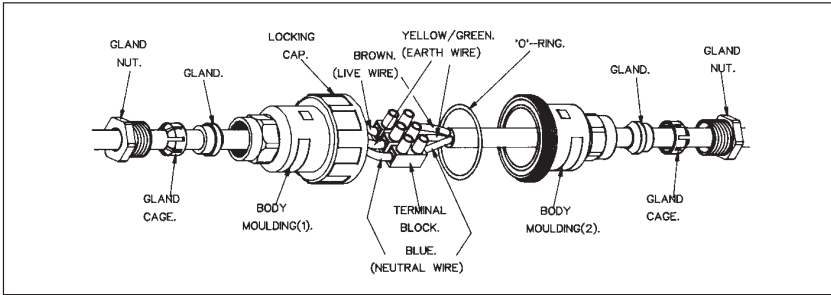
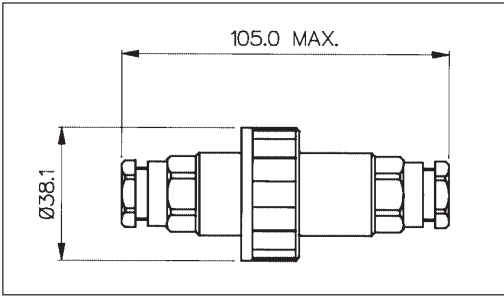

Specification	PX0777
Rating:	6A, 250V a.c.
Wire Termination:	3 way Terminal Block (2.5mm ² -14 AWG max)
Cable Acceptance:	6-8mm dia - standard gland 3.5-5mm, 5-7mm or 7-9mm dia - alternative glands
Material:	Glass Filled Polyamide UL94HB
Sealing:	IP68 to BSEN 60529 : 1977
Operating Temp. Range:	-20°C to +70°C
Colour:	Black Orange (Add /OR to P.No.)
BNC Cable Types:	50 ohm – RG58/CU, URM43 & URM76 For BNC version of PX0777 add /50OHM to P.No.

IP68

Mini Buccaneer®

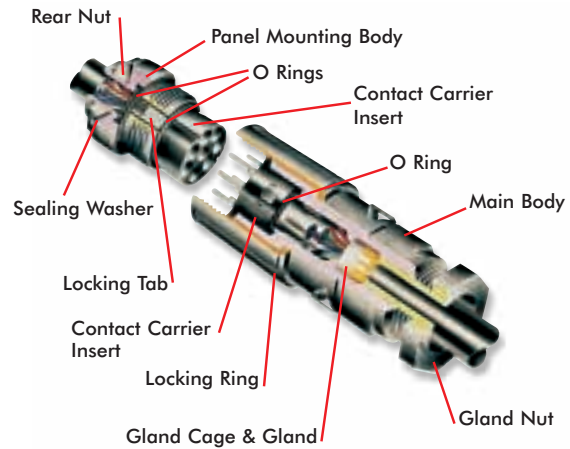

Buccaneer®
Connectors

- Diameter over coupling ring 26mm
- 2, 3, 4 or 6 pole screw terminal inserts
- 3 or 8 pole solder or crimp inserts
- 5 body styles, Flex, Flex In-Line, Panel (2 styles), Panel Side Entry
- 50Ω or 75Ω BNC inserts
- 5A, 380V a.c. 3 & 8 way solder/crimp terminals
- 10A, 250V a.c. 2 & 3 way screw terminals
- 6A, 250V a.c. 4 way screw terminal
- 3A, 250V a.c. 6 way screw terminal
- Plug or socket connection in each body style
- Cable range from 3.5mm - 9mm
- UL approval
- Water and dustproof to IP68 when mated
- IP68 rating tested at 15lb/sq in (10m depth) for 2 weeks
- Positive locating keyways - cannot be mis-connected
- Sealing caps available to maintain IP68 rating of unmated connectors
- Flammability rating UL94V-0 material
- Leading earth contact for 3 pole plug version
- Compact design
- Easy assembly - no special tools required on screw terminal versions

Mini Buccaneer®

Buccaneer® Connectors

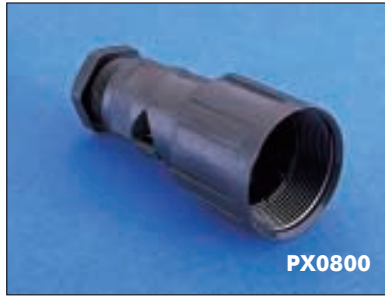

- Flex Cable Connector body
- Screw locking ring
- Mates with Flex In-line or Panel Mounting versions
- Suitable for Pin or Socket inserts
- Cap retaining clip for use with PX0811 sealing cap
- Cable Acceptance 3.5-9mm (Standard 5-7mm)

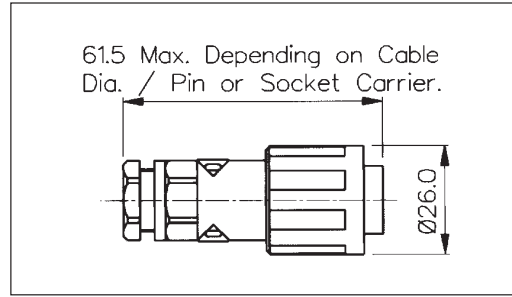

- In-line Flex Cable Connector body
- Mates with PX0800
- Suitable for Pin or Socket inserts
- Cap retaining clip for use with PX0810 sealing cap
- Cable Acceptance 3.5-9mm (Standard 5-7mm)

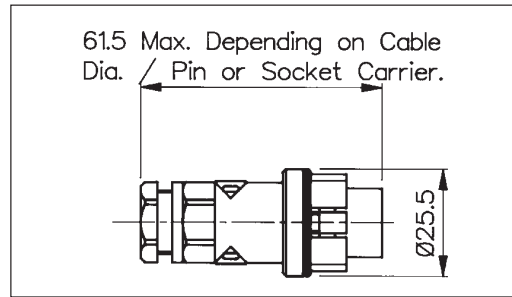

- Panel Mounting body
- Mates with PX0800
- Single hole fixing
- With cap retaining clip for use with PX0810 sealing cap
- Suitable for Pin or Socket inserts

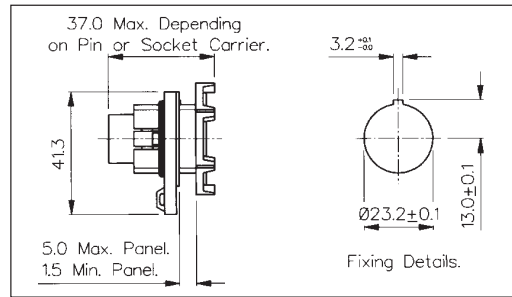

- Panel Mounting body
- Mates with PX0800
- Right angle cable entry
- Single hole fixing
- Suitable for Pin or Socket inserts

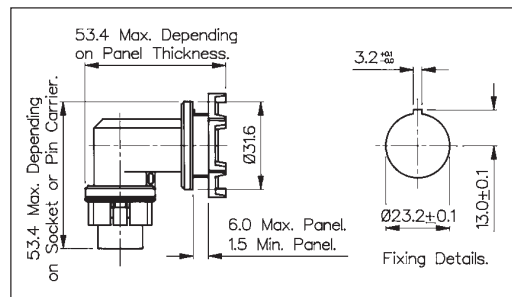

- Panel Mounting body
- Mates with PX0800
- PX0804 without sealing cap retaining clip, PX0805 with sealing cap retaining clip
- Single hole fixing
- Suitable for Pin or Socket inserts

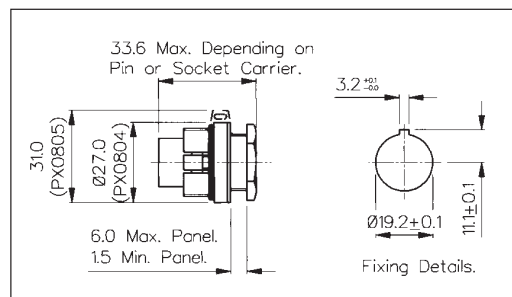

Mini Buccaneer®



Screw Terminal Inserts

- Screw Terminal Insert
- 2, 3, 4 and 6 Poles
- Fits all Body Styles
- Leading Earth Pin on 3, 4 and 6 pole inserts

Screw Terminal Inserts Fit all body styles.

No. Poles	Socket	Pin
2	SA3319	SA3320
3	SA3229	SA3230
4	SA3242	SA3241
6	SA3244	SA3243



Contact Carrier Inserts
shown fitted with contacts

- Contact Carrier Inserts
- For Solder or Crimp Contacts
- 3 or 8 Pin
- Fits all Body Styles
- Contacts Supplied Separately

Solder & Crimp Contact Carrier Inserts Fit all body styles.

No. Poles	Solder	Colour	Crimp	Colour
8 pin	12734/1	Black	12734	Grey
8 socket	12735/1	Black	12735	Grey
3 pin	12734/3/1	Black	12734/3	Grey
3 socket	12735/3/1	Black	12735/3	Grey



Contacts,
Polarising/Blanking Pins

Contacts - Solder & Crimp

Contacts (Supplied in packs of 10)	Solder	Crimp
Pins	SA3148/1	SA3148
Sockets	SA3149/1	SA3149
Polarising/Blanking Pins	SA3147	
Contact Insertion Tool: Must be used to load contacts into inserts.	SA3150	
Crimping Tool	SA2800	

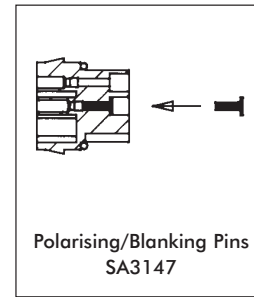

Polarising/Blanking Pins
SA3147



BNC Inserts
Shown Assembled

BNC Inserts Fit all body styles except PX0803.

Impedance	Cable Type	Contacts	Part No.
50Ω	RG58/CU, URM43, URM76	Plug	SA3159/1
50Ω	RG58/CU, URM43, URM76	Socket	SA3157/1
75Ω	URM70	Plug	SA3159
75Ω	URM70	Socket	SA3157



Sealing Caps
To maintain IP rating

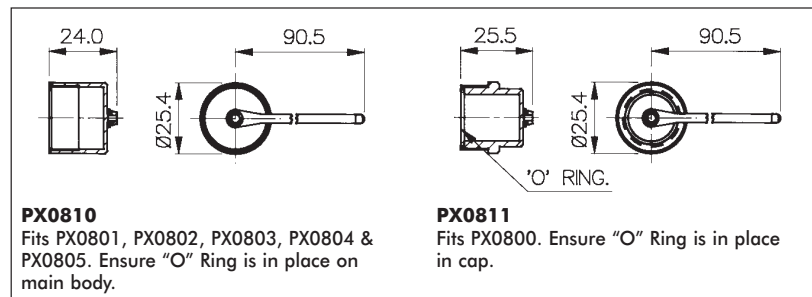

Mini Buccaneer® Contact Inserts and Accessories

Specification

Electrical	Solder/Crimp Terminals	Screw Terminals	BNC
No Poles:	3, 8	2, 3 4 6	
Current Rating:	5A	10A 6A 3A	
Voltage Rating:	380V ac	250V ac 250V ac 250V ac	
Contact Resistance:	<5mΩ		
Insulation Resistance:	>10 ⁴ MΩ @ 500V d.c.		
Voltage Proof:	2kV @ 50Hz		
Operating Temp. Range:	-20°C to +70°C		
Approvals:			
Materials	Solder/Crimp Terminals	Screw Terminals	BNC
Body Mouldings:	Polyamide UL94V-0		
Inserts:	Polyamide UL94V-0		
Contacts:	Copper Alloy, Gold Plated (0.1μm) on Nickel	Brass, Nickel Plated	Brass, Silver Plated.
O Rings:	Nitrile		
Mechanical	Solder/Crimp Terminals	Screw Terminals	BNC
Sealing:	Protection Classification IP68, BS EN60529:1992. Tested @ 15lb/sq.in. (10m depth) for 2 wks.		
Cable Acceptance	5-7mm dia - standard gland 3.5-9mm dia - alternative glands		
Contact Accomodation:	0.2 - 0.5mm ² (20 - 24 AWG)	1mm ² max (18 AWG)	50Ω: RG58/CU, URM43, URM76 75Ω: URM70
Insertion Force (typical):	3 way: 5N (1.1lbf) 8 way: 14N (3.1lbf)	3 way: 45N (10lbf) 4 way: 50N (11lbf) 6 way: 140N (31lbf)	
Withdrawal Force (typical):	3 way: 3N (0.66lbf) 8 way: 12N (2.6lbf)	3 way: 32N (7lbf) 4 way: 40N (9lbf) 6 way: 150N (34lbf)	
Tightening Torques			
Gland Nut, PX0800, 801:	1.13Nm (10lbf in)		
Rear Nut, PX0802, 803, 804, 805:	0.7Nm min, 1.7Nm max (6.2lbf in min, 15lbf in max)		
Sealing Cap, PX0810, 811:	0.23Nm min, 1.13Nm max (2lbf in min, 10lbf in max)		

How To Order

- 1 Choose Body Type.
- 2 Determine Contact Carrier Inserts. Choose number poles, and type of contacts (solder, crimp, screw terminal or BNC).
- 3 Choose Pins or Sockets. Solder and crimp contacts are supplied separately in packs of ten.
- 4 Choose Polarising/Blanking Pins. If required for solder/crimp contact inserts. Supplied in packs of ten.
- 5 Contact Insertion Tool (required to load solder/crimp contacts into inserts).
- 6 Crimping Tool (if required for crimp contacts).
- 7 Sealing Cap (if required).

Cable Acceptance

Cable gland for 5-7mm fitted as standard.

Cable Diameter	Gland Part No.	Gland Colour	Additional Suffix
5-7mm	12023/1	White	Fitted as standard
3.5-5mm	12023/5	Grey	Suffix /04
6-8mm	12023	Black	Suffix /06
7-9mm	12023/2	Yellow	Suffix /07

To order body with alternative cable gland add suffix to part no. e.g.
PX0800/06 = PX0800 body with cable gland to suit 6-8mm dia. cable.

400 Series Buccaneer®

IP68

Buccaneer®
Connectors

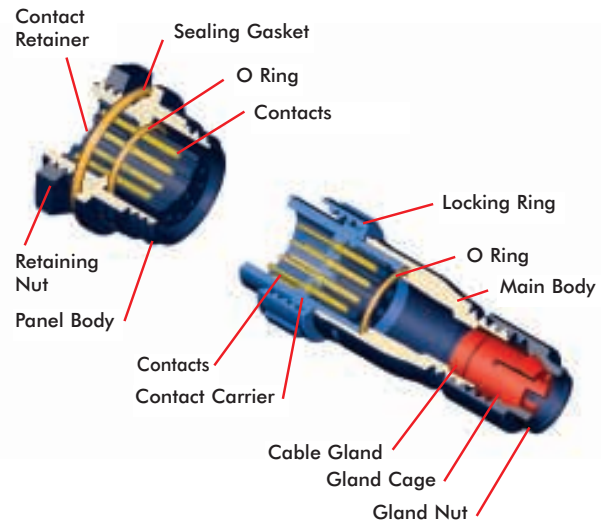

- Diameter over coupling ring 19.1mm
- 2 and 3 pole - 8A, 250V rating
- 4, 6 and 8 pole - 5A, 125V rating
- 10 and 12 pole - 1A, 50V rating
- 2.5mm contact engagement for electrical integrity
- 'Scoop proof' contacts
- Contact inserts are part of body moulding
- Cable range from 3 to 7mm
- Overall length (flex + flex in-line) 80mm
- UL and VDE approvals
- Flex, Flex In-Line, and Panel mounting body styles
- Plug and Socket versions in all body styles
- Sealed to IP68 when mated
- IP68 rating tested at 15lb/sq in (10m depth) for 2 weeks
- Flame Retardant moulding material - Polyamide UL94-V0
- Contacts supplied separately
- Sealing caps available to maintain IP68 rating
- Secure sealing system
- Crimp and solder contacts

BULGIN Buccaneer® Connectors

400 Series Buccaneer®

Buccaneer® Connectors



- Flex Cable Connector
- Screw locking ring
- Mates with Flex In-line or Panel mounting versions (PX0411 & PX0412)
- Contacts supplied separately

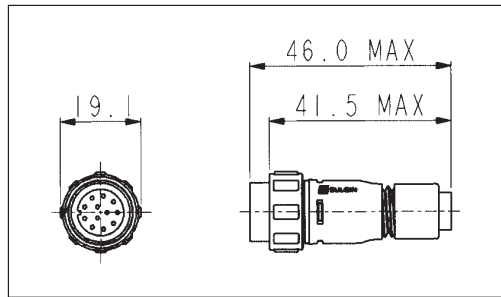

- In-line Flex Cable Connector
- Screw locking ring
- Mates with PX0410
- Contacts supplied separately

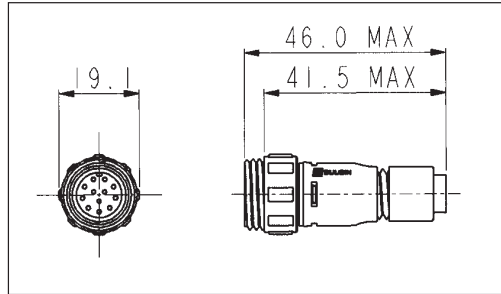

- Panel Mounting Connector
- Single hole fixing
- Mates with PX0410
- Contacts supplied separately

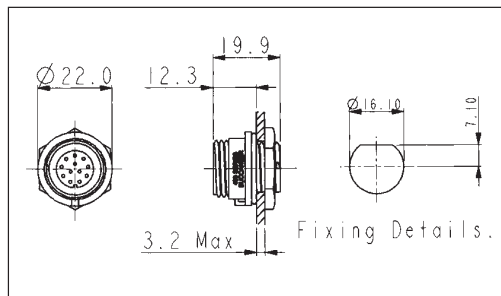

Contact layout

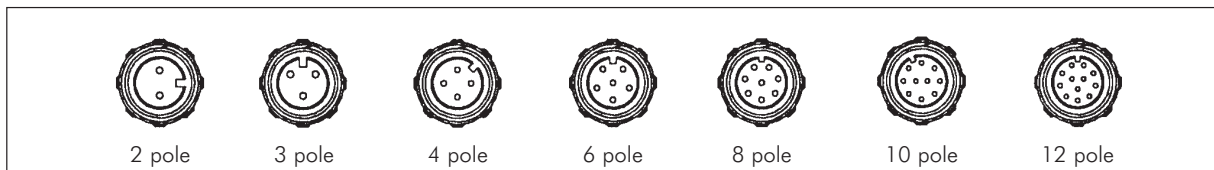

- PX0480**
Fits PX0412 style (panel body).
- PX0480/1**
Fits PX0411 style (flex in-line).
- PX0481**
Fits PX0410 style (flex body).

Gland Packs

- PX0482** Pack of 4 pairs cable collets and seals to suit cables from 3.0 to 5.0mm diameter.
- PX0483** Pack of 4 pairs cable collets and seals to suit cables from 5.0 to 7.0mm diameter.

Part No System

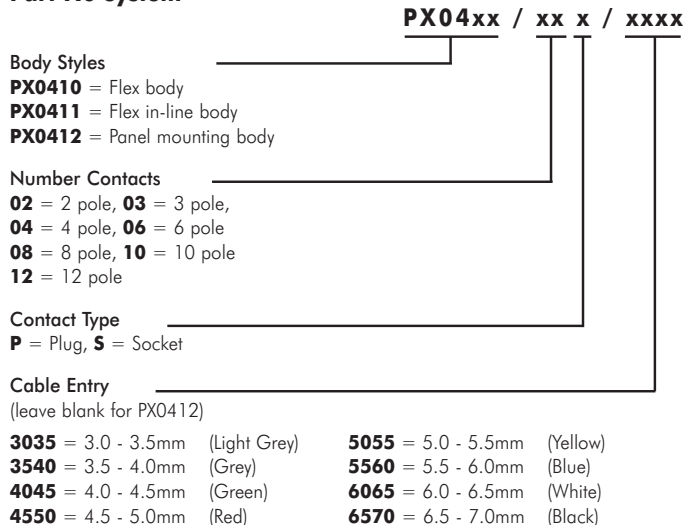

Ordering Information

- Determine body style, i.e. PX0410 = flex body, PX0411 = flex in-line body
- Determine number of contacts & type, i.e. 02 = 2 way, P = pin contacts
- Determine cable range, i.e. 3035 = 3.0 to 3.5mm cable accomation
- Choose appropriate contacts pack, i.e. SA3350 = pin contacts suitable for 2 & 3 way connectors, supplied in pack quantities of 10
- Is a sealing cap required?
- Is an insertion tool required?
- Is a crimp tool required?

Configuration

- Crimp contacts supplied separately in packs (see table below)
- Solder contacts supplied separately in packs (see table below)
- Supplied with colour coded sealing glands for specified cable range
- Separate gland packs available
- Contact inserts are part of body moulding - no assembly required
- Sealing caps supplied separately

Crimp Contacts

Pole	Pin	Socket	Pack Qty	Cable Acceptance (dia)	Current Rating
2, 3	SA3350	SA3349	10	20 - 24 AWG	8A
4, 6, 8	SA3348	SA3347	10	22 - 26 AWG	5A
10, 12	SA3180	SA3179	10	24 - 28 AWG	1A

Solder Contacts

Pole	Pin	Socket	Pack Qty	Cable Acceptance (dia)	Current Rating
2, 3	SA3350/1	SA3349/1	10	20 - 24 AWG	8A
4, 6, 8	SA3348/1	SA3347/1	10	22 - 26 AWG	5A
10, 12	SA3180/1	SA3179/1	10	24 - 28 AWG	1A

Contact Insertion Tools

	Contact rating	Colour	Part No
Insertion/Extraction Tool	1A	Green	13027
Insertion/Extraction Tool	5A	Red	13027/1
Insertion/Extraction Tool	8A	Blue	13027/2

Crimp Tools

	Contact rating	Colour	Part No
Positioner	1A	Green	14025/1AMP
Positioner	5A	Red	14025/5AMP
Positioner	8A	Blue	14025/8AMP
8 Indent Crimp Tool for use with positioners			14025

400 Series Buccaneer®



Specification

Electrical:

Poles:	2, 3	4, 6, 8	10, 12
Current Rating:	8A	5A	1A
Voltage Rating:	250V	125V	50V
Contact Resistance:	<5mΩ		
Insulation Resistance:	>10 ⁶ MΩ (@ 500V a.c.)		
AC Breakdown Voltage:	2.5kV		
Operating Temperature Range:	-40° to +80°C		
Approvals:			

* pending

Material:

Body Mouldings:	Polyamide
Flammibility Rating:	UL94V-0
UV Resistance:	To EN 50021:1999
Contacts:	Copper alloy, Gold plated
O Rings:	Nitrile
Panel Sealing O Ring:	Nitrile

Mechanical:

Sealing:	IP68, EN 60529 tested @ 15lb/sq in (10m depth for 2 wks)
Cable Acceptance:	3.0 - 7.0mm
Contact Accommodation:	2, 3 pole, 20 - 24 AWG 4, 6, 8 pole, 22 - 26 AWG 10, 12 pole, 24 - 28 AWG
Termination:	Crimp and solder
Insertion/Withdrawal Force:	
No. poles:	2 3 4 6 8 10 12
Insertion Force (typ):	19N 25N 27N 27N 28N 55N 62N
Withdrawal Force (typ):	12N 17N 17N 21N 22N 25N 29N
Cable Retention force:	80N

Dimensions:

Overall dimensions of connectors when mated together	
Flex + Flex In-Line	80mm
Dia. over coupling ring	19.1mm