







DASH NO	CABLES ACCOMMODATED	ASSEMBLE PER
-23	275-3930, MICRODOT	TAI-127
-24	202-3934, MICRODOT	TAI-125
-24A	9530A5117, RAYCHEM	TAI-127
-27	202-3927, MICRODOT  73-1317911-1, SYLVANIA	TAI-125
-29	TWC-124-1A TWC-78-1	TAI-125
-30	8441, BELDEN  761A, W.E.CO.	TAI-125
-32	TRC-50-1	TAI-127
-33	TRC-75-1	TAI-127
-43	250-4044/250-4045 293-3930 MICRODOT	TAI-174
-45	10602, RAYCHEM	TAI-125
-47	M17/176-00002 	TAI-125
-49	TWAC-78-1F2 	TAI-125
-55	GC875GC1, GRUMMAN	TAI-174
-57	GC875GB1, GRUMMAN	TAI-174
-58	GC875TM24H, GRUMMAN	TAI-125
-55	TWCP-124-3	TAI-125

REVISIONS		310-0036	SH 1
REV	DESCRIPTION	DATE	APPROVED
V	REVISED PER ECD 15485	2/14/04	

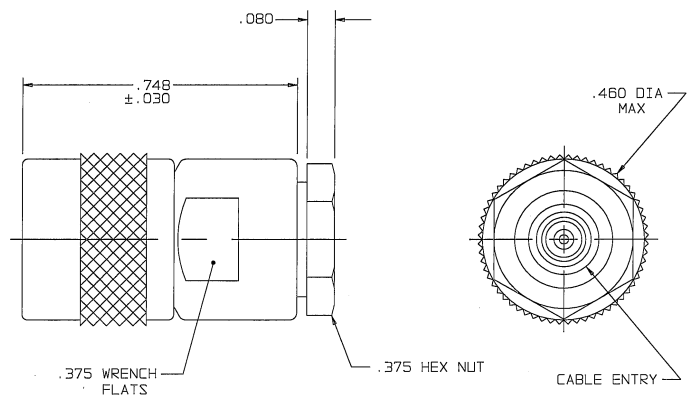

-29 SHOWN

**RED INDICATES ORIGINAL**

-  .187 LG JACKET SLITS MAY BE REQUIRED FOR EASE OF ASSY
-  NOT WRENCH CRIMP
- 3. CONCENTRIC TWINAX/TRIAX SUBMINIATURE 3-LUG TRS PLUG
- 2. FINISH: TFS-1A (NICKEL)
- 1. ALL DIM ARE IN INCHES

310-0028		AAH	B-10-04	MATERIAL:		TITLE:	
305-0374		CHERRY	6-10-04	FINISH:		PL 155	
3-0040		PLATE	01/11/04	SCALE:		DRAWING NO. 310-0036	
3-0029		PLATE	01/11/04	DATE:		REV. V	
205-0029		PLATE	01/11/04	SCALE:		DRAWING NO. 310-0036	
1-0451		PLATE	01/11/04	DATE:		REV. V	
NEXT ASSY		310-0036V	00	SCALE:		DRAWING NO. 310-0036	

