



SMA COAXIAL CONNECTORS

The Connex SMA connectors are semi-precision, sub-miniature, high-frequency connectors which offer reliable broadband performance DC to 18GHz with low reflection and constant 50 ohm impedance.

The main features are high mechanical strength, high durability and low VSWR. Matured design principles, careful manufacturing at all stages and a thorough quality assurance organization are the bases for the well-known quality of Connex SMA connectors.

ELECTRICAL SPECIFICATIONS

Impedance	50 ohm		
Frequency range	*Semi-rigid cable for .141" or .085" O.D. copper jacket: 0–18 GHz *Flexible cable: 0–12.4 GHz		
Voltage rating	*RG–58, 141, 142, 223: 500v peak *RG–174, 188, 316: 375V peak		
Dielectric withstanding voltage	*.141" & RG–58 cable group: 1000V RMS * .085" & RG–316 cable group: 750V RMS		
VSWR—straight Connectors *f in GHz	*.141" semi-rigid cable group: 1.05 + .005f	*RG–58 cable group: 1.15 + .01f	*RG–178 cable group: 1.20 + .025f
Insulation resistance	5000 Megohms		
RF leakage	-90 db min. at 2–3 GHz		
Insertion loss	db max. = .06√freq. GHz.. Test frequency @6.0 GHz		
Contact resistance	Center: 2.0 milliohms	Body: 2.0 milliohms	Braid to body: 0.5 milliohms

MILITARY SPECIFICATIONS
MIL–C–39012 & MIL–C–83517 SMA

MATERIAL SPECIFICATIONS

PARTS NAME		MIL STANDARD	ECONOMIC TYPE
Body, coupling nut, other metal parts		Non-magnetic stainless steel per QQ–S–764 #303 finish: passivated	Brass per QQ–B–626 finish: nickel or gold per requirement
Contacts	Male	Brass per QQ–B–626	Brass per QQ–B–626
	Female	Beryllium copper per QQ–C–530 heat treated per MIL–H–7199	Beryllium copper per QQ–C–530 heat treated per MIL–H–7199
		Finish: .00005" min gold plated per MIL–G–45204 type 1, Grade C.	Finish: .00005" min gold plated per MIL–G–45204 type 1, Grade C.
Insulator		PTFE	PTFE
Gasket		Silicone rubber	Silicone rubber
Crimp ferrule		Seamless copper tubing alloy	Seamless copper tubing alloy
Selection Guide		*Suitable for direct mounting on aluminium panels *Lowest cost	*For commercial application only *Lower cost

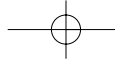

SMA COAXIAL CONNECTORS

All connectors listed, unless otherwise noted, are Commercial Grade construction, gold-plated brass bodies with 50 μ gold contacts. All insulators are teflon. All other parameters are equal to Mil Standard construction.

Mil Standard connectors, i.e. Stainless Steel body, available upon request as per material specifications listed in Material section on preceding page.

All dimensions in millimeters and [inches].

C A B L E G R O U P L E G E N D					
01	58/ 58A/ 58C/ 141/ 303/ LMR195™/ B7806A	06A	179/ U DOUBLE BRAIDED	09	B8227/ 89207
01A	55/ 142/ 223/ 400	07	8/ 8A/ 213/ 393	10	.141 SEMI-RIGID/ 402/U
01B	LMR200™/ B7807A	07A	214	11	.085 SEMI-RIGID/ 405/U
02	58 PLENUM/THINNET/ 122U/ B88240/ B89907	07B	8X/ LMR240™/ B7808A	12	.250 SEMI-RIGID
03	59/ 62/ 140/ 210	07C	B9913/ LMR400™/ B7810A/ B8214	13	.047 SEMI-RIGID/ B1674A
03A	59/ U-20AWG	07D	B89913	14	178/ 196
04	59/ U PLENUM	07E	11	15	B8281/ B9231/ B9141
04A	59/ U PLENUM-20AWG	07F	11/ U-14AWG/ B8213/ B9292/ B7731/ B1859A	15A	B88281
05	174/ 188A/ 316/ B7805A	08	6/ 143/ 212	16	180/ 195/ 122/ B8218/ B1865A/ B1855
05A	316/ U DOUBLE BRAIDED	08A	B1694A/ B9248	17	LMR600™
06	179/ 187/ B9221	08B	6 PLENUM/ B1695A	18	AT&T734A/ B1505A
				19	AT&T735A/ B735A1

DIRECT SOLDER FOR SEMI-RIGID .047", .085" AND .141" CABLE

STRAIGHT CABLE PLUG — CABLE CENTER CONTACT

P.N.	Cable Group	Finish	Insulation	Impedance	Crimp Tool
132100	10	Gold	N/A	50	N/A
132100SS	10	S/S STAINLESS STEEL	N/A	50	N/A
132266	10	Gold SHORT PROFILE	N/A	50	N/A
132266SS	10	S/S STAINLESS STEEL, SHORT PROFILE	N/A	50	N/A

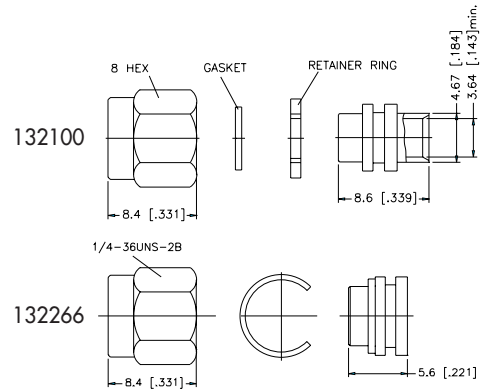

STRAIGHT CABLE PLUG — WITH CONTACT

P.N.	Cable Group	Finish	Insulation	Impedance	Crimp Tool
132101	11	Gold	Teflon	50	N/A
132102	10	Gold	Teflon	50	N/A
132200	10	Gold STAINLESS STEEL	Teflon	50	N/A
132248	11	Gold STAINLESS STEEL NUT	Teflon	50	N/A
132296	12	Gold	Teflon	50	N/A
132249	13	Gold	Teflon	50	N/A
132290	10	Gold CONTACT IN BODY	Teflon	50	N/A
132294	11	Gold CONTACT IN BODY	Teflon	50	N/A
132290-10	10	Gold EXTENDED BODY	Teflon	50	N/A
132294-10	11	Gold EXTENDED BODY	Teflon	50	N/A

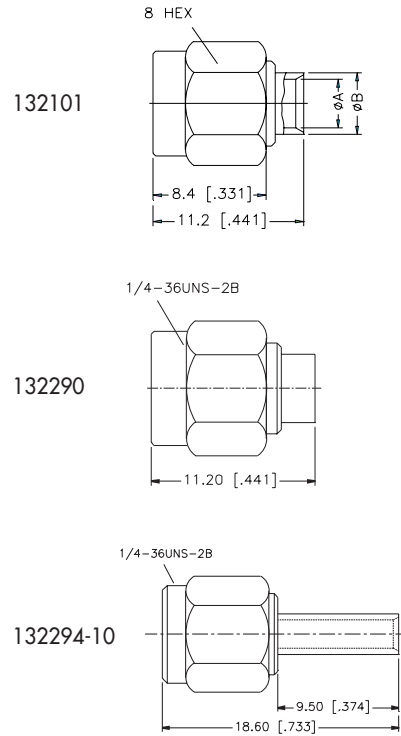

Cable: .047" Cable, A = 1.24 mm [.049"] min, B = 3.0 mm [.118"] min
 .085" Cable, A = 2.2 mm [.087"] min, B = 3.0 mm [.118"] min
 .141" Cable, A = 3.6 mm [.142"] min, B = 4.6 mm [.181"] min

For Reverse Polarized connectors, add RP to standard part number. Contact Connex marketing for availability.
 For Reverse Threaded connectors, add RT to standard part number. Contact Connex marketing for availability.
 For Crimp Tool information, see page 183.

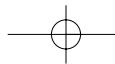

DIRECT SOLDER FOR SEMI-RIGID .047", .085" AND .141" CABLE

For Cable Group Legend, see page 27

STRAIGHT CABLE PLUG — WITH CONTACT — TORQUE NUT

P.N.	Cable Group	Finish	Insulation	Impedance	Crimp Tool
132179	10	Gold	Teflon	50	N/A
STAINLESS STEEL NUT					
132188	11	Gold	Teflon	50	N/A
STAINLESS STEEL NUT					

Cable: .047" Cable, A = 1.24 mm [.049"] min,
B = 3.0 mm [.118"] min
.085" Cable, A = 2.2 mm [.087"] min,
B = 3.0 mm [.118"] min
.141" Cable, A = 3.6 mm [.142"] min,
B = 4.6 mm [.181"] min

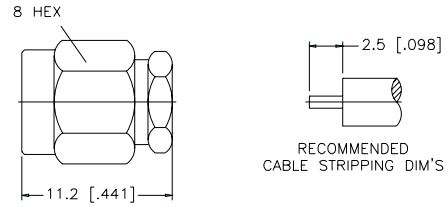
**RIGHT ANGLE CABLE PLUG DC — 12.4 GHz**

P.N.	Cable Group	Finish	Insulation	Impedance	Crimp Tool
132112	10	Gold	Teflon	50	N/A
132201	10	Gold	Teflon	50	N/A
STAINLESS STEEL NUT					
132111	11	Gold	Teflon	50	N/A
132250	13	Gold	Teflon	50	N/A

Cable: .047" Cable, A = 1.24 mm [.049"] min,
B = 3.0 mm [.118"] min
.085" Cable, A = 2.2 mm [.087"] min,
B = 3.0 mm [.118"] min
.141" Cable, A = 3.6 mm [.142"] min,
B = 4.6 mm [.181"] min

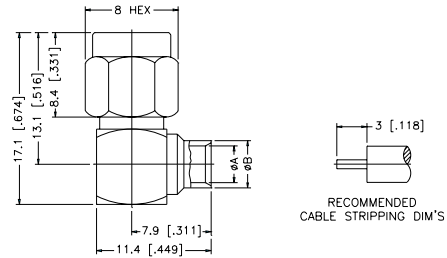
**STRAIGHT CABLE JACK**

P.N.	Cable Group	Finish	Insulation	Impedance	Crimp Tool
132104	10	Gold	Teflon	50	N/A
132103	11	Gold	Teflon	50	N/A
132257	13	Gold	Teflon	50	N/A

Cable: .047" Cable, A = 1.24 mm [.049"] min,
B = 3.0 mm [.118"] min
.085" Cable, A = 2.2 mm [.087"] min,
B = 3.0 mm [.118"] min
.141" Cable, A = 3.6 mm [.142"] min,
B = 4.6 mm [.181"] min

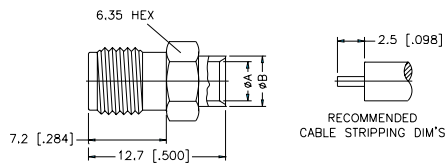
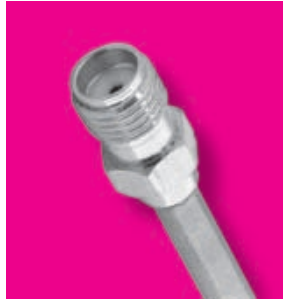
**BULKHEAD FEEDTHROUGH CABLE JACK — O-RING SEAL**

P.N.	Cable Group	Finish	Insulation	Impedance	Crimp Tool
132106	10	Gold	Teflon	50	N/A
132105	11	Gold	Teflon	50	N/A
132251	13	Gold	Teflon	50	N/A
132273	13	Gold	Teflon	50	N/A
EXTENDED BODY .725"					

Cable: .047" Cable, A = 1.24 mm [.049"] min,
B = 3.0 mm [.118"] min
.085" Cable, A = 2.2 mm [.087"] min,
B = 3.0 mm [.118"] min
.141" Cable, A = 3.6 mm [.142"] min,
B = 4.6 mm [.181"] min

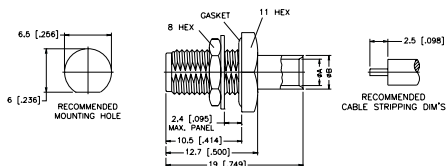
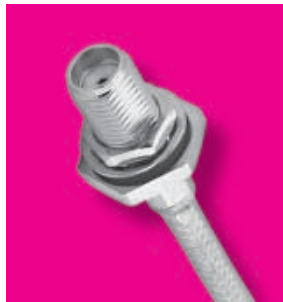

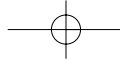

DIRECT SOLDER FOR SEMI-RIGID .047", .085" AND .141" CABLE

For Cable Group Legend, see page 27

PANEL MOUNT CABLE JACK — 4 HOLE SQUARE FLANGE

P.N.	Cable Group	Finish	Insulation	Impedance	Crimp Tool
132107	11	Gold	Teflon	50	N/A
132108	10	Gold	Teflon	50	N/A
132252	13	Gold	Teflon	50	N/A

Cable: .047" Cable, A = 1.24 mm [.049"] min,
B = 3.0 mm [.118"] min

.085" Cable, A = 2.2 mm [.087"] min,
B = 3.0 mm [.118"] min

.141" Cable, A = 3.6 mm [.142"] min,
B = 4.6 mm [.181"] min

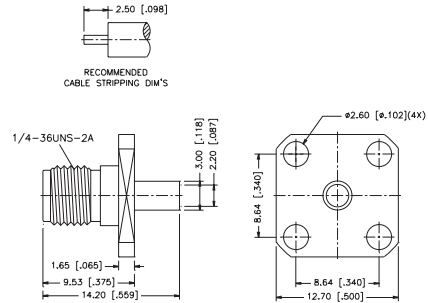

PANEL MOUNT CABLE JACK — 2 HOLE FLANGE

P.N.	Cable Group	Finish	Insulation	Impedance	Crimp Tool
132109	11	Gold	Teflon	50	N/A
132110	10	Gold	Teflon	50	N/A
132253	13	Gold	Teflon	50	N/A

Cable: .047" Cable, A = 1.24 mm [.049"] min,
B = 3.0 mm [.118"] min

.085" Cable, A = 2.2 mm [.087"] min,
B = 3.0 mm [.118"] min

.141" Cable, A = 3.6 mm [.142"] min,
B = 4.6 mm [.181"] min

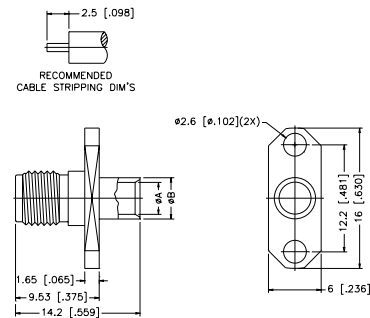

RIGHT ANGLE PANEL MOUNT CABLE JACK — 4-HOLE SQUARE FLANGE

P.N.	Cable Group	Finish	Insulation	Impedance	Crimp Tool
132293	11	Gold	Teflon	50	N/A
132292	10	Gold	Teflon	50	N/A

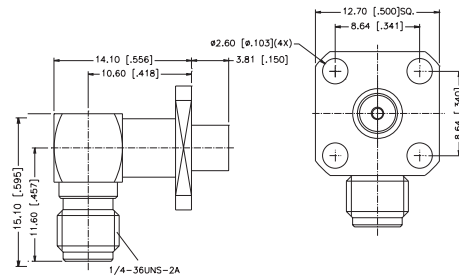

RIGHT ANGLE PANEL MOUNT CABLE JACK — 2-HOLE FLANGE

P.N.	Cable Group	Finish	Insulation	Impedance	Crimp Tool
132325	11	Gold	Teflon	50	N/A
132324	10	Gold	Teflon	50	N/A

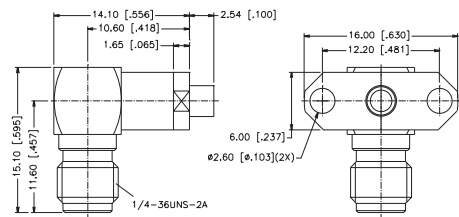
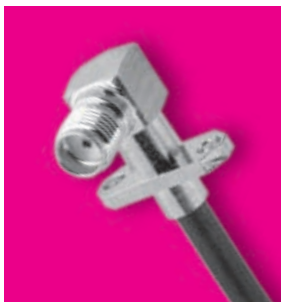

For Reverse Polarized connectors, add RP to standard part number. Contact Connex marketing for availability.
For Reverse Threaded connectors, add RT to standard part number. Contact Connex marketing for availability.
For Crimp Tool information, see page 183.

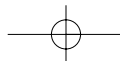

CRIMP TERMINATIONS FOR FLEXIBLE CABLE

For Cable Group Legend, see page 27

STRAIGHT CRIMP PLUG — STANDARD CABLE

P.N.	Cable Group	Finish	Insulation	Impedance	Crimp Tool
132113	01	Gold	Teflon	50	A
132195	01A	Gold	Teflon	50	A
132234	01B	Gold	Teflon	50	A
132231	07B	Gold	Teflon	50	A
132298	07C	Gold	Teflon	50	L

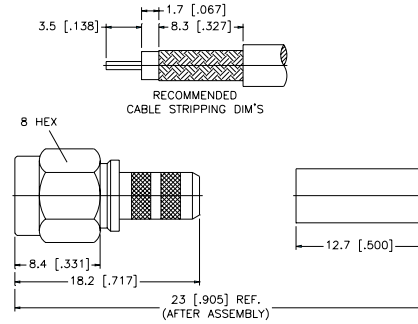
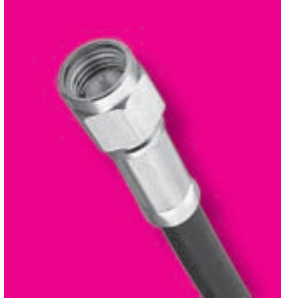

STRAIGHT CRIMP PLUG — MINIATURE CABLE

P.N.	Cable Group	Finish	Insulation	Impedance	Crimp Tool
132114	05	Gold	Teflon	50	B
132114SS	05	Gold	Teflon	50	B
STAINLESS STEEL					
132174	05	Gold	Teflon	50	B
STAINLESS STEEL NUT					
132178	05A	Gold	Teflon	50	C
132193	14	Gold	Teflon	50	B
132242	16	Gold	Teflon	50	B

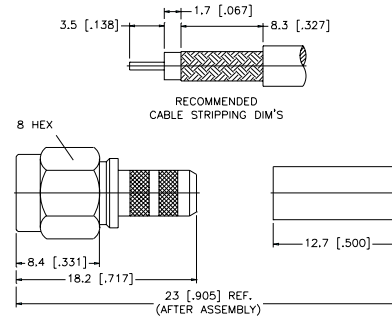

RIGHT ANGLE CRIMP PLUG — STANDARD CABLE

P.N.	Cable Group	Finish	Insulation	Impedance	Crimp Tool
132122	01	Gold	Teflon	50	A
132122SS	01	Gold	Teflon	50	A
STAINLESS STEEL					
132194	01A	Gold	Teflon	50	A
132235	01B	Gold	Teflon	50	A
132239	07B	Gold	Teflon	50	A
132299	07C	Gold	Teflon	50	L

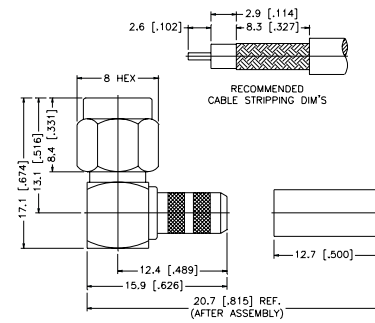

RIGHT ANGLE CRIMP PLUG — MINIATURE CABLE

P.N.	Cable Group	Finish	Insulation	Impedance	Crimp Tool
132123	05	Gold	Teflon	50	B
132182	05A	Gold	Teflon	50	C
132173	14	Gold	Teflon	50	B
132272	16	Gold	Teflon	50	B

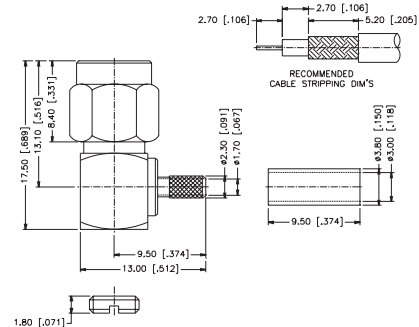

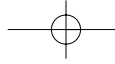

CRIMP TERMINATIONS FOR FLEXIBLE CABLE

For Cable Group Legend, see page 27

PANEL CRIMP JACK — STANDARD CABLE

P.N.	Cable Group	Finish	Insulation	Impedance	Crimp Tool
132120	01	Gold	Teflon	50	A
132254	01A	Gold	Teflon	50	A

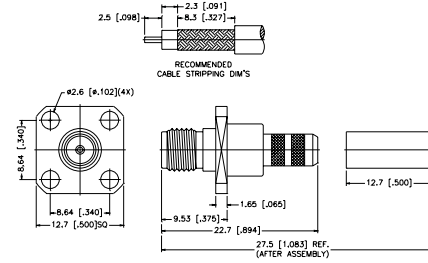

PANEL CRIMP JACK — MINIATURE CABLE

P.N.	Cable Group	Finish	Insulation	Impedance	Crimp Tool
132121	05	Gold	Teflon	50	B
132199	05A	Gold	Teflon	50	C

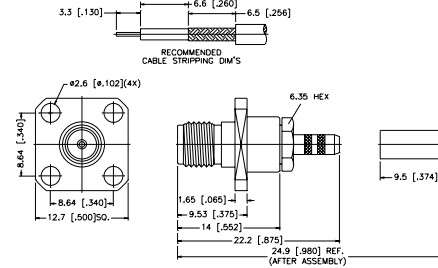

RIGHT ANGLE PANEL JACK — 4-HOLE FLANGE

P.N.	Cable Group	Finish	Insulation	Impedance	Crimp Tool
132326	05	Gold	Teflon	50	B
132321	05A	Gold	Teflon	50	C
132327	14	Gold	Teflon	50	B

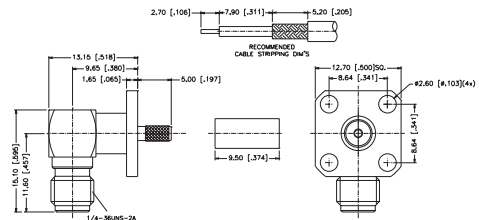
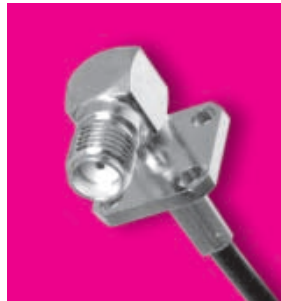

RIGHT ANGLE PANEL JACK — 2-HOLE FLANGE

P.N.	Cable Group	Finish	Insulation	Impedance	Crimp Tool
132328	05	Gold	Teflon	50	B
132329	05A	Gold	Teflon	50	C
132330	14	Gold	Teflon	50	B

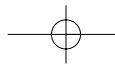
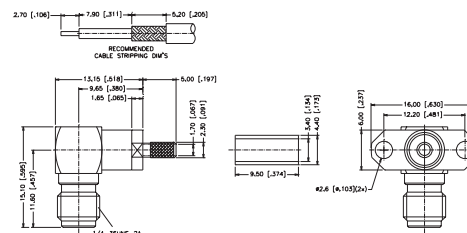
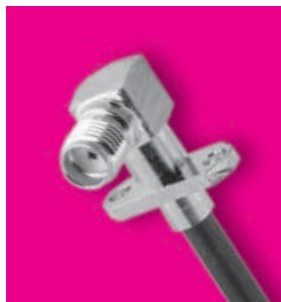

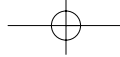

CLAMP TERMINATIONS FOR FLEXIBLE CABLE

For Cable Group Legend, see page 27

STRAIGHT CLAMP PLUG — STANDARD CABLE

P.N.	Cable Group	Finish	Insulation	Impedance	Crimp Tool
132125	01	Gold	Teflon	50	N/A

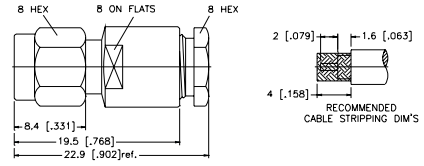

STRAIGHT CLAMP PLUG — MINIATURE CABLE

P.N.	Cable Group	Finish	Insulation	Impedance	Crimp Tool
132124	05	Gold	Teflon	50	N/A

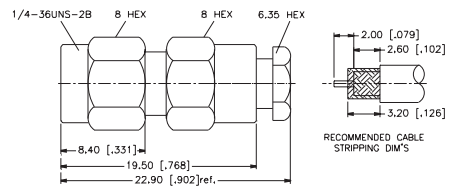

For Reverse Polarized connectors, add RP to standard part number. Contact Connex marketing for availability.
 For Reverse Threaded connectors, add RT to standard part number. Contact Connex marketing for availability.
 For Crimp Tool information, see page 183.

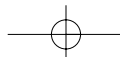

CLAMP TERMINATIONS FOR FLEXIBLE CABLE

For Cable Group Legend, see page 27

STRAIGHT CLAMP JACK — STANDARD CABLE

P.N.	Cable Group	Finish	Insulation	Impedance	Crimp Tool
132127	01	Gold	Teflon	50	N/A

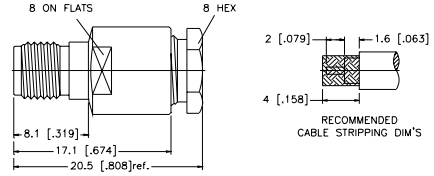

STRAIGHT CLAMP JACK — MINIATURE CABLE

P.N.	Cable Group	Finish	Insulation	Impedance	Crimp Tool
132126	05	Gold	Teflon	50	N/A

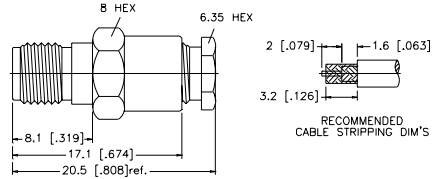

BULKHEAD CLAMP JACK — STANDARD CABLE

P.N.	Cable Group	Finish	Insulation	Impedance	Crimp Tool
132129	01	Gold	Teflon	50	N/A

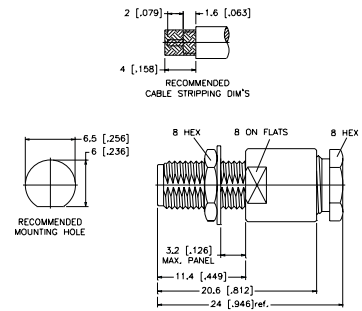

BULKHEAD CLAMP JACK — MINIATURE CABLE

P.N.	Cable Group	Finish	Insulation	Impedance	Crimp Tool
132128	05	Gold	Teflon	50	N/A

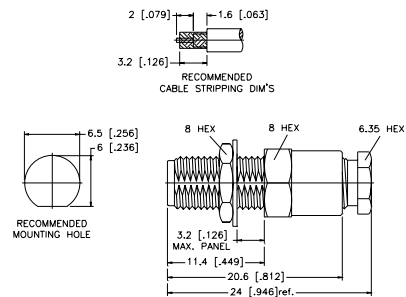
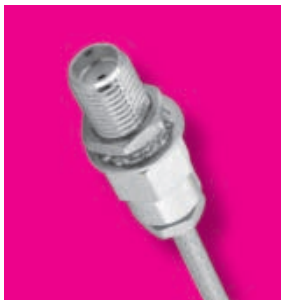

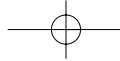

CLAMP TERMINATIONS FOR FLEXIBLE CABLE

For Cable Group Legend, see page 27

PANEL CLAMP JACK — MINIATURE CABLE

P.N.	Cable Group	Finish	Insulation	Impedance	Crimp Tool
132130	05	Gold	Teflon	50	N/A

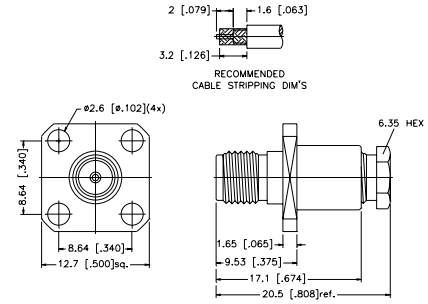

RIGHT ANGLE CLAMP PLUG — STANDARD CABLE

P.N.	Cable Group	Finish	Insulation	Impedance	Crimp Tool
132132	01	Gold	Teflon	50	N/A

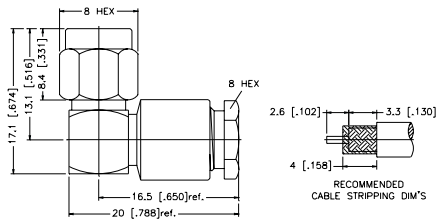
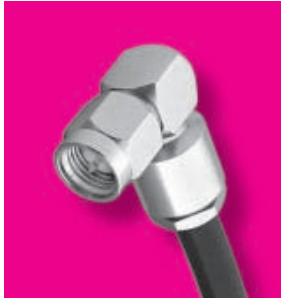

RIGHT ANGLE CLAMP PLUG — MINIATURE CABLE

P.N.	Cable Group	Finish	Insulation	Impedance	Crimp Tool
132131	05	Gold	Teflon	50	N/A

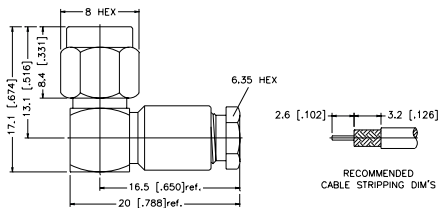
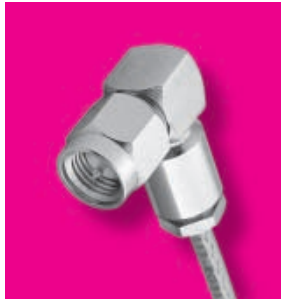

For Reverse Polarized connectors, add RP to standard part number. Contact Connex marketing for availability.
 For Reverse Threaded connectors, add RT to standard part number. Contact Connex marketing for availability.
 For Crimp Tool information, see page 183.

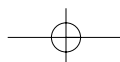

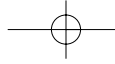

PRINTED CIRCUIT BOARD/STRAIGHT TERMINALS

For Cable Group Legend, see page 27

STRAIGHT PLUG FOR P.C. BOARD

P.N.	Cable Group	Finish	Insulation	Impedance	Crimp Tool
132133	N/A	Gold	Teflon	50	N/A

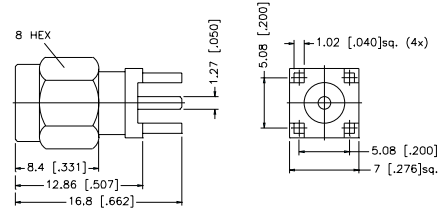

STRAIGHT JACK FOR P.C. BOARD

P.N.	Cable Group	Finish	Insulation	Impedance	Crimp Tool
132134	N/A	Gold	Teflon	50	N/A
132134-10	N/A	Gold	Teflon	50	N/A
	SURFACE MOUNT				
132319	N/A	Gold	Teflon	50	N/A
	EXTENDED BODY				
132320	N/A	Gold	Teflon	50	N/A
	2-HOLE PCB MOUNT				
132291	N/A	Gold	Teflon	50	N/A
	BULKHEAD MOUNT				

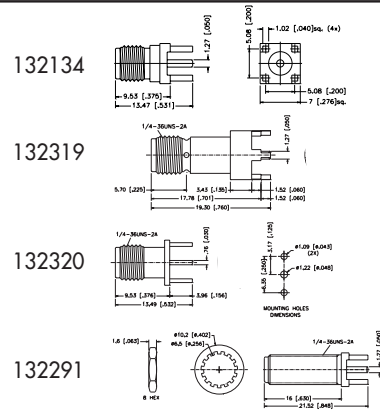

RIGHT ANGLE PLUG FOR P.C. BOARD

P.N.	Cable Group	Finish	Insulation	Impedance	Crimp Tool
132135	N/A	Gold	Teflon	50	N/A

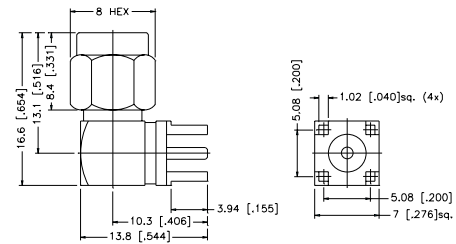

RIGHT ANGLE JACK FOR P.C. BOARD

P.N.	Cable Group	Finish	Insulation	Impedance	Crimp Tool
132136	N/A	Gold	Teflon	50	N/A
132225	N/A	Gold	Teflon	50	N/A
	DIECAST BODY				

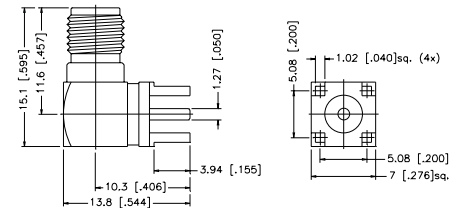

For Reverse Polarized connectors, add RP to standard part number. Contact Connex marketing for availability.
 For Reverse Threaded connectors, add RT to standard part number. Contact Connex marketing for availability.
 For Crimp Tool information, see page 183.

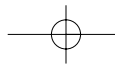

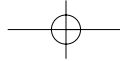

BULKHEAD MOUNT/SOLDER POT TERMINALS

For Cable Group Legend, see page 27

BULKHEAD JACK RECEPTACLE — FRONT MOUNT

P.N.	Cable Group	Finish	Insulation	Impedance	Crimp Tool
132137	N/A	Gold	Teflon	50	N/A



132137

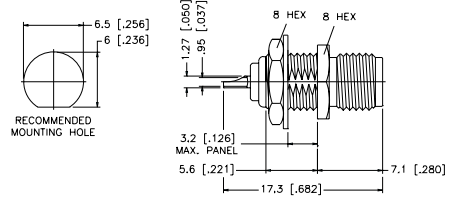

132271	N/A	Gold	Teflon	50	N/A
EXTENDED BODY, BLUNT POST					

132271

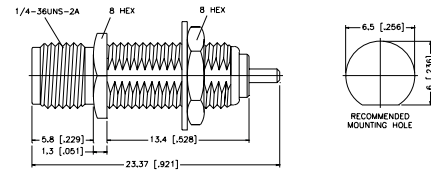

BULKHEAD JACK RECEPTACLE — REAR MOUNT

P.N.	Cable Group	Finish	Insulation	Impedance	Crimp Tool
132138	N/A	Gold	Teflon	50	N/A

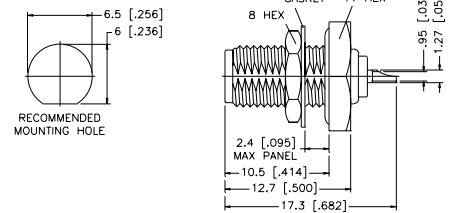

BULKHEAD JACK RECEPTACLE — REAR MOUNT

P.N.	Cable Group	Finish	Insulation	Impedance	Crimp Tool
132139	N/A	Gold	Teflon	50	N/A
132227	N/A	Gold	Teflon	50	N/A
FLATWASHER					

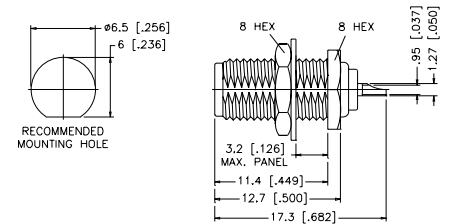

For Reverse Polarized connectors, add RP to standard part number. Contact Connex marketing for availability.
 For Reverse Threaded connectors, add RT to standard part number. Contact Connex marketing for availability.
 For Crimp Tool information, see page 183.

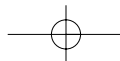

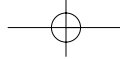

PANEL MOUNT/SOLDER POT TERMINALS

For Cable Group Legend, see page 27

PANEL MOUNT PLUG RECEPTACLE — 4-HOLE SQUARE FLANGE

P.N.	Cable Group	Finish	Insulation	Impedance	Crimp Tool
132140	N/A	Gold	Teflon	50	N/A

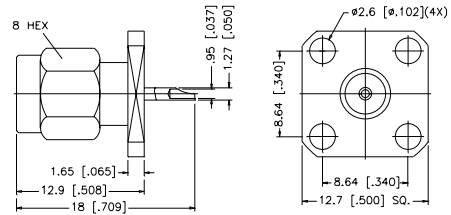

PANEL MOUNT PLUG RECEPTACLE — 2-HOLE FLANGE

P.N.	Cable Group	Finish	Insulation	Impedance	Crimp Tool
132141	N/A	Gold	Teflon	50	N/A

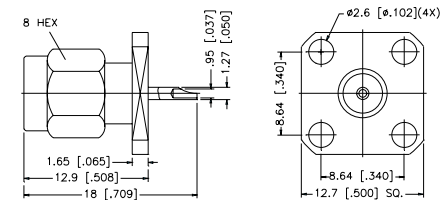

PANEL MOUNT JACK RECEPTACLE — 4-HOLE SQUARE FLANGE

P.N.	Cable Group	Finish	Insulation	Impedance	Crimp Tool
132142	N/A	Gold	Teflon	50	N/A
132215	N/A	Gold	Teflon	50	N/A
12.7 mm [.500"] MOUNTING HOLES					
132304	N/A	Gold	Teflon	50	N/A
18.2 mm [.718"] MOUNTING HOLES					

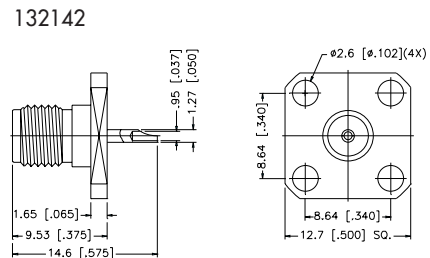

PANEL MOUNT JACK RECEPTACLE — 2-HOLE FLANGE

P.N.	Cable Group	Finish	Insulation	Impedance	Crimp Tool
132143	N/A	Gold	Teflon	50	N/A

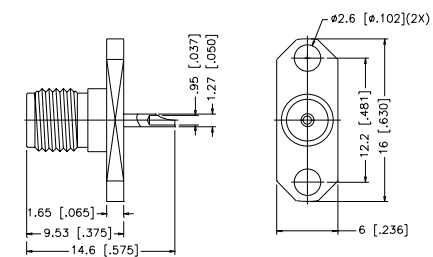

For Reverse Polarized connectors, add RP to standard part number. Contact Connex marketing for availability.
 For Reverse Threaded connectors, add RT to standard part number. Contact Connex marketing for availability.
 For Crimp Tool information, see page 183.

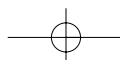

PANEL MOUNT/SOLDER POT TERMINALS

For Cable Group Legend, see page 27

RIGHT ANGLE PANEL MOUNT JACK RECEPTACLE — 4 HOLE SQUARE FLANGE

P.N.	Cable Group	Finish	Insulation	Impedance	Crimp Tool
132267	N/A	Gold	Teflon	50	N/A

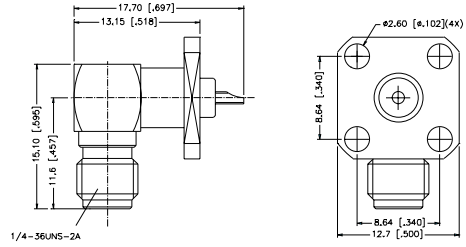

RIGHT ANGLE PANEL MOUNT JACK RECEPTACLE — 2-HOLE 90% FLANGE — EXPOSED TFE TYPE

P.N.	Cable Group	Finish	Insulation	Impedance	Crimp Tool
132275	N/A	Gold	Teflon	50	N/A

Remark: Extended teflon insulation available in various lengths. Contact Connex marketing department for part number and availability.

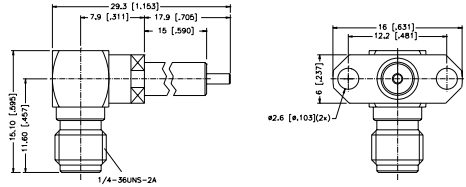

RIGHT ANGLE PANEL MOUNT JACK RECEPTACLE — 2-HOLE 45% FLANGE — EXPOSED TFE TYPE

P.N.	Cable Group	Finish	Insulation	Impedance	Crimp Tool
132276	N/A	Gold	Teflon	50	N/A
132288	N/A	Gold	Teflon	50	N/A

Remark: Extended teflon insulation available in various lengths. Contact Connex marketing department for part number and availability.

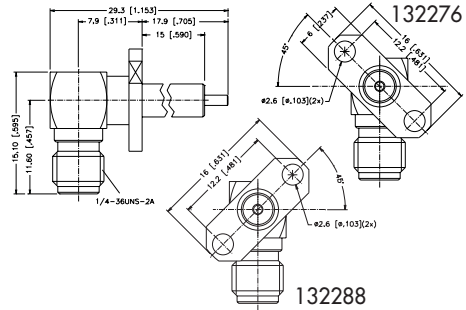

RIGHT ANGLE PANEL MOUNT RECEPTACLE — 4-HOLE FLANGE — EXPOSED TFE TYPE

P.N.	Cable Group	Finish	Insulation	Impedance	Crimp Tool
132318	N/A	Gold	Teflon	50	N/A

Remark: Extended teflon insulation available in various lengths. Contact Connex marketing department for part number and availability.

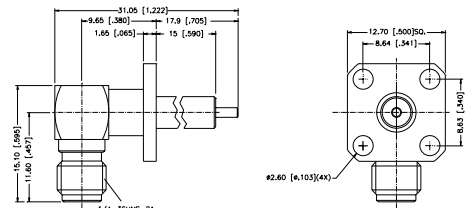

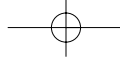

PANEL MOUNT/SOLDER POT TERMINALS

For Cable Group Legend, see page 27

PANEL MOUNT PLUG RECEPTACLE — 4-HOLE SQUARE FLANGE — EXPOSED TFE TYPE

P.N.	Cable Group	Finish	Insulation	Impedance	Crimp Tool
132144	N/A	Gold	Teflon	50	N/A
132300	N/A	Gold	Teflon	50	N/A
0.25 (.010") contact, 3.17 (.125") Teflon diameter					

Remark: Extended teflon insulation available in various lengths. Contact Connex marketing department for part number and availability.

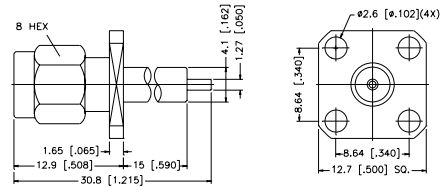

PANEL MOUNT PLUG RECEPTACLE — 2-HOLE FLANGE — EXPOSED TFE TYPE

P.N.	Cable Group	Finish	Insulation	Impedance	Crimp Tool
132145	N/A	Gold	Teflon	50	N/A
132301	N/A	Gold	Teflon	50	N/A
0.25 (.010") contact, 3.17 (.125") Teflon diameter					

Remark: Extended teflon insulation available in various lengths. Contact Connex marketing department for part number and availability.

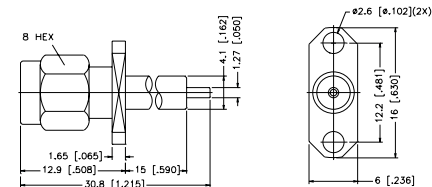

PANEL MOUNT JACK RECEPTACLE — 4-HOLE SQUARE FLANGE — EXPOSED TFE TYPE

P.N.	Cable Group	Finish	Insulation	Impedance	Crimp Tool
132146	N/A	Gold	Teflon	50	N/A
132302	N/A	Gold	Teflon	50	N/A
0.25 (.010") contact, 3.17 (.125") Teflon diameter					

Remark: Extended teflon insulation available in various lengths. Contact Connex marketing department for part number and availability.

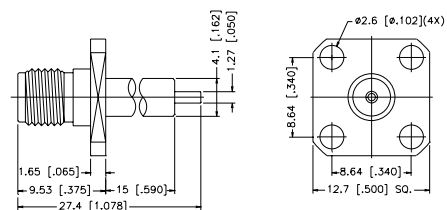

PANEL MOUNT JACK RECEPTACLE — 2-HOLE FLANGE — EXPOSED TFE TYPE

P.N.	Cable Group	Finish	Insulation	Impedance	Crimp Tool
132147	N/A	Gold	Teflon	50	N/A
132224	N/A	Gold	Teflon	50	N/A
0.25 (.010") contact, 3.17 (.125") Teflon diameter					

Remark: Extended teflon insulation available in various lengths. Contact Connex marketing department for part number and availability.

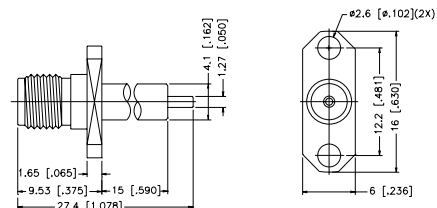

For Reverse Polarized connectors, add RP to standard part number. Contact Connex marketing for availability.
For Reverse Threaded connectors, add RT to standard part number. Contact Connex marketing for availability.
For Crimp Tool information, see page 183.

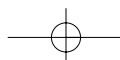

PANEL MOUNT/SOLDER POT TERMINALS

For Cable Group Legend, see page 27

PANEL MOUNT PLUG RECEPTACLE — 4 HOLE SQUARE FLANGE — BLUNT POST

P.N.	Cable Group	Finish	Insulation	Impedance	Crimp Tool
132148	N/A	Gold	Teflon	50	N/A

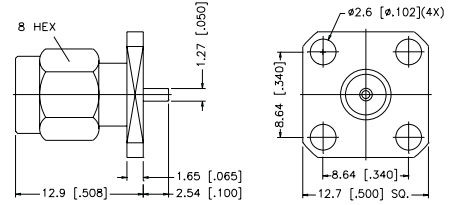

PANEL MOUNT PLUG RECEPTACLE — 2 HOLE FLANGE — BLUNT POST

P.N.	Cable Group	Finish	Insulation	Impedance	Crimp Tool
132149	N/A	Gold	Teflon	50	N/A

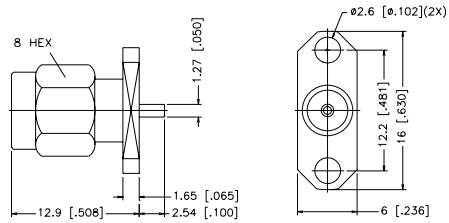

PANEL MOUNT JACK RECEPTACLE — 4 HOLE SQUARE FLANGE — BLUNT POST

P.N.	Cable Group	Finish	Insulation	Impedance	Crimp Tool
132150	N/A	Gold	Teflon	50	N/A
132204	N/A	Gold	Teflon	50	N/A
6.6 mm [.260"] POST					

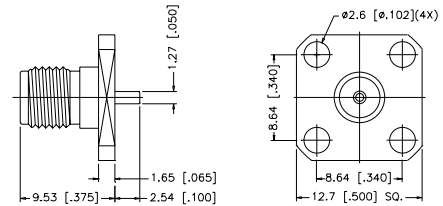

PANEL MOUNT JACK RECEPTACLE — 2 HOLE FLANGE — BLUNT POST

P.N.	Cable Group	Finish	Insulation	Impedance	Crimp Tool
132151	N/A	Gold	Teflon	50	N/A
132262	N/A	Gold	Teflon	50	N/A
8.37 mm [.330"] POST					

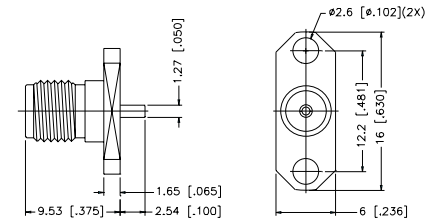

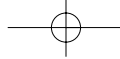

PANEL MOUNT/SOLDER POT TERMINALS

For Cable Group Legend, see page 27

PANEL MOUNT PLUG RECEPTACLE — 4-HOLE SQUARE FLANGE

P.N.	Cable Group	Finish	Insulation	Impedance	Crimp Tool
132152	N/A	Gold	Teflon	50	N/A

Remark: Size of slot width = 0.3 mm [.01"],
0.5 mm [.02"],
0.7 mm [.03"],

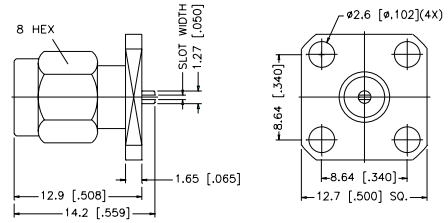

PANEL MOUNT PLUG RECEPTACLE — 2-HOLE FLANGE

P.N.	Cable Group	Finish	Insulation	Impedance	Crimp Tool
132153	N/A	Gold	Teflon	50	N/A

Remark: Size of slot width = 0.3 mm [.01"],
0.5 mm [.02"],
0.7 mm [.03"],

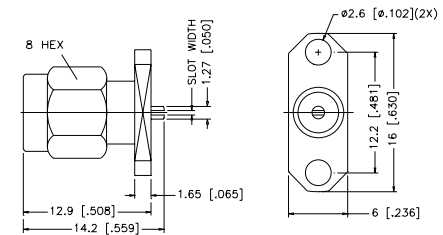

PANEL MOUNT JACK RECEPTACLE — 4-HOLE SQUARE FLANGE

P.N.	Cable Group	Finish	Insulation	Impedance	Crimp Tool
132154	N/A	Gold	Teflon	50	N/A
132214	N/A	Gold	Teflon	50	N/A

12.7 mm [.500"] MOUNTING HOLES
Remark: Size of slot width = 0.3 mm [.01"],
0.5 mm [.02"],
0.7 mm [.03"],

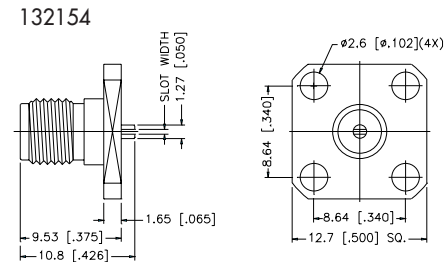

PANEL MOUNT JACK RECEPTACLE — 2-HOLE FLANGE

P.N.	Cable Group	Finish	Insulation	Impedance	Crimp Tool
132155	N/A	Gold	Teflon	50	N/A

Remark: Size of slot width = 0.3 mm [.01"],
0.5 mm [.02"],
0.7 mm [.03"],

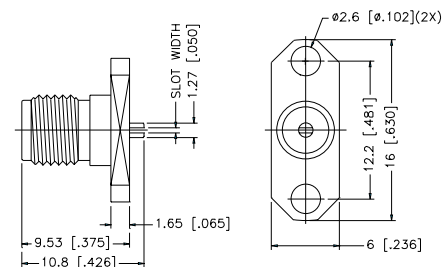

For Reverse Polarized connectors, add RP to standard part number. Contact Connex marketing for availability.
For Reverse Threaded connectors, add RT to standard part number. Contact Connex marketing for availability.
For Crimp Tool information, see page 183.

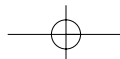

PANEL MOUNT/HALF ROUND POT TERMINALS

For Cable Group Legend, see page 27

PANEL MOUNT PLUG RECEPTACLE — 4 HOLE SQUARE FLANGE — HALF ROUND TERMINAL

P.N.	Cable Group	Finish	Insulation	Impedance	Crimp Tool
132156	N/A	Gold	Teflon	50	N/A

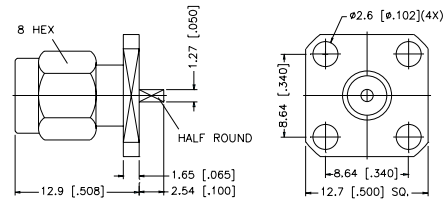

PANEL MOUNT PLUG RECEPTACLE — 2 HOLE FLANGE — HALF ROUND TERMINAL

P.N.	Cable Group	Finish	Insulation	Impedance	Crimp Tool
132157	N/A	Gold	Teflon	50	N/A

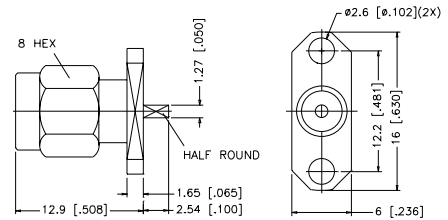

PANEL MOUNT JACK RECEPTACLE — 4 HOLE SQUARE FLANGE — HALF ROUND TERMINAL

P.N.	Cable Group	Finish	Insulation	Impedance	Crimp Tool
132158	N/A	Gold	Teflon	50	N/A

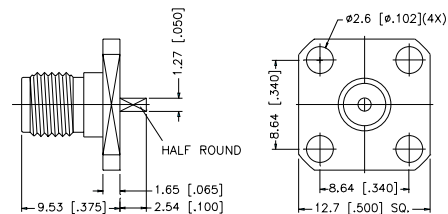

PANEL MOUNT JACK RECEPTACLE — 2 HOLE FLANGE — HALF ROUND TERMINAL

P.N.	Cable Group	Finish	Insulation	Impedance	Crimp Tool
132159	N/A	Gold	Teflon	50	N/A

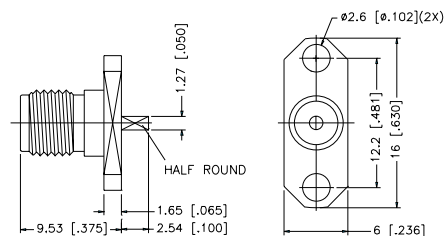

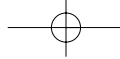

PANEL MOUNT/TERMINALS FLUSH TO BELOW FLANGE

For Cable Group Legend, see page 27

PANEL MOUNT PLUG RECEPTACLE — 4 HOLE SQ. FLANGE — TERMINAL FLUSH TO BELOW FLANGE

P.N.	Cable Group	Finish	Insulation	Impedance	Crimp Tool
132160	N/A	Gold	Teflon	50	N/A

Remark: Pin size of d = .305 mm [.012"],
.381 mm [.015"],
.457 mm [.018"]

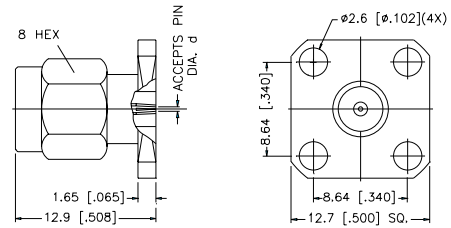

PANEL MOUNT PLUG RECEPTACLE — 2 HOLE FLANGE — TERMINAL FLUSH TO BELOW FLANGE

P.N.	Cable Group	Finish	Insulation	Impedance	Crimp Tool
132161	N/A	Gold	Teflon	50	N/A

Remark: Pin size of d = .305 mm [.012"],
.381 mm [.015"],
.457 mm [.018"]

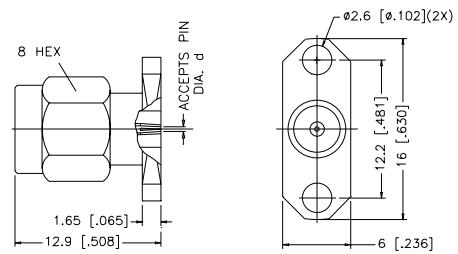

PANEL MOUNT JACK RECEPTACLE — 4 HOLE SQ. FLANGE — TERMINAL FLUSH TO BELOW FLANGE

P.N.	Cable Group	Finish	Insulation	Impedance	Crimp Tool
132162	N/A	Gold	Teflon	50	N/A

Remark: Pin size of d = .305 mm [.012"],
.381 mm [.015"],
.457 mm [.018"]

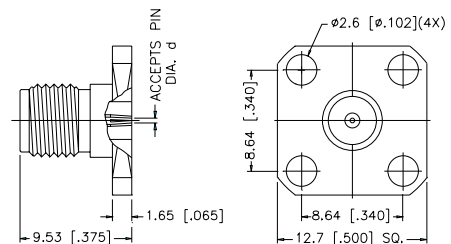

PANEL MOUNT JACK RECEPTACLE — 2 HOLE FLANGE — TERMINAL FLUSH TO BELOW FLANGE

P.N.	Cable Group	Finish	Insulation	Impedance	Crimp Tool
132163	N/A	Gold	Teflon	50	N/A

Remark: Pin size of d = .305 mm [.012"],
.381 mm [.015"],
.457 mm [.018"]

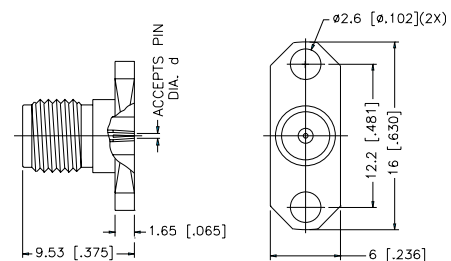

For Reverse Polarized connectors, add RP to standard part number. Contact Connex marketing for availability.
For Reverse Threaded connectors, add RT to standard part number. Contact Connex marketing for availability.
For Crimp Tool information, see page 183.

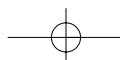
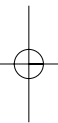
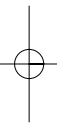

PANEL MOUNT/TAB TERMINALS

For Cable Group Legend, see page 27

PANEL MOUNT PLUG RECEPTACLE — 4 HOLE SQUARE FLANGE — TAB TERMINAL

P.N.	Cable Group	Finish	Insulation	Impedance	Crimp Tool
132164	N/A	Gold	Teflon	50	N/A

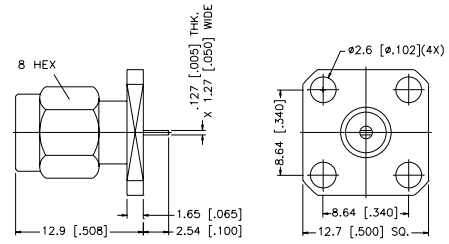

PANEL MOUNT PLUG RECEPTACLE — 2 HOLE FLANGE — TAB TERMINAL

P.N.	Cable Group	Finish	Insulation	Impedance	Crimp Tool
132165	N/A	Gold	Teflon	50	N/A

Remark: Specify horizontal or vertical tab when ordering

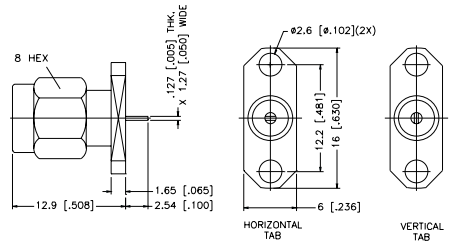

PANEL MOUNT JACK RECEPTACLE — 4 HOLE SQUARE FLANGE — TAB TERMINAL

P.N.	Cable Group	Finish	Insulation	Impedance	Crimp Tool
132166	N/A	Gold	Teflon	50	N/A

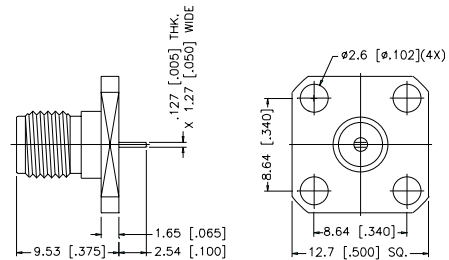

PANEL MOUNT JACK RECEPTACLE — 2 HOLE FLANGE — TAB TERMINAL

P.N.	Cable Group	Finish	Insulation	Impedance	Crimp Tool
132167	N/A	Gold	Teflon	50	N/A

Remark: Specify horizontal or vertical tab when ordering

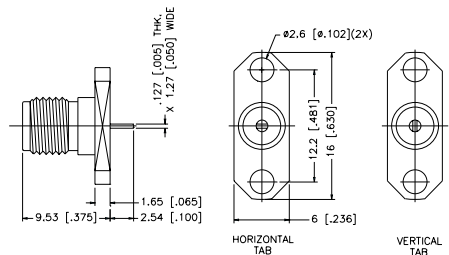

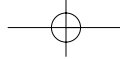

MINIATURE IN-SERIES ADAPTERS

For Cable Group Legend, see page 27

PLUG-TO-PLUG ADAPTER

P.N.	Cable Group	Finish	Insulation	Impedance	Crimp Tool
132168	N/A	Gold	Teflon	50	N/A
132168SS	N/A	S/S	Teflon	50	N/A
	STAINLESS STEEL BODY				

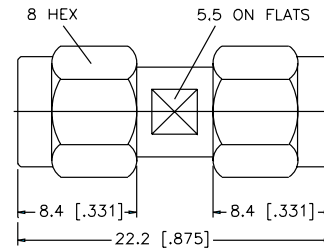
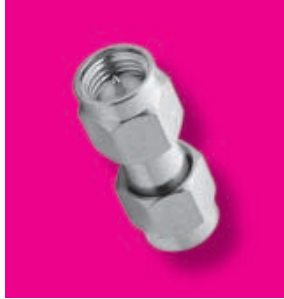

JACK-TO-JACK ADAPTER

P.N.	Cable Group	Finish	Insulation	Impedance	Crimp Tool
132169	N/A	Gold	Teflon	50	N/A
132169SS	N/A	S/S	Teflon	50	N/A
	STAINLESS STEEL BODY				

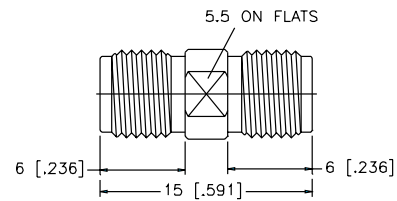

JACK-TO-JACK ADAPTER — BULKHEAD FEEDTHROUGH

P.N.	Cable Group	Finish	Insulation	Impedance	Crimp Tool
132170	N/A	Gold	Teflon	50	N/A
132170-11	N/A	Gold	Teflon	50	N/A
	O-RING SEAL				

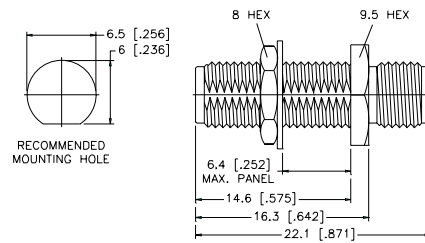

PLUG-TO-JACK ADAPTER

P.N.	Cable Group	Finish	Insulation	Impedance	Crimp Tool
132171	N/A	Gold	Teflon	50	N/A

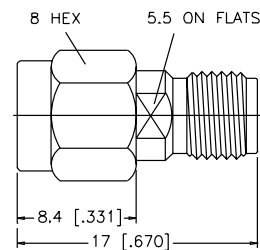

For Reverse Polarized connectors, add RP to standard part number. Contact Connex marketing for availability.
For Reverse Threaded connectors, add RT to standard part number. Contact Connex marketing for availability.
For Crimp Tool information, see page 183.

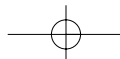

MINIATURE IN-SERIES ADAPTERS

For Cable Group Legend, see page 27

PLUG-TO-JACK ADAPTER — RIGHT ANGLE

P.N.	Cable Group	Finish	Insulation	Impedance	Crimp Tool
132172	N/A	Gold	Teflon	50	N/A

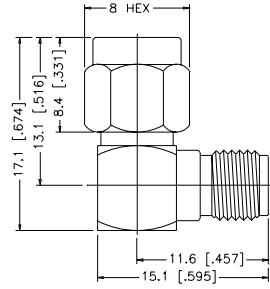
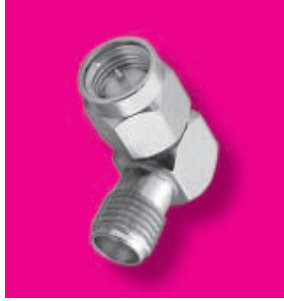

JACK-TO-JACK ADAPTER — RIGHT ANGLE

P.N.	Cable Group	Finish	Insulation	Impedance	Crimp Tool
132274	N/A	Gold	Teflon	50	N/A

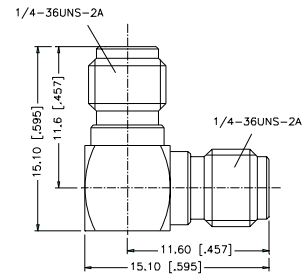
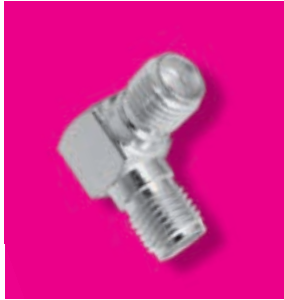

JACK-TO-JACK-TO-JACK TEE ADAPTER

P.N.	Cable Group	Finish	Insulation	Impedance	Crimp Tool
132216	N/A	Gold	Teflon	50	N/A

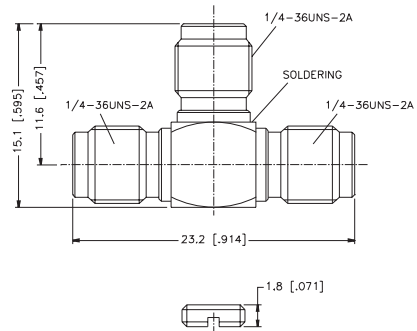
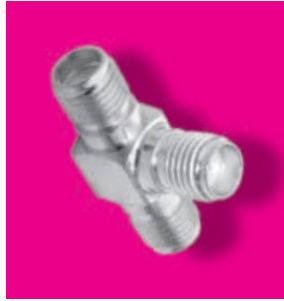

JACK-TO-PLUG-TO-JACK TEE ADAPTER

P.N.	Cable Group	Finish	Insulation	Impedance	Crimp Tool
132217	N/A	Gold	Teflon	50	N/A

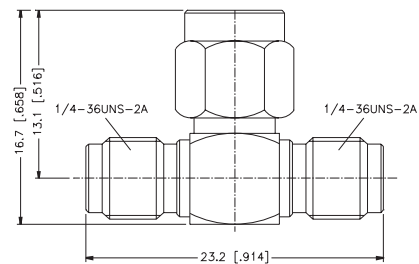

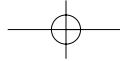

ACCESSORIES

For Cable Group Legend, see page 27

MALE CAP

P.N.	Cable Group	Finish	Insulation	Impedance	Crimp Tool
202112	N/A	Gold	Teflon	50	N/A
202112SS	N/A	S/S STAINLESS STEEL	Teflon	50	N/A
202112-10	N/A	Gold CAP & CHAIN	Teflon	50	N/A
132331	N/A	Gold SHORTING CAP	Teflon	50	N/A

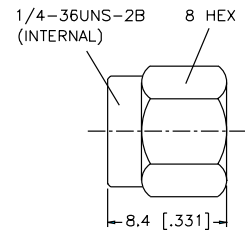

For Reverse Polarized connectors, add RP to standard part number. Contact Connex marketing for availability.
For Reverse Threaded connectors, add RT to standard part number. Contact Connex marketing for availability.
For Crimp Tool information, see page 183.

