

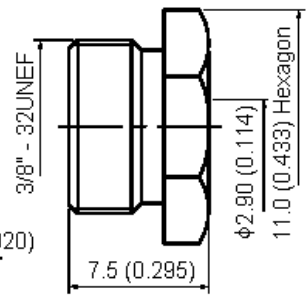

PART NO.  
13-04-19 TSS RG174U

REVISIONS						DRAWN	DATE	CHECKD	DATE	APPRVD	DATE
ECN #	REV	DESCRIPTION									
-	A	RELEASED				Kavitha	31/8/07	Suresh	31/8/07	G. C	17/9/07

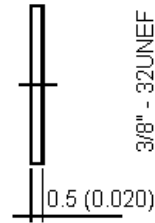
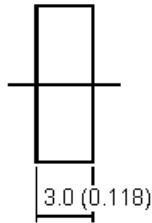
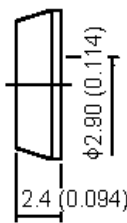
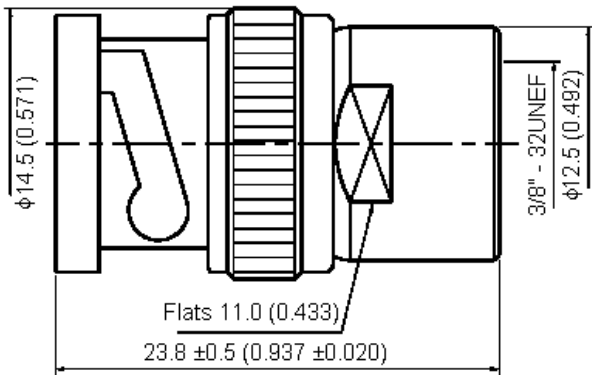

**Specifications:**

- Bodies : Brass per JIS-C3604.
- Centre Contact : Brass per JIS-C3604.
- Insulation : Teflon per ASTM D1457 and ASTM D1710.
- Connector interface per MIL-STD-348A.
- Part to be clean and free of burrs.

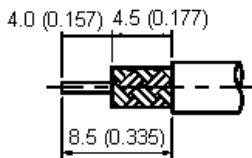

**Stripping Dimension**

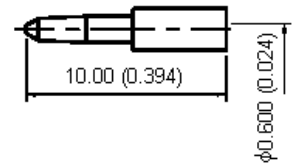
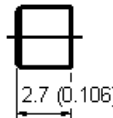

Dimensions : Millimetres (Inches)

This data sheet and its contents (the "Information") belong to the Premier Farnell Group (the "Group") or are licensed to it. No licence is granted for the use of it other than for information purposes in connection with the products to which it relates. No licence of any intellectual property rights is granted. The Information is subject to change without notice and replaces all data sheets previously supplied. The Information supplied is believed to be accurate but the Group assumes no responsibility for its accuracy or completeness, any error in or omission from it or for any use made of it. Users of this data sheet should check for themselves the Information and the suitability of the products for their purpose and not make any assumptions based on information included or omitted. Liability for loss or damage resulting from any reliance on the Information or use of it (including liability resulting from negligence or where the Group was aware of the possibility of such loss or damage arising) is excluded. This will not operate to limit or restrict the Group's liability for death or personal injury resulting from its negligence. SPC MULTICOMP is the registered trademark of the Group. © Premier Farnell plc 2007.

**TOLERANCES:**  
UNLESS OTHERWISE SPECIFIED, DIMENSIONS ARE FOR REFERENCE PURPOSES ONLY.

<b>DRAWN BY:</b>	<b>DATE:</b>
Kavitha	31/08/07
<b>CHECKED BY:</b>	<b>DATE:</b>
Suresh	31/08/07
<b>APPROVED BY:</b>	<b>DATE:</b>
G.Cook	17/09/07

<b>DRAWING TITLE:</b>			
13-04-19 TSS RG174U			
<b>SIZE</b>	<b>DWG NO.</b>	<b>ELECTRONIC FILE</b>	<b>REV</b>
A	M10000449	1169574_DWG	A
<b>SCALE:</b> NTS		<b>U.O.M.:</b> mm (Inches)	<b>SHEET:</b> 1 OF 2



PART NO.

13-04-19 TSS RG174U

REVISIONS

ECN #	REV	DESCRIPTION	DRAWN	DATE	CHECKED	DATE	APPRVD	DATE
-	A	RELEASED	Kavitha	31/8/07	Suresh	31/8/07	G. C	17/9/07

Specification Table

Number	Description	Material	Finish	Part Number
1	Shell	Brass	Silver 70µ" Minimum	13-04-19 TSS RG174U
2	Body			
3	Insulation	Teflon	None	
4	Gasket	Silicone	Red	
5	Washer	Brass	Nickel 100µ" Minimum	
6	Insulation	Teflon	None	
7	Spring Washer	SK-5	Nickel 100µ" Minimum	
8	Washer	Brass	Silver 70µ" Minimum	
9	Braid Clamp			
10	Gasket	Silicone	Red	
11	Washer	Brass	Silver 70µ" Minimum	
12	Nut			
13	Centre Contact			

<http://www.farnell.com>  
<http://www.newark.com>  
<http://www.cpc.co.uk>

This data sheet and its contents (the "Information") belong to the Premier Farnell Group (the "Group") or are licensed to it. No licence is granted for the use of it other than for information purposes in connection with the products to which it relates. No licence of any intellectual property rights is granted. The Information is subject to change without notice and replaces all data sheets previously supplied. The Information supplied is believed to be accurate but the Group assumes no responsibility for its accuracy or completeness, any error in or omission from it or for any use made of it. Users of this data sheet should check for themselves the Information and the suitability of the products for their purpose and not make any assumptions based on information included or omitted. Liability for loss or damage resulting from any reliance on the Information or use of it (including liability resulting from negligence or where the Group was aware of the possibility of such loss or damage arising) is excluded. This will not operate to limit or restrict the Group's liability for death or personal injury resulting from its negligence. SPC MULTICOMP is the registered trademark of the Group. © Premier Farnell plc 2007.

**TOLERANCES:**  
UNLESS OTHERWISE SPECIFIED, DIMENSIONS ARE FOR REFERENCE PURPOSES ONLY.

<b>DRAWN BY:</b>	<b>DATE:</b>
Kavitha	31/08/07
<b>CHECKED BY:</b>	<b>DATE:</b>
Suresh	31/08/07
<b>APPROVED BY:</b>	<b>DATE:</b>
G.Cook	17/09/07

<b>DRAWING TITLE:</b>			
13-04-19 TSS RG174U			
<b>SIZE</b>	<b>DWG NO.</b>	<b>ELECTRONIC FILE</b>	<b>REV</b>
A	M10000449	1169574_DWG	A
<b>SCALE: NTS</b>		<b>U.O.M.: mm (Inches)</b>	<b>SHEET: 2 OF 2</b>