

PE16/32_sv Series

Mains Plugs

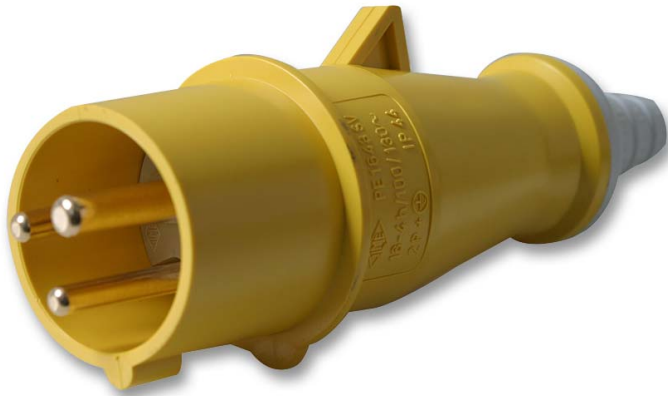



PRO-POWER
Quality Cables

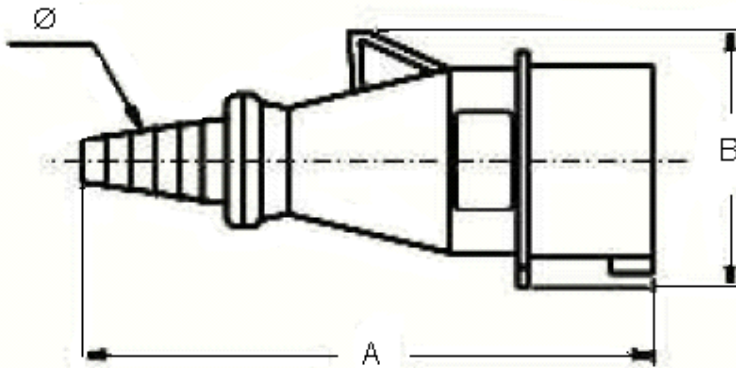

Features:

- In compliance with EN 60309-1 and EN 60309-2 standards.
- Enclosure, insert and locking ring in insulating, thermoplastic, self-extinguishing material.
- Cable anchoring collar incorporated in the insert.
- Entry with grommet, enclosure colour coded according to the operating voltage.



Current Rating (A)	Poles	A	B	Ø Minimum	Ø Maximum
16	2P + 	143.5	59	7	17
	3P + 	148.5	66		
	3P + N + 	167.5	75	9	22
32	2P + 	187	80		
	3P + 		192.5		

Dimensions : Millimetres

PRO-POWER
Quality Cables

PE16/32_sv Series

Mains Plugs

PRO-POWER
Quality Cables

Part Number Table

Description	Part Number
Plug 16A IP44 110V	PE1643SVA
Plug 16A IP44 240V	PE1663SVA
Plug 16A IP44 415V	PE1664SVA
	PE1665SVA
Plug 32A IP44 110V	PE3243SVB
Plug 32A IP44 240V	PE3263SVB
Plug 32A IP44 415V	PE3264SVB
	PE3265SVB

PRO-POWER
Quality Cables

PE16/32_sv Series

Mains Plugs

PRO-POWER
Quality Cables

Notes:

International Sales Offices:



AUSTRALIA – Farnell InOne
Tel No: ++ 61 2 9645 8888
Fax No: ++ 61 2 9644 7898



FINLAND – Farnell InOne
Tel No: ++ 358 9 560 7780
Fax No: ++ 358 9 345 5411



NETHERLANDS – Farnell InOne
Tel No: ++ 31 30 241 7373
Fax No: ++ 31 30 241 7333



SWITZERLAND – Farnell InOne
Tel No: ++ 41 1 204 64 64
Fax No: ++ 41 1 204 64 54



AUSTRIA – Farnell InOne
Tel No: ++ 32 3 475 2810
Fax No: ++ 43 662 2180 670



FRANCE – Farnell InOne
Tel No: ++ 49 89 61 39 39 99
Fax No: ++ 33 474 68 99 90



NEW ZEALAND – Farnell InOne
Tel No: ++ 64 9 357 0646
Fax No: ++ 64 9 357 0656



UK – Farnell InOne
Tel No: ++ 44 8701 200 200
Fax No: ++ 44 8701 200 201



BELGIUM – Farnell InOne
Tel No: ++ 32 3 475 2810
Fax No: ++ 32 3 227 3648



GERMANY – Farnell InOne
Tel No: ++ 49 89 61 39 39 99
Fax No: ++ 49 89 613 59 01



NORWAY – Farnell InOne
Tel No: ++ 45 44 53 66 66
Fax No: ++ 45 44 53 66 02



UK – BuckHickman InOne
++ 44 8450 510 150
++ 44 8450 510 130



BRAZIL – Farnell-Newark InOne
Tel No: ++ 55 11 4066 9400
Fax No: ++ 55 11 4066 9410



HONG KONG – Farnell-Newark InOne
Tel No: ++ 852 2268 9888
Fax No: ++ 852 2268 9899



PORTUGAL – Farnell InOne
Tel No: ++ 34 93 475 8804
Fax No: ++ 34 93 474 5288



UK – CPC
++ 44 8701 202 530
++ 44 8701 202 531



CHINA – Farnell-Newark InOne
Tel No: ++86 10 6238 5152
Fax No: ++86 10 6238 5022



IRELAND – Farnell InOne
Tel No: ++ 353 1 830 9277
Fax No: ++ 353 1 830 9016



SINGAPORE – Farnell-Newark InOne
Tel No: ++ 65 6788 0200
Fax No: ++ 65 6788 0300



EXPORT – Farnell InOne
Tel No: ++ 44 8701 200 208
Fax No: ++ 44 8701 200 209

For enquiries from all other markets



DENMARK – Farnell InOne
Tel No: ++ 45 44 53 66 44
Fax No: ++ 45 44 53 66 06



ITALY – Farnell InOne
Tel No: ++ 39 02 93 995 200
Fax No: ++ 39 02 93 995 300



SPAIN – Farnell InOne
Tel No: ++ 34 93 475 8805
Fax No: ++ 34 93 474 5107



ESTONIA – Farnell InOne
Tel No: ++ 358 9 560 7780
Fax No: ++ 358 9 345 5411



MALAYSIA – Farnell-Newark InOne
Tel No: ++ 60 3 7873 8000
Fax No: ++ 60 3 7873 7000



SWEDEN – Farnell InOne
Tel No: ++ 46 8 730 50 00
Fax No: ++ 46 8 83 52 62

<http://www.farnellinone.com>

<http://www.buckhickmaninone.com>

<http://www.cpc.co.uk>

Disclaimer This data sheet and its contents (the "Information") belong to the Premier Farnell Group (the "Group") or are licensed to it. No licence is granted for the use of it other than for information purposes in connection with the products to which it relates. No licence of any intellectual property rights is granted. The Information is subject to change without notice and replaces all data sheets previously supplied. The Information supplied is believed to be accurate but the Group assumes no responsibility for its accuracy or completeness, any error in or omission from it or for any use made of it. Users of this data sheet should check for themselves the Information and the suitability of the products for their purpose and not make any assumptions based on information included or omitted. Liability for loss or damage resulting from any reliance on the Information or use of it (including liability resulting from negligence or where the Group was aware of the possibility of such loss or damage arising) is excluded. This will not operate to limit or restrict the Group's liability for death or personal injury resulting from its negligence. Pro-Power is the registered trademark of the Group. © Premier Farnell plc 2004.

PRO-POWER
Quality Cables