

13 12 11 10 9 8 7 6 1396 4 3 2 1

PLUG

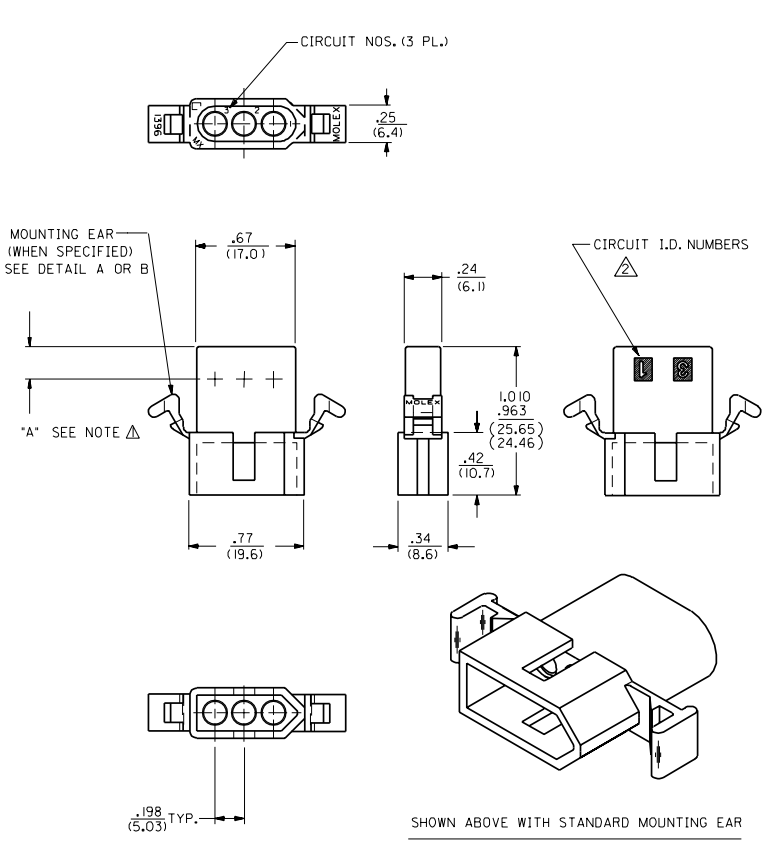

RECEPTACLE

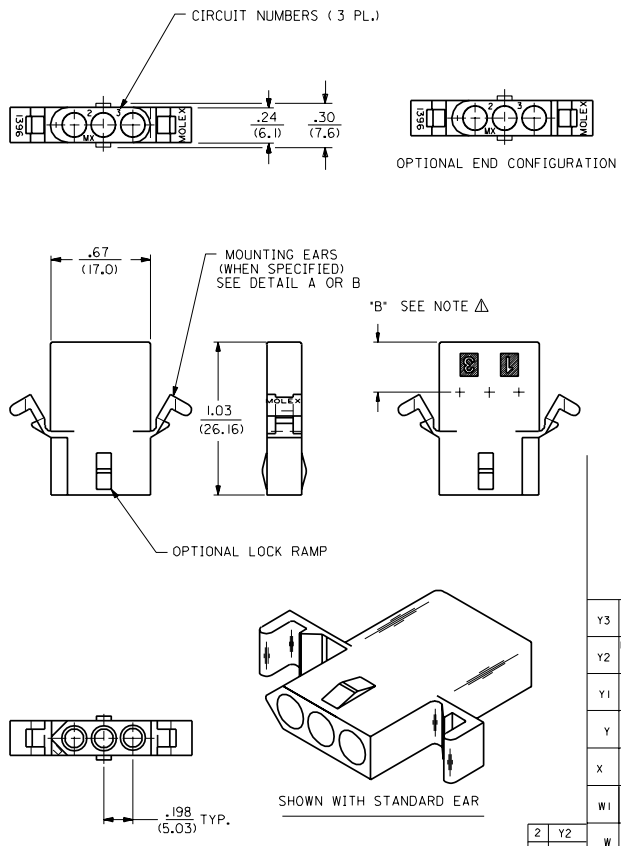

NOTES:
 Δ DIMENSION FROM THE BACK OF HOUSING TO THE END OF THE BRUSH ON THE WIRE INSERTED INTO THE HOUSING
 DIM "A" = .256/6.50 FOR 42477 & 42478 TERMINALS
 .216/5.49 FOR ALL OTHER .093 TERMINALS
 DIM "B" = .377/9.58 FOR 42477 & 42478 TERMINALS
 .337/8.56 FOR ALL OTHER .093 TERMINALS

Y3	REVISED PER UCR2000-0683 3/1/00 DUS
Y2	REMOVE -R3, -R5 VER. PER ECR #108 1479 6-10-96 RW
Y1	X-REMOVE 1396-R4 ECR U3 1583 C/C 10/26/93 RW
Y	ADD CKT. I.D. #'S PER ECR U3 0683 C/C 5/4/93 RW
X	REV. MNT'L SPECS. ECR U2-1491 10-08-92 A.GUZLIK
W1	ADD -D VERSIONS. ECR U1 106 C/C 7/25/91 RW
2	Y2 W REVISE ON CAD ECR #108 1381
1	Y3 W JUS 4-24-88 RW

DIMENSIONS SHOWN METRIC INCH

3 PLACE	± .010	---
2 PLACE	± .014	± 0.25
1 PLACE	---	± 0.35

DRAFT WHERE APPLICABLE MUST REMAIN WITHIN DIMENSIONS

DRG. NO. 60552

FILE NAME 51396.3X1.DWG

SCALE 2:1

DATE 4/3/88

REV. 1 OF 2

SD-1396-*

CP C

13 12 11 10 9 8 7 6 5 4 3 2 1

DWG. NO. SD-1396-001

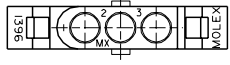
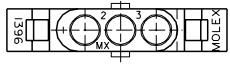

OPTIONAL END CONFIGURATION

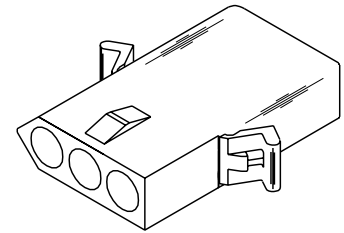
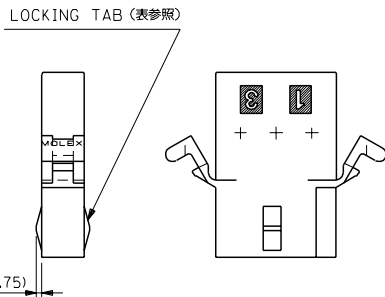
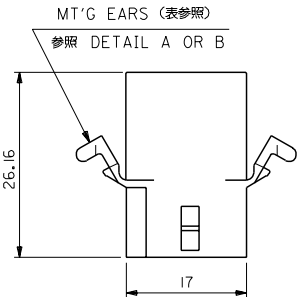

RECEPTACLE

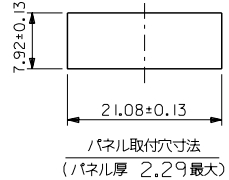
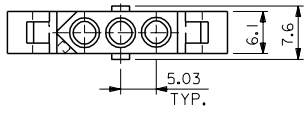
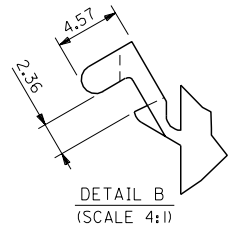
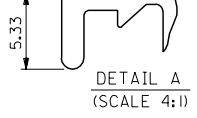

1396R4	03-09-1081	有 WITH	有 WITH DETAIL B
1396R2	03-09-1033	無 WITHOUT	無 WITHOUT
1396R1	03-09-1032	有 WITH	無 WITHOUT
1396R	03-09-1031	有 WITH	有 WITH DETAIL A
ENG. NO.	EDP NO.	LOCKING TABS	MT'G EARS

MODEL NO.	03-09-1***	DIMENSIONS:	SHT	REV
DESIGN UNITS	<input checked="" type="checkbox"/> mm <input type="checkbox"/> INCH	THIRD ANGLE PROJECTION	<input type="checkbox"/> mm ONLY	REVISE ON CAD ONLY

DO NOT SCALE DRAWING		EC NO. / DRWN: / CHK: / APPR:		EC NO. / DRWN: / CHK: / APPR:		EC NO. / DRWN: / CHK: / APPR:		EC NO. / DRWN: / CHK: / APPR:		EC NO. / DRWN: / CHK: / APPR:		RELEASED 0078 JC2001-00008 DRWN: K.KOHAMA CHK: T.YAMAGUCHI APPR: M.FUKUSHIMA		MATERIAL 材料 NYLON66 94V-2		GENERAL TOLERANCES: (UNLESS SPECIFIED) 一般公差		SCALE 2:1		DESIGN UNITS <input checked="" type="checkbox"/> mm <input type="checkbox"/> INCH		THIRD ANGLE PROJECTION		TITLE: 3 CIRCUITS RCPT HSG (0.093 DIA TERMINAL)		SHEET NO. 1 OF 1					
		EC NO. / DRWN: / CHK: / APPR:		EC NO. / DRWN: / CHK: / APPR:		EC NO. / DRWN: / CHK: / APPR:		EC NO. / DRWN: / CHK: / APPR:		EC NO. / DRWN: / CHK: / APPR:		FINISH 仕上げ		WIRE RANGE 適用電線範囲		ANGLE 角度 ±3°		DRAWN BY & DATE K.KOHAMA 00/08/28		CHECKED BY & DATE T.YAMAGUCHI 00/08/28		APPROVED BY & DATE M.FUKUSHIMA 00/08/28		CAD FILENAME 1396001.S01		MATERIAL NO. SEE NOTES		DRAWING NO. SD-1396-001		SIZE B	
																				THIS DRAWING CONTAINS INFORMATION THAT IS PROPRIETARY TO MOLEX INCORPORATED AND SHOULD NOT BE USED WITHOUT WRITTEN PERMISSION.		EN-02J(097) MXJ-54									