

Technical Characteristics



Number of contacts 6, 9, 10, 14, 15, 16, 20, 24, 25, 26, 28
34, 37, 40, 50, 60, 64
Series SEK 18
UL/CSA-approved

Pitch

Male header 2.54 mm
Insulation displacement contacts on the flat cable connector 1.27 mm

Working current

1 A

Test voltage $U_{r.m.s.}$

1 kV
SEK 17, SEK 19 : 500 V

Contact resistance

$\leq 20 \text{ m}\Omega$

Insulation resistance

$\geq 10^9 \Omega$

Temperature range

-55 °C ... + 125 °C
-55 °C ... + 240 °C (high temperature version)
-55 °C ... + 105 °C (press-in version)

The maximum temperature includes heating of contacts and ambient temperature.

Terminations

SEK 18 female connector Insulation displacement connection
Wire AWG 28 (7 x 0.127) 0.09 mm²

SEK 18/19 male header Wrap posts 0.6 x 0.6 mm
Diagonal 0.79 - 0.86 mm
Solder pins for P.C.B. hole \varnothing 0.9 mm,
DIN IEC 52 141

Compliant press-in termination for \varnothing 0.94 - 1.06 mm

SEK 17 DIP connector and SEK 18/19 transition connectors Insulation displacement connection
Wire AWG 28 (7 x 0.127) 0.09 mm²

Solder pins 0.45 x 0.35 mm for P.C.B. hole 0.8 mm

Gds A-B · Gds A-C D-Sub Insulation displacement connection
Wire AWG 28 (7 x 0.127) 0.09 mm²

Mouldings

Thermoplastic resin (PBTP)
UL 94-V O
PCT UL 94-V O (high temperature version)

Contact surface

SEK 18/19 female and male connectors Contact zone: gold-plated according to Performance Level¹⁾
Termination zone: tinned

SEK 17 DIP connector and SEK 18/19 transition connector Tinned

Gds A-B · Gds A-C D-Sub Contact zone: gold-plated according to Performance Level¹⁾
Termination zone: tinned

¹⁾ Performance Level 3 as per DIN 41 651, Part 2
50 mating cycles · No gas test

¹⁾ Performance Level 2 as per DIN 41 651, Part 2
200 mating cycles · 4 days gas test

¹⁾ Performance Level as per MIL-C 83 503
> 0.76 μm Au (30 μinch) on request

Different contact surfaces on request

SEK 18

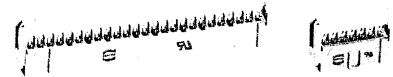

SEK 18/19

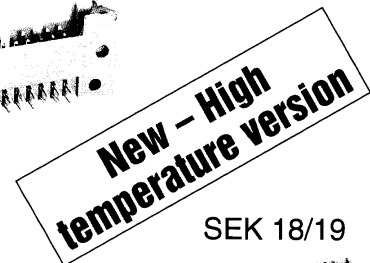
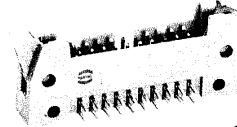

SEK 18/19



SEK 18

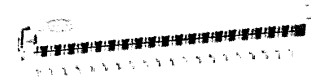

SEK 17



SEK 19



Gds A-B

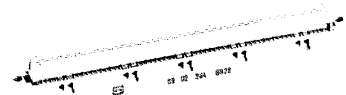

Gds A-C

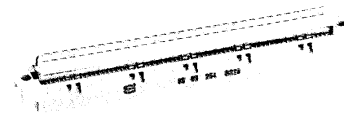

D-Sub

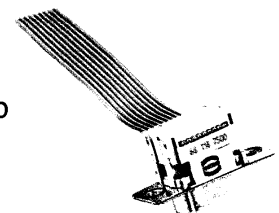

SEK 18



Number of contacts

6-64

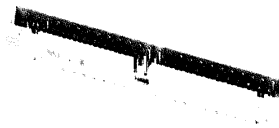

Low-profile male header, straight solder pins

Identification/pins	No. of contacts	Part No.	Drawing	Dimensions in mm		
				No. of contacts	A	B
Male header with straight solder pins Length: 2.9 mm	6	09 18 506 □ 324	6	15.2	12.78	2.54 x 2 = 5.08
	10	09 18 510 □ 324	10	20.3	17.86	2.54 x 4 = 10.16
	14	09 18 514 □ 324	14	25.4	22.94	2.54 x 6 = 15.24
	16	09 18 516 □ 324	16	27.9	25.48	2.54 x 7 = 17.78
	20	09 18 520 □ 324	20	33.0	30.56	2.54 x 9 = 22.86
	26	09 18 526 □ 324	26	40.6	38.18	2.54 x 12 = 30.48
	34	09 18 534 □ 324	34	50.8	48.34	2.54 x 16 = 40.64
	40	09 18 540 □ 324	40	58.4	55.96	2.54 x 19 = 48.26
	50	09 18 550 □ 324	50	71.3	68.66	2.54 x 24 = 60.96
	60	09 18 560 □ 324	60	84.0	81.36	2.54 x 29 = 73.66
	64	09 18 564 □ 324	64	89.1	86.44	2.54 x 31 = 78.74

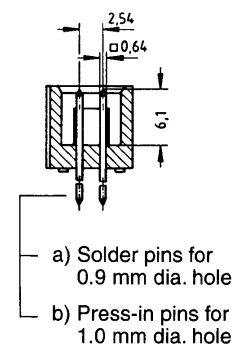

Male header with straight solder pins
Length: 2.9 mm
High temperature version

New

This version is compatible with surface mount assembly. They can withstand vapour phase and infra red reflow soldering temperatures.

Male header with straight solder pins
Length: 4.5 mm

6	09 19 506 □ 324*
10	09 19 510 □ 324*
14	09 19 514 □ 324*
16	09 19 516 □ 324*
20	09 19 520 □ 324*
26	09 19 526 □ 324*
34	09 19 534 □ 324*
40	09 19 540 □ 324*
50	09 19 550 □ 324*
60	09 19 560 □ 324*
64	09 19 564 □ 324*

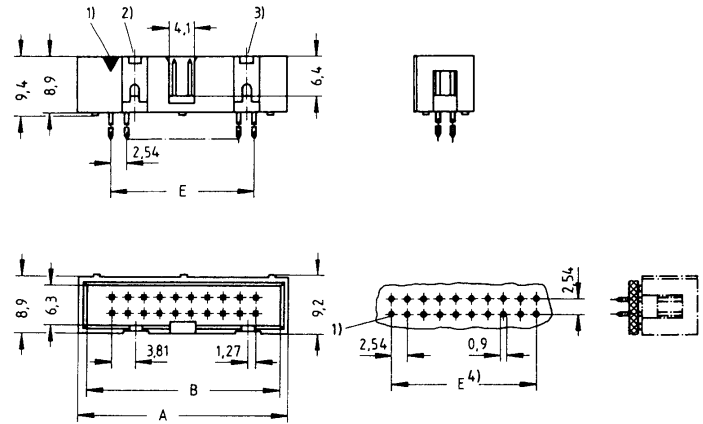

6	09 18 506 □ 322*
10	09 18 510 □ 322*
14	09 18 514 □ 322*
16	09 18 516 □ 322*
20	09 18 520 □ 322*
26	09 18 526 □ 322*
34	09 18 534 □ 322*
40	09 18 540 □ 322*
50	09 18 550 □ 322*
60	09 18 560 □ 322*
64	09 18 564 □ 322*

- 1) Contact number 1
- 2) No polarization slot for 6, 10 or 14 way male header
- 3) No polarization slot for 6 way male header
- 4) Pitch tolerance: ± 0.1

For Performance Level 3 please specify digit
 For Performance Level 2 please specify digit
 > 0.76 µm Au (30 µinch) on request *

* Not normally kept in stock

For accessories see page 19