



Table of Contents

DIP Sockets	
Solder Tail Dual Leaf (DL) Contact	5002-5007
Four-Fingered Contact (500 Series, 700 Series, 800 Series)	5008-5014
Surface Mount (800 SM Series)	5014, 5015
DIP Insertion and Withdrawal Tools (TI/TW Series, TX Series)	5016, 5017
SIP Sockets	
Solder Tail Dual Leaf (DL) Contact.....	5018, 5019
Terminal Strips, Four-Fingered Contact (500 Series).....	5020
SIMM Sockets	
SIMM MICRO-EDGE Sockets	5021-5023
SIMM II Right-Angle Sockets	5024, 5025
DIMM Sockets	
SO DIMM Sockets.....	5026, 5027
DIMM II Sockets	5028-5031
DIMM IIP (Performance) Sockets	5032
PLCC Sockets	
Surface Mount.....	5033-5035
Thru-Hole (PCS Series)	5036, 5037
Thru-Hole Economy	5038
PQFP Sockets	
Standard	5039, 5040
Metric	5041, 5042
Discrete Sockets	
HOLTITE Series Press-fit Sockets, Zero Profile	5043-5047
Adapters	
Plug Adapter Assemblies (600 Series)	5048-5050
Transistor Adapter Plugs (600-AG Series)	5051, 5052
Display Sockets	
Numerical Display Sockets (500 Series)	5053
Angle Mount DIP Sockets (500 Series)	5054
Ganged DIP Sockets (500 Series).....	5055
Specialty Sockets	
Crystal Socket Assemblies (800-AG & 8004-1G Series).....	5056-5060
Programming Jumper Plug Assemblies (8136-875 Series, 8136-475 Series)	5061, 5062
Fuse Sockets (500 Series)	5063
Crystal Oscillator Sockets (500 Series)	5064
Transistor & IC Low Profile Sockets (8059 Series)	5065, 5066
Transistor Sockets (8058 & 8060 Series)	5067-5070
Lamp Sockets (8060 Series)	5071, 5072
TO-3 Transistor Sockets (8080-1G Series)	5073, 5074
Push Fit Test Jacks (8000 Series)	5075, 5076
Printed Circuit Test Jacks (8041 Series, 8041 Series Commercial)	5077, 5078
Micro-Miniature Test Jacks (8046 Series Commercial)	5079, 5080



Solder Tail Dual Leaf (DL) Contact

Product Facts

- Dual wiping contacts
- Face wipe contacts for high reliability and constant, low resistance
- Anti-overstress prevents contact damage
- Large target area with tapered lead-in ramps for easy DIP insertion
- Stackable end-to-end and side-to-side (brickwalling) for high board density
- Housing standoffs and slots facilitate board cleaning
- Family of 6 through 48 positions
- Retention-style tails or straight solder tails
- Visual polarization
- Designed for automatic machine insertion — DIP-to-socket or socket-to-board (tube loaded)
- Recognized under the Component Program of Underwriters Laboratories Inc., 
- Certified by Canadian Standards Association 

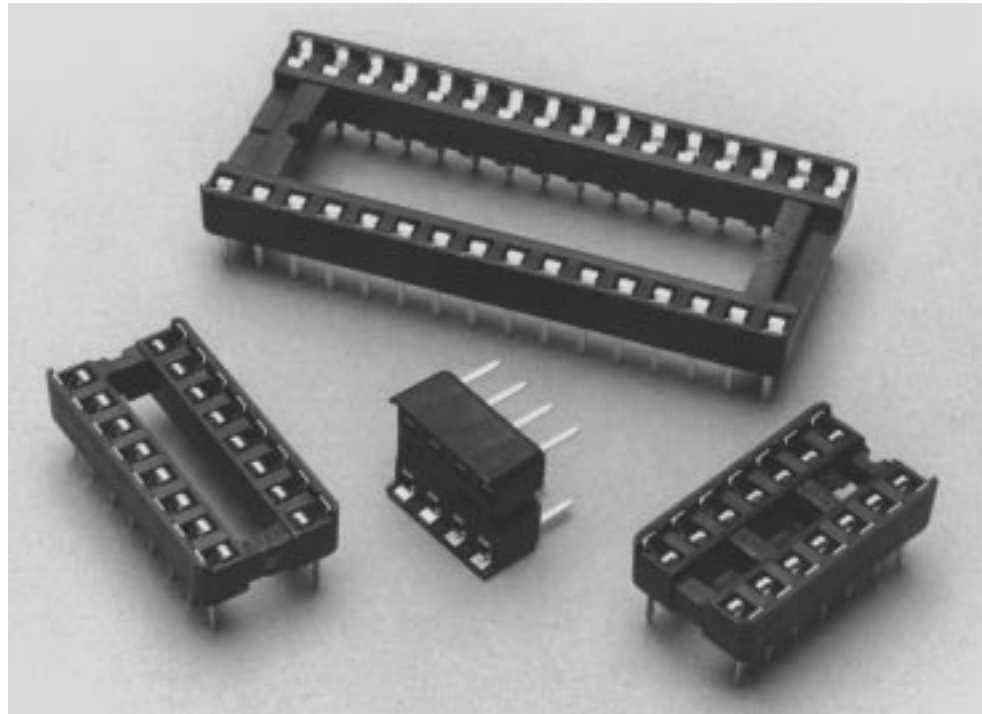

The Dual Leaf (DL) DIP socket family provides high quality at low cost with superior handling characteristics. Sockets are available in 6- through 48-position sizes with dual wiping contacts. The large target area of the contacts and tapered side ramps in the housing promote easy entry of a DIP package. Internal anti-overstress walls on standard versions prevent contact damage. The housings are compatible with commercially available automatic insertion equipment for socket-to-board or DIP-to-socket applications.

Standoffs provide board clearance for proper cleaning after soldering. Sockets are available with straight solder tails for clinching and are "true positioned" for automatic insertion into the pc board.

Performance Characteristics:

- Rating** — Signal application only
- Contact Resistance** — 20 milliohms max. (initial)
30 milliohms max. (after test)
- Dielectric Withstanding Voltage** — 1000 VRMS min.
- Insulation Resistance** — 10,000 megohms min. (initial)
- Capacitance** — 0.5 picofarad max.
- Operating Temperature** —
-40°C to +105°C (tin)
-55°C to +125°C (gold)
- Vibration** — 15 Gs, 10-2000 Hz with 100 ma current
- Shock** — 100 Gs sawtooth, 6 shocks
- Engaging Force** — 340 grams max. (initial)
- Separating Force** — 25 grams min. per Tyco Electronics Specification 108-1066 (Standard)

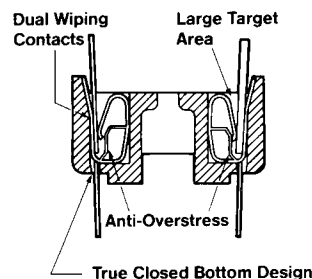

Dual Leaf (DL)

Sockets accept .008—.014
[0.2—0.36] thick IC leads

Material and Finish:

Housing — Glass-filled thermo-plastic, 94V-0 rated, black

Contacts — Phosphor bronze or beryllium copper with tin or gold plating (see table)

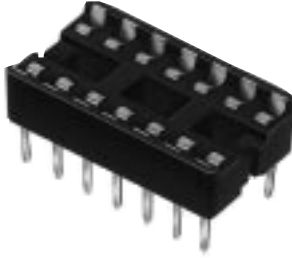

Note: All socket positions have "True Closed Bottom" design which allows no solder or flux wicking at class 1 conditions of EIA 486.

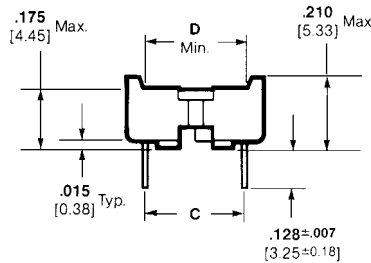
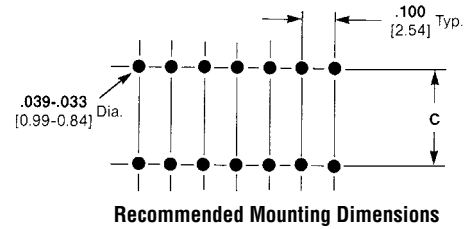
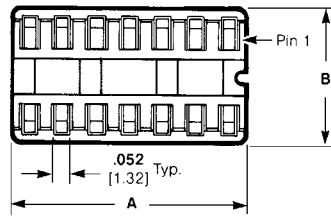

Sockets with Straight Solder Tails

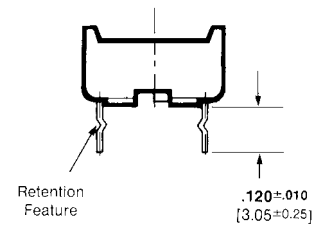

Sockets with Retention Feature Solder Tails

No. of Positions	Dimensions				Sockets with Straight Solder Tails ¹		Sockets with Retention Solder Tails ¹			
					Beryllium Copper	Phosphor Bronze	Beryllium Copper		Phosphor Bronze	
	A	B	C	D	.000030 [0.00076] ² Gold Plate	.000015 [0.00038] ² Gold Plate	Tinned	.000030 [0.00076] ² Gold Plate	Tinned	.000015 [0.00038] ² Gold Plate
6 ³	.295 7.49	.394 10.01	.300 7.62	.320 8.13	2-641296-2	2-641296-4	—	—	—	—
8 ³	.395 10.03	.394 10.01	.300 7.62	.320 8.13	2-640463-2	2-640463-4	2-641260-1	—	—	2-641260-4
14	.695 17.65	.394 10.01	.300 7.62	.320 8.13	2-641599-2	2-641599-4	2-641609-1	—	—	2-641609-4
16	.795 20.19	.394 10.01	.300 7.62	.320 8.13	2-641600-2	2-641600-4	2-641610-1	2-641610-2	—	2-641610-4
18	.895 22.73	.394 10.01	.300 7.62	.320 8.13	—	—	2-641611-1	—	—	—
20	.995 25.27	.394 10.01	.300 7.62	.320 8.13	2-641602-2	2-641602-4	2-641612-1	2-641612-2	—	2-641612-4
24	1.195 30.35	.394 10.01	.300 7.62	.320 8.13	2-641932-2	2-641932-4	2-641933-1	—	—	—
24	1.195 30.35	.694 17.63	.600 15.24	.620 15.75	2-641604-2	2-641604-4	641855-1	—	—	2-641614-4
28	1.395 35.43	.694 17.63	.600 15.24	.620 15.75	2-641605-2	2-641605-4	2-641615-1	2-641615-2	2-641615-3	2-641615-4
40	1.995 50.67	.694 17.63	.600 15.24	.620 15.75	2-641606-2	2-641606-4	2-641616-1	2-641616-2	—	—
42	2.095 53.21	.694 17.63	.600 15.24	.620 15.75	2-382374-2	—	—	—	—	—
48	2.395 60.83	.694 17.63	.600 15.24	.620 15.75	—	—	—	2-643576-2	—	2-643574-4

¹ ONLY sockets with straight solder tails are recommended for automatic insertion. All parts are packaged in plastic tubes. Sockets with retention feature are packaged in plastic tubes for handling and storage convenience only.

² Gold thickness in contact area; tin-lead plate on solder tails.

³ Closed frame design.

Dual Leaf (DL)

**Sockets accept .008—.014
[0.2—0.36] thick IC leads**

Material and Finish:

Housing — Glass-filled thermo-plastic, 94V-0 rated, black

Contacts — Phosphor bronze or beryllium copper with tin or gold plating (see table)

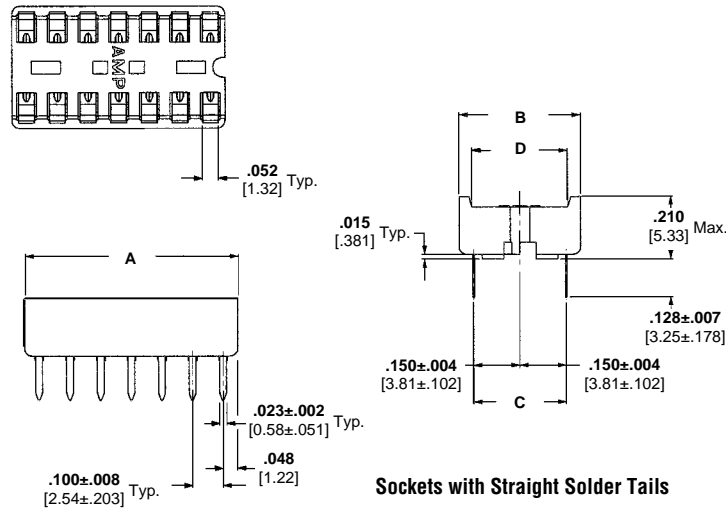

Sockets with Straight Solder Tails

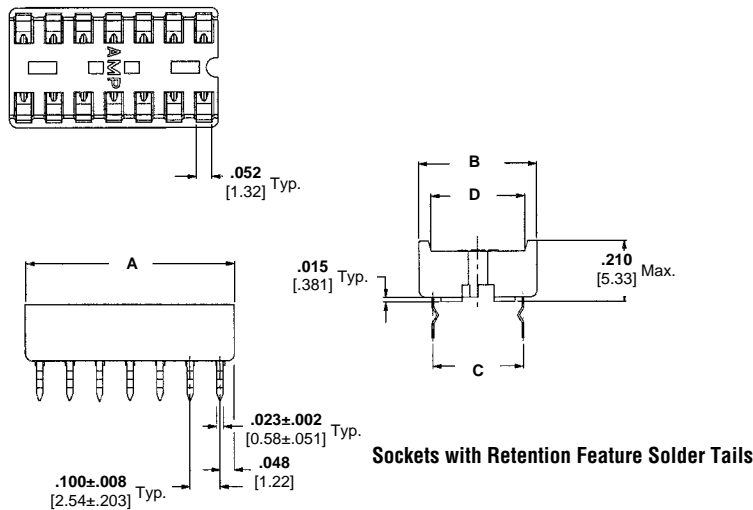

Sockets with Retention Feature Solder Tails

No. of Positions	Dimensions				Sockets with Straight Solder Tails ¹		Sockets with Retention Solder Tails ¹		
	A	B	C	D	Beryllium Copper	Phosphor Bronze	Beryllium Copper		Phosphor Bronze
					.000030 [0.00076] ² Gold Plate	.000015 [0.00038] ² Gold Plate	Tinned	Tinned	.000015 [.00038] ² Gold Plate
14	.695 17.65	.394 10.01	.300 7.62	.320 8.13	—	2-640357-4	2-641261-1	—	—
16	.795 20.19	.394 10.01	.300 7.62	.320 8.13	2-640358-2	2-640358-4	2-641262-1	—	2-641262-4
18	.895 22.73	.394 10.01	.300 7.62	.320 8.13	—	2-640359-4	—	—	—
20	.995 25.27	.394 10.01	.300 7.62	.320 8.13	2-640464-2	2-640464-4	2-641264-1	—	2-641264-4
24	1.195 30.35	.694 17.63	.600 15.24	.620 15.75	2-640361-2	2-640361-4	2-641266-1	—	—
28	1.395 35.43	.694 17.63	.600 15.24	.620 15.75	2-640362-2	2-640362-4	2-641267-1	2-641267-3	2-641267-4
40	1.995 50.67	.694 17.63	.600 15.24	.620 15.75	2-640379-2	2-640379-4	2-641268-1	—	2-641268-4

¹ ONLY sockets with straight solder tails are recommended for automatic insertion. All parts are packaged in plastic tubes. Sockets with retention feature are packaged in plastic tubes for handling and storage convenience only.

² Gold thickness in contact area; tin-lead plate on solder tails.

Open Frame

Material and Finish:

Housing — Glass-filled thermoplastic

Contacts — Beryllium copper

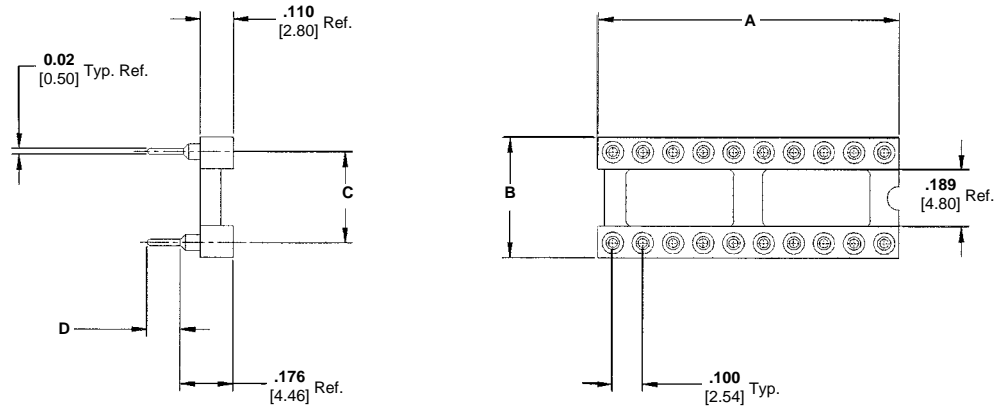

No. of Positions	Type/Centerline	Dimensions				Part Numbers
		A	B	C	D	
20	.300	.996 25.3	.394 10.1	.300 7.62	.112 2.84	345721-4
20	Wire Wrap Tail .300	.996 25.3	.394 10.1	.300 7.62	.051 12.95	3-345848-5
24	Wire Wrap Tail .300	1.20 30.4	.394 10.1	.300 7.62	.051 12.95	3-345850-5
28	Auto Insertable .600	1.40 35.5	.694 17.7	.600 15.24	.114 2.90	345870-4
32	.600	1.60 40.6	.694 17.7	.600 15.24	.112 2.84	345729-1

Economy Ladder Style, .300 Centerline

Material and Finish:

Housing — Glass-filled thermoplastic, black

Contacts — Phosphor bronze with tin plating

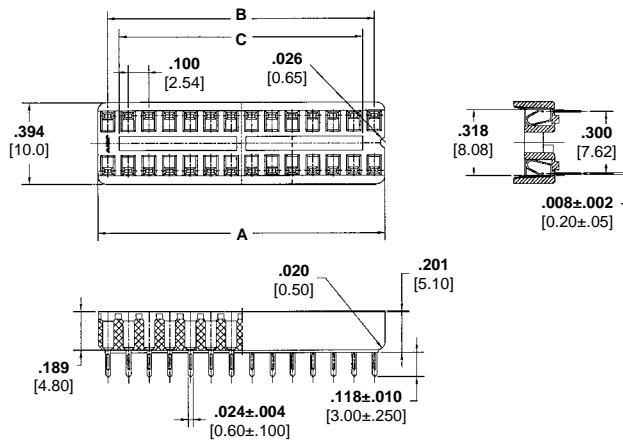

No. of Positions	Dimensions			Part Numbers
	A	B	C	
6	7.62 .300	5.08 .200	2.10 .083	390261-1
8	10.16 .400	7.62 .300	4.76 .187	390261-2
14	17.78 .700	15.24 .600	12.38 .487	390261-3
16	20.32 .800	17.78 .700	14.92 .587	390261-4
18	22.86 .900	20.32 .800	17.46 .687	390261-5
20	25.40 1.400	22.86 .900	20.00 .787	390261-6
22	27.94 1.100	25.40 1.000	22.54 .887	390261-7
24	30.48 1.200	27.94 1.100	25.10 .988	390261-8
28	35.56 1.400	33.02 1.300	30.12 1.185	390261-9
32	40.64 1.600	38.10 1.500	35.20 1.386	1-390261-0



Courtesy of Steven Engineering, Inc. • 230 Ryan Way, South San Francisco, CA, 94080-6370 • Main Office: (650) 588-9200 • Outside Local Area: (800) 258-9200 • www.stevenengineering.com

Economy Ladder Style, .600 Centerline

Material and Finish:

Housing — Glass-filled Thermoplastic, black

Contacts — Phosphor bronze with tin plating

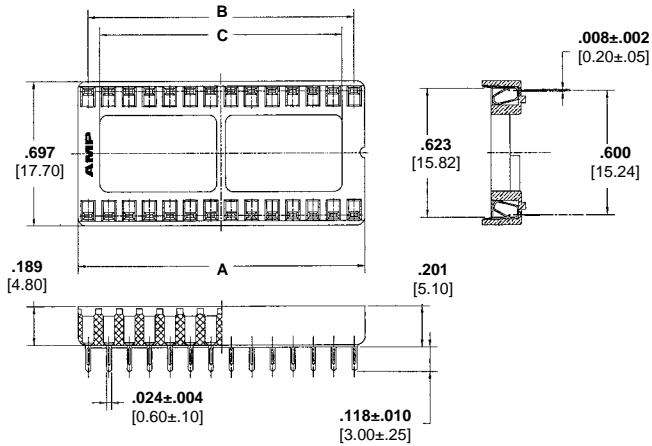

No. of Positions	Dimensions			Part Numbers .600 Centerline
	A	B	C	
24	30.48 1.200	27.94 1.100	25.10 .988	390262-1
28	35.56 1.400	33.02 1.300	30.12 1.185	390262-2
32	40.64 1.600	38.10 1.500	35.20 1.386	390262-3
40	50.80 2.000	48.26 1.900	45.36 1.790	390262-5
42	53.34 2.100	50.08 1.970	47.90 1.890	390262-6
48	60.96 2.400	58.42 2.300	55.52 2.190	390262-7

Economy Over-the-Component (OTC) Style, 15.24 Centerline

Material and Finish:

Housing — Glass-filled Thermoplastic, black

Contacts — Phosphor bronze with tin plating

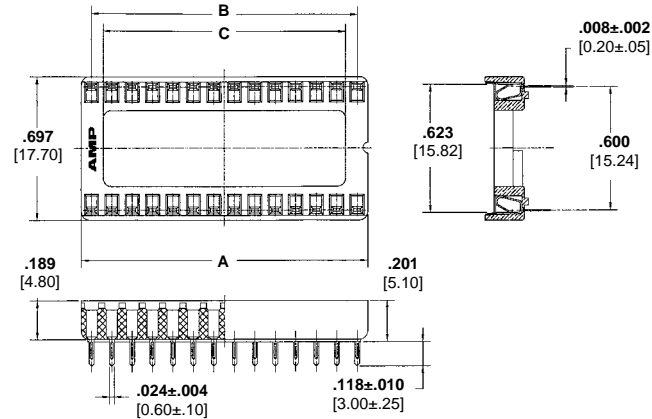

No. of Positions	Dimensions			Part Numbers 15.24 Centerline
	A	B	C	
24	25.10 .988	27.94 1.100	30.48 1.200	390263-7
28	30.12 1.190	33.02 1.300	35.56 1.400	390263-1
32	35.20 1.390	38.10 1.500	40.64 1.600	390263-2
40	45.36 1.790	48.26 1.900	50.80 2.000	390263-4
42	47.90 1.890	50.08 1.970	53.34 2.100	390263-5
48	55.52 2.190	58.42 2.300	60.96 2.400	390263-6

Dual Leaf (DL), Over-the-Component (OTC) Style

Sockets accept .008—.014 [0.2—0.36] thick IC leads

Material and Finish:

Housing — Glass-filled thermo-plastic, 94V-0 rated, black

Contacts — Phosphor bronze or beryllium copper with gold plating (see table)

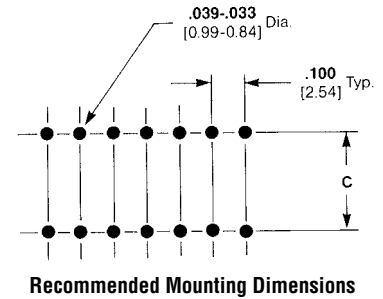
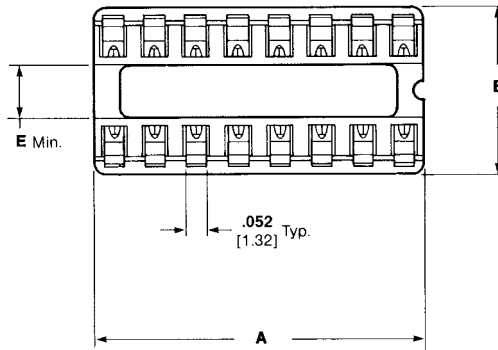
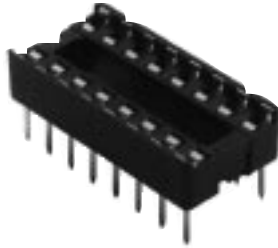

Recommended IC Leg Length:

- 1) .100 [2.54] min. for a reliable contact surface.
- 2) .120 [3.05] max. to allow IC body to seat on socket.
- 3) Longer legs may be used, but IC cannot be fully seated on seating plane.

Note: All socket positions have "True Closed Bottom" design which allows no solder or flux wicking at class 1 conditions of EIA 486.

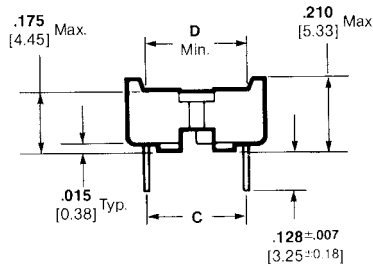

Sockets with Straight Solder Tails

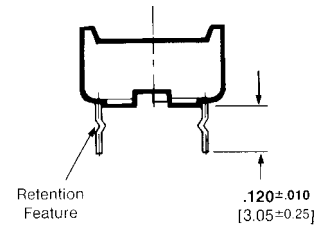

Sockets with Retention Feature Solder Tails

No. of Positions	Dimensions					Sockets with Straight Solder Tails		Sockets with Retention Solder Tails
						Beryllium Copper	Phosphor Bronze	Beryllium Copper
	A	B	C	D	E	.000030 [0.00076] ¹ Gold Plate	.000015 [0.00038] ¹ Gold Plate	.000030 [0.00076] ¹ Gold Plate
32	1.595 40.51	.694 17.63	.600 15.24	.620 15.75	.380 9.65	2-644018-2	2-644018-4	2-382189-2

¹ Gold thickness in contact area with tin-lead plate on solder tails. All parts packaged in plastic tubes.



Four-Fingered Contact & Solid Insulator

500 Series

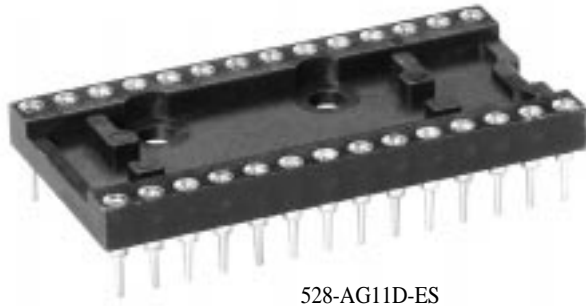

528-AG11D-ES

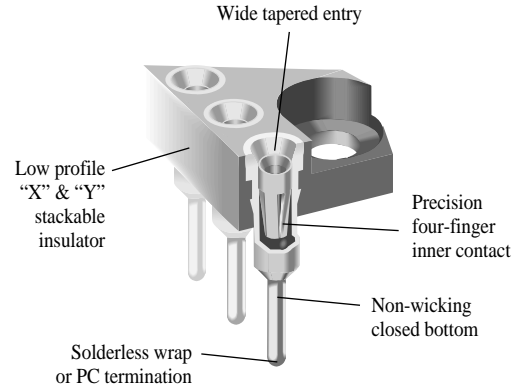

FEATURES:

The 500 Series Socket features a precision four-finger inner contact to produce the industry standard for high reliability screw machine sockets.

- Precision four-finger inner contact provides concentric funnel entry for easy flat and round lead insertion
- Machined (Premium Series) and stamped (Economy Series) contacts are available
- "X" & "Y" stackable
- Non-wicking, closed bottom sleeve gives 100% protection against flux and solder contamination. Choice of solderless wrap or PC termination
- Accommodates 6 through 40 pin DIPS, rectangular or round leads
-  Recognized under the Component Program of Underwriters Laboratories, Inc. file no. E111362
- Beryllium copper inner contact for maximum mechanical and electrical performance
- For extreme conditions involving shock and vibration, The AMP high retention series is available

APPLICATION DIMENSIONS:

- PCB Thickness Range: Standard .062" and .092" (1,57 and 2,34)
- PCB Hole Size Range: .035" ± .002" (0,89 ± 0,05) PC tail, .055" ± .003" (1,40 ± 0,08) solderless wrap
- IC Pin Dimension Range: .009" x .015" (0,23 x 0,38) through .011" x .020" (0,28 x 0,51) .016" to .021" (0,41 to 0,53) round lead, .105" (2,67) min. length

MATERIAL SPECIFICATIONS:

- Insulator.....Thermoplastic polyester, UL rated 94V-0
- SleeveMachined brass/formed copper
- ContactBeryllium copper
- Sleeve PlatingTin/lead or gold
- Contact PlatingPremium or Economy Series (ES) - gold or tin/lead
Economy Series (ESL) - low gold

PERFORMANCE SPECIFICATIONS:

MECHANICAL

- VibrationPassed MIL-STD-1344, Method 2005.1, Condition II, 10 G's
- Shock.....Passed MIL-STD-1344, Method 2004.1, Condition C, 100 G's
- DurabilityPassed MIL-STD-1344, Method 2016
- Normal Force125 Grams (4.4 oz.) average with .018" (0,46) dia. polished steel pin (Premium Series)
200 Grams (7.1 oz.) average with .018" (0,46) dia. polished steel pin (Economy Series)
- Inner Contact Retention ..
in Sleeve7.5 Lbs. per line average
- Sleeve Retention
in Plastic.....3.0 Lbs. per line minimum
- SolderabilityPassed MIL-STD-202F, Method 208
- Insertion ForcePremium - 134 Grams (4.7 oz.) average with a .018" (0,46) dia. polished steel pin
Economy - 179 Grams (6.3 oz.) average with a .018" (0,46) dia. polished steel pin
- Withdrawal Force63 Grams (2.2 oz.) average with a .018" (0,46) dia. polished steel pin (Premium and Economy)

ELECTRICAL

- Contact Resistance10 Milliohms max.
- Contact Rating.....3 Amps
- Capacitance1.0 pF per MIL-STD-202, Method 305 (contact to contact)
- Insulation Resistance.....5,000 Megohms min. @ 500 VDC per MIL-STD-1344, Method 3003.1
- Dielectric Withstanding
Voltage1,000 Volts RMS per MIL-STD-1344, Method 3001.1

ENVIRONMENTAL

- HumidityPassed MIL-STD-1344, Method 1002.2, Cond. II
- Thermal ShockPassed MIL-STD-1344, Method 1003.1, Cond. A
- Operation TemperatureGold inner contact -55°C to +125°C,
Tin/lead inner contact -55°C to +105°C

Four-Fingered Contact & Solid Insulator

500 Series

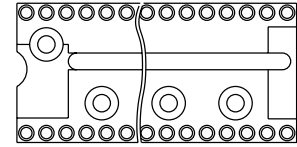

Figure 2

STANDARD CONFIGURATIONS

Number of Contacts	A	B*	C	Number of Contacts	A	B*	C
6	.300 (7,62)	.300 (7,62)	.400 (10,16)	24	1.200 (30,48)	.400 (10,16)	.500 (12,70)
8	.400 (10,16)			24	1.200 (30,48)	.600 (15,24)	.700 (45,72)
14	.700 (17,78)			28	1.400 (35,56)		
16	.800 (20,32)			32	1.600 (40,64)		
18	.900 (22,86)			36	1.800 (47,72)		
20	1.000 (25,40)			40	2.000 (50,80)		
22	1.150 (29,21)	.400 (10,16)	.500 (12,70)				

* Dimension B ± .005 (0,13)

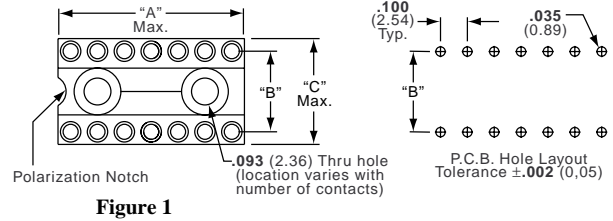
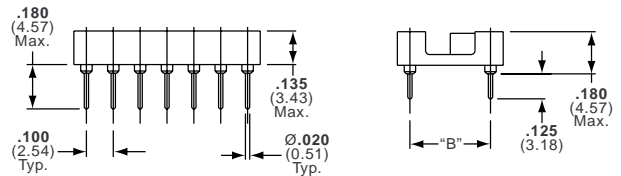

Figure 1



PART NUMBERS

Economy Series	Premium	Figure	Position	Centerline	Contact	Sleeve	Economy Series	Premium	Figure	Position	Centerline	Contact	Sleeve
506-AG10D-ES	506-AG10D	1	6	.300 (7,62)	Gold	Gold	524-AG65D-ES	524-AG65D	2	24	.400 (10,16)	Gold	Gold
506-AG10D-ESL	506-AG10D-ESL		6		Low Gold	Gold	524-AG65D-ESL	524-AG65D-ESL		24		Low Gold	Gold
506-AG11D-ES	506-AG11D		6		Gold	Tin/Lead	524-AG66D-ES	524-AG66D		24		Gold	Tin/Lead
506-AG11D-ESL	506-AG11D-ESL		6		Low Gold	Tin/Lead	524-AG66D-ESL	524-AG66D-ESL		24		Low Gold	Tin/Lead
506-AG12D-ES	506-AG12D		6		Tin/Lead	Tin/Lead	524-AG13D-ES	524-AG13D		24		Tin/Lead	Tin/Lead
508-AG10D-ES	508-AG10D		1		8	.300 (7,62)	Gold	Gold		524-AG10D-ES		524-AG10D	2
508-AG10D-ESL	508-AG10D-ESL	8		Low Gold	Gold		524-AG10D-ESL	524-AG10D-ESL	24	Low Gold	Gold		
508-AG11D-ES	508-AG11D	8		Gold	Tin/Lead		524-AG11D-ES	524-AG11D	24	Gold	Tin/Lead		
508-AG11D-ESL	508-AG11D-ESL	8		Low Gold	Tin/Lead		524-AG11D-ESL	524-AG11D-ESL	24	Low Gold	Tin/Lead		
508-AG12D-ES	508-AG12D	8		Tin/Lead	Tin/Lead		524-AG12D-ES	524-AG12D	24	Tin/Lead	Tin/Lead		
514-AG10D-ES	514-AG10D	1		14	.300 (7,62)		Gold	Gold	528-AG10D-ES	528-AG10D	2	28	
514-AG10D-ESL	514-AG10D-ESL		14	Low Gold		Gold	528-AG10D-ESL	528-AG10D-ESL	28	Low Gold		Gold	
514-AG11D-ES	514-AG11D		14	Gold		Tin/Lead	528-AG11D-ES	528-AG11D	28	Gold		Tin/Lead	
514-AG11D-ESL	514-AG11D-ESL		14	Low Gold		Tin/Lead	528-AG11D-ESL	528-AG11D-ESL	28	Low Gold		Tin/Lead	
514-AG12D-ES	514-AG12D		14	Tin/Lead		Tin/Lead	528-AG12D-ES	528-AG12D	28	Tin/Lead		Tin/Lead	
516-AG10D-ES	516-AG10D		1	16		.300 (7,62)	Gold	Gold	532-AG10D-ES	532-AG10D		2	32
516-AG10D-ESL	516-AG10D-ESL	16		Low Gold	Gold		532-AG10D-ESL	532-AG10D-ESL	32	Low Gold	Gold		
516-AG11D-ES	516-AG11D	16		Gold	Tin/Lead		532-AG11D-ES	532-AG11D	32	Gold	Tin/Lead		
516-AG11D-ESL	516-AG11D-ESL	16		Low Gold	Tin/Lead		532-AG11D-ESL	532-AG11D-ESL	32	Low Gold	Tin/Lead		
516-AG12D-ES	516-AG12D	16		Tin/Lead	Tin/Lead		532-AG12D-ES	532-AG12D	32	Tin/Lead	Tin/Lead		
518-AG10D-ES	518-AG10D	1		18	.300 (7,62)		Gold	Gold	536-AG10D-ES	536-AG10D	2		36
518-AG10D-ESL	518-AG10D-ESL		18	Low Gold		Gold	536-AG10D-ESL	536-AG10D-ESL	36	Low Gold		Gold	
518-AG11D-ES	518-AG11D		18	Gold		Tin/Lead	536-AG11D-ES	536-AG11D	36	Gold		Tin/Lead	
518-AG11D-ESL	518-AG11D-ESL		18	Low Gold		Tin/Lead	536-AG11D-ESL	536-AG11D-ESL	36	Low Gold		Tin/Lead	
518-AG12D-ES	518-AG12D		18	Tin/Lead		Tin/Lead	536-AG12D-ES	536-AG12D	36	Tin/Lead		Tin/Lead	
520-AG10D-ES	520-AG10D		1	20		.300 (7,62)	Gold	Gold	540-AG10D-ES	540-AG10D		2	40
520-AG10D-ESL	520-AG10D-ESL	20		Low Gold	Gold		540-AG10D-ESL	540-AG10D-ESL	40	Low Gold	Gold		
520-AG11D-ES	520-AG11D	20		Gold	Tin/Lead		540-AG11D-ES	540-AG11D	40	Gold	Tin/Lead		
520-AG11D-ESL	520-AG11D-ESL	20		Low Gold	Tin/Lead		540-AG11D-ESL	540-AG11D-ESL	40	Low Gold	Tin/Lead		
520-AG12D-ES	520-AG12D	20		Tin/Lead	Tin/Lead		540-AG12D-ES	540-AG12D	40	Tin/Lead	Tin/Lead		
522-AG10D-ES	522-AG10D	1		22	.400 (10,16)		Gold	Gold	Note: Part numbers in this chart and in detail shown refer to a .125" PC Tail Pin				
522-AG10D-ESL	522-AG10D-ESL		22	Low Gold		Gold							
522-AG11D-ES	522-AG11D		22	Gold		Tin/Lead							
522-AG11D-ESL	522-AG11D-ESL		22	Low Gold		Tin/Lead							
522-AG12D-ES	522-AG12D		22	Tin/Lead		Tin/Lead							

ECONOMY AND PREMIUM SERIES - .180" PC TAIL PINS

- 5XX-AG44D-XXX - Gold contact, tin/lead sleeve
- 5XX-AG45D-XXX - Gold contact, gold sleeve
- 5XX-AG143D-XXX - Tin/lead contact, tin/lead sleeve

For wire wrap sockets or 24 position on .400" (10,16) in high retention or .180 (4,57) tails, please consult Tyco Electronics.

HIGH RETENTION SERIES

- 5XX-AG34D - Gold contact, tin/lead sleeve
- 5XX-AG33D - Gold contact, gold sleeve
- 5XX-AG38D - Tin/lead contact, tin/lead sleeve

Note: Before ordering, see Cross Reference in Section 15 for equivalent Tyco Electronics Part Number.

Four-Fingered Contacts Disposable Carriers

700 Series



732-AG4D-ES

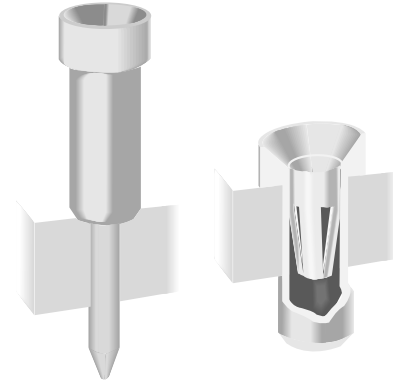

FEATURES:

A disposable aluminum carrier forms the backbone of the 700 Series socket, an innovative extension of the AMP precision four-fingered, inner contact concept. Conceived for IC applications requiring maximum air flow for cooling, the 700 Series eliminates heat entrapment associated with an insulator. Additional benefits are:

- Easy solder joint inspection-easy cleaning-easy repair
- “X” & “Y” stackability for circuit flexibility and optimum use of PCB real estate
- Gang insertion of socket pins into PC boards
- 100% non-wicking of flux and solder
- Standard or low profile PC board mounting
- Availability in 6 to 40 positions on .100”(2,54) centers and a wide variety of row spacing
- Machined (Premium Series) and stamped (Economy Series) contacts are available

APPLICATION DIMENSIONS:

- PCB Thickness Range: Standard .062" and .092" (1,57 and 2,34)
- IC Pin Dimension Range:.016" to .021" (0,41 to 0,53) dia., .105" (2,67) min. length
- PCB Hole Size Range: .035" ± .003" (0,89 ± 0,08) standard mount, .055 ± .001" (1,40 ± 0,03) low profile mount

MATERIAL SPECIFICATIONS:

- CarrierAluminum
- SleeveMachined brass
- ContactBeryllium copper
- Sleeve PlatingTin/lead or gold
- Contact PlatingPremium or Economy Series (ES) - gold or tin/lead
Economy Series (ESL) - low gold

PERFORMANCE SPECIFICATIONS:

MECHANICAL

- VibrationPassed MIL-STD-1344, Method 2005.1, Condition II, 10 G's
- ShockPassed MIL-STD-1344, Method 2004.1, Condition C, 100 G's
- DurabilityPassed MIL-STD-1344, Method 2016
- Normal Force125 Grams average with .018" (0,46) dia. polished steel pin (Premium Series)
200 Grams average with .018" (0,46) dia. polished steel pin (Economy Series)
- Inner Contact Retention
in Sleeve7.5 Lbs. per line average
- Sleeve Retention
in Plastic3.0 Lbs. per line minimum
- SolderabilityPassed MIL-STD-202F, Method 208
- Insertion ForcePremium - 134 Grams (4.7 oz.) average with a .018" (0,46) dia. polished steel pin
Economy - 179 Grams (6.3 oz.) average with a .018" (0,46) dia. polished steel pin
- Withdrawal Force 63 Grams (2.2 oz.) average with a (Premium and Economy) .018" (0,46) dia. polished steel pin

ELECTRICAL

- Contact Resistance10 Milliohms max.
- Contact Rating3 Amps
- Capacitance1.0 pF per MIL-STD-202, Method 305 (contact to contact)
- Insulation Resistance5,000 Megohms min. @ 500 VDC per MIL-STD-1344, Method 3003.1
- Dielectric Withstanding
Voltage1,000 Volts RMS per MIL-STD-1344, Method 3001.1

ENVIRONMENTAL

- HumidityPassed MIL-STD-1344, Method 1002.2, Cond. II
- Thermal ShockPassed MIL-STD-1344, Method 1003.1, Cond. A
- Operation TemperatureGold inner contact -55°C to +125°C,
Tin/lead inner contact -55°C to +105°C

Four-Fingered Contacts Disposable Carriers

700 Series

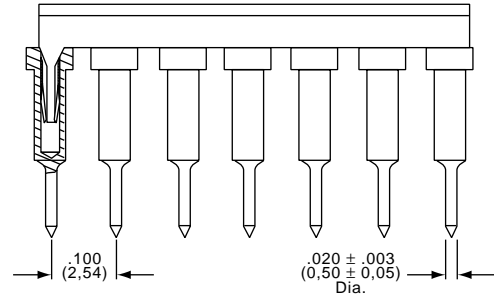
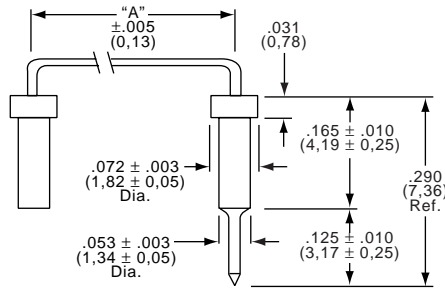

REPLACEMENT SOCKET TERMINALS

	Standard Mount	Low Profile Mount
Gold Sleeve	LSG-1AG14-1	LSG-1DG17-1
Tin/Lead Sleeve	LSG-1AG14-14	LSG-1DG17-14

MOUNTING OPTIONS

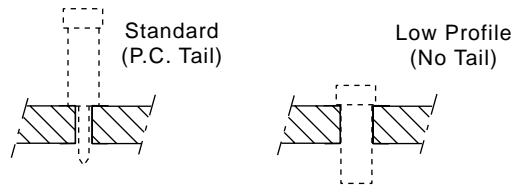

STANDARD MOUNT PART NUMBERS

Economy Series Part Number	Premium Series Part Number	Number of Contacts	Contact Plating	Sleeve Plating	A	Economy Series Part Number	Premium Series Part Number	Number of Contacts	Contact Plating	Sleeve Plating	A
706-AG2D-ES 706-AG2D-ESL	706-AG1D 706-AG2D	6 6 6	Gold Gold Low Gold	Gold Tin/Lead Tin/Lead	.300 (7,62)	724-AG2D-ES 724-AG2D-ESL	724-AG1D 724-AG2D —	24 24 24	Gold Gold Low Gold	Gold Tin/Lead Tin/Lead	.300 (7,62)
708-AG2D-ES 708-AG2D-ESL	708-AG1D 708-AG2D —	8 8 8	Gold Gold Low Gold	Gold Tin/Lead Tin/Lead		724-AG22D-ES 724-AG22D-ESL	724-AG21D 724-AG22D —	24 24 24	Gold Gold Low Gold	Gold Tin/Lead Tin/Lead	.400 (10,16)
714-AG2D-ES 714-AG2D-ESL	714-AG1D 714-AG2D —	14 14 14	Gold Gold Low Gold	Gold Tin/Lead Tin/Lead		724-AG4D-ES 724-AG4D-ESL	724-AG3D 724-AG4D —	24 24 24	Gold Gold Low Gold	Gold Tin/Lead Tin/Lead	.600 (15,24)
716-AG2D-ES 716-AG2D-ESL	716-AG1D 716-AG2D —	16 16 16	Gold Gold Low Gold	Gold Tin/Lead Tin/Lead		728-AG4D-ES 728-AG4D-ESL	728-AG3D 728-AG4D —	28 28 28	Gold Gold Low Gold	Gold Tin/Lead Tin/Lead	
718-AG2D-ES 718-AG2D-ESL	718-AG1D 718-AG2D —	18 18 18	Gold Gold Low Gold	Gold Tin/Lead Tin/Lead		732-AG4D-ES 732-AG4D-ESL	732-AG3D 732-AG4D —	32 32 32	Gold Gold Low Gold	Gold Tin/Lead Tin/Lead	
720-AG2D-ES 720-AG2D-ESL	720-AG1D 720-AG2D —	20 20 20	Gold Gold Low Gold	Gold Tin/Lead Tin/Lead		736-AG4D-ES 736-AG4D-ESL	736-AG3D 736-AG4D —	36 36 36	Gold Gold Low Gold	Gold Tin/Lead Tin/Lead	
722-AG2D-ES 722-AG2D-ESL	722-AG1D 722-AG2D —	22 22 22	Gold Gold Low Gold	Gold Tin/Lead Tin/Lead		740-AG4D-ES 740-AG4D-ESL	740-AG3D 740-AG4D —	40 40 40	Gold Gold Low Gold	Gold Tin/Lead Tin/Lead	
722-AG22D-ES 722-AG22D-ESL	722-AG21D 722-AG22D —	22 22 22	Gold Gold Low Gold	Gold Tin/Lead Tin/Lead							

LOW PROFILE PART NUMBERS

Low Profile Part Number	Number of Contacts	Outer Sleeve Plating	A	Low Profile Part Number	Number of Contacts	Outer Sleeve Plating	A
706-AG10D 706-AG20D	6 6	Gold Tin/Lead	.300 (7,62)	724-AG10D 724-AG20D	24 24	Gold Tin/Lead	.300 (7,62)
708-AG10D 708-AG20D	8 8	Gold Tin/Lead		724-AG410D 724-AG420D	24 24	Gold Tin/Lead	.400 (10,16)
714-AG10D 714-AG20D	14 14	Gold Tin/Lead		724-AG30D 724-AG40D	24 24	Gold Tin/Lead	.600 (15,24)
716-AG10D 716-AG20D	16 16	Gold Tin/Lead		728-AG30D 728-AG40D	28 28	Gold Tin/Lead	
718-AG10D 718-AG20D	18 18	Gold Tin/Lead		732-AG30D 732-AG40D	32 32	Gold Tin/Lead	
720-AG10D 720-AG20D	20 20	Gold Tin/Lead		736-AG30D 736-AG40D	36 36	Gold Tin/Lead	
722-AG10D 722-AG20D	22 22	Gold Tin/Lead		740-AG30D 740-AG40D	40 40	Gold Tin/Lead	
722-AG310D 722-AG320D	22 22	Gold Tin/Lead					

Note: Before ordering, see Cross Reference in Section 15 for equivalent Tyco Electronics Part Number.

Four-Fingered Contact Open Insulator

800 Series

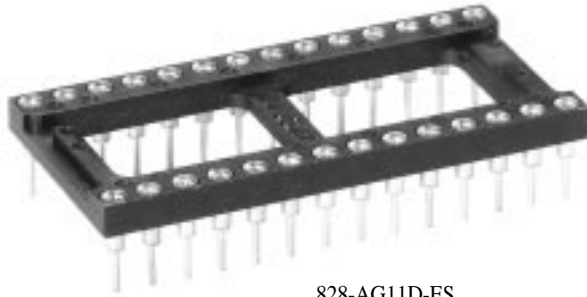

828-AG11D-ES

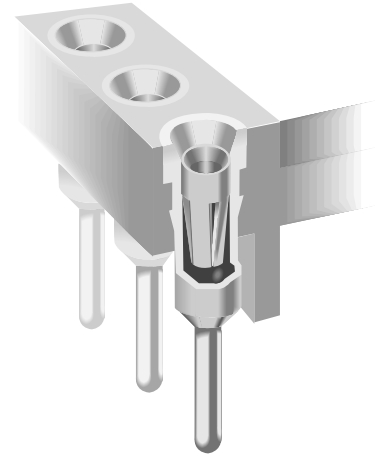

FEATURES:

The 800 Series combines precision four-fingered inner contacts with an open ladder insulator to produce the ultimate high-reliability socket.

- Precision four-fingered inner contacts provide concentric funnel entry for easy flat and round lead insertion
- “X” & “Y” stackable. Open ladder for cooling, cleaning and inspection. Low profile
- Accommodates 8 through 64 pins DIPS, rectangular or round IC leads
- Non-wicking, closed bottom sleeve provides 100% protection against flux and solder contamination. Choice of solderless wrap or PC termination
-  Recognized under the Component Program of Underwriter Laboratories, Inc. File No. E111362
- Beryllium copper inner contact for maximum mechanical and electrical performance
- Machined (Premium Series) and stamped (Economy Series) contacts are available
- For extreme conditions involving shock and vibration, The AMP high retention force contact is available

APPLICATION DIMENSIONS:

- PCB Thickness Range: Standard .062" and .092" (1,57 and 2,34)
- PCB Hole Size Range: .035" ± .002" (0,89 ± 0,05) PC tail, .055" ± .003" (1,40 ± 0,08) solderless wrap
- IC Pin Dimension Range: .009" x .015" (0,23 x 0,38) through .011" x .020" (0,28 x 0,51) .016" to .021" (0,41 to 0,53) round lead .105" (2,67) min. length

MATERIAL SPECIFICATIONS:

Insulator.....Thermoplastic polyester, UL rated 94V-0
 SleeveMachined brass
 ContactBeryllium copper
 Sleeve PlatingTin/lead or gold
 Contact PlatingPremium or Economy Series (ES) - gold or tin/lead
 Economy Series (ESL) - low gold

PERFORMANCE SPECIFICATIONS:

MECHANICAL

VibrationPassed MIL-STD-1344, Method 2005.1, Condition II, 10 G's
 ShockPassed MIL-STD-1344, Method 2004.1, Condition C, 100 G's
 DurabilityPassed MIL-STD-1344, Method 2016
 Normal Force125 Grams (4.4 oz.) average with .018" (0,46) dia. polished steel pin (Premium Series)
 200 Grams (7.1 oz.) average with .018" (0,46) dia. polished steel pin (Economy Series)
 Inner Contact Retention7.5 Lbs. per line average
 Sleeve Retention in Plastic3.0 Lbs. per line minimum
 SolderabilityPassed MIL-STD-202F, Method 208
 Insertion ForcePremium - 134 grams (4.7 oz.) average with a .018" (0,46) dia. polished steel pin
 Economy - 179 grams (6.3 oz.) average with a .018" (0,46) dia. polished steel pin
 Withdrawal Force63 Grams (2.2 oz.) average with a (Premium and Economy) .018" (0,46) dia. polished steel pin

ELECTRICAL

Contact Resistance10 Milliohms max.
 Contact Rating.....3 Amps
 Capacitance1 pF per MIL-STD-202, Method 305 (contact to contact)
 Insulation Resistance.....5,000 Megohms min. @ 500 VDC per MIL-STD-1344, Method 3003.1
 Dielectric Withstanding Voltage1,000 Volts RMS per MIL-STD-1344, Method 3001.1

ENVIRONMENTAL

HumidityPassed MIL-STD-1344, Method 1002.2, Cond. II
 Thermal ShockPassed MIL-STD-1344, Method 1003.1, Cond. A
 Operation TemperatureGold inner contact -55°C to +125°C, Tin/lead inner contact -55°C to +105°C

Four-Fingered Contact Open Insulator

800 Series STANDARD CONFIGURATIONS

Number of Contacts	A	B*	C	Number of Contacts	A	B*	C		
8	.400 (10,16)	.300 (7,62)	.400 (10,16)	24	1.200 (30,48)	.600 (15,24)	.700 (17,78)		
14	.700 (17,78)			28	1.400 (35,56)				
16	.800 (20,32)			32	1.600 (40,64)				
18	.900 (22,86)			36	1.800 (45,72)				
20	1.000 (25,40)	40	2.000 (50,80)						
22	1.100 (27,94)	.400 (10,16)	.500 (12,70)	42	2.100 (53,34)				
24	1.200 (30,48)	.300 (7,62)	.400 (10,16)	48	2.400 (60,96)				
24		.400 (10,16)	.500 (12,70)	64	3.200 (81,28)			.900 (22,86)	1.000 (25,40)

* Dimension B ± .005
(0,13)

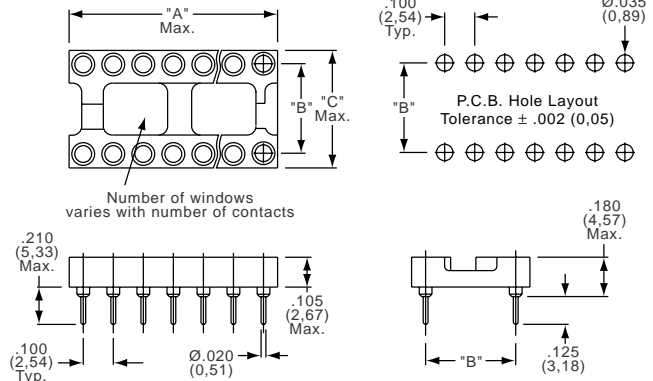

Note: Before ordering, see Cross Reference in Section 15 for equivalent Tyco Electronics Part Number.

PART NUMBERS

Economy Series	Premium Series	Position	Centerline	Contact	Sleeve	Economy Series	Premium Series	Position	Centerline	Contact	Sleeve
348465	348465	6	.300 (7,62)	Gold	Tin/Lead	348479	348479	24		Gold	Tin/Lead
348466	348466	8		Gold	Tin/Lead	824-AG10D-ES	824-AG10D	24		Gold	Tin/Lead
808-AG10D-ES	808-AG10D	8		Gold	Gold	824-AG10D-ESL		24	.600 (15,24)	Low Gold	Gold
808-AG10D-ESL		8	.300 (7,62)	Low Gold	Gold	824-AG11D-ES	824-AG11D	24		Gold	Tin/Lead
808-AG11D-ES	808-AG11D	8		Gold	Tin/Lead	824-AG11D-ESL		24		Low Gold	Tin/Lead
808-AG11D-ESL		8		Low Gold	Tin/Lead	824-AG12D-ES	824-AG12D	24		Tin/Lead	Tin/Lead
808-AG12D-ES	808-AG12D	8		Tin/Lead	Tin/Lead	348474	348474	28	.300 (7,62)	Gold	Tin/Lead
348467	348467	10	.300 (7,62)	Gold	Tin/Lead	348477	348477	28	.400 (10,16)	Gold	Tin/Lead
348468	348468	14		Gold	Tin/Lead	348480	348480	28		Gold	Tin/Lead
814-AG10D-ES	814-AG10D	14		Gold	Gold	828-AG10D-ES	828-AG10D	28		Gold	Gold
814-AG10D-ESL		14	.300 (7,62)	Low Gold	Gold	828-AG10D-ESL		28	.600 (15,24)	Low Gold	Gold
814-AG11D-ES	814-AG11D	14		Gold	Tin/Lead	828-AG11D-ES	828-AG11D	28		Gold	Tin/Lead
814-AG11D-ESL		14		Low Gold	Tin/Lead	828-AG11D-ESL		28		Low Gold	Tin/Lead
814-AG12D-ES	814-AG12D	14		Tin/Lead	Tin/Lead	828-AG12D-ES	828-AG12D	28		Tin/Lead	Tin/Lead
348469	348469	16		Gold	Tin/Lead	348478	348478	32	.400 (10,16)	Gold	Tin/Lead
816-AG10D-ES	816-AG10D	16		Gold	Gold	348481	348481	32		Gold	Tin/Lead
816-AG10D-ESL		16	.300 (7,62)	Low Gold	Gold	832-AG10D-ES	832-AG10D	32		Gold	Gold
816-AG11D-ES	816-AG11D	16		Gold	Tin/Lead	832-AG10D-ESL		32	.600 (15,24)	Low Gold	Gold
816-AG11D-ESL		16		Low Gold	Tin/Lead	832-AG11D-ES	832-AG11D	32		Gold	Tin/Lead
816-AG12D-ES	816-AG12D	16		Tin/Lead	Tin/Lead	832-AG11D-ESL		32		Low Gold	Tin/Lead
						832-AG12D-ES	832-AG12D	32		Tin/Lead	Tin/Lead
348470	348470	18		Gold	Tin/Lead	348482	348482	36		Gold	Tin/Lead
818-AG10D-ES	818-AG10D	18		Gold	Gold	836-AG10D-ES	836-AG10D	36		Gold	Gold
818-AG10D-ESL		18	.300 (7,62)	Low Gold	Gold	836-AG10D-ESL		36	.600 (15,24)	Low Gold	Gold
818-AG11D-ES	818-AG11D	18		Gold	Tin/Lead	836-AG11D-ES	836-AG11D	36		Gold	Tin/Lead
818-AG11D-ESL		18		Low Gold	Tin/Lead	836-AG11D-ESL		36		Low Gold	Tin/Lead
818-AG12D-ES	818-AG12D	18		Tin/Lead	Tin/Lead	836-AG12D-ES	836-AG12D	36		Tin/Lead	Tin/Lead
348471	348471	20		Gold	Tin/Lead	348483	348483	40		Gold	Tin/Lead
820-AG10D-ES	820-AG10D	20		Gold	Gold	840-AG10D-ES	840-AG10D	40		Gold	Gold
820-AG10D-ESL		20	.300 (7,62)	Low Gold	Gold	840-AG10D-ESL		40	.600 (15,24)	Low Gold	Gold
820-AG11D-ES	820-AG11D	20		Gold	Tin/Lead	840-AG11D-ES	840-AG11D	40		Gold	Tin/Lead
820-AG11D-ESL		20		Low Gold	Tin/Lead	840-AG11D-ESL		40		Low Gold	Tin/Lead
820-AG12D-ES	820-AG12D	20		Tin/Lead	Tin/Lead	840-AG12D-ES	840-AG12D	40		Tin/Lead	Tin/Lead
348472	348472	22	.300 (7,62)	Gold	Tin/Lead	348484	348484	42		Gold	Tin/Lead
348475	348475	22		Gold	Tin/Lead	842-AG10D-ES	842-AG10D	42		Gold	Gold
822-AG10D-ES	822-AG10D	22		Gold	Gold	842-AG10D-ESL		42	.600 (15,24)	Low Gold	Gold
822-AG10D-ESL		22	.400 (10,16)	Low Gold	Gold	842-AG11D-ES	842-AG11D	42		Gold	Tin/Lead
822-AG11D-ES	822-AG11D	22		Gold	Tin/Lead	842-AG11D-ESL		42		Low Gold	Tin/Lead
822-AG11D-ESL		22		Low Gold	Tin/Lead	842-AG12D-ES	842-AG12D	42		Tin/Lead	Tin/Lead
822-AG12D-ES	822-AG12D	22		Tin/Lead	Tin/Lead	348485	348485	48		Gold	Tin/Lead
348473	348473	24		Gold	Tin/Lead	848-AG10D-ES	848-AG10D	48		Gold	Gold
824-AG30D-ES	824-AG30D	24		Gold	Gold	848-AG10D-ESL		48		Low Gold	Gold
824-AG30D-ESL		24	.300 (7,62)	Low Gold	Gold	848-AG11D-ES	848-AG11D	48		Gold	Tin/Lead
824-AG31D-ES	824-AG31D	24		Gold	Tin/Lead	848-AG11D-ESL		48		Low Gold	Tin/Lead
824-AG31D-ESL		24		Low Gold	Tin/Lead	848-AG12D-ES	848-AG12D	48		Tin/Lead	Tin/Lead
824-AG32D-ES	824-AG32D	24		Tin/Lead	Tin/Lead	348486	348486	50	.600 (15,24)	Gold	Tin/Lead
348476	348476	24		Gold	Tin/Lead	348488	348488	50	.900 (22,86)	Gold	Tin/Lead
824-AG65D-ES	824-AG65D	24		Gold	Gold						
824-AG65D-ESL		24	.400 (10,16)	Low Gold	Gold						
824-AG66D-ES	824-AG66D	24		Gold	Tin/Lead						
824-AG66D-ESL		24		Low Gold	Tin/Lead						
824-AG14D-ES	824-AG14D	24		Tin/Lead	Tin/Lead						

Note: Before ordering, see Cross Reference in Section 15 for equivalent Tyco Electronics Part Number.



Sockets

Four Fingered Contact Open Insulator

PART NUMBERS

Economy Series	Premium Series	Position	Centerline	Contact	Sleeve	Economy Series	Premium Series	Position	Centerline	Contact	Sleeve
348487	348487	52	.600 (15,24)	Gold	Tin/Lead	864-AG10D-ESL		64		Low Gold	Gold
348489	348489	52	.900 (22,86)	Gold	Tin/Lead	864-AG11D-ES	864-AG11D	64	.900 (22,86)	Gold	Tin/Lead
348490	348490	64	.900 (22,86)	Gold	Tin/Lead	864-AG11D-ESL		64		Low Gold	Tin/Lead
864-AG10D-ES	864-AG10D	64		Gold	Gold	864-AG12D-ES	864-AG12D	64		Tin/Lead	Tin/Lead

Economy and Premium Series - .180" (4,57) PC Tail Pins

- 8XX-AG44D-XXX - Gold contact, tin/lead sleeve
- 8XX-AG45D-XXX - Gold contact, gold sleeve
- 8XX-AG43D-XXX - Tin/lead contact, tin/lead sleeve

High Retention Series

- 8XX-AG34D - Gold contact, tin/lead sleeve
- 8XX-AG33D - Gold contact, gold sleeve
- 8XX-AG38D - Tin/lead contact, tin/lead sleeve

Note: Part numbers in this chart and in detail shown refer to a .125" (3,18) PC Tail Pin

For wire-wrap sockets or 24 position on .300" (7,62) or .400" (10,16) in high retention or .180" (4,57) tails, please consult Tyco Electronics.

Note: Before ordering, see Cross Reference in Section 15 for equivalent Tyco Electronics Part Number.

Surface Mount

800 SM Series



814-AG11SM

FEATURES:

Tyco Electronics offers the precision machined 800SM Series which achieves compliancy to the board surface and is designed for high temperatures typical of vapor phase and infrared reflow soldering.

- "Butt" style terminals float in plastic housing for compliancy to board surface
- Precision four-fingered inner contacts provide concentric funnel entry for easy flat or round insertion

APPLICATION DIMENSIONS:

- PCB Thickness Range: Standard .062" and .092" (1,57 and 2,34)
- IC Pin Dimension Range: .009" x .015" (0,23 x 0,38) through .011" x .020" (0,28 x 0,51) .016" to .021" (0,41 to 0,53) round lead .105" (2,67) min. length

MATERIAL SPECIFICATIONS:

Insulator.....Thermoplastic polyester, UL rated 94V-0
 Outer SleeveBrass
 Contacts.....Beryllium copper
 Sleeve PlatingTin/lead
 Contact PlatingGold or tin/lead

PERFORMANCE SPECIFICATIONS:

MECHANICAL

VibrationPassed MIL-STD-1344, Method 2005.1, Condition II, 10 G's
 Shock.....Passed MIL-STD-1344, Method 2004.1, Condition C, 100 G's
 DurabilityPassed MIL-STD-1344, Method 2016
 Inner Contact Retention7.5 Lbs. per line average
 SolderabilityPassed MIL-STD-202F, Method 208
 Insertion Force179 Grams (6.3 oz.) average with a .018" (0,46) dia. polished steel pin
 Withdrawal Force63 Grams (2.2 oz.) average with a .018" (0,46) dia. polished steel pin

ELECTRICAL

Contact Resistance10 Milliohms max.
 Contact Rating.....3 Amps
 Capacitance1.0 pF per MIL-STD-202, Method 305 (contact to contact)
 Insulation Resistance.....5,000 Megohms min. @ 500 VDC per MIL-STD-1344, Method 3003.1
 Dielectric Withstanding Voltage1,000 Volts RMS per MIL-STD-1344, Method 3001.1

ENVIRONMENTAL

HumidityPassed MIL-STD-1344, Method 1002.2, Cond. II
 Thermal ShockPassed MIL-STD-1344, Method 1003.1, Cond. A
 Operation TemperatureGold inner contact -55°C to +125°C, Tin/lead inner contact -55°C to +105°C

Surface Mount

800 SM Series

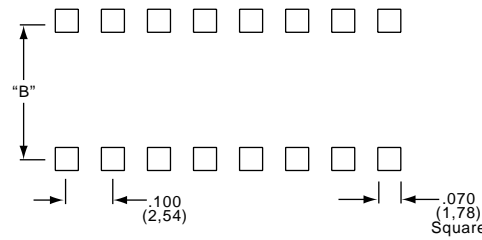
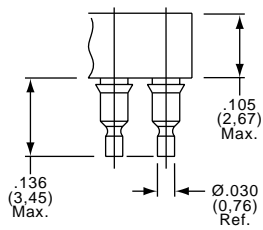

Recommended Pad Pattern
Tolerance ± .002 (0,05)

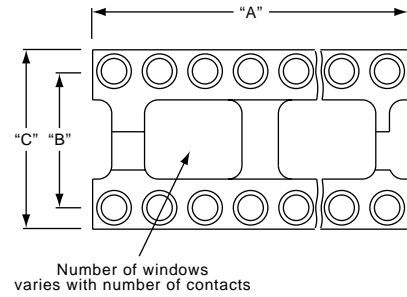

STANDARD CONFIGURATIONS

Number of Contacts	A	B*	C	Number of Contacts	A	B*	C		
8	.400 (10,16)	.300 (7,62)	.400 (10,16)	24	1.200 (30,48)	.600 (15,24)	.700 (17,78)		
14	.700 (17,78)			28	1.400 (35,36)				
16	.800 (20,32)			32	1.600 (40,64)				
18	.900 (22,86)			36	1.800 (45,72)				
20	1.000 (25,40)			40	2.000 (50,80)				
22	1.100 (27,94)	.400 (10,16)	.500 (12,70)	42	2.100 (53,34)				
24	1.200 (30,48)	.300 (7,62)	.400 (10,16)	48	2.400 (60,96)				
24	1.200 (30,48)	.400 (10,16)	.500 (12,70)	64	3.200 (81,28)			.900 (22,86)	1.000 (25,40)

* Dimension B ± .005
(0,13)

PART NUMBERS

Part Number	Position	Centerline	Contact	Part Number	Position	Centerline	Contact
808-AG11SM	8	.300	Gold	824-AG11SM	24	.600	Gold
808-AG12SM	8	(7,62)	Tin/Lead	824-AG12SM	24	(15,24)	Tin/Lead
814-AG11SM	14	.300	Gold	828-AG11SM	28	.600	Gold
814-AG12SM	14	(7,62)	Tin/Lead	828-AG12SM	28	(15,24)	Tin/Lead
816-AG11SM	16	.300	Gold	832-AG11SM	32	.600	Gold
816-AG12SM	16	(7,62)	Tin/Lead	832-AG12SM	32	(15,24)	Tin/Lead
818-AG11SM	18	.300	Gold	836-AG11SM	36	.600	Gold
818-AG12SM	18	(7,62)	Tin/Lead	836-AG12SM	36	(15,24)	Tin/Lead
820-AG11SM	20	.300	Gold	840-AG11SM	40	.600	Gold
820-AG12SM	20	(7,62)	Tin/Lead	840-AG12SM	40	(15,24)	Tin/Lead
822-AG11SM	22	.300	Gold	842-AG11SM	42	.600	Gold
822-AG12SM	22	(7,62)	Tin/Lead	842-AG12SM	42	(15,24)	Tin/Lead
824-AG31SM	24	.300	Gold	848-AG11SM	48	.600	Gold
824-AG32SM	24	(7,62)	Tin/Lead	848-AG12SM	48	(15,24)	Tin/Lead
824-AG66SM	24	.400	Gold	864-AG11SM	64	.900	Gold
824-AG14SM	24	(10,16)	Tin/Lead	864-AG12SM	64	(22,86)	Tin/Lead

Note: Before ordering, see Cross Reference in Section 15 for equivalent Tyco Electronics Part Number.

5 Sockets

DIP Insertion and Withdrawal Tools

TI/TW Series



T114-1

DIP WITHDRAWAL TOOL

Part Number	Description
T114-1	Simple tool that assists removal of DIP from top side of panel

Note: Before ordering, see Cross Reference in Section 15 for equivalent Tyco Electronics Part Number.

The insertion and extraction of dual inline integrated circuit packages has always presented the problem of aligning all leads simultaneously. The TI/TW family of tools solve this problem with a range of tools for 8 thru 40 pin devices.

FEATURES:

- Smooth insertion and withdrawal of ICs.
- Prevents bending of IC leads while inserting and removing.
- Ensures greater socketing reliability.
- Uses limited amount of board space for support.
- Available in flexible roll pouch for convenient organization of service tool kit.



TI 8136-14/16

INSERTION TOOLS

Part Number	Accepts Components
TI8136-8	8 leads on .300 (7,62) centers
TI8136-14/16	14 and 16 leads on .300 (7,62) centers
TI8136-18/20	18 and 20 leads on .300 (7,62) centers
TI8136-22	22 leads on .400 (10,16) centers
TI8136-24/28	24 and 28 leads on .600 (15,24) centers
TI8136-32/40	32 thru 40 leads on .600 (15,24) centers



TW 8136-24/28

WITHDRAWAL TOOLS

Part Number	Accepts Components
TW8136-8	8 leads on .300 (7,62) centers
TW8136-14/20	14 and 16 leads on .300 (7,62) centers
TW8136-22	22 leads on .400 (10,16) centers
TW8136-24/28	24 and 28 leads on .600 (15,24) centers
TW8136-32/40	32 thru 40 leads on .600 (15,24) centers
TK8136-1G1	8 thru 40 position insertion and extraction tools in a 26-pocket, reinforced, double thick vinyl roll pouch

Note: Before ordering, see Cross Reference in Section 15 for equivalent Tyco Electronics Part Number.

DIP Withdrawal Tools

TX Series

FEATURES:

- The extractor tool uses the shoulders of the IC socket or surface of the printed wiring board as a stable lifting platform, designed for no slippage or misalignment during removal of the IC, as often happens when using traditional IC removal tools.
- Can be grounded to protect delicate MOS devices from static discharge.
- Lead screw adjustment applies a constant parallel axial force, eliminating problems with bent or broken IC pins.
- These extractor tools remove soldered or socketed ICs from printed wiring boards. Soldered ICs are removed by applying heat to the soldered junction, while gently turning knob to exert a continuous force.

OPERATION:

Plunger button opens and closes support legs encasing the IC. Turning knob raises the IC from its socketed or soldered position.

IC WITHDRAWAL TOOL

The TX 8136 Family of precision lead extractor tools provide for a controlled, aligned and parallel withdrawal of ICs. This saves you many times the cost of the tool by protecting expensive IC devices from pin damage.



TX 8136-40

WITHDRAWAL TOOLS

Part Number	Description
TX8136-14/20	14 to 20 pins .300" (7,62) rows
TX8136-22	22 pins .400" (10,16) rows
TX8136-24	24 pins .600 (15,24) rows
TX8136-40	40 pins .600 (15,24) rows
TX8136-64	64 pins .900" (22,86) rows

Note: Before ordering, see Cross Reference in Section 15 for equivalent Tyco Electronics Part Number.

Solder Tail Dual Leaf (DL) Contact

Product Facts

- Low Profile — .210 [5.33] max. seating plane above pc board
- Dual wiping contacts
- Face wipe contacts for high reliability and constant, low resistance
- Anti-overstress prevents contact damage
- Large target area with tapered lead-in ramps for easy SIP insertion
- “True closed bottom” design inhibits solder wicking and flux contamination
- Stackable end-to-end and side-to-side (brickwalling) for high board density
- Housing standoffs and slots facilitate board cleaning
- Family of 3 through 25 positions
- Retention-style solder tails
- Visual polarization
- Meets the material requirements of Table 23.1 of UL 1410 Standard for Television Receivers and Video Products
- Tin or gold plated beryllium copper or tin plated phosphor bronze contacts
- Designed to meet EIA RS-415, MIL-S-83734 and stringent computer specifications
- Recognized under the Component Program of Underwriters Laboratories Inc., File E28476
- Certified by Canadian Standards Association File No. LR 7189

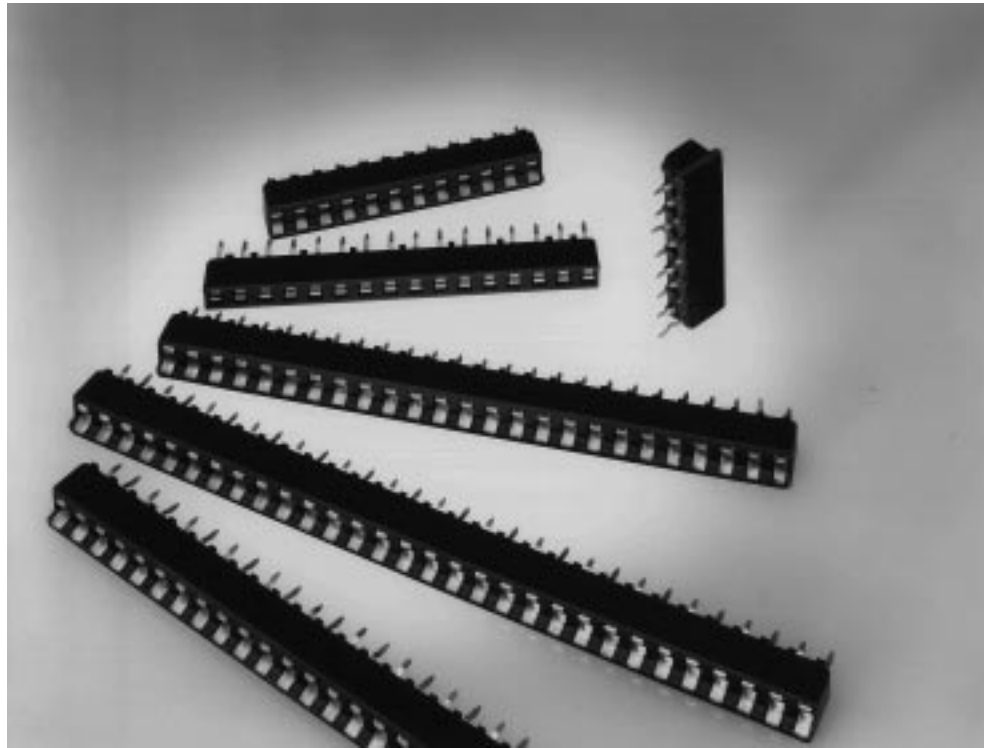

The Dual Leaf (DL) SIP socket family provides high quality at low cost with superior handling characteristics. Sockets are available in 3- through 25-position sizes with dual wiping contacts in tin and gold plating over beryllium copper or economical tin plated phosphor bronze. The large target area of the contacts and tapered side ramps in the housing promote easy entry of a SIP package. Internal anti-overstress walls prevent contact damage. These stackable housings feature a “true closed bottom” design which prevents solder or flux wicking at class 1 conditions of EIA 486.

Standoffs provide board clearance for proper cleaning after soldering. Sockets are available with retention feature solder tails for self retention in the pc board during handling and flow soldering.

Housings are constructed from self-extinguishing glass-filled polyester, 94V-0 rated material and meet the material requirements of Table 23.1 of UL 1410 Standard for Television Receivers and Video Products.

The DL SIP Socket family meets the requirements of EIA RS-415, MIL-S-83734 and the most stringent specifications of main-frame computer manufacturers.

Performance Characteristics:

- Rating** — Signal application only
- Contact Resistance** — 20 milliohms max. (initial)
30 milliohms max. (after test)
- Dielectric Withstanding Voltage** — 1000 VRMS min.
- Insulation Resistance** — 5000 megohms min.
- Capacitance** — 0.5 picofarad max.
- Operating Temperature** —
-55°C to +105°C (tin)
-55°C to +125°C (gold)
- Vibration** — 15 Gs, 10-2000-10 Hz in 20 minutes
- Shock** — 100 Gs sawtooth, 6 shocks
- Engaging Force** — 340 grams [3.33 N] max. (.013 [0.33] pin)
- Separating Force** — 25 grams [0.24 N] (.008 [0.2] pin)

Technical Documents:

- Product Specification**
108-1066 Standard
- Application Specification**
114-1049

Solder Tail Dual Leaf (DL)

Sockets accept .008—.014 [0.2—0.36] thick x .030 [0.76] max. wide rectangular IC leads

Material and Finish:

Housing — Glass-filled thermo-plastic, 94V-0 rated, black

Contacts — Beryllium copper with gold or tin plating, or phosphor bronze with tin plating (see table)

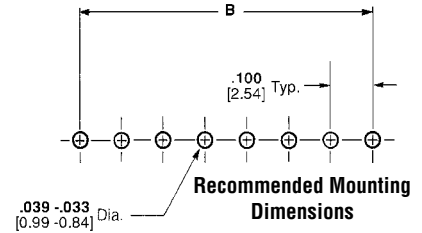
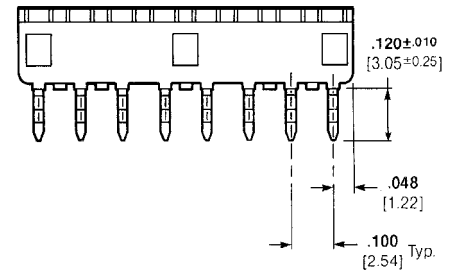
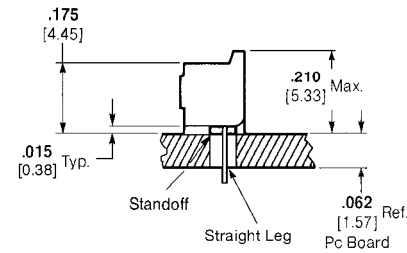
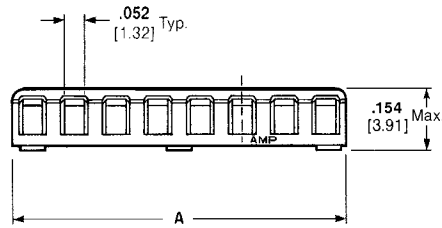
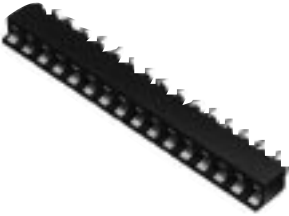

No. of Positions	Dimensions		Straight Solder Tail		Retention Solder Tail		Package Quantities				
	A	B	Beryllium Copper		Phosphor Bronze		Qty. Per Tray	Trays Per Box	Total Qty. Per Box		
			Tinned	.000030 [0.00076] Gold Plate	Tinned	Tinned				.000030 [0.00076] Gold Plate	
3	.295 7.49	.200 5.08	382437-1	—	382437-3	—	—	740	4	2960	
4	.395 10.03	.300 7.62	382438-1	—	382438-3	—	—	560	4	2240	
8	.795 20.19	.700 17.78	643640-1	643640-2	—	643640-6	—	643640-8	280	4	1120
9	.895 22.73	.800 20.32	—	—	—	643641-6	—	643641-8	240	4	960
10	.995 25.27	.900 22.86	643642-1	643642-2	—	643642-6	—	643642-8	220	4	880
11	1.095 27.81	1.000 25.40	—	643643-2	—	643643-6	—	643643-8	200	4	800
12	1.195 30.35	1.100 27.94	643644-1	—	643644-3	643644-6	—	643644-8	180	4	720
13	1.295 32.89	1.200 30.48	—	643645-2	643645-3	643645-6	—	—	160	4	640
14	1.395 35.43	1.300 33.02	643646-1	—	643646-3	643646-6	—	643646-8	160	4	640
15	1.495 37.97	1.400 35.56	643647-1	—	—	643647-6	—	643647-8	140	4	560
16	1.595 40.51	1.500 38.10	643648-1	—	643648-3	—	—	643648-8	140	4	560
17	1.695 43.05	1.600 40.64	643649-1	—	—	—	—	643649-8	120	4	480
18	1.795 45.59	1.700 43.18	643650-1	—	—	643650-6	—	—	120	4	480
19	1.895 48.13	1.800 45.72	—	—	643651-3	—	—	643651-8	100	4	400
20	1.995 50.75	1.900 48.26	643652-1	—	643652-3	643652-6	643652-7	—	100	4	400
21	2.095 53.21	2.000 50.80	643653-1	—	643653-3	643653-6	—	—	100	4	400
22	2.195 55.75	2.100 53.34	643654-1	—	—	—	—	—	100	4	400
23	2.295 58.29	2.200 55.88	—	—	—	643655-6	—	643655-8	80	4	320
24	2.395 60.83	2.300 58.42	—	—	2-643656-3*	—	—	—	16	140	2240
25	2.495 63.37	2.400 60.96	643657-1	643657-2	—	643657-6	—	—	80	4	320
29	2.895 73.53	2.800 71.12	—	—	643661-3	—	—	—	60	4	240
30	2.995 76.07	2.900 73.66	643662-1	—	643662-3	—	—	—	60	4	240

*Packaged in tubes.

Products for Industrial & Commercial Applications

Dimensions are shown for reference purposes only.

Dimensions are in inches and millimeters unless otherwise specified. Values in brackets are metric equivalents.

Specifications subject to change.

Technical Support Center
1-800-522-6752
www.tycoelectronics.com

Terminal Strips, Four-Fingered Contact

500 Series



510AG91D08ESL

FEATURES:

- Available in strips of 1 to 20
- Breakaway feature for breaking strips into any desired shorter lengths (no special tooling required)
- Contact features closed end construction eliminating any solder or flux wicking problems
- Two-piece tapered entry closed entry inner contact and outer sleeve
- Accepts any IC lead and component leads .016" - .021" (0,41 - 0,53) dia., .105" (2,67) minimum length
- Uses: microprocessor sockets, hybrid IC sockets, Q.I.L. sockets, component sockets and test points
- Machined (Premium Series) and stamped (Economy Series) contacts are available

APPLICATION DIMENSIONS:

- PCB Thickness Range: Standard .062" and .092" (1,57 and 2,34)
- PCB Hole Size Range: .035" ± .003" (0,89 ± 0,08) PC tail, .055" ± .003" (1,40 ± 0,08) Solderless wrap
- IC Pin Dimension Range: .009" x .015" (0,23 x 0,38) through .011" x .020" (0,28 x 0,51) .016" x .021" (0,41 x 0,53) round lead .105" (2,67) min. length

MATERIAL SPECIFICATIONS:

Insulator.....Thermoplastic polyester, UL rated 94V-0
 Inner Contact.....Beryllium copper, gold or tin/lead plated
 SleeveBrass, gold or tin/lead plated

PART NUMBERS

Economy Series	Premium Series	Number of Contacts	Contact Plating	Sleeve Plating	Dim. A
510AG90D10ES	510-AG90D-10	10	Gold	Gold	1.000 (25,40)
510AG90D10ESL			Low Gold	Gold	
510AG91D10ES	510-AG91D-10		Gold	Tin/Lead	
510AG91D10ESL			Low Gold	Tin/lead	
510AG92D10ES	510-AG92D-10	20	Tin/Lead	Tin/Lead	2.000 (50,80)
510AG90D20ES	510-AG90D-20		Gold	Gold	
510AG90D20ESL			Low Gold	Gold	
510AG91D20ES	510-AG91D-20		Gold	Tin/Lead	
510AG91D20ESL			Low Gold	Tin/lead	
510AG92D20ES	510-AG92D-20		Tin/Lead	Tin/Lead	

For sizes not shown or for wire-wrap termination, please consult Tyco Electronics.

ECONOMY AND PREMIUM SERIES - .180 PC TAIL PINS

510-AG45D-XX, 510AG45DXXES(L) - Gold Contact, Gold Sleeve
 510-AG44D-XX, 510AG44DXXES(L) - Gold Contact, Tin/Lead Sleeve
 510-AG42D-XX, 510AG42DXXES(L) - Tin/Lead Contact, Tin/Lead Sleeve

Note: Before ordering, see Cross Reference in Section 15 for equivalent Tyco Electronics Part Number.

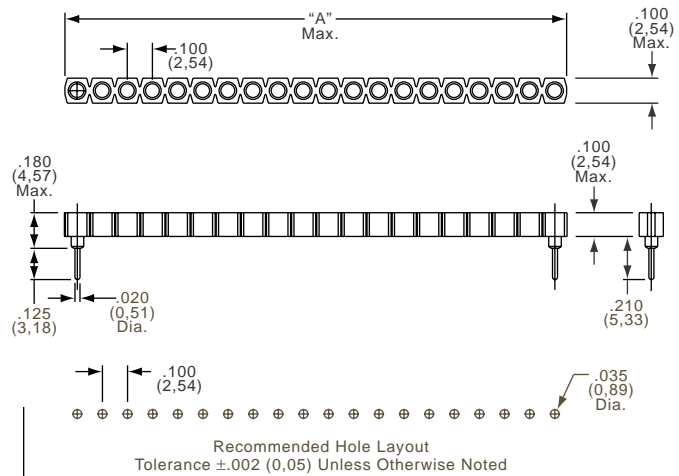

PERFORMANCE SPECIFICATIONS:

MECHANICAL

VibrationPassed MIL-STD-1344, Method 2005.1, Condition II, 10 G's
 ShockPassed MIL-STD-1344, Method 2004.1, Condition C, 100 G's
 DurabilityPassed MIL-STD-1344, Method 2016
 Normal Force125 Grams (4.4 oz.) average with .018" (0,46) dia. polished steel pin (Premium Series)
200 Grams (7.1 oz.) average with .018" (0,46) dia. polished steel pin (Economy Series)
 Inner Contact Retention ..
 in Sleeve7.5 Lbs. per line average
 Sleeve Retention
 in Plastic3.0 Lbs. per line minimum
 SolderabilityPassed MIL-STD-202F, Method 208
 Insertion ForcePremium - 134 Grams (4.7 oz.) average with a .018" (0,46) dia. polished steel pin
 Economy - 179 Grams (6.3 oz.) average with a .018" (0,46) dia. polished steel pin
 Withdrawal Force63 Grams (2.2 oz.) average with a .018" (0,46) dia. polished steel pin



ELECTRICAL

Contact Resistance10 Milliohms max.
 Contact Rating3 Amps
 Capacitance1.0 pF per MIL-STD-202, Method 305 (contact to contact)
 Insulation Resistance.....5,000 Megohms min. @ 500 VDC per MIL-STD-1344, Method 3003.1
 Dielectric Withstanding
 Voltage1,000 Volts RMS per MIL-STD-1344, Method 3001.1

ENVIRONMENTAL

HumidityPassed MIL-STD-1344, Method 1002.2, Cond. II
 Thermal ShockPassed MIL-STD-1344, Method 1003.1, Cond. A
 Operation TemperatureGold inner contact -55°C to +125°C
 Tin/lead inner contact -55°C to +105°C

Product Facts

- Metal latches eliminate breakage
- Reliable contact design for durability
- Heat resistant housings withstand most hostile environments
- Designed for robotic assembly to facilitate automatic manufacturing operations
- Very low insertion force for easy module insertion
- Positive polarization prevents misinsertion
- Recognized under the Component Program of Underwriters Laboratories Inc., File E28476 
- Certified by Canadian Standards Association File No. LR 7189 

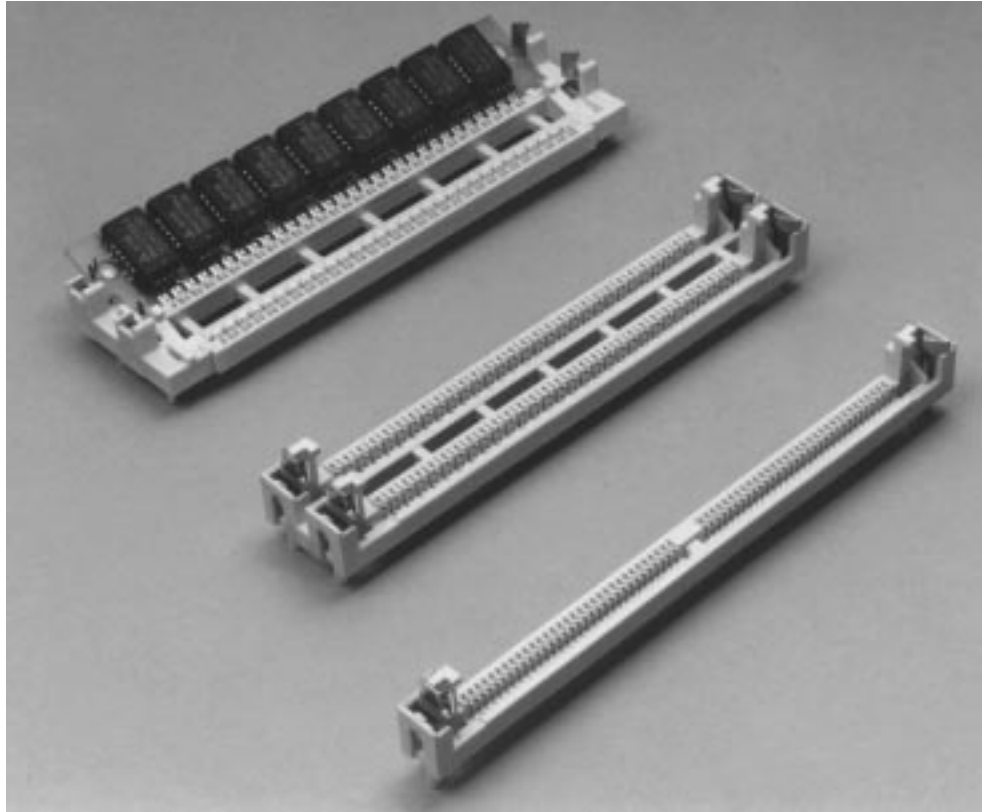

Tyco Electronics offers a metal latch version of its MICRO-EDGE SIMM sockets. This feature eliminates the breakage associated with the misuse of SIMM sockets. In addition, the metal latches will prevent shaving and/or skiving, as happens with plastic latches, due to inconsistent manufacturing methods of the board edges.

The metal latch MICRO-EDGE sockets are available in .050 [1.27] centerline configurations.

All are available in vertical and angled/low profile designs, with and without center posts.

Performance Characteristics:

Current Rating — 1 ampere max.

Termination Resistance (Dry Circuit) — 30 milliohms max. (initial)

Dielectric Withstanding Voltage — 1.0 KVAC

Insulation Resistance — 10,000 megohms min. (initial)

Capacitance — 1.0 picofarad max.

Operating Temperature — -55°C to +105°C

Durability — 25 cycles min.

Technical Documents:

Product Specification
108-1095

Application Specification
114-1061

Instruction Sheet
408-9413

Courtesy of Steven Engineering, Inc. • 230 Ryan Way, South San Francisco, CA, 94080-6370 • Main Office: (650) 588-9200 • Outside Local Area: (800) 258-9200 • www.stevenengineering.com

Vertical, .050 [1.27] Centerline

Single Row (Right Polarization)

Material and Finish:

Housing — Liquid Crystal Polymer (LCP) UL 94V-0

Contacts — Phosphor bronze with .000200 [0.00508] min. thick tin-lead over .000050 [0.00127] min. thick nickel or .000030 [0.00076] min. thick gold on contact area and .000150 [0.0038] min. thick tin-lead on solder tails, all over .000050 [0.00127] min. thick nickel

Latch — Brass, nickel plated

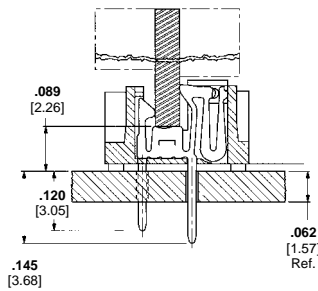

Section A-A

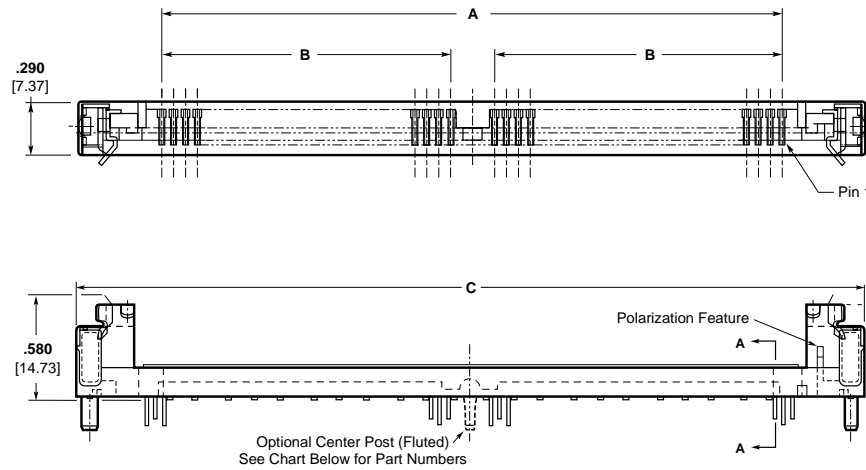

No. of Positions	Dimensions			Part Numbers			
	A	B	C	Tin Plate		Gold Plate	
				With Fluted Center Post	Without Center Post	With Fluted Center Post	Without Center Post
72	3.750 95.25	1.750 44.45	4.550 115.57	822021-4	822019-4	822032-4	822031-4
80	4.150 105.41	1.950 49.53	4.950 125.73	822021-5	—	—	—

Single Row (Left Polarization)

Material and Finish:

Housing — Liquid Crystal Polymer (LCP) UL 94V-0

Contacts — Phosphor bronze with .000200 [0.00508] min. thick tin-lead over .000050 [0.00127] min. thick nickel or .000030 [0.00076] min. thick gold on contact area and .000150 [0.0038] min. thick tin-lead on solder tails, all over .000050 [0.00127] min. thick nickel

Latch — Brass, nickel plated

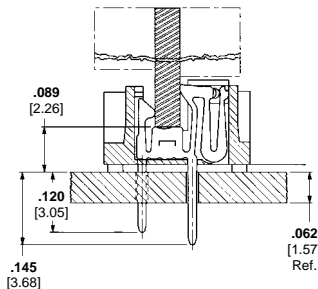

Section A-A

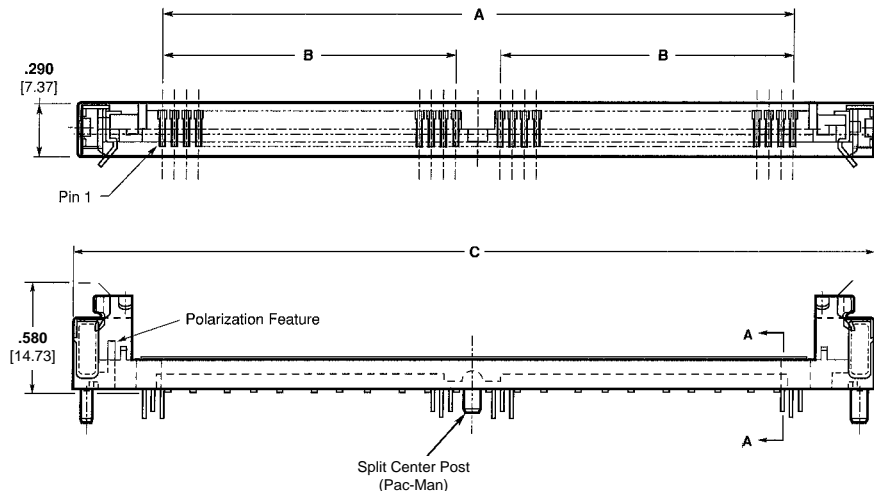

No. of Positions	Dimensions			Part Numbers	
	A	B	C	Tin Plate	Gold Plate
				822030-3	821997-3
72	3.750 95.25	1.750 44.45	4.550 115.57	822030-3	821997-3
80	4.150 105.41	1.950 49.53	4.950 125.73	822030-4	—

22° Angular, .050 [1.27] Centerline

Low Profile (22°) Single Row with Optional Fluted or Split Retention Post

Material and Finish:

Housing — Liquid Crystal Polymer (LCP) UL 94V-0

Contacts — Phosphor bronze with .000200 [0.00508] min. thick tin-lead over .000050 [0.00127] min. thick nickel or .000030 [0.00076] min. thick gold on contact area and .000150 [0.0038] min. thick tin-lead on solder tails, all over .000050 [0.00127] min. thick nickel

Latch — Stainless steel

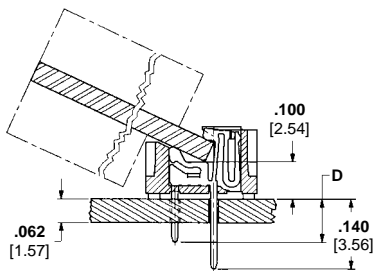

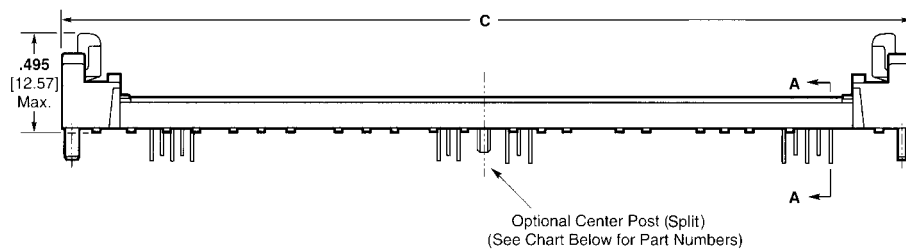
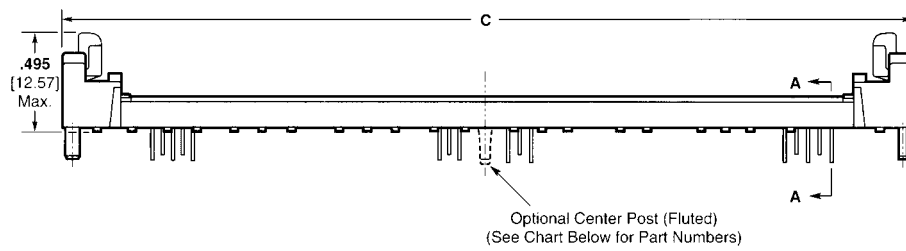
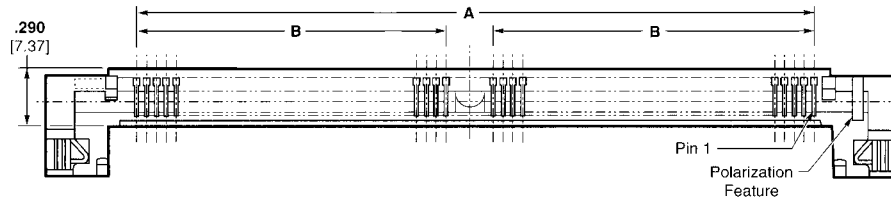

Section A-A



No. of Positions	Dimensions				Part Numbers					
	A	B	C	D	Tin Plate			Gold Plate		
					With Fluted Center Post	With Split Center Post	Without Center Post	With Fluted Center Post	With Split Center Post	Without Center Post
72	3.750 95.25	1.750 44.45	4.540 115.32	.115 2.92	822134-3	822110-3	822330-3	822137-3	822097-3	822138-3
				.140 3.56	—	822469-3	—	—	—	—
80	4.150 105.41	1.950 49.53	4.940 125.48	.115 2.92	822134-4	—	—	—	—	—
				.140 3.56	—	822469-4	—	—	—	—

Product Facts

- Accepts module boards in a thickness range of .047-.054 [1.19-1.37] to allow the use of JEDEC standard boards
- Polarized posts on socket provide a means of properly orienting the socket on the pc board
- Pin 1 indicator in the socket orients the module board to the socket
- .050 [1.27] centerline sockets offer three profile heights — .125 [3.18], .160 [4.06] and .250 [6.35] to allow the use of single- and dual-sided boards, and the placement of components beneath the module board if required
- Very low insertion force for easy module insertion
- Metal latches provide superior strength
- Center post on .050 [1.27] product provides retention in the pc board through the soldering process
- Recognized under the Component Program of Underwriters Laboratories Inc., File E28476 
- Certified by Canadian Standards Association File No. LR 7189 



Tyco Electronics developed the SIMM II Right Angle Sockets for interfacing Single In-Line Memory Module (SIMM) boards horizontally to the pc board while using a traditional cam-in approach. Available in .050 [1.27] centerline with gold and tin plating options, the sockets are designed to accept the JEDEC standard pc board thickness range of .047-.054 [1.19-1.37].

In order to allow for many different customer designs, the .050 [1.27] centerline sockets are available in three card slot heights — .125 [3.18], .160 [4.06] and .250 [6.35]. This multi-height capability allows customers to use single- or dual-sided module boards while providing the lowest overall height for packaging. The .125 [3.18] height version provides an extremely low profile interface while maintaining easy insertion and extraction within

restricted packaging specifications.

A very low insertion force is required to install the module board. To install, simply angle the module into the socket card slot, then pivot the module board into position where it is secured by the locking latches.

The housing is made from liquid crystal polymer (LCP), assuring strong durable ramps. The latches for the .125 [3.18] height versions are made from LCP while all other versions have metal latches. Polarizing posts coincide with mounting holes in the pc board to prevent misinsertion.

Performance Characteristics:

Current Rating — 1 ampere max.

Termination Resistance (Dry Circuit) — 20 milliohms max. (initial)

Dielectric Withstanding Voltage — 1 KVAC

Insulation Resistance — 10,000 megohms min. (initial)

Operating Temperature — -55°C to +85°C continuous, +105°C peak

Durability — 25 cycles min.

Technical Documents:

Product Specification
108-1297

Application Specification
114-1060

.050 [1.27] Centerline

Material and Finish:

Housing — Liquid Crystal Polymer (LCP), glass filled, UL 94V-0

Contacts — Phosphor bronze with .000150 [0.0038] min. thick tin-lead over .000050 [0.00127] min. thick nickel or Duplex .000030 [0.00076] min. thick gold on contact area and .000150 [0.0038] min. thick tin-lead on solder tails, all over .000050 [0.00127] min. thick nickel

Latch — Brass with nickel plate on .160 [4.06] and .250 [6.35] height versions and LCP on .125 [3.18] version

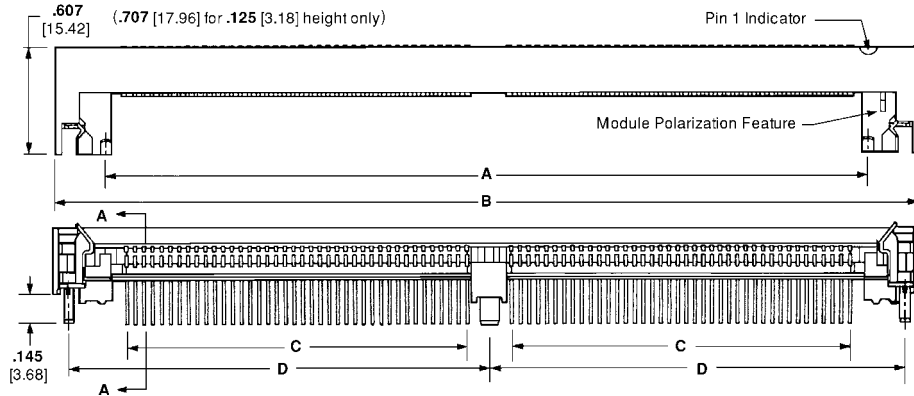

Card Slot Height G	Dimensions	
	H	J
.125 3.18	.325 8.26	.304 7.72
.160 4.06	.360 9.14	.339 8.61
.250 6.35	.450 11.43	.429 10.90

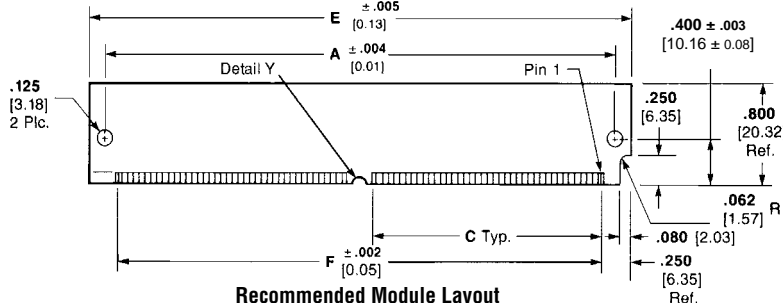
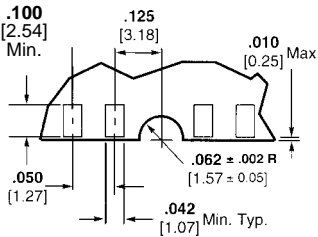
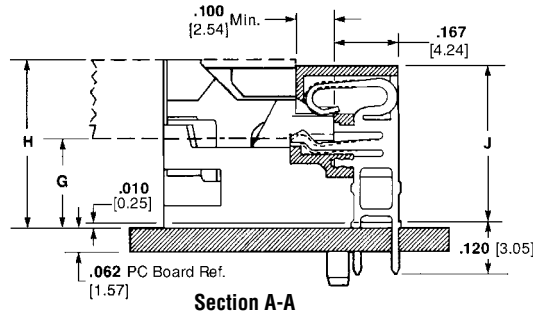

Detail Y

Recommended Module Layout

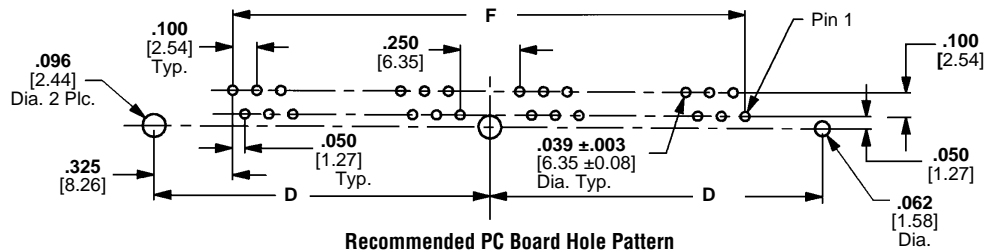

Recommended PC Board Hole Pattern

No. of Positions	Dimensions						.125 [3.18] Height ¹		.160 [4.06] Height ²		.250 [6.35] Height ²	
	A	B	C	D	E	F	Gold Plate	Tin Plate	Gold Plate	Tin Plate	Gold Plate	
	72	3.984 101.19	4.550 115.57	1.750 44.45	2.200 55.88	4.250 107.95	3.750 95.25	7-382481-2	7-382482-2	7-382483-2	7-382486-2	7-382487-2
80	4.384 111.35	4.950 125.73	1.950 49.53	2.400 60.96	4.650 118.11	4.150 105.41	—	—	—	8-382486-0	—	

¹ Has plastic latches (plastic latches extend .707 [17.96] from back of housing).

² Has metal latches.

Note: Metal latch version shown for purposes of illustration.

Dual Read-Out Sockets for SDRAM and SGRAM

Product Facts

- Sockets Dual Read-Out SDRAM and SGRAM
- Cam-in module loading provides easy insertion
- Positive wipe on pads during module insertion
- Contact performance in excess of 100 MHz
- Increased lead-in geometry reduces insertion force
- Module stabilization features

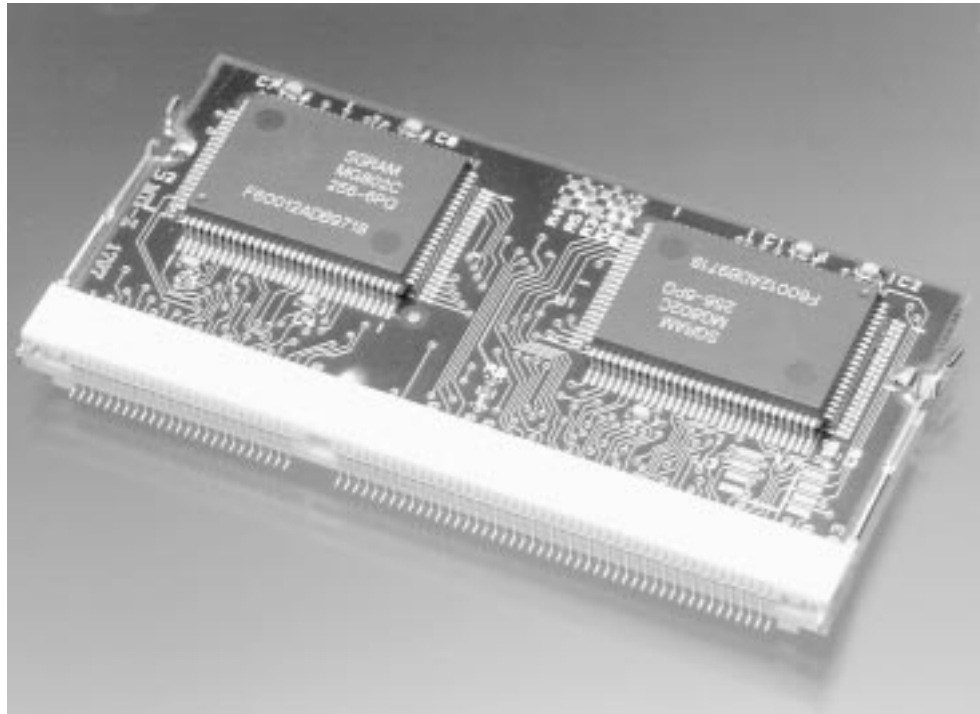

SO DIMM sockets are available in a 144-position dual read-out version for SDRAM (Synchronous Dynamic Random Access Memory) and a version for SGRAM (Synchronous Graphic Random Access Memory).

For use in Frame Buffer Memory applications, where height off the board is important, this socket is ideal because of its right angle, low vertical height design.

Sockets use 0.8mm centerline technology to provide more than triple the density of standard SIMM sockets and provide highly

reliable, low cost, space saving benefits. Easy aligning, cam-in module loading and dual locking levers provide for simple do-it-yourself upgrades.

The SDRAM version is available in four card slot heights of 2.1mm [.083 in.], 3.3mm [.130 in.], 3.7mm [.146 in.] and 8.0mm [.315 in.] for 3.3V power supplies.

The SGRAM version is available in two card slot heights; 3.7mm [.146] and 8.0 [.315] for 3.3V power supplies. Hard tray and tape-and-reel packaging are available for automatic placement. Contact Tyco Electronics for part number availability.

Performance Characteristics:

Operating Temperature —
-55°C to +105°C

Termination Resistance (Dry Circuit) — 30 milliohms max., initial $\Delta R=20$ milliohms max., final

Dielectric Strength — 1.0 KVAC
Insulation Resistance — 10,000 megohms min.

Durability — 25 cycles

PCB Mating Force — 59.8 N [13.44 lb] max., initial

Technical Documents:

Product Specification
108-1739

For complete product information, order Catalog 1307767

144 Positions — 0.8 mm SO DIMM

Material and Finish:

Housing — Nylon, UL94V-0 rated; color: natural

Contact — Phosphor bronze with 0.00025 mm [.0000098 in.] min. thick gold over 0.001 mm [.0000393 in.] min. thick nickel in contact area and gold flash over 0.001 mm [.0000393 in.] min. thick nickel in soldering area.

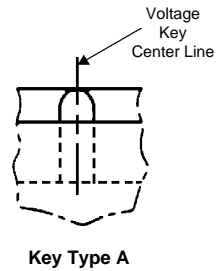
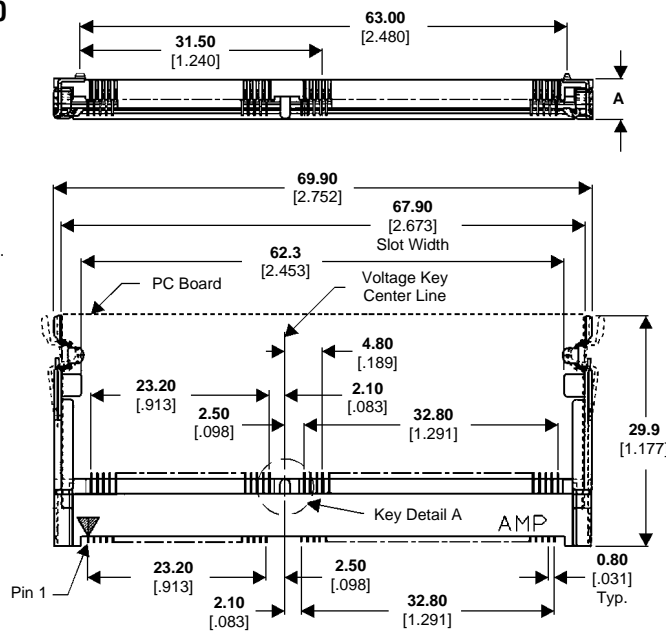

Housing Style	Dim. A	Power Supply: 3.3 Volt Key Type A
Standard	5.20 .205	390113-1
Low-Profile	4.00 .157	390114-1
High-Profile	5.60 .220	390112-1
Ultra-High	9.90 .390	390322-1

Dual Read-Out for SGRAM Memory Modules

144 Positions — 0.8 mm SO DIMM

Material and Finish

Housing — Nylon, UL94V-0 rated; color: natural

Contact — Phosphor bronze with 0.00025 mm [.0000098 in.] min. thick gold over 0.0013-0.004 mm [.000051-.000157 in.] thick nickel in contact area and 0.0033-0.0064 mm [.000150-.000250 in.] thick tin-lead over 0.0013-0.004 mm [.000051-.000157 in.] thick nickel in soldering area.

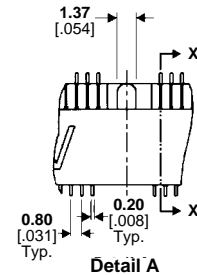
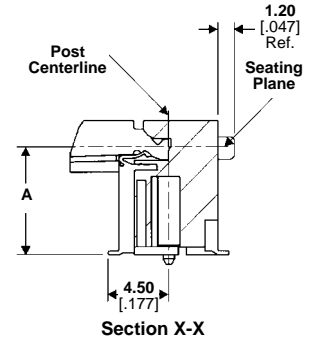
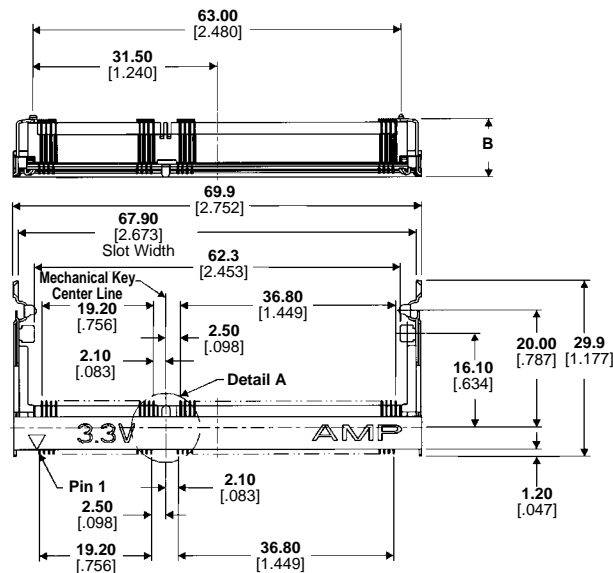



Dimensions		Part Numbers
A	B	
8.00 .315	9.90 .390	390110-1
3.70 .146	5.60 .220	390111-1

For complete product information, order Catalog 1307767

Dual Read-Out for 8 Byte Memory Modules

Product Facts

- Sockets Dual Read-Out 8-Byte DRAM DIMM boards for 64-bit data bus
- Staggered contact heights to reduce module insertion force
- Enhanced built-in lever-type module extractors
- Contact performance in excess of 100 MHz
- Multiple keying possibilities
- Socket-to-board hold-down features available
- Applicable to PC-100 & PC-133 Modules
- Recognized under the Component Program of Underwriters Laboratories Inc.,  File E28476
- Certified by Canadian Standards Association  File No. LR 7189

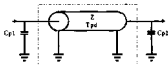

AMP Single Line and MultiLine Models are available for DIMM II Sockets at www.amp.com/simulation or email at modeling@tycoelectronics.com

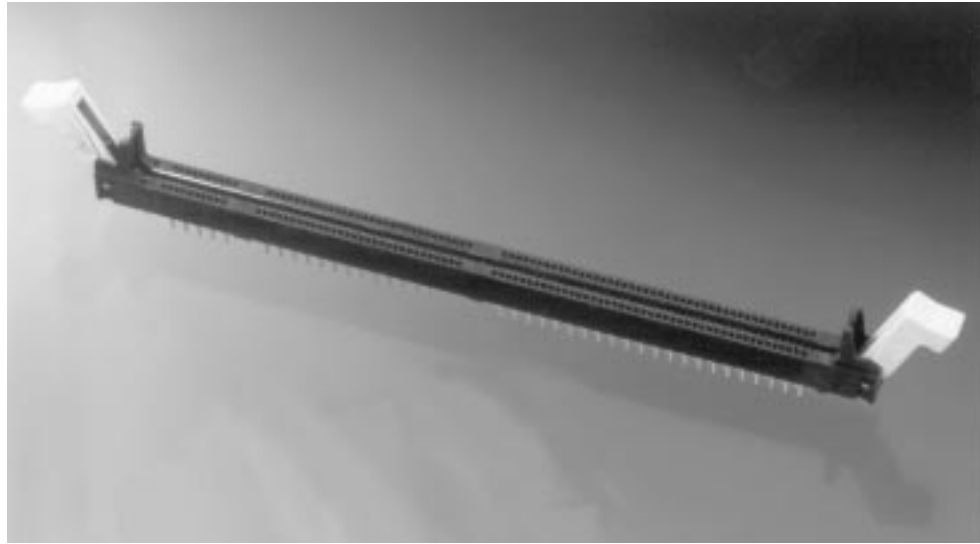

Available from Tyco Electronics is a family of DIMM sockets for 8-Byte DRAM Dual In-Line Memory Module technology.

The two-key¹ sockets are designed for 168-pin modules per JEDEC Standard MO-161. These sockets accept Standard Buffered DRAM, Synchronous DRAM and Non-Standard (Non-Buffered) DRAM modules in 5, 3.3 and future X.X volt versions. Advanced design keying provides damage protection for these various voltages.

The sockets provide twice the density of standard SIMM sockets while staying within present-day 1.27 [.050] centerline technology. In other words, the resultant pin I/O count is the same as if we were able to use 0.64 [.025] centerline spacing. The sockets have been designed to provide highly reliable, low-cost space saving benefits.

These sockets and modules provide increased memory capacity offered by 8 Byte DRAM for a 64-bit data bus. With module memory capacities that range from 2 MBytes to 512 MBytes, this module/socket combination is ideal for today's high end personal computers and work stations.

DIMM IIP (Performance Family) sockets are now available in some versions of 3.3 Volt Std. DRAM and Non-Std. (Non-Buffered) DRAM. See page 5029 for cross reference. For more information contact Tyco Electronics.

¹ A one-key version is also available.

Performance Characteristics:

Current Rating — .5 ampere per contact

Operating Temperature — -55°C to +105°C

Termination Resistance (Dry Circuit) — 20 milliohms max., initial

Dielectric Withstanding Voltage — 1.0 KVAC

Insulation Resistance — 10,000 megohms min., initial

Durability — 25 cycles min.

Mating Force — 4 oz. [1.112 N] max. per contact, initial

Technical Documents:

Product Specification
108-1582

Application Specification
114-1107

For complete product information, order Catalog 1307767

Courtesy of Steven Engineering, Inc. • 230 Ryan Way, South San Francisco, CA, 94080-6370 • Main Office: (650) 588-9200 • Outside Local Area: (800) 258-9200 • www.stevenengineering.com

168 Positions — JEDEC MO-161

(Top view dimensions are the same for all variations.)

Base Part Numbers

390074
390168

See table below showing complete part numbers.

Base Part Numbers

390215
390240

See table below showing complete part numbers.

Material and Finish

Housing & Ejector— High temperature thermoplastic
Contact — Phosphor bronze with gold flash over 0.00051 [.000020] min. thick palladium-nickel over 0.00127 [.000050] min. thick nickel in contact area or 0.00381 [.000150] min. thick tin-lead over 0.00127 [.000050] min. thick nickel in solder area.

Module Keying Details

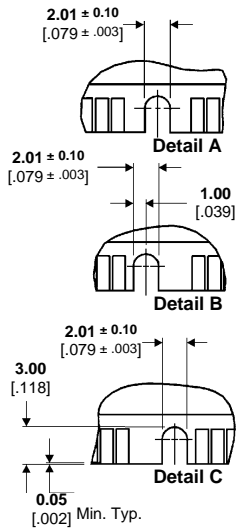

Vertical Dual Read-Out for 8 Byte Memory Modules

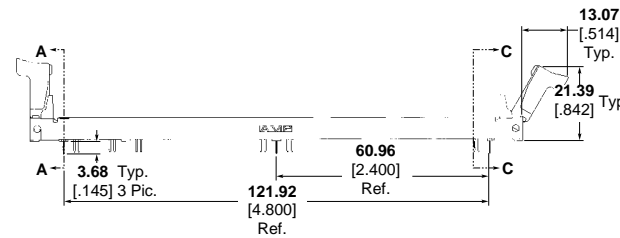
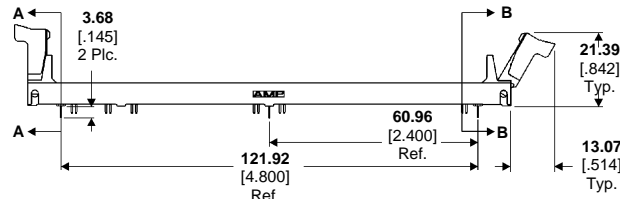
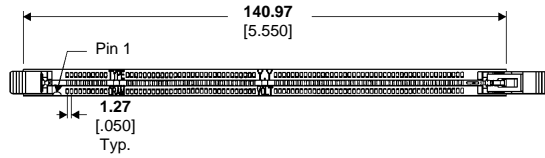

Cross Sections

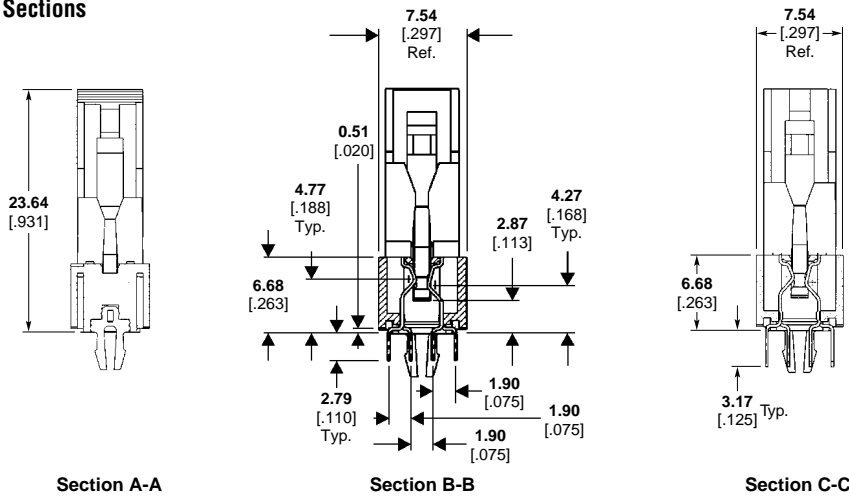

Part Numbers		
Std. DRAM	Sync. DRAM	Non-Std. (Non-Buffered) DRAM
3.3 Volt	3.3 Volt	3.3 Volt
Key 1 = A Key 2 = A	Key 1 = B Key 2 = A	Key 1 = C Key 2 = A
390074-4 ¹	390074-5	390074-6 ¹
390215-4 ¹	390215-5 ¹	390215-6 ¹
390040-4 ²	390040-5 ²	390040-6 ²

Note: ¹ DIMM IIP (Performance Family) product available as replacement for these part numbers. See cross reference. Consult Tyco Electronics for additional information.
² Has plastic retention posts in place of metal boardlocks.

Cross Reference — Standard to DIMM IIP Sockets

Standard	DIMM IIP
390074-4	390168-4
390074-6	390168-1
390215-4	390240-4
390215-6	390240-1

For complete product information, order Catalog 1307767

Right Angle Dual Read-Out for 8 Byte Memory Modules
Product Facts

- Low profile design
- Three profile heights
- Standard and reverse footprints
- Three solder tail length options
- 3.3 volts

Material and Finish

Housing — High Temperature Nylon

Contact — Phosphor Bronze

Contact area — .0000003
 [0.0000076] min. thick gold flash over
 .000020 [0.00051] min. thick palladium
 nickel over .000050 [0.00127] min.
 thick nickel

Solder tail — .000150 [0.0038] min.
 thick tin lead over .00064 [0.0163] min.
 thick nickel

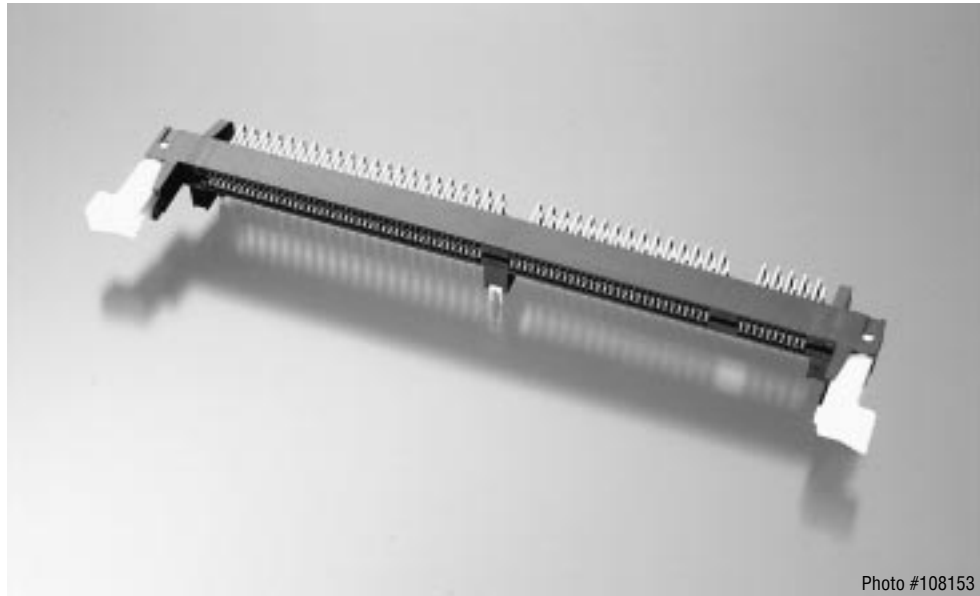

Photo #108153

These 168 position sockets are designed to connect the DIMM II module, which is made to JEDEC specification MO-161, to the motherboard. It accepts an 8 byte

DRAM DIMM module in 64 bit data bus applications. The 1.27mm [.050] pitch style accommodates a module printed circuit board thickness of 1.27mm [.050].

Electrical Characteristics:

Voltage Rating — 30 VAC max.

Current — .5 amp max.

Operating Temperature Range —
 -55° to +105°C

Dielectric Withstanding Voltage —
 1000 VAC

Contact Resistance — 30 milliohms
 max.

Technical Documents:

Product Specification
 108-1756

Application Specification
 114-1119

For complete product information, order Catalog 1307767

Right Angle Dual Read-Out for 8 Byte Memory Modules

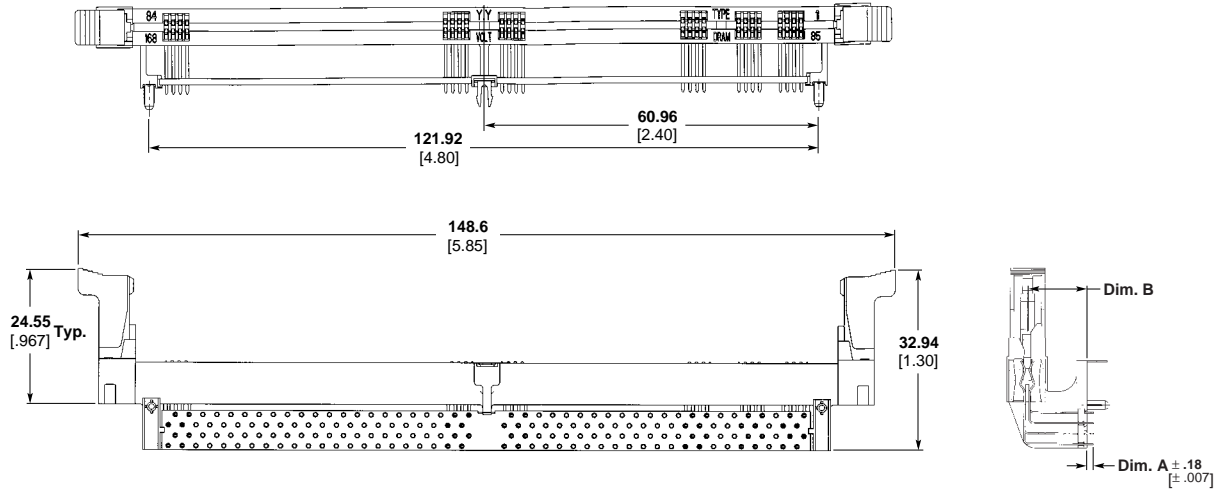



DRAM Type	Footprint	Tail Length (Dim. A)	Housing Height (Dim. B)	Part Number
Standard DRAM (buffered)	Standard, with center barb	3.18 .125	10.92 .430	390175-4
	Standard, with center barb	1.96 .077	9.27 .365	1-390175-4
	Standard, with center barb	2.84 .112	7.11 .280	2-390175-4
	Reverse, with center barb	3.18 .125	10.92 .430	1-390171-4
	Standard, without center barb	1.96 .077	9.27 .365	390172-4
	Standard, without center barb	2.84 .112	9.27 .365	1-390172-4
Sync DRAM	Standard, with center barb	3.18 .125	10.92 .430	390175-5
	Standard, with center barb	1.96 .077	9.27 .365	1-390175-5
	Standard, with center barb	2.84 .112	7.11 .280	2-390175-5
	Reverse, with center barb	3.18 .125	10.92 .430	1-390171-5
	Standard, without center barb	1.96 .077	9.27 .365	390172-5
	Standard, without center barb	2.84 .112	9.27 .365	1-390172-5
NB DRAM (non-buffered)	Standard, with center barb	3.18 .125	10.92 .430	390175-6
	Standard, with center barb	1.96 .077	9.27 .365	1-390175-6
	Standard, with center barb	2.84 .112	7.11 .280	2-390175-6
	Reverse, with center barb	3.18 .125	10.92 .430	1-390171-6
	Standard, without center barb	1.96 .077	9.27 .365	390172-6
	Standard, without center barb	2.84 .112	9.27 .365	1-390172-6

For complete product information, order Catalog 1307767

25° Angular

Product Facts

- Low profile design
- Metal board hold-downs
- Accommodates EDO DRAM and SDRAM modules
- 3.3 volts
- Applicable to PC-100 & PC-133 modules
- Recognized under the Component Program of Underwriters Laboratories Inc., File E28476 
- Certified by Canadian Standards Association File No. LR 7189 

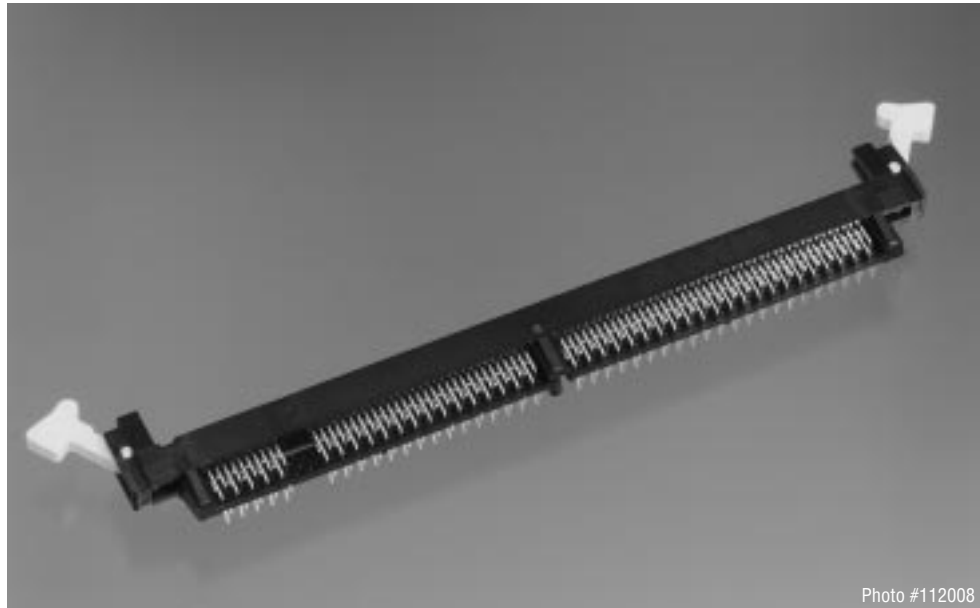

Photo #112008

Material and Finish:

Housing and Ejector — High Temperature Nylon
Contact — Phosphor Bronze
Contact area — .000003 [0.000076] min. thick gold flash over .000020 [0.00051] min. thick palladium nickel over .000050 [0.00127] min. thick nickel
Solder tail — .000150 [0.0038] min. thick tin lead over .000025 [0.00064] min. thick nickel

Technical Documents:

Product Specification
108-1801

Application Specification
114-1118

These 168 position sockets are designed to connect EDO DRAM and SDRAM modules to the motherboard. The connector allows the module to be

slanted at 25° from the motherboard, thereby lowering the total vertical dimension. Plastic alignment posts allow for easy insertion and

improved stability during module insertion, while metal hold-downs eliminate bowing. Positive locking extractors accommodate larger modules.

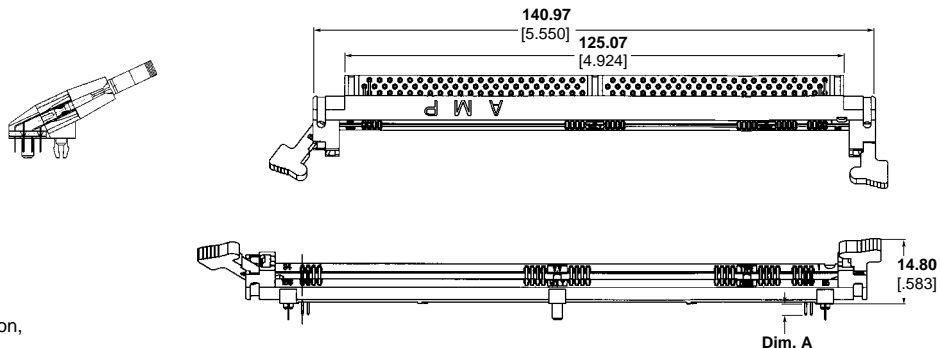

DRAM Type	Tail Length (Dim. A)	Part Numbers	
		Center Plastic Post	Center Metal Board Lock
Standard DRAM (buffered)	2.62 .103	390170-4	390195-4
	3.18 .125	390185-4	—
Sync DRAM	2.62 .103	390170-5	390195-5
	3.18 .125	390185-5	—
NB DRAM (non-buffered)	2.62 .103	390170-6	390195-6
	3.18 .125	390185-6	—

For vertical DIMM IIP sockets, see page 5029.



For complete product information, order Catalog 1307767

Product Facts

- Low profile — only 4.6 [.181] max. * for high density pc board stacking
- Compatible footprint allows for socket or direct mounting
- Housing slots accept extraction tool for easy PLCC removal
- Corner chamfer for PLCC orientation
- Available loose piece or tape mounted
- Plastic standoffs provide clearance for heat dissipation and cleaning operations
- Housings will withstand high temperature soldering
- Open bottom housing for convenient placement of socket on pattern, 100% inspection of solder joint, and penetration of heat source to the solder pad and surface mount contact
- Top contact slots allow test probing with PLCC device in place
- Recognized under the Component Program of Underwriters Laboratories Inc., File No. E28476 
- Certified by Canadian Standards Association File LR 7189A-97 

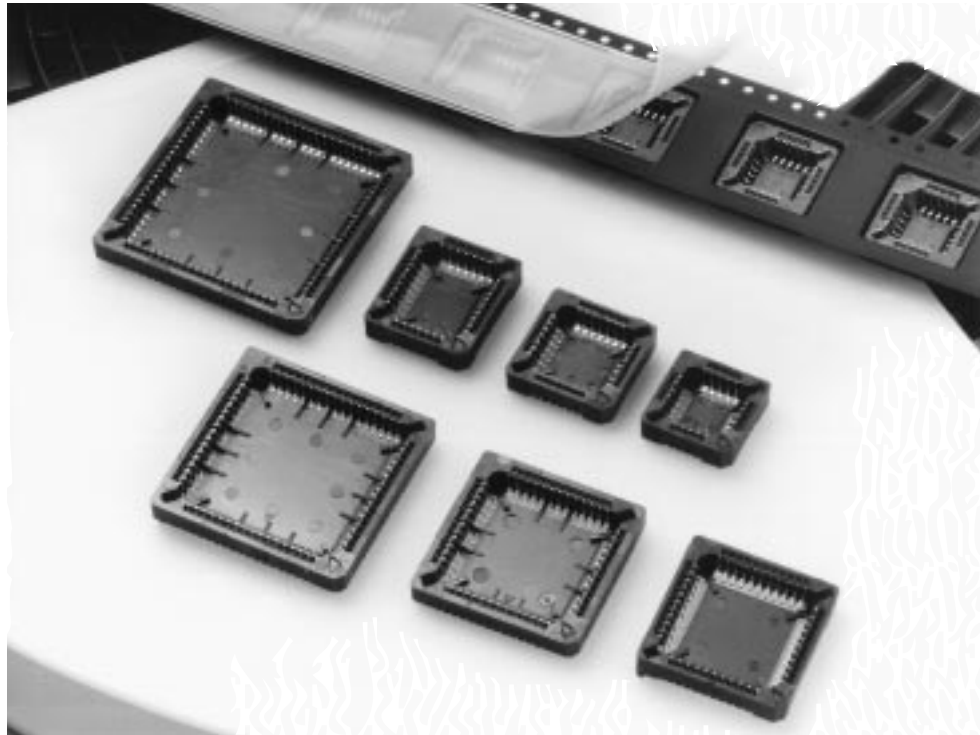

The AMP family of Low Profile Plastic Leaded Chip Carrier (PLCC) Sockets for surface mounting is designed to accommodate Plastic "J" leaded, tin plated devices made to JEDEC Specifications MS-018 (square packages) and MS-016-AE (rectangular packages).

Available in 20, 28, 32, 44, 52, 68 and 84 positions, these sockets feature high normal force contacts made from phosphor bronze material with tin-lead over nickel plating. Sockets feature a one-piece housing that will withstand vapor-phase, I.R. or convection reflow soldering temperatures and prevent flux and solvent entrapment.

The low profile housing is only 4.6 [.181] high, maximum* allowing high density printed circuit board stacking. The open bottom design enables easy socket placement on the pc board footprint pattern facilitates inspection as well as permitting the heat source to penetrate to the solder pad and surface mount contact. The socket uses the same footprint pattern as the chip carrier.

Sockets are also available on embossed tape made to EIA Standard 481 which allows interchangeability of tape in commercially available pick-and-place equipment.

For complete product information, order Catalog 1307767

Small Outline Low Profile, Surface Mount

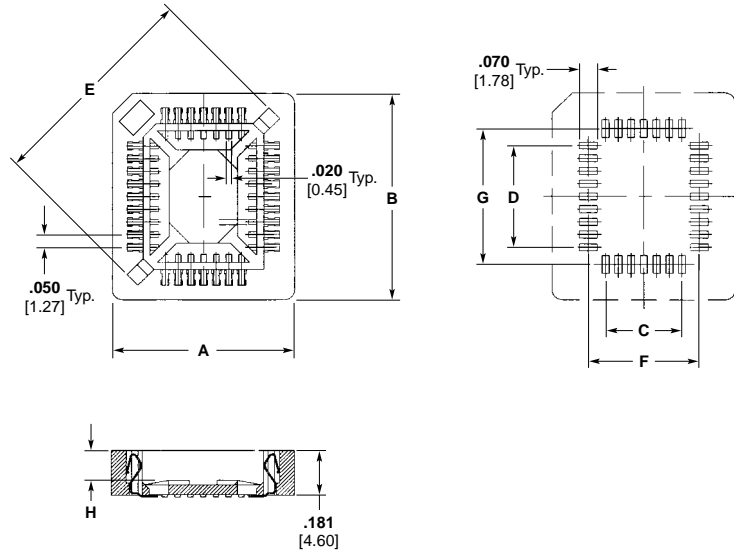

Number of positions	Dimensions								Tube		Tape/Reel		
	A	B	C	D	E	F	G	H	Part Number	Quantity per Carton	Part Number	Size Tape	Quantity per Carton
20	.364 14.36	.364 14.36	.200 5.08	.200 5.08	.645 16.38	.334 8.48	.334 8.48	.108 2.75	822499-3	8,580	3-822499-3	24mm	5,000
28	.664 16.90	.664 16.90	.300 7.62	.300 7.62	.790 20.00	.434 11.02	.434 11.02	.108 2.75	822499-2	7,260	3-822499-2	24mm	4,000
32	.664 16.90	.767 19.50	.300 7.62	.400 10.16	.861 21.89	.434 11.02	.534 13.56	.102 2.60	822498-1	6,380	3-822498-1	32mm	4,000
44	.866 22.00	.866 22.00	.500 12.70	.500 12.70	1.07 27.20	.634 16.10	.634 16.10	.116 2.95	822499-1	4,160	3-822499-1	44mm	2,100

WITHDRAWAL TOOL FOR PLCC'S

The PCS Series Extraction Tool is designed for the removal of JEDEC dimensioned "J" leaded 4-sided plastic leaded chip carrier with leads on .050" (12,7) centers. A "Universal" tool, it is compatible with most competitor's PLCC sockets.



TX 8136-20/84 PCS

FEATURES:

- Fits all sizes : 20 thru 84 positions
- Positive engagement and tool action assures smooth, level extraction of device
- Spring assisted release of device from tool after extraction

OPERATION:

1. Holding tool between thumb and 1st or 2nd finger at ribbed area of legs. Expand or contract legs to engage tongs in extraction slots of socket.
2. Push tool down to insure legs seat flush with the top of the socket. This will assure extraction tongs are properly positioned under device.
3. Squeeze legs between thumb and finger. Tool action will extract device in smooth positive motion.
4. Relaxing pressure on legs releases device from tool.

For complete product information, order Catalog 1307767

Industry Standard Low Profile, Surface Mount

Materials and Finish

Housing — Thermoplastic, UL 94V-0 rated

Contacts — Phosphor bronze with 0.00254 [.000100] 90/10 Tin-lead over 0.00127 [.000050] min. nickel all over

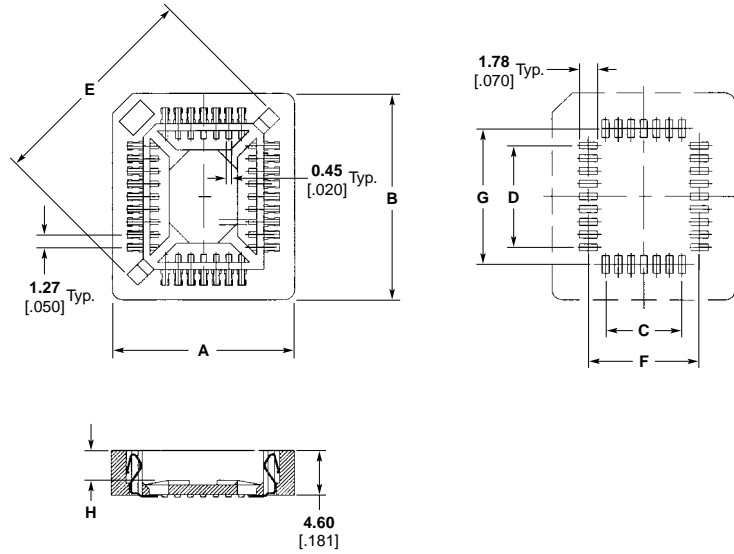

No. of Pos.	Dimensions								Tube		Tape/Reel		
	A	B	C	D	E	F	G	H	Part No.	Quantity Per Carton	Part No.	Size Tape	Quantity Per Carton
20	15.58 .613	15.58 .613	5.08 .200	5.08 .200	16.38 .645	8.48 .334	8.48 .334	2.75 .108	822472-1	11700	3-822472-1	24mm	5000
28	18.12 .713	18.12 .713	7.62 .300	7.62 .300	20.00 .790	11.02 .434	11.02 .434	2.75 .108	822472-2	9900	4-822472-2	32mm	4000
32	18.12 .713	20.66 .813	7.62 .300	10.16 .400	21.89 .861	11.02 .434	13.56 .534	2.60 .102	822472-3	8700	3-822472-3	32mm	4000
44	23.20 .913	23.20 .913	12.70 .500	12.70 .500	27.20 1.07	16.10 .634	16.10 .634	2.90 .114	822472-4	6240	3-822472-4	44mm	2100
52	25.74 1.01	25.74 1.01	15.24 .600	15.24 .600	30.78 1.21	18.64 .734	18.64 .734	2.75 .108	822472-5	3220	3-822472-5	44mm	2100
68	30.82 1.21	30.82 1.21	20.32 .800	20.32 .800	37.98 1.50	23.72 .934	23.72 .934	2.90 .114	822472-6	3420	3-822472-6	44mm	1800
84	35.90 1.41	35.90 1.41	25.40 1.00	25.40 1.00	45.20 1.78	28.80 1.13	28.80 1.13	2.90 .114	822472-7	2346	3-822472-7	56mm	1000

For complete product information, order Catalog 1307767

Thru-Hole

PCS Series



PCS-068A-1

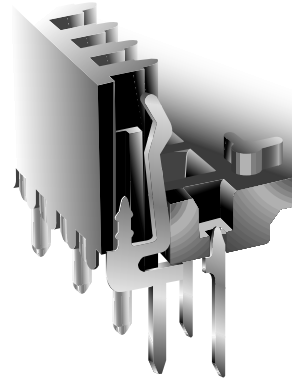

FEATURES:

The PCS Series Chip Carrier sockets accepts Jeduc Type "A" plastic leaded chip carriers on .050" (1.27) centers. These dependable sockets combine positive retention of the package with high normal force to insure outstanding electrical and mechanical performance. The solder tail design allows through-hole board patterns on .100" (2.54) grid.

- High Normal force, 200 grams (7.1 oz.) min.
- Internal standoff insures proper positioning of chip carrier in socket
- Visual aids external to socket assure easy registration to printed wiring board
- Easy access for probing installed chip carrier
- Standoffs and four drain holes aid in cleaning
- PLCC Extraction Tool TX8136-20/84 PCS, see page 5034
- Accepts JEDEC PLCC's MO-047 AA-AH (20-84), MO-052 AE (32 RECT)
-  Recognized under the Component Program of Underwriters Laboratories, Inc. file no. E111362

MATERIAL SPECIFICATIONS:

Insulator.....PPS, UL rated 94V-0
 ContactPhosphor bronze
 PlatingTin/lead

PERFORMANCE SPECIFICATIONS:

MECHANICAL

VibrationPassed MIL-STD-1344, Method 2005.1, Condition II, 10 G's
 Shock.....Passed MIL-STD-1344, Method 2004.1, Condition A, 50 G's
 Durability50 Cycles minimum
 Normal Force200 Grams (7.1 oz.) minimum when mated to nominal size PLCC device
 Mating Force310 Grams (11.0 oz.) per line maximum when mated to maximum size PLCC device
 Unmating Force.....31 Grams (1.1 oz) per line minimum when mated to minimum size PLCC device
 SolderabilityPassed MIL-STD-202, Method 208
 Contact Retention in Plastic2.0 Lbs. per line minimum

ELECTRICAL

Contact Resistance30 Milliohms max.
 Contact Rating.....1 Amp
 Capacitance1 pF max. @ 1 kHz, MIL-STD-202, Method 305 (contact to contact)
 Insulation Resistance.....1 x 10⁴ Megohms per MIL-STD-1344, Method 3003.1
 Dielectric Withstanding Voltage600 VAC per MIL-STD-1344, Method 3001.1

ENVIRONMENTAL

HumidityPassed MIL-STD-1344, Method 1002.2, Type II
 Operation Temperature-55°C to +105°C

For complete product information, order Catalog 1308409

Thru-Hole

PCS Series

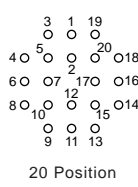

20 Position

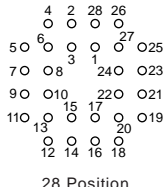

28 Position

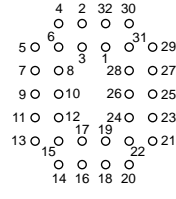

32 Position

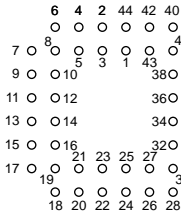

44 Position

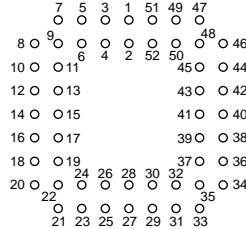

52 Position

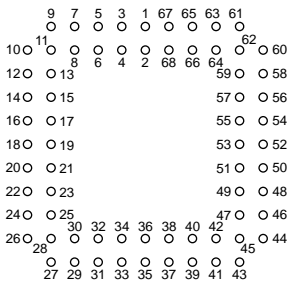

68 Position

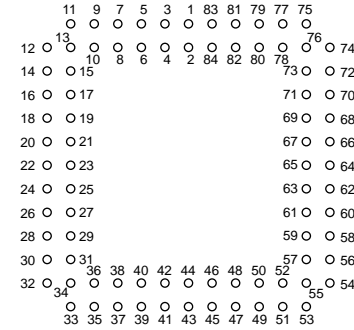

84 Position

Recommended Hole Layout
Viewed from the Top of Socket
Tolerance ±.002 Unless Otherwise Noted

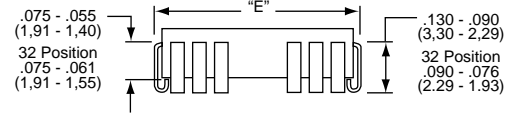
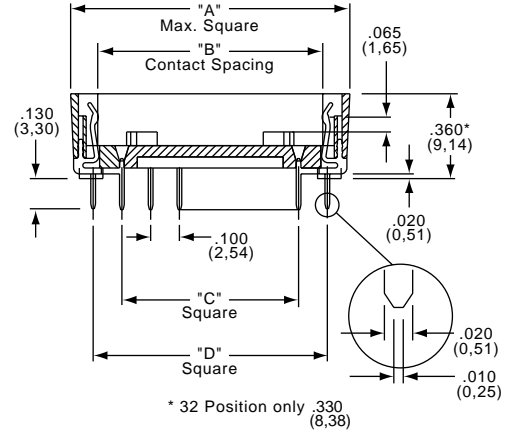
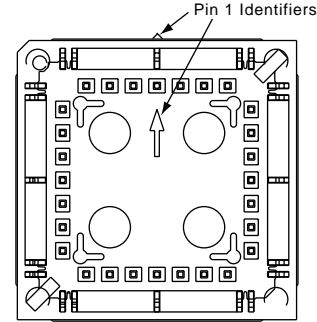
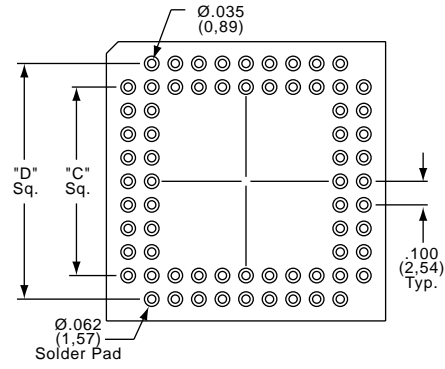

STANDARD CONFIGURATIONS

Part Number	Number of Contacts	A	B*	C	D	E
PCS-020A-1	20	.590 (14,98)	.360 (9,14)	.200 (5,08)	.400 (10,16)	.395/.385 (10,03/9,78)
PCS-028A-1	28	.690 (17,52)	.460 (11,68)	.300 (7,62)	.500 (12,70)	.495/.485 (12,57/12,32)
PCS-044A-1	44	.890 (22,60)	.660 (16,76)	.500 (12,70)	.700 (17,78)	.695/.685 (17,65/17,40)
PCS-052A-1	52	.990 (25,15)	.760 (19,30)	.600 (15,24)	.800 (20,32)	.795/.785 (20,19/19,94)
PCS-068A-1	68	1.190 (30,22)	.960 (24,46)	.800 (20,32)	1.000 (25,40)	.995/.985 (25,27/25,02)
PCS-084A-1	84	1.390 (35,31)	1.160 (29,54)	1.000 (25,40)	1.200 (30,48)	1.195/1.185 (30,35/30,10)

* Dimension B ± .010 (0,25)

32 POSITION RECTANGULAR

Part Number	Number of Contacts	A		B*		C		D		E	
		Long Side	Short Side	Long Side	Short Side	Long Side	Short Side	Long Side	Short Side	Long Side	Short Side
PCS-032A-1	32	.790 (20,07)	.690 (17,53)	.564 (14,33)	.464 (11,79)	.400 (10,16)	.300 (7,62)	.600 (15,24)	.500 (12,70)	.595/.585 (15,11/14,86)	.495/.485 (12,57/12,32)

* Dimension B ± .010 (0,25)

For complete product information, order Catalog 1308409

Note: Before ordering, see Cross Reference in Section 15 for equivalent Tyco Electronics Part Number.

Thru-Hole, Economy

Material and Finish:

Housing — Thermoplastic UL94V-0

Contacts — Phosphor bronze with tin-lead over nickel

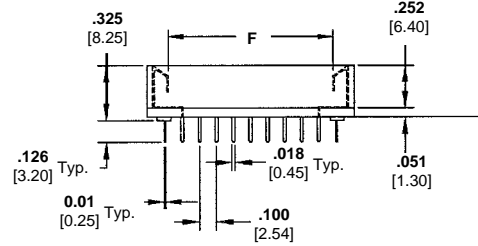
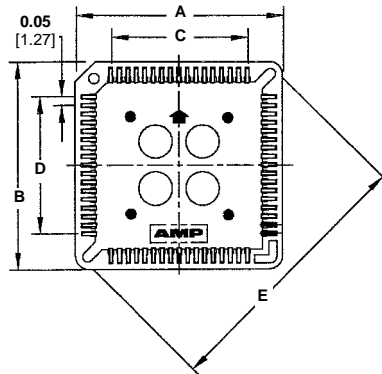

Positions	Dimensions						Part Numbers
	A	B	C	D	E	F	
20	0.62 15.56	0.62 15.56	0.20 5.08	0.20 5.08	0.68 17.20	0.35 8.90	822473-1
28	0.71 18.10	0.71 18.10	0.30 7.62	0.30 7.62	0.82 20.70	0.45 11.46	822473-2
32	0.71 18.10	0.81 20.54	0.30 7.62	0.40 10.16	0.90 22.65	0.45 11.36	822473-3
44	0.92 23.18	0.92 23.18	0.50 12.70	0.50 12.70	1.08 27.50	0.66 16.74	822473-4
52	1.01 25.72	1.01 25.72	0.60 15.24	0.60 15.24	1.24 31.50	0.76 19.30	822473-5
68	1.21 30.80	1.21 30.80	0.80 20.32	0.80 20.32	1.54 39.00	0.96 24.38	822473-6
84	1.41 35.88	1.41 35.88	1.00 25.40	1.00 25.40	1.82 46.15	1.16 29.42	822473-7

For complete product information, order Catalog 1308409

Standard

Product Facts

- .025 [0.64] centerline for high density, low cost packaging
- Low profile permits even higher density packaging with only .375 [9.53] maximum height pc boards
- High normal force and positive engagement allows for reliable service to minimize field failures
- Protective cover separates and safeguards IC leads during handling and insertion
- Closed-bottom housing aids in prevention of solder bridging between contacts
- Contacts absorb mating and reaction forces for board and housing protection
- Economical design makes socketing of semi-conductor devices more attractive
- .020 [0.51] minimum wipe contact insures reliability of tin-to-tin interface
- High temperature materials
- Sockets can be spaced a minimum of .150 [3.81] from each other

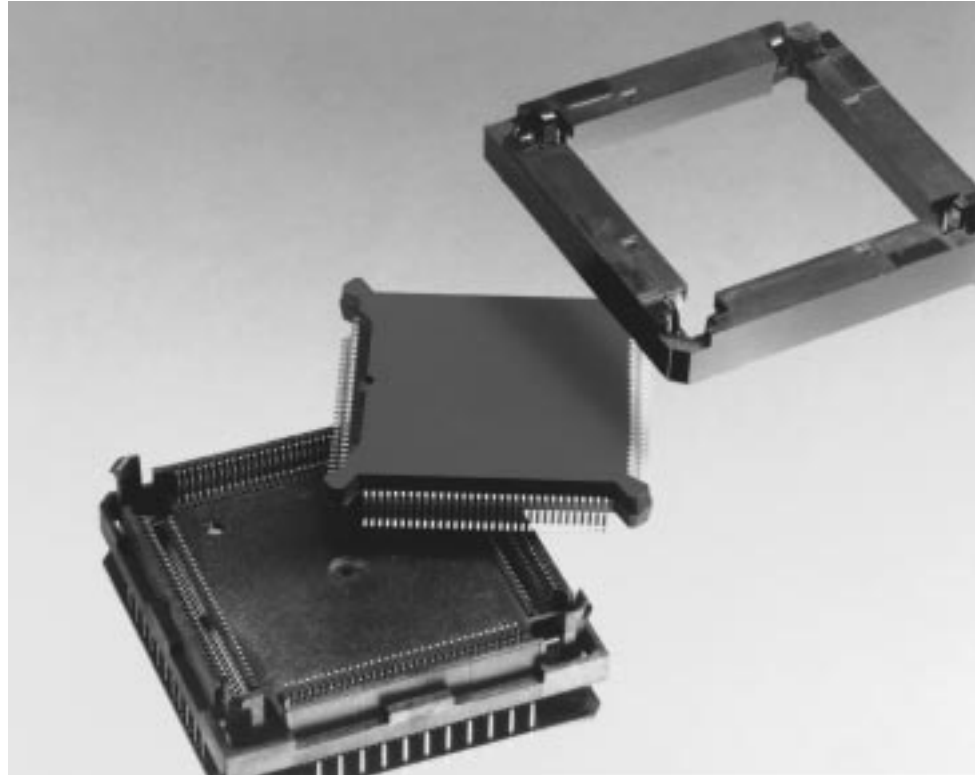

The two-piece design of the AMP socket eases the problems of handling the gullwing-leaded PQFP packages. The IC is first inserted into the plastic cover and then, using the insertion tool, the cover is secured over the socket housing to insert the chip into the socket. The completed assembly presents a low .375 [9.53] profile to permit close stacking of pc boards.

The cover, which is separately available, contains slots that not only protect and separate the leads, but also for proper lead-to-contact registration between chip and socket. In addition, the cover provides a rugged cost-effective method of protecting the PQFP IC during shipping, handling and assembly. Visual and mechanical polarization for proper orientation of cover and housing during mating,

while spring latches in the four corners secure the cover to the housing.

Tin plated socket contacts provide a minimum .020 [0.51] wipe and exert a high normal force to the IC leads. The solder legs are arranged on a .075 x .100 [1.91 x 2.54] three-row grid to permit easy trace routing.

High-temperature housing materials and a sealed bottom allow the socket to withstand the rigors of flow soldering lines and other automated assembly. Standoffs ease flux cleaning.

Available in 100- and 132-position sizes, the socket features short leads and low capacitance, making it highly compatible with high-speed circuits.

Performance Characteristics:

Current Rating — 1 ampere max.

Operating Temperature — +55°C to +105°C

Dielectric Withstanding Voltage — 750 VAC min.

Capacitance (Adjacent Contacts) — 1 picofarad max.

Durability — 15 insertion/withdrawal cycles

Technical Documents:

Product Specification
108-1223

Application Specification
114-1070

Test Report
501-90

Instruction Sheets
408-3289 Hand Tools
408-9772 Pneumatic Tools

Standard

Materials and Finish:

Housing — High temperature thermoplastic, 94V-0 rated, black

Cover — Polyphenylene sulfide (PPS), 94V-0 rated, black

Contacts — Phosphor bronze with .000200 [0.00508] tin over .000050 [0.00127] nickel

Insertion Hand Tools

100 Position

Part Number 822253-1

132 Position

Part Number 822253-2



Extraction Tool

Part Number 822254-1

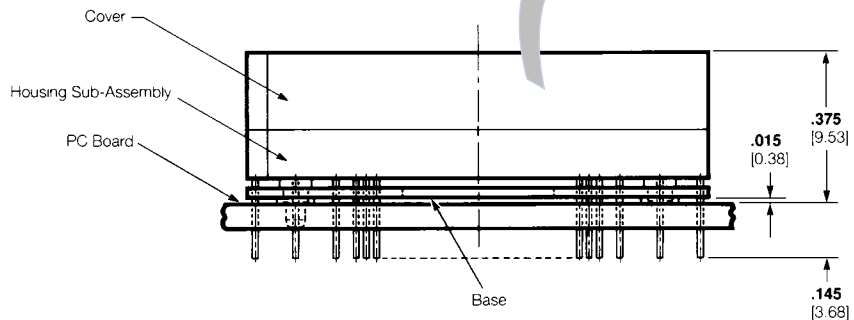
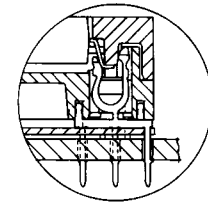
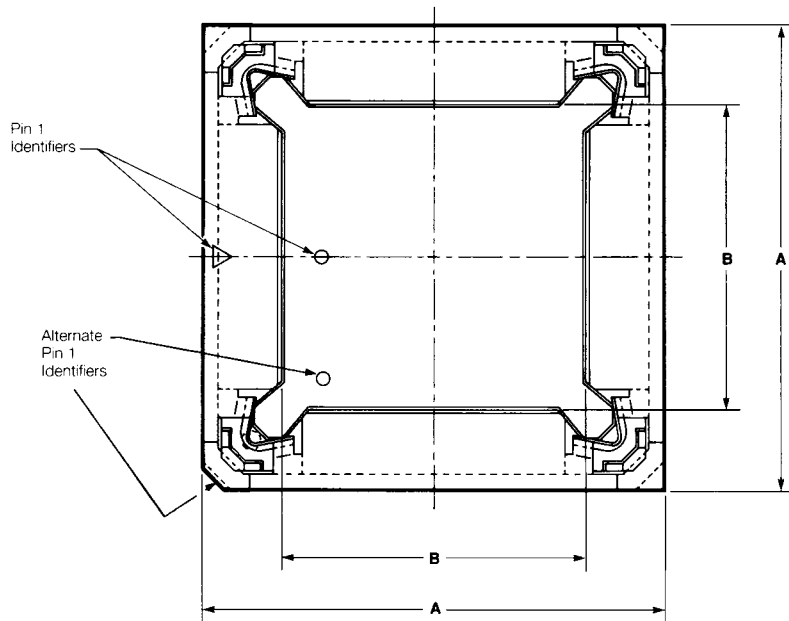

No. of Positions	Dimensions		Conventional AMP Sockets	Replacement for 3M TEXTOL sockets	
	A	B	Housing Sub-Assembly	Housing Sub-Assembly	Cover
100	1.140 28.96	.750 19.05	821949-4 ¹	822064-4 ²	821939-1
132	1.340 34.04	.950 24.13	821949-5 ¹	822064-5	821942-1

¹ Conventional footprint.

² Reverse footprint.

Packaging Quantities:

100 Position — 19 Pcs./Tube, 54 Tubes/Box, Total = 1026 Pcs./Box

132 Position — 16 Pcs./Tube, 45 Tubes/Box, Total = 720 Pcs./Box

Metric

JEDEC (EIAJ) Metric Quad Flat Pack ICs
Product Facts

- Closed bottom design prevents solder wicking and bridging
- Standoffs facilitate flushing of solder fluxes from under socket
- Horizontal normal force reduces the stress on latches
- Contact wiping removes oxides from package leads
- High pressure tin contacts provide high normal force for interface reliability
- Molded separation ribs for contact to lead alignment
- Components molded of high temperature materials
- Mechanical and visual polarization allows pin #1 alignment
- Cover provides means for handling and testing bumperless packages
- Cover secures device for handling regardless of corner configuration
- Socket design is not sensitive to package stand-off dimension
- Socketing eases prototype evaluation
- Socketing provides reparability in the field
- Socketing enables equipment configuration at the manufacturing level
- Socketing minimizes device damage problems due to SMT temperatures
- Socketing allows field updating
- Socketing utilizes conventional through-hole soldering processes
- Socket design is compatible with robotic assembly

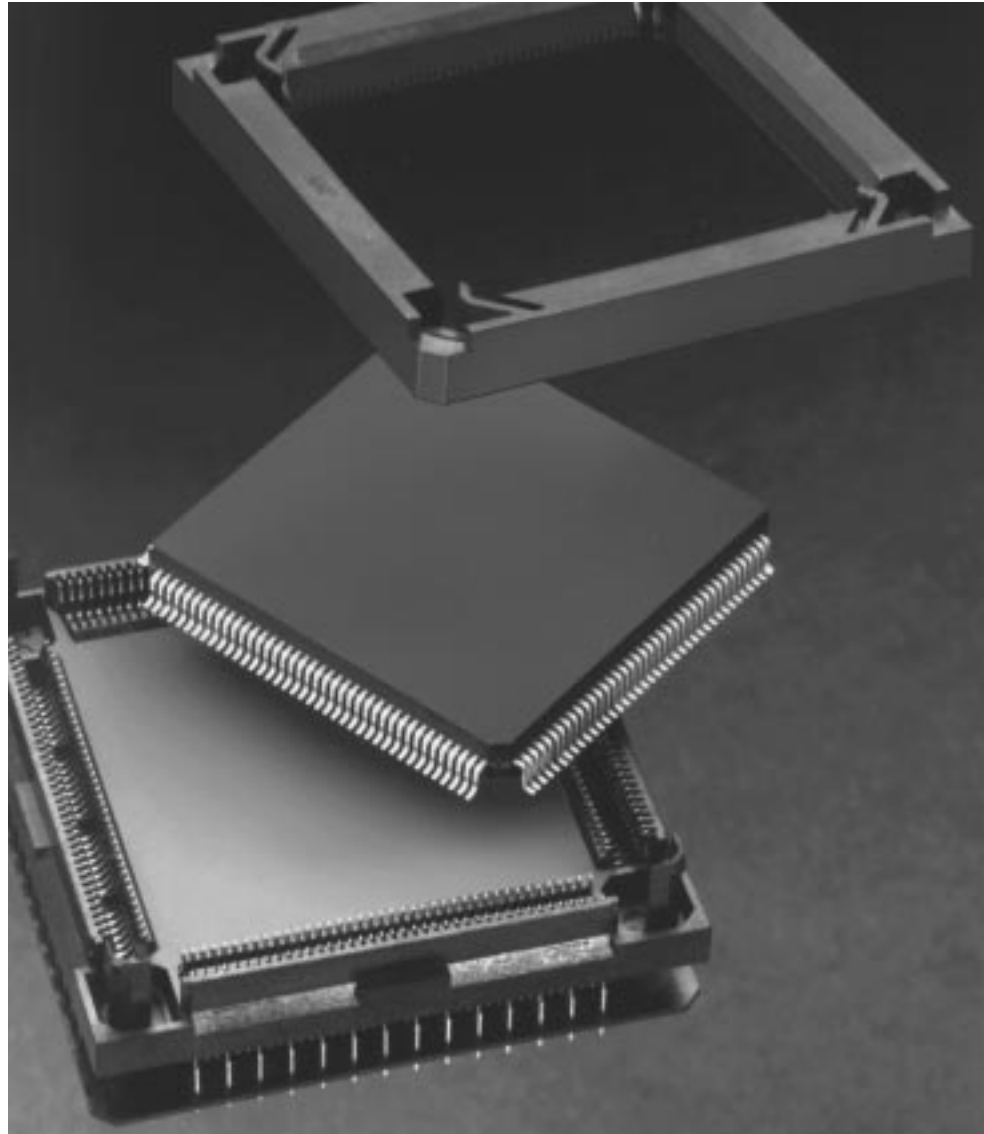

The AMP Metric PQFP socket provides a method for through-hole socketing of JEDEC (EIAJ) bumperless metric quad flat pack devices. The socket is designed to accept PQFP-style 28mm x 28mm packages on .65mm spacing per proposed JEDEC (EIAJ) Standard MO-108.

The socket features a two-piece design that allows the device to be first inserted into the plastic cover. Then the cover with the device is secured over the socket

housing using the AMP insertion tool. This system protects the delicate gullwing leads and ensures proper lead-to-contact registration.

Available in 144- and 160-position versions, the socket features high temperature housing materials and a sealed bottom allowing it to withstand the rigors of flow soldering lines and automated assembly.

Technical Documents:
Product Specification

108-1348

Application Specification

114-1070

Instruction Sheets

408-3289 Hand Tools

408-9772 Pneumatic Tool

Metric

For JEDEC Metric Quad Flat Pack ICs

Materials and Finish:

Housing and Cover — High temperature thermoplastic, 94V-0 rated

Contacts — Phosphor bronze with 0.00508 [.000200] tin-lead over 0.00127 [.000050] nickel

Performance Characteristics:

Voltage Rating — 250 VAC

Termination Resistance, Dry Circuit — 20 milliohms max, initial

Dielectric Withstanding Voltage — 750 VAC

Insulation Resistance — 5000 megohms

Capacitance — 1 picofarad max.

Durability — 15 cycles

Mating Force — 2.22 N [.5 lb.] max.

Contact Retention — 3.34 N [12 oz.]

Physical Shock — 50 Gs

Vibration — 15 Gs

Temperature Rating — 255°C to 1105°C

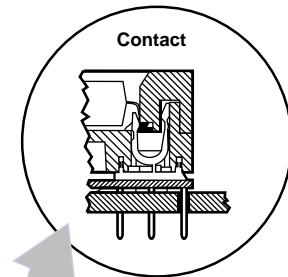
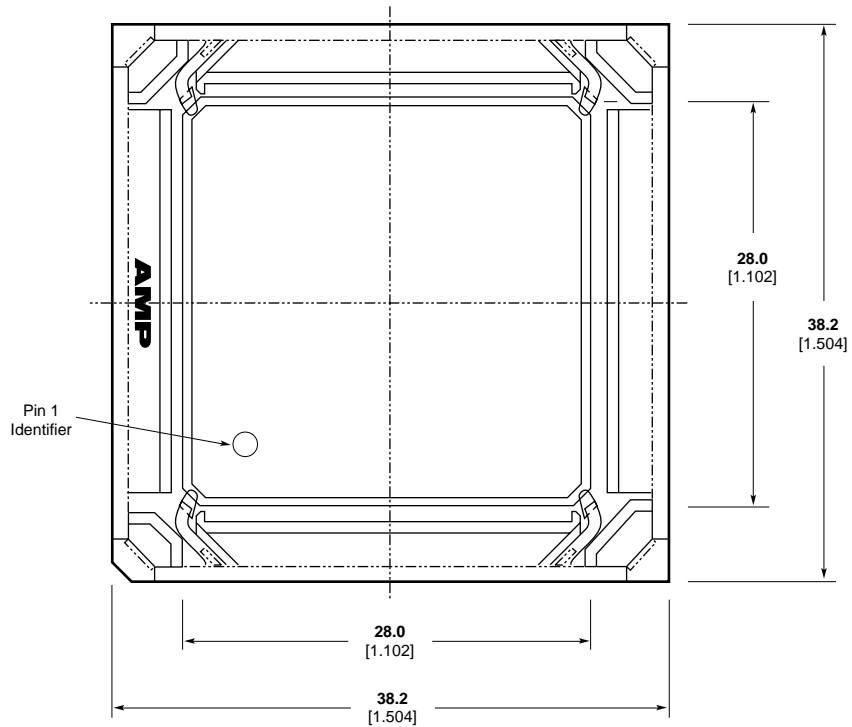

Insertion Hand Tool



Part Number 822253-4

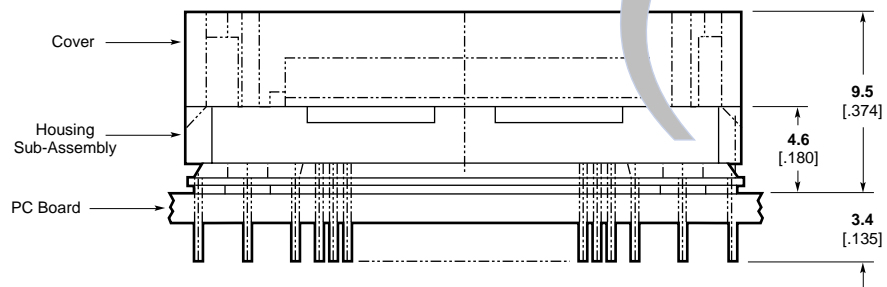

Extraction Tool



Part Number 822254-1

No. of Positions	Part Numbers	
	Housing Sub-Assembly	Cover
144	822114-3	822115-3
160	822114-4	822115-4

Packaging Quantities:

Cover shipped separately in antistatic tubes, 14 pcs./tube
Housing Assembly shipped in antistatic tubes, 14 pcs./tube

HOLTITE Series Press-Fit Sockets, Zero Profile



HOLTITE 8134-HC-5P3 Sockets

FEATURES:

The solderless zero-profile HOLTITE Socket contact is designed to be press-fit into the plated-thru hole of a printed wiring board. This unique design allows the plated-thru hole to become the component socket. The outer conical shape of the HOLTITE Socket contact sizes the plated-thru hole when pressed into place. The precision-machined geometry allows for the controlled displacement of plated material without damaging the hole, or affecting the normal mechanical and electrical contact performance.

- **Lowest socket profile**
The profile of the printed wiring board with the HOLTITE Socket contact installed is less than the length of the IC or component lead, offering the lowest socketing profile, permitting card rack spacing as low as .400", identical to that of direct soldering.
- **Precision-machined, tapered-entry, four finger contact**
The underlying contact design used in the HOLTITE Socket system has a proven record of reliability after more than fifteen years' usage in both commercial and military applications.
- **Retains minimum component lead lengths**
The socketing technique provides the shortest distance between the component seating plane and the contact engagement zone for maximum retention of short component leads.
- **Maximum heat dissipation**
Open contact design permits air flow through the board, increasing heat dissipation and extending component life.
- **Solderless, gas-tight, press-fit insertion**
The solderless, pluggable system saves the time and cost of soldering, plus minimizing the potential for heat damage, warpage and corrosive residue contamination.
- **Removes artwork design restrictions**
Use of the HOLTITE Socket solderless system removes certain artwork restrictions necessary for wave soldering and solder joint construction. Line spacing can be made as tight as electrical parameters allow without solder bridging or the need for soldermask. Terminal areas can be reduced in diameter without the need of a base for solder fillets. Ground plane areas can be increased without concern for heat-induced warpage.
- **Immediate conversion to the HOLTITE Socket system**
Existing printed wiring designs can be converted by simply changing the drilled hole diameter prior to plating.

MATERIAL SPECIFICATIONS:

Carrier Strip.....MYLAR
 ContactBeryllium copper
 Finish.....Gold or tin/lead plated

PERFORMANCE SPECIFICATIONS: 5P HOLTITE SOCKETS

MECHANICAL

VibrationPassed MIL-STD-202, Method 204, 20 G's
 DurabilityPassed MIL-STD-1344, Method 2016, 50 cycles
 Insertion Force92 Grams (3.2 oz.) average with a .018" polished steel pin and a .043" plated thru hole
 Withdrawal Force103 Grams (3.6 oz.) average with a .018" polished steel pin and a .043" plated thru hole
 Contact Retention in Board 5 Lb. minimum

ELECTRICAL

Contact Resistance10 Milliohms max.
 Contact Rating.....3 Amps

ENVIRONMENTAL

HumidityPassed MIL-STD-202, Method 106
 Thermal ShockPassed MIL-STD-202, Method 107, Cond. F
 Operation Temp.Gold contact -55°C to +125°C,
 Tin/lead contact -55°C to +105°C

For performance specifications on 6P, 8P and 12P HOLTITE Sockets, please consult Tyco Electronics.



HOLTITE Series Press-Fit Sockets, Zero Profile

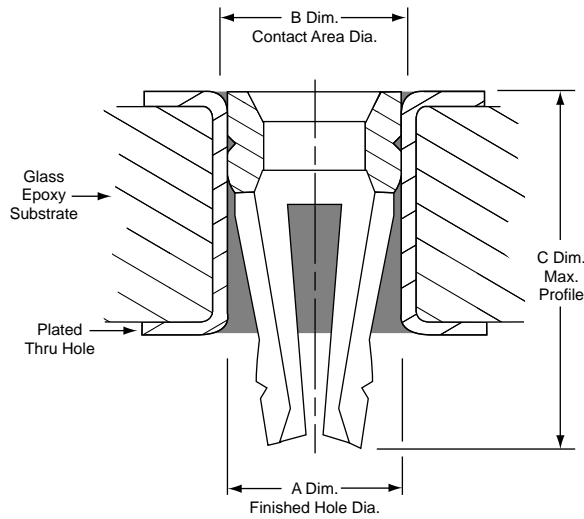

TABLE 1: PART NUMBERS

Military Part Number	Augat Part Number
M83505/6-001	M8134-HC-5P2
M83505/6-002	M8134-HC-6P2
M83505/6-003	M8134-HC-8P2
M83505/6-004	M8134-HC-12P2

RECOMMENDED HOLE SIZE AND LEAD SIZE

Part Number	Recommended Lead Size	Recommended Primary Drill Size	A Dim. Finished Plated-Thru Hole Size	B Dim. Contact Diameter	C Dim. Maximum Profile	Board Thickness	Plated-Thru Hole Finish
8134-HC-5P2 (Gold)	Rectangular Lead .011 x .018 (±.002) (0,28 x 0,46) (±0,05)	.0453 (1,15)	.041 ± .002 (1,04 ± 0,05)	.044 ± .0005 (1,12 ± 0,01)	.100 (2,54)	.030 (0,75) Minimum	.0003 - .0005 (0,0076 - 0,0127) Electro-deposited Tin/Lead over .001 (0,0254) Minimum Thick Electro Deposited Copper Plate
8134-HC-5P3 (Tin/Lead)	or Round Lead .016 - .021 (0,406 - 0,533) Diameter						
8134-HC-6P2 (Gold)	Round Lead .020 - .030 (0,51 - 0,76) Diameter	.0635 (1,61)	.058 ± .002 (1,47 ± 0,05)	.0625 ± .0005 (1,59 ± 0,01)	.140 (3,56)		
8134-HC-6P3 (Tin/Lead)	Round Lead .025 - .035 (0,64 - 0,89) Diameter						
8134-HC-8P2 (Gold)	Also suitable for use with .025 sq. post	.0875 (2,22)	.082 ± .002 (2,08 ± 0,05)	.0860 ± .0005 (2,18 ± 0,01)	.160 (4,06)	.050 (1,27) Minimum	
8134-HC-8P3 (Tin/Lead)	Round Lead .035 - .045 (0,89 - 1,14) Diameter						
8134-HC-12P2 (Gold)	Round Lead .035 - .045 (0,89 - 1,14) Diameter	.0875 (2,22)	.082 ± .002 (2,08 ± 0,05)	.0860 ± .0005 (2,18 ± 0,01)	.160 (4,06)	.050 (1,27) Minimum	
8134-HC-12P3 (Tin/Lead)	Round Lead .035 - .045 (0,89 - 1,14) Diameter						

Oversized Holtite

When recommended plated thru hole size has been exceeded by .002 (0,05) or less:
Part Numbers: 8134-HC-14P2 for 5P2; 8134-HC-14P3 for 5P3.

Gold Holtite Bulk Package are available qualified to MIL-S-83505.

See Table 1 for part numbers.

Note: Before ordering, see Cross Reference in Section 15 for equivalent Tyco Electronics Part Number.

HOLTITE Series Press-Fit Sockets, Zero Profile, on Reel



322-HCS5P2-100

HOLTITE SOCKET SIP PATTERN REELS

Part Number	Contact Plating	Number of Contacts per Pattern	Contact Style	Part Number	Contact Plating	Number of Contacts per Pattern	Contact Style
322-HCS5P2-100	Gold	2500 Contacts per Reel	5P2	322-HCS8P2-100	Gold	2500 Contacts per Reel	8P2
322-HCS5P3-100	Tin/Lead		5P3	322-HCS8P3-100	Tin/Lead		8P3
322-HCS6P2-100	Gold		6P2	322-HCS14P2-100*	Gold		14P2
322-HCS6P3-100	Tin/Lead		6P3	322-HCS14P3-100*	Tin/Lead		14P3

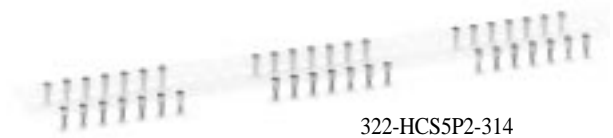

322-HCS5P2-314

HOLTITE SOCKET DIP PATTERN REELS

Part Number	Contact Plating	Number of Contacts per Pattern	Number of Patterns per Reel	Row Spacing	Contact Style	Contacts per Reel
322-HCS5P2-300	Gold	Universal on .100"	—	.300"	5P Series	5000
322-HCS5P3-300	Tin/Lead					
322-HCS5P2-308	Gold	8 Positions on .100"	625			
322-HCS5P3-308	Tin/Lead					
322-HCS5P2-314	Gold	14 Positions on .100"	357			
322-HCS5P3-314	Tin/Lead					
322-HCS5P2-316	Gold	16 Positions on .100"	313			
322-HCS5P3-316	Tin/Lead					
322-HCS5P2-318	Gold	18 Positions on .100"	278			
322-HCS5P3-318	Tin/Lead					
322-HCS5P2-320	Gold	20 Positions on .100"	250			
322-HCS5P3-320	Tin/Lead					
322-HCS5P2-400	Gold	Universal on .100"	—	.400"	5P Series	5000
322-HCS5P3-400	Tin/Lead					
322-HCS5P2-422	Gold	22 Positions on .100"	227			
322-HCS5P3-422	Tin/Lead					
322-HCS5P2-424	Gold				24 Positions on .100"	208
322-HCS5P3-424	Tin/Lead					
322-HCS5P2-600	Gold	Universal on .100"	—	.600"	5P Series	5000
322-HCS5P3-600	Tin/Lead					
322-HCS5P2-624	Gold	24 Positions on .100"	208			
322-HCS5P3-624	Tin/Lead					
322-HCS5P2-628	Gold	28 Positions on .100"	179			
322-HCS5P3-628	Tin/Lead					
322-HCS5P2-632	Gold	32 Positions on .100"	156			
322-HCS5P3-632	Tin/Lead					
322-HCS5P2-636	Gold	36 Positions on .100"	139			
322-HCS5P3-636	Tin/Lead					
322-HCS5P2-640	Gold	40 Positions on .100"	125			
322-HCS5P3-640	Tin/Lead					

Application notes and tooling information appear on page 5046 & 5047.

Note: Before ordering, see Cross Reference in Section 15 for equivalent Tyco Electronics Part Number.

HOLTITE Socket Application Notes

OVERVIEW

The AMP HOLTITE Socket contact is a solderless, zero-profile contact designed to be contained within the barrel of a plated-thru hole. The unique design allows the contact and the plated-thru hole to form a zero-profile component socket which provides both the normal forces and the low contact resistance required to mechanically retain and electrically interconnect a broad range of electronic parts and components.

The outer shape of the HOLTITE Socket contact allows the plated-thru hole to elastically conform during insertion. The precision machined geometry allows for the controlled deformation of plated material without damaging the plated-thru hole or affecting the normal electrical and mechanical contact performance.

MATERIALS AND DESIGN

HOLTITE Socket contacts are precision machined from double-drawn solid beryllium-copper wire, and then heat treated. Beryllium copper is used because of its spring properties after heat treating. The copper affords excellent conductivity, while the beryllium lends hardness and durability to the finished contact.

The HOLTITE Socket contact has been machined as a seamless heat treated part, which gives it more uniform and repeatable spring properties than those of a stamped contact used in an identical through hole diameter. This uniformity of normal forces minimizes variations in contact resistance and is designed for the proper insertion/withdrawal forces on mating parts.

The HOLTITE Socket contact has been designed to provide a solderless gas tight electrical connection with mating parts. The angled contact opening greatly facilitates lead entry (especially important when automatically inserting IC's), and reduces the possibility of lead or plating damage. Two locking collars provide contact retention through a controlled elastic deformation, and a machined groove between the collars provides a relief for the compressive radial forces of the plated-thru hole plating material. Concentration of the forces and elastic deformation in this manner locks the contact in place.

A transition region below the lower collar serves as a relief area for any plastic deformation of plating material that may occur as the contact is inserted into the plated-thru hole. This relief provides the consistency of contact normal forces over slight variations in hole size, because plated-thru hole walls (under prescribed plating tolerances) will not come into contact with the beam of the HOLTITE Socket fingers.

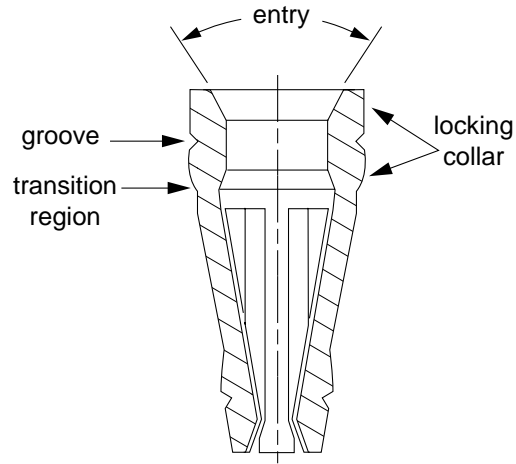

Figure 4
Profile Cross-Section

HOLE REQUIREMENTS

The fingers of 5P series HOLTITE Socket contacts will protrude out of circuit boards that are less than 3/32" (2,38 mm) thick. Care in board handling should be exercised in this case to prevent damage to the exposed contact fingers. This is not a concern in board thicknesses of 3/32" or greater because the contact fingers are entirely contained within the plated-thru hole.

The press fit technology used for installing HOLTITE Socket contacts is directly dependent on the hole size tolerance. The tolerances of the primary and finished hole sizes in a printed circuit board must be sufficiently narrow for adequate compressive stress between the hole walls and the locking collars of the contact.

The primary (drilled) hole size is a very important dimension. Finished hole tolerances should NOT be maintained by drilling over-sized holes and then plating down to the correct size, because copper and tin/lead alone will not create the compressive forces necessary to retain the HOLTITE Socket contact over time and temperature ranges. Drilling undersized holes, on the other hand, may introduce problems such as excessive contact insertion forces, board warpage and crazing around the hole. Holes should be drilled from the component insertion side of the board, whenever possible, to avoid creating drill-exit burrs on the press-fit portion of the thru-hole.

HOLTITE Socket Application Notes

SOCKET ASSEMBLY AND TOOLING

A HOLTITE Socket is created in the circuit board by inserting a Holtite contact directly into a plated-thru hole. The selective loading of contacts into plated-thru holes defines the socket outline. There are several alternatives for loading contacts into a plated-thru hole, ranging from "one at a time" hand loading tools available from Tyco Electronics to a simple flat press.

HOLTITE SOCKET PRINTED WIRING CONTACT KIT

Part Number 398-HK-001 (Gold HOLTITE Sockets) and 398-HK-002 (Tin/Lead HOLTITE Sockets)

This "starter" kit is primarily designed to allow the loading of HOLTITE Socket contacts into a limited number of prototype boards as well as random individual loading into production boards.

The kit consists of: 5P Series and 6P Series HOLTITE Socket contacts, combination insertion tool and NO-GO gages for each, and a spring-loaded seating tool. The two insertion tools are color coded. The red end of each tool is NO-GO gage used for "quick check" hole size inspection. The insertion portion of the tools is designed to remove HOLTITE Socket contacts from their carrier cards and selectively insert them into plated-thru holes. Individual pressing and seating is then accomplished with the spring-loaded seating tools.

Quantities of approximately 1,000 5P and 2000 6P Series HOLTITE Socket contacts are supplied on cards with .100" grid spacing.



398-HK-001 (Gold HOLTITE Sockets)

or

398-HK-002 (Tin/Lead HOLTITE Sockets)

Note: Before ordering, see Cross Reference in Section 15 for equivalent Tyco Electronics Part Number.

SPRING LOADED HAND TOOL



399-HT-114

HOLTITE SOCKET TIPS

Tip # 399-HT-112 is for use with 5P HOLTITE Sockets and is blue in color.

Tip #399-HT-113 is for use with 6P, 8P, & 12P HOLTITE Sockets and is white in color.



399-HT-112

399-HT-113

PNEUMATIC HAND TOOL SYSTEM

This is a pneumatically operated system designed to individually seat Holtite contacts after they have been inserted into plated-thru holes. The system consists of a small control box connected by pneumatic tubing to a hand held impact tool. The tip of the hand tool is inserted into the contact and impact button is depressed. The contact is accurately seated into plated-thru hole. Pressure adjustments of the control box and variable tip sizes on the hand tool, allow this system to work with any size HOLTITE Sockets contact.

This system is particularly useful when loading random contacts, and is designed for low-volume production. The contact seating method provided by this system works very well in conjunction with HOLTITE Sockets contacts packaged on mylar carrier strips. The contacts, in this case remain secured in the MYLAR carrier until they have been seated in the plated-thru hole. The mylar carrier, at that point can be removed and discarded.

Holtite contacts in mylar are most commonly packaged on reels in the form of continuous strips. Custom socket patterns can be produced to satisfy individual customer requirements.



736-M0020

Plug Adapter Assemblies

600 Series

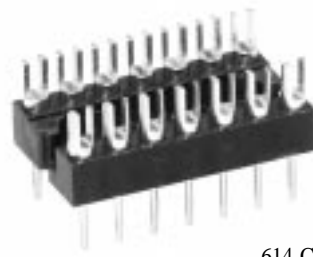

614-CG1

FEATURES:

The 600 Series is a high quality machined pin molded adaptor which is used to assemble hybrid and special network circuits. The .018" (0,46) diameter precision pin allows the adaptor to be plugged into socket or wire wrappable panels repeatedly.

- Precision machined pins
- Used for interposing discrete components
- Terminals are the same dimension as IC board patterns
- Option of round, solder pocket or slotted pin styles
- Thermoplastic polyester insulators
- Large variety of styles:
 - 8, 14, 16, 20 pins - .300" (7,62) between rows
 - 22 pins - .400" (10,16) between rows
 - 14, 16, 24, 28, 32, 36, and 40 pins - .600" (15,24) between rows
 - 14 & 16 pins - .800" (20,32) between rows

MATERIAL SPECIFICATIONS:

InsulatorThermoplastic polyester, UL rated 94V-0
 PinsPhospher bronze, gold or tin/lead plated

Note: Before ordering, see Cross Reference in Section 15 for equivalent Tyco Electronics Part Number.

PERFORMANCE SPECIFICATIONS:

MECHANICAL

VibrationTested to a frequency range of 10 to 2,000 Hz and returned to 10Hz in three perpendicular planes at a double amplitude of .06" (1,52) or 20 G's, whichever was less per MIL-STD-202, Method 204

Mechanical Shock.....Will meet the requirements of MIL-STD-202, Method 213 when subjected to a shock test at 150 G's acceleration

ELECTRICAL

Current Rating.....5 Amps when tested with a 30-gauge wire attached. Terminal will have a maximum 30°C temperature rise above ambient

CapacitanceAt a test frequency of 1 KHz, adjacent and/or terminal all at guard potential

Adjacent terminal:
 AG and CG solder tail.....36pF
 BG (solder pocket)42pF

Opposite Terminal:
 AG and CG solder tail.....025pF
 BG (solder pocket)034pF

Dielectric Withstanding ..

Voltage1,000 VRMS @ 30 inches mercury, .500 VRMS when tested @ 0.9 inches mercury, tested per MIL-STD-202, Method 301

Insulation Resistance1 x 10¹² Ohms, tested to MIL-STD 202, Method 302, tested @ 500 Volts

ENVIRONMENTAL

Thermal Shock.....No visual damage when tested in accordance with MIL-STD-202, Method 107, test condition F for 5 consecutive cycles of -65°C to +150°C

Operating Temperatures.....-65°C to +125°C

Salt SprayNo visual evidence of corrosion on Gold terminals when tested per MIL-STD-202, Method 101 Test condition B for 48 hours and a 5% salt solution

Courtesy of Steven Engineering, Inc. • 230 Ryan Way, South San Francisco, CA, 94080-6370 • Main Office: (650) 588-9200 • Outside Local Area: (800) 258-9200 • www.stevenengineering.com

Plug Adapter Assemblies

600 Series

STANDARD CONFIGURATIONS

Number of Pins	Pin Style	Gold Part Number	Tin Part Number	"A" Max.	"B" Typ.	"C" *	"D ₁ " **	"D ₂ " **	"D ₃ " **	Figure
8	Round	608-AG1	608-AG1T	.400 (10,16)	.300 (7,62)	.300 (7,62)	—	—	—	1A
	Solder Pocket	608-BG1	608-BG1T							1B
	Slotted	608-CG1	608-CG1T							1C
14	Round	614-AG1	614-AG1T	.700 (17,78)	.600 (15,24)	.300 (7,62)	—	—	—	1A
	Solder Pocket	614-BG1	614-BG1T							1B
	Slotted	614-CG1	614-CG1T							1C
14	Round	614-AG3	614-AG3T	.700 (17,78)	.600 (15,24)	.600 (15,24)	.400 (10,16)	—	—	2A
	Solder Pocket	614-BG3	614-BG3T							2B
	Slotted	614-CG3	614-CG3T							2C
14	Round	614-AG2	614-AG2T	.750 (19,05)	.600 (15,24)	.800 (20,32)	—	—	—	3A
	Solder Pocket	614-BG2	614-BG2T							3B
	Slotted	614-CG2	614-CG2T							3C
16	Round	616-AG1	616-AG1T	.800 (20,32)	.700 (17,78)	.300 (7,62)	—	—	—	1A
	Solder Pocket	616-BG1	616-BG1T							1B
	Slotted	616-CG1	616-CG1T							1C
16	Round	616-AG3	616-AG3T	.800 (20,32)	.700 (17,78)	.600 (15,24)	.400 (10,16)	—	—	2A
	Solder Pocket	616-BG3	616-BG3T							2B
	Slotted	616-CG3	616-CG3T							2C
16	Round	616-AG2	616-AG2T	.850 (21,59)	.700 (17,78)	.800 (20,32)	—	—	—	3A
	Solder Pocket	616-BG2	616-BG2T							3B
	Slotted	616-CG2	616-CG2T							3C
18	Round	618-AG1	618-AG1T	.900 (22,86)	.800 (20,32)	.300 (7,62)	—	—	—	1A
	Solder Pocket	618-BG1	618-BG1T							1B
	Slotted	618-CG1	618-CG1T							1C
20	Round	620-AG1	620-AG1T	1.000 (25,90)	.900 (22,86)	.300 (7,62)	—	—	—	1A
	Solder Pocket	620-BG1	620-BG1T							1B
	Slotted	620-CG1	620-CG1T							1C
22	Round	622-AG1	622-AG1T	1.150 (29,21)	1.000 (25,90)	.400 (10,16)	—	—	—	1A
	Solder Pocket	622-BG1	622-BG1T							1B
	Slotted	622-CG1	622-CG1T							1C
24	Round	624-AG1	624-AG1T	1.200 (30,98)	1.100 (27,94)	.600 (15,24)	.900 (22,86)	.400 (10,16)	—	2A
	Solder Pocket	624-BG1	624-BG1T							2B
	Slotted	624-CG1	624-CG1T							2C
28	Round	628-AG2	628-AG2T	1.400 (35,56)	1.300 (33,02)	.600 (15,24)	.900 (22,86)	.400 (10,16)	—	2A
	Solder Pocket	628-BG2	628-BG2T							2B
	Slotted	628-CG2	628-CG2T							2C
32	Round	632-AG2	632-AG2T	1.600 (40,64)	1.500 (38,10)	.600 (15,24)	.900 (22,86)	.400 (10,16)	—	2A
	Solder Pocket	632-BG2	632-BG2T							2B
	Slotted	632-CG2	632-CG2T							2C
36	Round	636-AG1	636-AG1T	1.800 (45,72)	1.700 (43,18)	.600 (15,24)	1.500 (38,10)	.900 (22,86)	.400 (10,16)	2A
	Solder Pocket	636-BG1	636-BG1T							2B
	Slotted	636-CG1	636-CG1T							2C
40	Round	640-AG1	640-AG1T	2.000 (50,80)	1.900 (48,26)	.600 (15,24)	1.500 (38,10)	.900 (22,86)	.400 (10,16)	2A
	Solder Pocket	640-BG1	640-BG1T							2B
	Slotted	640-CG1	640-CG1T							2C

* Dimension C ± .010 (0,25)

** Dimension D₁, D₂, D₃ ± .005 (0,13)

Solderless Wrap Styles:

3 Level Solderless Wrap: add "F" to printed circuit Part Number. Ex. 608-AG1TF

Note: Before ordering, see Cross Reference in Section 15 for equivalent Tyco Electronics Part Number.

5
Sockets

Plug Adapter Assemblies

600 Series

SOLDER STYLE TERMINALS

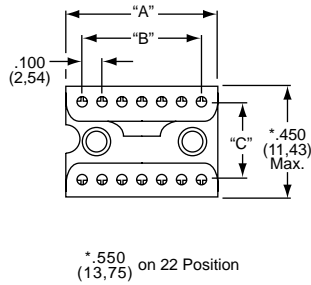

Fig. 1

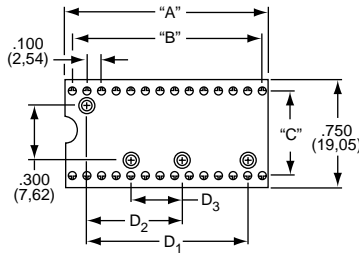

Fig. 2

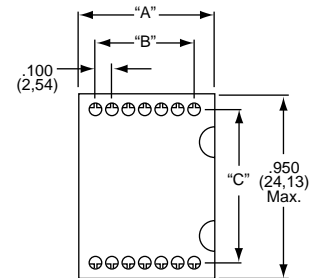

Fig. 3

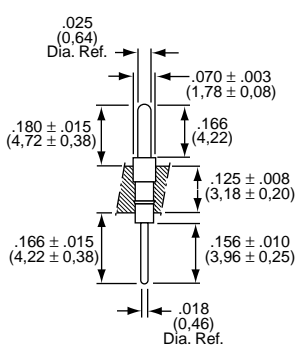

Figure A
8128-41P6 (Gold)

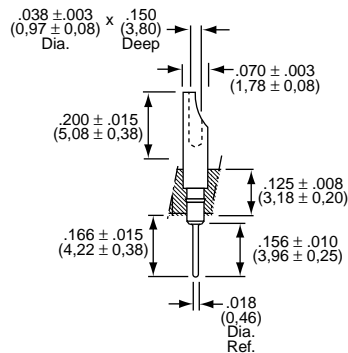

Figure B
8128-40P10 (Gold)

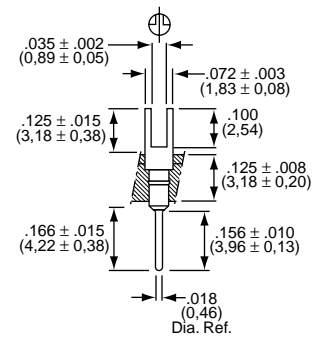
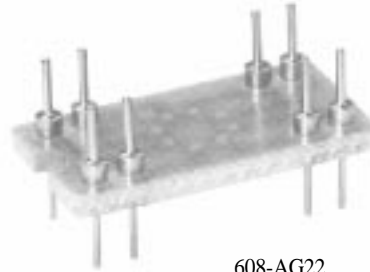

Figure C
8128-39P6 (Gold)

Note: Before ordering, see Cross Reference in Section 15 for equivalent Tyco Electronics Part Number.

Transistor Adapter Plugs

600-AG Series



608-AG22

FEATURES:

The 600-AG family of FR4 glass epoxy machined pin adaptors, converts standard 6 thru 10 lead round style transistor packages to standard 14 and 16 pin I.C. formats. These adaptors are used to mount circuits directly to wire wrappable panels that have 14 or 16 pin sockets, plug directly into DIP sockets or solder directly to printed wiring panels.

- TO-5 adaptors with .300" (7,62) centers between rows of pins, mount directly to any 14 or 16 pin packaging panel
- Feed thru pins/style, for convenient use as test points
- .018" (0,46) Dia. pins for multiple insertion into socket contacts
- .026" (0,66) Dia. mounting holes enable mounting transistor directly or for mounting a transistor socket for greater flexibility
- Adaptors with .600" (15,24) centers designed for use on universal packaging panels
- Traces plated with electro tin for easy soldering

MATERIAL SPECIFICATIONS:

Insulator.....0.062" (1,57) Thick FR4 glass epoxy,
 UL rated 94V-2 or better

PlatingElectro tin

PinPhosphor bronze

PlatingGold

PERFORMANCE SPECIFICATIONS:

MECHANICAL

SolderabilityPassed MIL-STD-202, Method 208

ELECTRICAL

Capacitance4 pF

Bulk Resistance.....10 Milliohms max.

Current Rating.....5 Amps DC per pin

Operating Voltage500 Volts, not to exceed limit
 of interconnected device

Dielectric Withstanding
 Voltage1,000 Volts @ sea level, 300 Volts @ 50,000 feet

Insulation Resistance..... 2×10^7 Ohms

ENVIRONMENTAL

Operating Temperature-50^o C to +125^o C

Note: Before ordering, see Cross Reference in Section 15 for equivalent Tyco Electronics Part Number.



Courtesy of Steven Engineering, Inc. • 230 Ryan Way, South San Francisco, CA, 94080-6370 • Main Office: (650) 588-9200 • Outside Local Area: (800) 258-9200 • www.stevenengineering.com

Transistor Adapter Plugs

600-AG Series

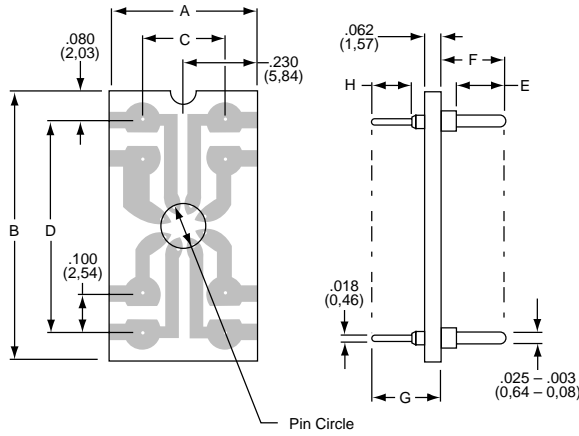

Figure 1
606-AG10
608-AG21
608-AG22

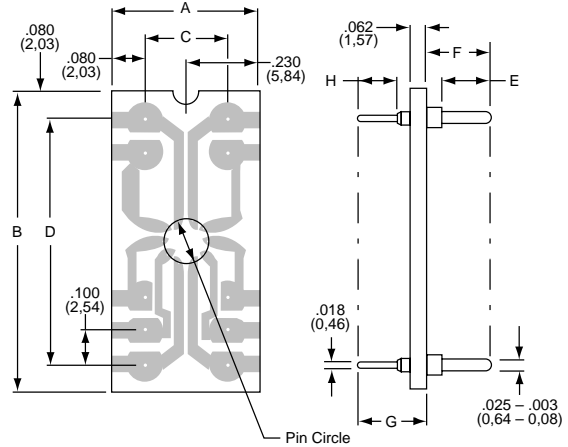

Figure 2
610-AG22

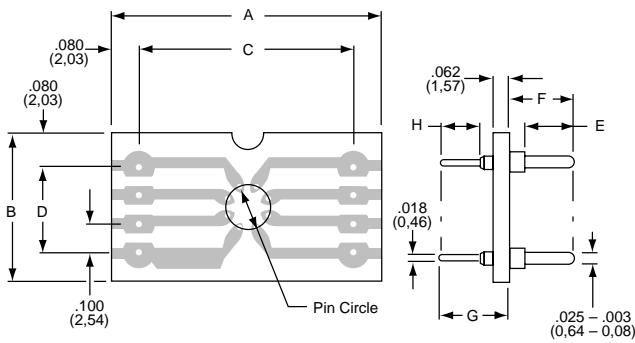

Figure 3
608-AG19

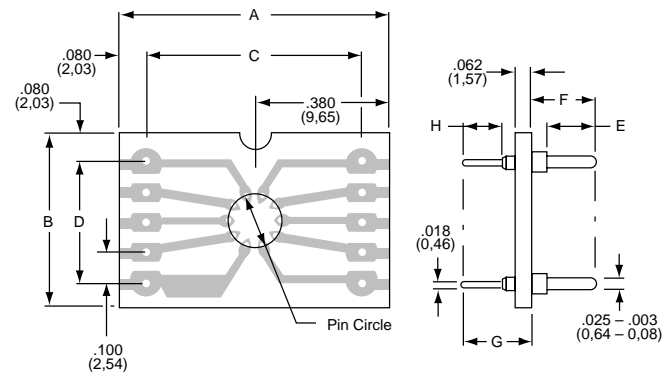

Figure 4
610-AG19

PART NUMBERS / STANDARD CONFIGURATIONS

Part Number	Figure	Pin Count <small>NO PIN POSITIONS 9 & 12</small>	Pin Circle	A *	B *	C **	D Ref.	E **	F ***	G **	H ***
606-AG10	1	6	.200 (5,08)	.460 (11,68)	.860 (21,84)	.300 (7,62)	.700 (17,78)	.166 (4,22)	.218 (5,54)	.259 (6,58)	.156 (3,96)
608-AG19	3	8	.230 (5,84)	.760 (19,30)	.460 (11,68)	.600 (15,24)	.300 (7,62)				
608-AG21	1	8	.200 (5,08)	.460 (11,68)	.860 (21,84)	.300 (7,62)	.700 (17,78)				
608-AG22	1	8	.230 (5,84)	.460 (11,68)	.860 (21,84)	.300 (7,62)	.700 (17,78)				
610-AG19	4	10	.230 (5,84)	.760 (19,30)	.560 (14,20)	.600 (15,24)	.400 (10,16)				
610-AG22	2	10	.230 (5,84)	.460 (11,68)	.860 (21,84)	.300 (7,62)	.700 (17,78)				

* Dimension A, B ± .010

** Dimension C, E, G ± .005

*** Dimension F, H ± .015

Note: Before ordering, see Cross Reference in Section 15 for equivalent Tyco Electronics Part Number.

Numerical Display Sockets

500 Series

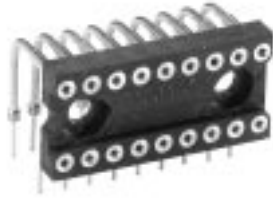

518-AG7D



516-AG21D



508-AG8D

FEATURES:

Offers a wide range of LED and ganged unit sockets to allow for total flexibility and size variations while incorporating the design features of our standard 500 Series sockets.

- Two-piece tapered entry socket terminal — four-fingered, gold plated inner contact and machined tin/lead plated outer sleeve.
- Available in either solderless wrap or printed circuit termination.
- Horizontal or right angle mounting.

MATERIAL SPECIFICATIONS (Figures 1, 2, 3):

Inner ContactFour-fingered beryllium copper, gold
 Outer SleeveMachined brass, tin/lead plated
 Insulator.....Thermoplastic polyester UL rated 94V-0

MATERIAL SPECIFICATIONS (Figure 4):

Inner ContactFour-fingered beryllium copper, gold
 Outer SleeveBrass, tin/lead plated
 BoardGlass epoxy, tin-plated copper circuitry
 TerminalPhosphor bronze, solder-coated
 SpacerDelrin

Note: Before ordering, see Cross Reference in Section 15 for equivalent Tyco Electronics Part Number.

PERFORMANCE SPECIFICATIONS:

MECHANICAL

VibrationPassed MIL-STD-1344, Method 2005.1, Condition II, 10 G's
 Shock.....Passed MIL-STD-1344, Method 2004.1, Condition C, 100 G's
 DurabilityPassed MIL-STD-1344, Method 2016
 Normal Force200 Grams (7.0 oz.) average with .018" (0,46) dia. polished steel pin
 Insertion Force179 Grams (6.3 oz.) average with .018 (0,46)" dia. polished steel pin
 Withdrawal Force63 Grams (2.2 oz.) average with .018" (0,46) dia. polished steel pin
 SolderabilityPassed MIL-STD-202F, Method 208
 Sleeve Retention
 in Plastic3.5 Lbs. per line minimum solderless wrap; 3.0 Lbs. PC tail
 Inner Contact
 Retention7.5 Lbs. per line average

ELECTRICAL

Contact Resistance10 Milliohms
 Contact Rating.....3 Amps
 Capacitance1.0 pF per MIL-STD-202, Method 305 (contact to contact)
 Insulation Resistance.....5,000 Megohms min. @ 500 VDC per MIL-STD-1344, Method 3003.1
 Dielectric Withstanding
 Voltage1,000 Volts RMS per MIL-STD-1344, Method 3001.1

ENVIRONMENTAL

HumidityPassed MIL-STD-1344, Method 1002.2, Cond. II
 Thermal ShockPassed MIL-STD-1344, Method 1003.1, Cond. A
 Operation TemperatureGold inner contact -55°C to +125°C
 Tin/lead inner contact -55°C to +105°C



Angle Mount DIP Sockets

500 Series

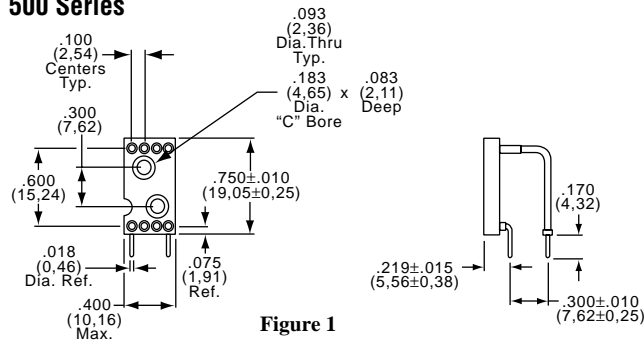

Figure 1

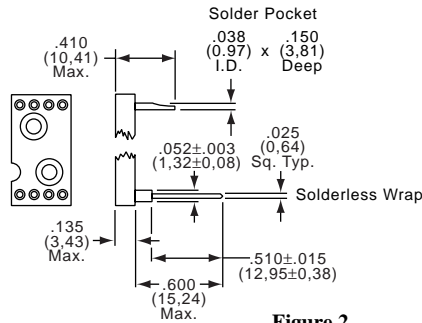

Figure 2

PART NUMBERS / STANDARD CONFIGURATIONS

Part Number	Figure	Number of Contacts	Description
508-AG8D	1	8	Right angle mtg., printed circuit
508-AG4A	2	8	Horizontal mtg., solder pocket
508-AG4F	2	8	Horizontal mtg., 3 level solderless wrap

PART NUMBER / STANDARD CONFIGURATIONS

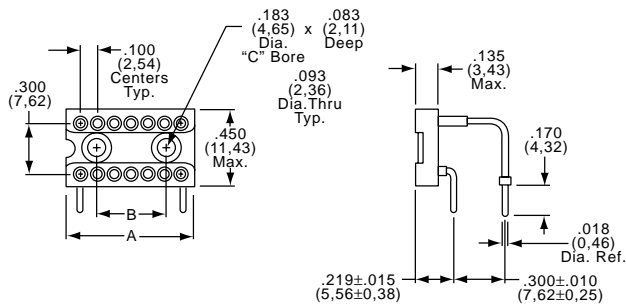

Figure 3
Horizontal Right Angle

Part Number	Number of Contacts	A Max.	B	Description
508-AG7D	8	.400 (10.16)	One Hole Only	Right angle mtg., printed circuit
514-AG7D	14	.700 (17.78)	.400 (10.16)	
516-AG7D	16	.800 (20.32)	.500 (12.70)	
518-AG7D	18	.900 (22.86)	.600 (15.24)	
520-AG7D	20	1.000 (25.40)	.500 (12.70)	

PART NUMBER / STANDARD CONFIGURATIONS

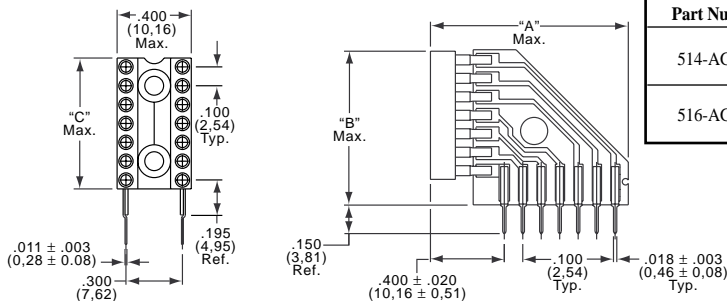

Figure 4
Vertical Right Angle

Part Number	Number of Contacts	"A" Max.	"B" Max.	"C" Max.
514-AG21D	14	1.100 (27.49)	.900 (22.86)	.700 (17.78)
516-AG21D	16	1.220 (30.99)	1.010 (25.65)	.800 (20.32)

Note: Before ordering, see Cross Reference in Section 15 for equivalent Tyco Electronics Part Number.

Ganged DIP Sockets

500 Series

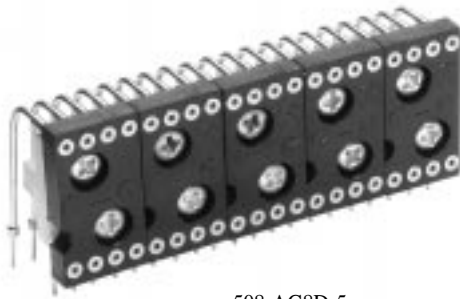

508-AG8D-5

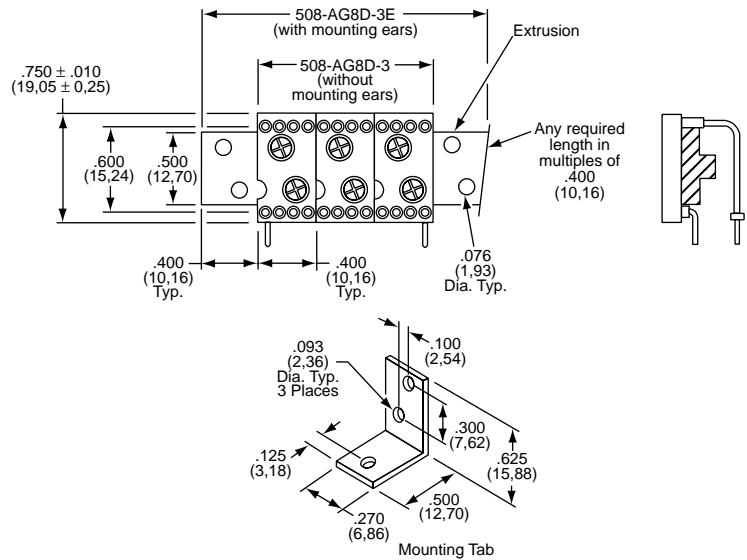

GANGED UNIT ASSEMBLIES:

The 508 Series numbers in part block are individual sockets. Add required dash number to appropriate socket part number for ganged unit assemblies. With or without extrusion extension (serves as mounting ears). Units with extrusion extensions are furnished with four No. 2 x 1/4" long self-tapping screws.

EXTRUSION:

Extrusion for ganging also available separately, part number 508-5G1. Simply add suffix number to indicate required length. Each extrusion is furnished with No. 2 x 1/4" long self-tapping screws, quantity same as number of holes in extrusion.

MOUNTING TAB:

Part number 508-4P1 is used for mounting ganged unit assemblies. Sold separately if required.

MATERIAL SPECIFICATIONS:

Inner Contact.....Four-fingered beryllium copper, gold
 Outer SleeveMachined brass, tin/lead plated
 Insulator.....Thermoplastic polyester UL rated 94V-0
 ExtrusionVinyl
 Mounting TabStainless steel .032 (0,81) thick

HOW TO ORDER

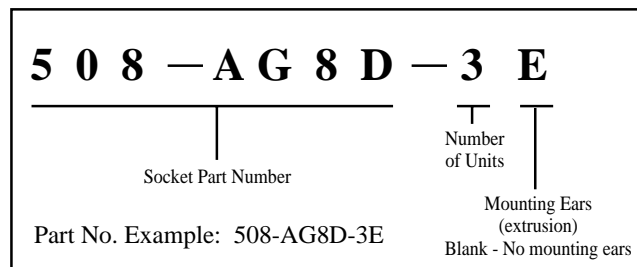

PERFORMANCE SPECIFICATIONS:

MECHANICAL

VibrationPassed MIL-STD-1344, Method 2005.1, Condition II, 10 G's
 ShockPassed MIL-STD-1344, Method 2004.1, Condition C, 100 G's
 DurabilityPassed MIL-STD-1344, Method 2016
 Normal Force200 Grams (7.0 oz.) average with .018" (0,46) dia. polished steel pin
 Insertion Force179 Grams (6.3 oz.) average with .018" (0,46) dia. polished steel pin
 Withdrawal Force63 Grams (2.2 oz.) average with .018" (0,46) dia. polished steel pin
 SolderabilityPassed MIL-STD-202F, Method 208
 Sleeve Retention in Plastic3.0 Lbs. per line minimum PC tail
 Inner Contact Retention7.5 Lbs. per line average

ELECTRICAL

Contact Resistance10 Milliohms
 Contact Rating3 Amps
 Capacitance1.0 pF per MIL-STD-202, Method 305 (contact to contact)
 Insulation Resistance5,000 Megohms min. @ 500 VDC per MIL-STD-1344, Method 3003.1
 Dielectric Withstanding Voltage1,000 Volts RMS per MIL-STD-1344, Method 3001.1

ENVIRONMENTAL

HumidityPassed MIL-STD-1344, Method 1002.2, Cond. II
 Thermal ShockPassed MIL-STD-1344, Method 1003.1, Cond. A
 Operation TemperatureGold inner contact -55°C to +125°C
 Tin/lead inner contact -55°C to +105°C

Note: Before ordering, see Cross Reference in Section 15 for equivalent Tyco Electronics Part Number.



Sockets

Crystal Socket Assemblies

8000-AG & 8004-1G Series



8000-AG2

FEATURES:

The crystal socket assembly is a high quality component manufactured with superior materials designed for dependable mechanical and electrical life. Developed for use with a broad spectrum of crystal sizes, the crystal package can easily be inserted and removed without removing and adjusting latches and/or screws. Once the crystal has been installed it will not shake loose even under severe vibration.

- 8000 Series miniature style is designed to accommodate HC-6/μ, HC-13μ, HC-14μ, HC-27μ, HC-36μ and HC-48μ crystal sizes
- 8004 Series subminiature style is designed to accommodate HC-18μ, HC-25μ, HC-42μ, HC-43μ, HC-49μ and HC-50μ crystal sizes
- Contact designs include flow-solder, horizontal solder eyelet and right angle solder eyelet tails, in both machined sleeve and stamped contact variations
- Provides maximum protection of crystal devices in severe shock and vibration environments
- Insulators offered in teflon and nylon materials
- Broad range of clip and contact materials
- Acts as additional heat sink to protect crystal against temperature variations

MATERIAL SPECIFICATIONS:

InsulatorsTeflon or blue nylon
 Contacts.....Beryllium copper
 Contact PlatingGold or tin
 Holding ClipsBeryllium copper alloy, cadmium plated with gold iridite

PERFORMANCE SPECIFICATIONS: 8000 SERIES

MECHANICAL

Vibration10 to 2,000 Hz at 15 G's with crystal mounted, no movement of crystal or damage assembly

ELECTRICAL

Bulk Resistance.....15 Milliohms @ 30 millivolts
 Capacitance to Ground (Contact to Holding Clip)5pF @ 1,000 Hz
 Capacitance Between Contacts3pf @ 1,000 Hz
 Dielectric Withstanding Voltage2,500 RMS @ sea level, 400 RMS @ 70,000 ft.

ENVIRONMENTAL

Temperature Range (For Crystal Socket Only)-55°C to + 125°C
 Salt Spray5% for 48 hours, no breakdown of plating or damage to base metal

PERFORMANCE SPECIFICATIONS: 8004 SERIES

MECHANICAL

Vibration10 to 2,000 Hz @ 15 G's

ELECTRICAL

Bulk Resistance.....10 Milliohms
 Capacitance to Ground (Contact to Holding Clip)8pF
 Capacitance Between Contacts5 pF
 Dielectric Withstanding Voltage2,500 RMS

ENVIRONMENTAL

Temperature Range (For Crystal Socket Only)-55°C to + 125°C
 Salt Spray5% solutions for 48 hours

Crystal Socket Assemblies

8000-AG & 8004-1G Series

PART NUMBER / STANDARD CONFIGURATIONS

Accepts .017 (0,43) Diameter Leads Crystal Styles: HC-18μ, HC-43μ, HC-49μ						
Socket Part Number	Figure	Description	Contact Material	Contact Design	Contact Plating	Insulation Material
8004-23G1	2	Printed circuit mount with anti-rotating tab	Beryllium Copper	Machined	Gold	Teflon
Accepts .040 (1,02) Diameter Leads Crystal Styles: HC-25μ, HC-42μ, HC-50μ						
Socket Part Number	Figure	Description	Contact Material	Contact Design	Contact Plating	Insulation Material
8004-1G16	2	Printed circuit mount with anti-rotating tab	Beryllium Copper	Machined	Gold	Teflon
8004-1G4	1	Printed circuit mount with anti-rotating tab	Phosphor Bronze	Stamped		
8004-1G23	2	Printed circuit mount without anti-rotating tab	Beryllium Copper	Machined		
8004-1G1	1	Horizontal mount with anti-rotating tab	Phosphor Bronze	Stamped		
8004-1G2	1	Horizontal mount without anti-rotating tab				
8004-1G3	1	Printed circuit mount with anti-rotating tab				
8004-1G26	1	Horizontal mount without anti-rotating tab	Beryllium Copper			
Accepts .050 (1,27) Diameter Leads Crystal Styles: HC-6μ, HC-13μ, HC-14μ, HC-27μ, HC-36μ, HC-48μ						
Socket Part Number	Figure	Description	Contact Material	Contact Design	Contact Plating	Insulation Material
8000-AG1	3	Horizontal mount with anti-rotating tab	Phosphor Bronze	Stamped	Gold	Teflon
8000-AG2	3	Horizontal mount without anti-rotating tab				
8000-AG9	4	Printed circuit mount with anti-rotating tab				
8000-AG3	3					
8000-AG36	5					
8000-AG4	3	Printed circuit mount without anti-rotating tab				Gold

Note: Before ordering, see Cross Reference in Section 15 for equivalent Tyco Electronics Part Number.

5 Sockets

Crystal Socket Assemblies

8000-AG & 8004-1G Series

FIGURE 3



8000-AG2

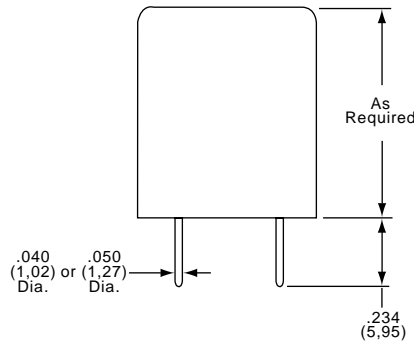

Crystal Outline Drawing

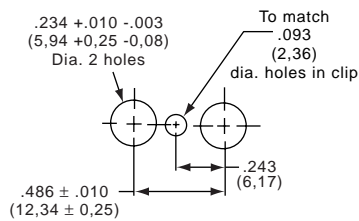

For Vertical Mounting

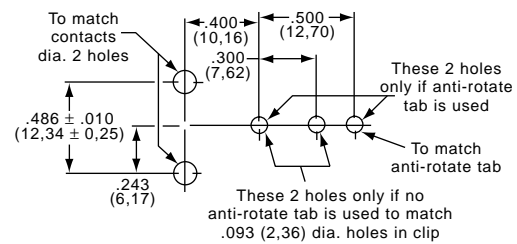
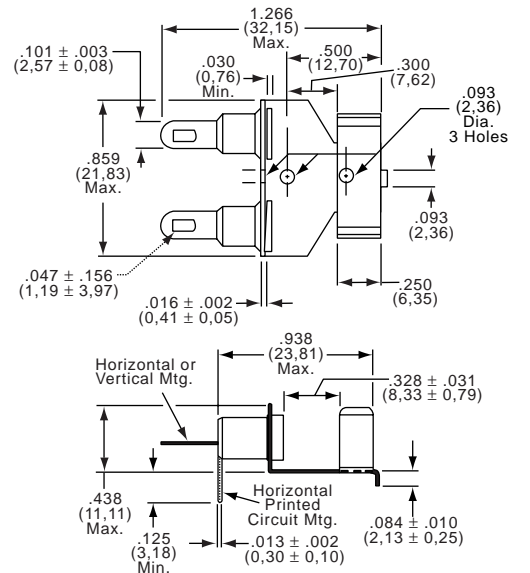

For Horizontal or Printed Circuit Mounting

FIGURE 4



8000-AG9

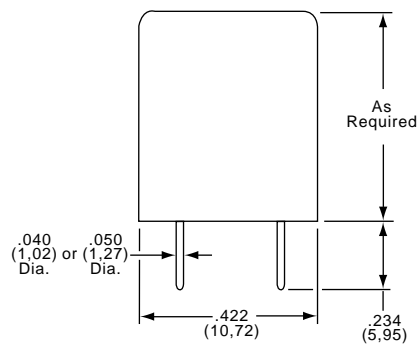

Crystal Outline Drawing

Crystal Outline Drawing

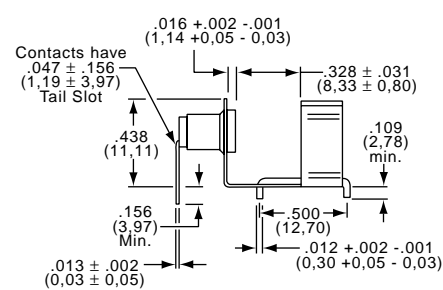
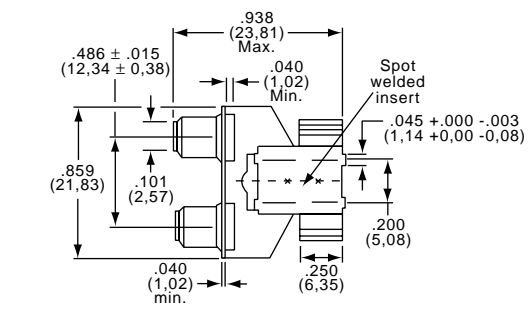

To clear contacts (2 places)

To clear tabs of spot welded insert (4 places)

Note: Before ordering, see Cross Reference in Section 15 for equivalent Tyco Electronics Part Number.

Crystal Socket Assemblies

8000-AG & 8004-1G Series

FIGURE 5

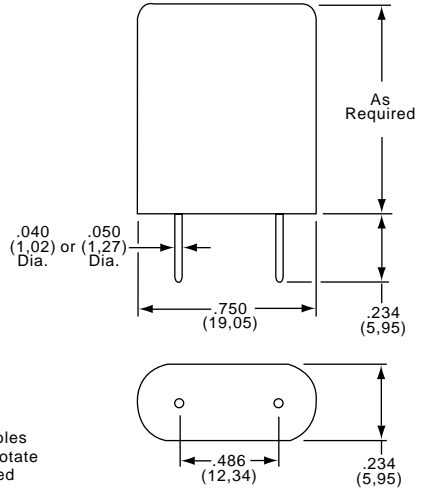
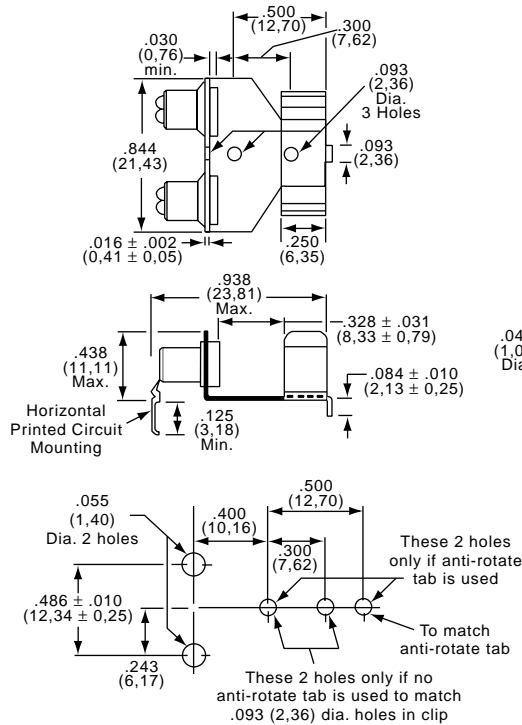

Note: Before ordering, see Cross Reference in Section 15 for equivalent Tyco Electronics Part Number.

Crystal Outline Drawing

Courtesy of Steven Engineering, Inc. • 230 Ryan Way, South San Francisco, CA, 94080-6370 • Main Office: (650) 588-9200 • Outside Local Area: (800) 258-9200 • www.stevenengineering.com

Programming Jumper Plug Assemblies

8136-875 Series



8136-475G8

FEATURES:

8136-475 Series of programmed jumper plugs offer the unique combination of low cost and flexible signal path selection. Standard configurations are supplied programmed across rows. Special configurations are available side by side and across row, intermixed programmed signal path variations.

- Low profile; only .100" (2,54) high, "X" & "Y" stackability
- Available with gold or tin plating
- Available in standard units of 1,2,3,4,7,8,9 (double pin)
- Jumper pin assembly spans .300" (7,62) centers to connect opposing contacts in I.C. patterns, or .100" (2,54) centers to connect adjacent pins
- Also available in special configurations combining .100" (2,54) center shorting pins with .300" (7,62) center pins
- To allow greater flexibility, individual jumper pins and insulators are available for installation by the customer (simple press assembly)

MATERIAL SPECIFICATIONS:

Insulator.....Thermoplastic polyester, UL rated 94V-0
 PinPhosphor bronze
 PlatingGold or tin

PERFORMANCE SPECIFICATIONS:

MECHANICAL

SolderabilityMIL-STD-202, Method 208

ELECTRICAL

Current Rating.....3 Amps DC
 Operating Voltage.....500 Volts RMS at atmospheric pressure
 Dielectric Withstanding
 Voltage2,500 Volts RMS for 5 seconds
 Bulk Resistance.....10 Milliohms at .020 Amps DC
 Insulation Resistance..... 2×10^9 Ohms at 90% relative humidity

ENVIRONMENTAL

Operating Temperature-65°C to +125°C

Note: Before ordering, see Cross Reference in Section 15 for equivalent Tyco Electronics Part Number.



Sockets

Programming Jumper Plug Assemblies

8136-475 Series

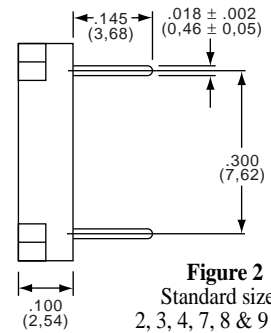
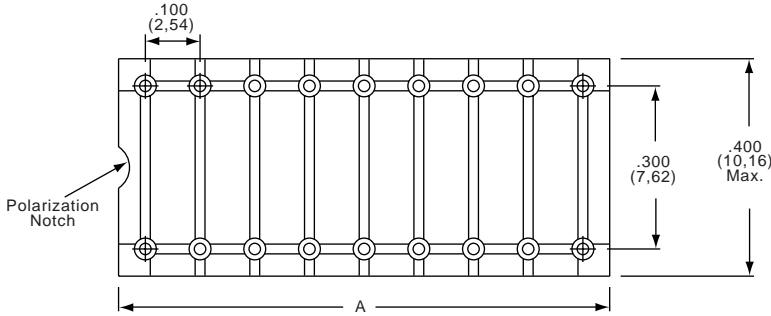

Figure 2
Standard sizes:
2, 3, 4, 7, 8 & 9 units

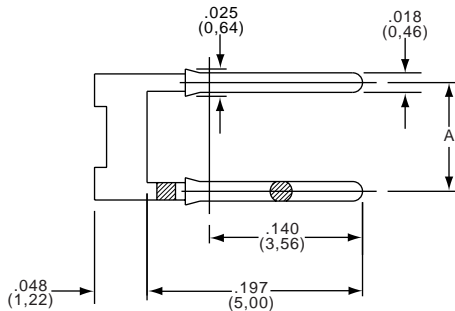

Figure 3
Jumper pin

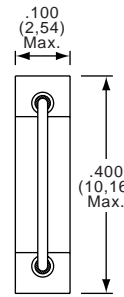

Figure 1
Single unit

INSULATOR ONLY

Size	Part Number	Dimension A
Insulator-1 Unit	8136-477P1	.100 (2,54)
Insulator-2 Units	8136-652P6	.200 (5,08)
Insulator-3 Units	8136-652P1	.300 (7,62)
Insulator-4 Units	8136-652P2	.400 (10,16)
Insulator-7 Units	8136-652P3	.700 (17,78)
Insulator-8 Units	8136-652P4	.800 (20,32)
Insulator-9 Units	8136-652P5	.900 (22,86)

Note: Before ordering, see Cross Reference in Section 15 for equivalent Tyco Electronics Part Number.

PART NUMBER / STANDARD CONFIGURATIONS

Gold Part Number	Figure	Number of Units	Dim. A
8136-475G1	1	1	----
8136-475G2	2	2	.200 (5,08)
8136-475G3	2	3	.300 (7,62)
8136-475G4	2	4	.400 (10,16)
8136-475G7	2	7	.700 (17,78)
8136-475G8	2	8	.800 (20,32)
8136-475G9	2	9	.900 (22,86)
8136-651P2 (gold)	3	Jumper Pin	.100 (2,54)
8136-651P3 (tin)	3	Jumper Pin	.100 (2,54)
8136-650P2 (gold)	3	Jumper Pin	.300 (7,62)
8136-650P3 (tin)	3	Jumper Pin	.300 (7,62)

* For tin-plated version of Figs. 1&2, use suffix "T" after part number.
Example: 8136-475G1T.

Courtesy of Steven Engineering, Inc. • 230 Ryan Way, South San Francisco, CA, 94080-6370 • Main Office: (650) 588-9200 • Outside Local Area: (800) 258-9200 • www.stevenengineering.com

Fuse Sockets

500 Series



510-21232

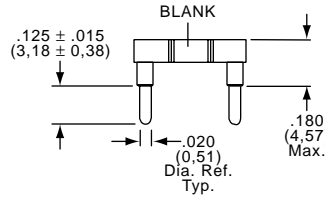
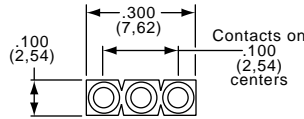

FEATURES:

AMP offers a SIP style socket for use with PC fuses.

- Precision four-finger inner contact provides concentric funnel entry for easy flat and round lead insertion
- Non-wicking, closed bottom sleeve gives 100% protection against flux and solder contamination
- BeCu inner contact for maximum mechanical and electrical performance

APPLICATION DIMENSIONS:

- PCB Thickness Range: Standard .062" and .092" (1,57 and 2,34)
- PCB Hole Size Range: .035" ± .003" (0,89 ± 0,08) PC tail
- IC Pin Dimension Range: .009" x .015" (0,23 x 0,38) through .011" x .020" (0,28 x 0,51) .016" to .021" (0,41 to 0,53) round lead, .105"(2,67) min. length

MATERIAL SPECIFICATIONS:

- Insulator.....Thermoplastic polyester, UL rated 94V-0
- Inner Contact.....Four-fingered beryllium copper, gold over nickel plated
- Outer SleeveMachined brass, gold over nickel or tin/lead over copper plated

PART NUMBER

Part Number	Contact Plating	Sleeve Plating
510-21114	Gold	Tin/Lead
510-21232	Tin/Lead	Tin/Lead

Note: Before ordering, see Cross Reference in Section 15 for equivalent Tyco Electronics Part Number.

PERFORMANCE SPECIFICATIONS:

MECHANICAL

- VibrationPassed MIL-STD-1344, Method 2005.1, Condition II, 10 G's
- Shock.....Passed MIL-STD-1344, Method 2004.1, Condition C, 100 G's
- DurabilityPassed MIL-STD-1344, Method 2016
- Normal Force200 Grams (7.1 oz.) average with a .018" (0,46) dia. polished steel pin
- Inner Contact Retention7.5 Lbs. per line average
- Sleeve Retention in Plastic.....3.0 Lbs. per line minimum
- SolderabilityPassed MIL-STD-202F, Method 208
- Insertion Force179 Grams (6.3 oz.) average with a .018" (0,46) dia. polished steel pin
- Withdrawal Force63 Grams (2.2 oz.) average with a .018" (0,46) dia. polished steel pin

ELECTRICAL

- Contact Resistance10 Milliohms max.
- Contact Rating.....3 Amps
- Capacitance1.0 pF per MIL-STD-202, Method 305 (contact to contact)
- Insulation Resistance.....5,000 Megohms min. @ 500 VDC per MIL-STD-1344, Method 3003.1
- Dielectric Withstanding Voltage1,000 Volts RMS per MIL-STD-1344, Method 3001.1

ENVIRONMENTAL

- HumidityPassed MIL-STD-1344, Method 1002.2, Cond. II
- Thermal ShockPassed MIL-STD-1344, Method 1003.1, Cond. A
- Operation Temperature....Gold inner contact -55°C to +125°C
Tin/lead inner contact -55°C to +105°C



Crystal Oscillator Sockets

500 Series



504-AG11D

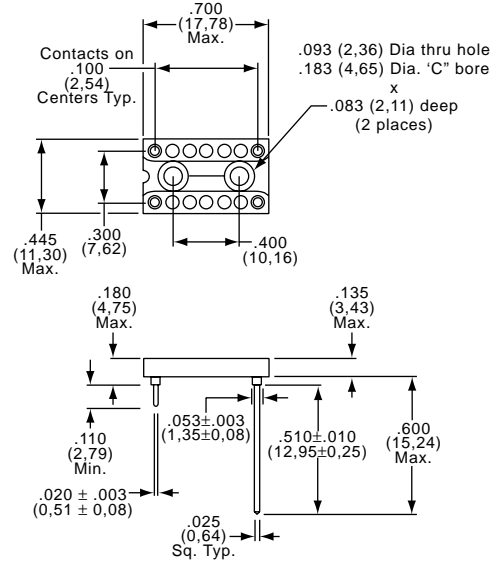

FEATURES:

- Accommodates any component leads with .016" to .021" (0,41 x 0,53) diameter
- Withstands most severe environmental conditions including military requirements of high shock and vibration
- Low profile
- Contact features closed end construction eliminating any solder or flux wicking problems
- Two-piece tapered entry socket terminal features a four-finger, inner contact and machined outer sleeve

APPLICATION DIMENSIONS:

- PCB Thickness Range: Standard .062" and .092" (1,57 and 2,34)
- PCB Hole Size Range: .035" ± .003" (0,89 ± 0,08) PC tail, .055" ± .003" (1,40 ± 0,08) solderless wrap
- IC Pin Dimension Range: .016" to .021" (0,41 to 0,53) round lead, .105"(2,67) min. length

MATERIAL SPECIFICATIONS:

- Insulator.....Thermoplastic polyester, UL rated 94V-0
- Inner Contact.....Four-fingered beryllium copper, gold over nickel plated
- Outer SleeveMachined brass, gold over nickel or tin/lead over copper plated

PART NUMBER / STANDARD CONFIGURATIONS

Part Number	Number of Contacts	Contact Plating	Sleeve Plating	Termination Style
504-AG10D	4	Gold	Gold	Printed Circuit
504-AG11D			Tin/Lead	
504-AG12D		Tin/Lead	Tin/Lead	
504-AG10F		Gold	Gold	Solderless Wire Wrap
504-AG11F			Tin/Lead	

PERFORMANCE SPECIFICATIONS:

MECHANICAL

- VibrationPassed MIL-STD-1344, Method 2005.1, Condition II, 10 G's
- Shock.....Passed MIL-STD-1344, Method 2004.1, Condition C, 100 G's
- DurabilityPassed MIL-STD-1344, Method 2016
- Normal Force200 Grams (7.1 oz.) average with .018" (0,46) dia. polished steel pin
- Inner Contact Retention7.5 Lbs. per line average
- Sleeve Retention in Plastic.....3.0 Lbs. per line minimum
- SolderabilityPassed MIL-STD-202F, Method 208
- Insertion Force179 Grams (6.3 oz.) average with a .018" (0,46) dia. polished steel pin
- Withdrawal Force63 Grams (2.2 oz.) average with a .018" (0,46) dia. polished steel pin

ELECTRICAL

- Contact Resistance10 Milliohms max.
- Contact Rating.....3 Amps
- Capacitance1.0 pF per MIL-STD-202, Method 305 (contact to contact)
- Insulation Resistance.....5,000 Megohms min. @ 500 VDC per MIL-STD-1344, Method 3003.1
- Dielectric Withstanding Voltage1,000 Volts RMS per MIL-STD-1344, Method 3001.1

ENVIRONMENTAL

- HumidityPassed MIL-STD-1344, Method 1002.2, Cond. II
- Thermal ShockPassed MIL-STD-1344, Method 1003.1, Cond. A
- Operation TemperatureGold inner contact -55°C to +125°C
Tin/lead inner contact -55°C to +105°C

Note: Before ordering, see Cross Reference in Section 15 for equivalent Tyco Electronics Part Number.

Transistor & IC Low Profile Sockets

8059 Series



8059-2G7

FEATURES:

The 8059 Series TO-5 transistor sockets are manufactured with a beryllium copper precision four fingered inner contact and brass outer sleeve. Insulators are molded in five brilliant polyamide colors, for rapid visual identification of socket pin count or pin circle. This inexpensive family of transistor sockets is available with either gold or tin/lead sleeves for even more economy.

- Ultra low profile
- Closed entry design -no distortion or damage to contact with misaligned or oversized lead
- Gold plated contacts, choice of gold or tin/lead plated leads
- Sockets accept .016 to .020 (0,41 to 0,51) diameter leads
- Five brilliant colors for easy identification when mounted on PCB
- Closed end sleeve design completely eliminates the possibility of flux or solder wicking into the contact area
- Large tapered entry for easy insertion of transistor devices

MATERIAL SPECIFICATIONS:

Insulator.....Glass filled polyamide nylon, UL rated 94V-0
 SleeveBrass
 ContactBeryllium copper
 Plating
 ContactGold
 SleeveTin/lead or gold

PERFORMANCE SPECIFICATIONS:

MECHANICAL

VibrationPassed MIL-STD-1344, Method 2005, 15 G's, 10 to 2,000 cycles
 Mechanical Shock.....Passed MIL-STD-1344, Method 2004, 10 G's, 1 to 9,000 cycles
 Durability50 Insertions and withdrawals, MIL-S-83502/1, Sec 4.7.12
 Insertion Force4.0 lb. Max., .020 dia. +.0000 probe -.0002
 Withdrawal Force14 Grams (1/2 oz.) min., .016 dia. +.0002 probe -.0001
 SolderabilityMIL-STD-202, Method 208

ELECTRICAL

Bulk Contact
 Resistance20 Milliohms max per MIL-S-83502/1
 Current Rating.....3 Amps DC
 Operating Voltage.....750 VDC
 Dielectric Withstading
 Voltage600 VAC per MIL-STD-1344, Method 3001
 Insulation Resistance.....2 x 10⁶ Megohms, MIL-STD-1344, Method 3003
 Capacitance2pF Max., MIL-STD-202, Method 305

ENVIRONMENTAL

Operating Temperature-55°C to +125°C
 Corrosive Atmosphere30 Milliohms, amonium polysulfide 10 ppm per MIL-S-83502/1 sec. 4.7.17
 Moisture Resistance30 Milliohms max., MIL-STD 202, Method 106
 Thermal ShockMIL-STD-1344, Method 1003

Note: Before ordering, see Cross Reference in Section 15 for equivalent Tyco Electronics Part Number.



Transistor & IC Low Profile Sockets

8059 Series

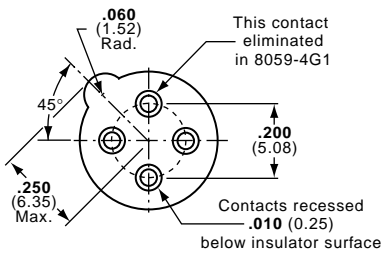

Figure 1

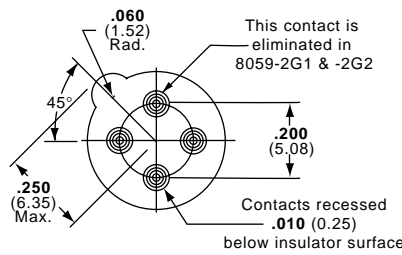

Figure 2

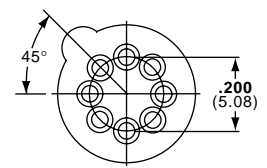

Figure 3

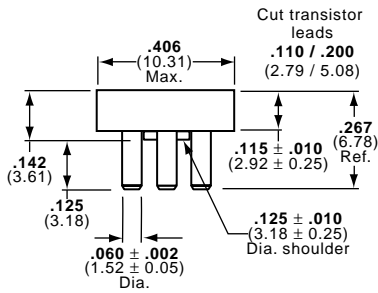

Figure A

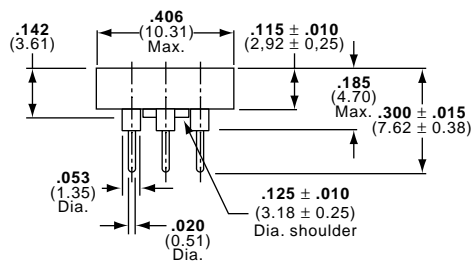

Figure B

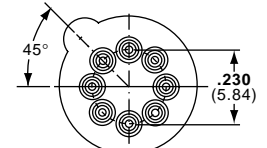

Figure 4

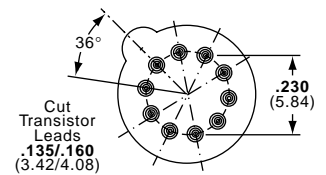

Figure 5

PART NUMBER / STANDARD CONFIGURATIONS

Part Number	Figure	Number of Contacts	Pin Circle	Contact Plating	Sleeve Plating	Insulator Color
8059-4G1	1, A	3	.200 (5,08)	Gold	Gold	Red
8059-2G1	2, B			Gold	Gold	
8059-2G2				Gold	Tin/Lead	
8059-4G4	1, A	4		Gold	Gold	Blue
8059-2G3	2, B			Gold	Gold	
8059-2G4		Gold		Tin/Lead		
8059-2G5	3, B	8		Gold	Gold	Green
8059-2G6				Gold	Tin/Lead	
8059-2G7	4, B			Gold	Gold	Orange
8059-2G8				Gold	Tin/Lead	
8059-2G9	5, B	10	.230 (5,84)	Gold	Gold	Yellow
8059-2G10				Gold	Tin/Lead	

Note: Before ordering, see Cross Reference in Section 15 for equivalent Tyco Electronics Part Number.

Transistor Sockets

8058 & 8060 Series



8060-1G11



8060-1G6

FEATURES:

The 8058/8060 family of teflon sockets, with beryllium copper contacts, offers many features which allow them to be utilized in the most severe applications. Low profile for close board spacing, closed sleeve for 100% prevention of solder and flux wicking. A choice of many terminal styles for greater packaging selection and ease of use. Many of these sockets meet or exceed MIL-S-83502/2 and MIL-S-83502/5.

- Two-piece socket terminal - four fingered inner contact and machined outer sleeve
- Low profile for tight space applications
- Sockets accept 0,41/.016 to 0,51/.020 diameter leads
- Printed circuit, solder pocket and turret style terminations available
- Closed entry-design no distortion or damage to contact with misaligned or oversized leads

MATERIAL SPECIFICATIONS:

InsulatorTeflon
 SleeveBrass
 Contact PlatingBeryllium copper
 PlatingContact gold, sleeve gold

Note: Before ordering, see Cross Reference in Section 15 for equivalent Tyco Electronics Part Number.

PERFORMANCE SPECIFICATIONS:

MECHANICAL

VibrationPassed MIL-STD -1344, Method 2005, 15 G's, 10 to 2,000 cycles
 Mechanical ShockPassed MIL-STD -1344, Method 2004, 10 G's, 1 to 9,000 cycles
 Durability50 Insertions and withdrawals, MIL-S-83502/ 1, Sec. 4.7.12
 Insertion Force4.0 lb. max., .020 dia. +.0000 probe -.0002
 Withdrawal Force14 Grams (1/2 oz.) min. .016 dia. +.0002 probe -.0001
 SolderabilityMIL-STD- 202, Method 208

ELECTRICAL

Bulk Contact
 Resistance20 Milliohms max. per MIL-S-83502/1
 Current Rating3 Amp DC, contact rating
 Operating Voltage500 VDC @ atmospheric pressure
 Dielectric Withstanding
 Voltage600 VAC per MIL-STD -1344 , Method 3001
 Insulation Resistance2 x 10⁶ Megohms, MIL-STD -1344, Method 3003
 Capacitance2 pF Max., MIL-STD -202, Method 305

ENVIRONMENTAL

Operating Temperature-55°C to +125°C
 Corrosive Atmosphere30 milliohms, ammonium polysulfide 10 ppm per MIL-S-83502/1 Sec. 4.7.17
 Moisture Resistance30 Milliohms max., MIL-STD -202, Method 106
 Thermal ShockMIL-STD -1344, Method 1003



Sockets

Transistor Sockets

8058 & 8060 Series

PART NUMBER / STANDARD CONFIGURATIONS

Part Number	Figure	No. of Contacts	Pin Circle	A	B	C	D	E*	F Max.	Terminal Style	Mounting Hole	Transistor Lead Length	Polarization Figure
M8058-45G1	1	3	.200	.200	.265	.373	.410	.160	.406	Turret	B	.156/.218	N
M8058-1G29	3	3	.200	.200	.270	.373	.410	.140	.351	Solder Pocket			
8058-1G29	3	3	.200	.200	.270	.373	.410	.140	.351	Printed Circuit	—	.125/.155	P
8058-1G23	4	3	.200	.200	.270	.373	.410	.302	.544				
M8058-1G23	4	3	.200	.200	.270	.373	.410	.302	N/A				
8058-1G59	6	3	.200	.200	.165	N/A	.410	.125	N/A	Wirewrap	B	.156/.218	N
8058-38G6	6	3	.200	.200	.165	N/A	.410	.315	N/A				
8058-1G62	7	3	.200	.200	.270	.373	.410	.500	.703				
M8058-45G2	1	4	.200	.200	.265	.373	.410	N/A	.406	Turret	B	.156/.218	N
M8058-1G30	3	4	.200	.200	.265	.373	.410	.140	.377				
8058-1G30	3	4	.200	.200	.270	.373	.410	.140	.347	Solder Pocket	—	.125/.155	P
M8058-1G24	4	4	.200	.200	.270	.373	.410	.347	.550				
8058-1G24	4	4	.200	.200	.270	.373	.410	.317	.550	Printed Circuit	B	.156/.218	N
8058-1G63	7	4	.200	.200	.270	.373	.410	.500	.703				
8058-1G58	2	5	.200	.200	.270	.373	.410	.094	.331	Turret	—	.125/.155	P
8058-1G61	3	5	.200	.200	.270	.373	.410	.140	.336				
M8058-1G39	2	6 at 45°	.200	.200	.270	.373	.410	.094	.300	Turret	B	.156/.218	N
8058-1G43	3	6 at 60°	.200	.200	.270	.373	.410	.140	.370				
M8058-1G18	3	6 at 45°	.200	.200	.270	.373	.410	.140	.370	Solder Pocket	—	.125/.155	P
8058-1G42	4	6 at 60°	.200	.200	.270	.373	.410	.317	.561				
M8058-1G33	4	6 at 45°	.200	.200	.270	.373	.410	.317	.561	Printed Circuit	B	.156/.218	N
8058-1G48	6	6 at 60°	.200	.200	.165	N/A	.410	.125	N/A				
8058-1G52	6	6 at 45°	.200	.200	.165	N/A	.410	.125	N/A	Turret	—	.125/.155	P
M8058-1G37	2	8	.200	.200	.270	.373	.410	.094	.336				
M8058-1G19	3	8	.200	.200	.270	.373	.410	.140	.377	Solder Pocket	B	.156/.218	N
8058-1G19	3	8	.200	.200	.270	.373	.410	.140	.377				
8058-1G57	3	8	.200	.200	.270	.373	.410	.140	.315	Printed Circuit	—	.125/.155	P
M8058-1G32	4	8	.200	.200	.270	.373	.410	.317	.550				
8058-1G32	4	8	.200	.200	.270	.373	.410	.317	.550	Turret	B	.156/.218	N
8058-39G1	5	8	.200	.330	.375	.373	.410	.187	.505				
8058-39G3	5	8	.200	.380	.375	.373	.410	.150	.470	Printed Circuit	—	.125/.155	P
8058-39G5	5	8	.200	.380	.375	.373	.410	.150	.470				
8058-1G49	6	8	.200	.200	.165	N/A	.410	.125	N/A	Turret	B	.156/.218	N
8058-1G47	2	8	.230	.230	.270	.373	.410	.094	.300				
8058-1G46	3	8	.230	.230	.270	.373	.410	.138	.346	Solder Pocket	—	.125/.165	P
8058-1G45	4	8	.230	.230	.270	.373	.410	.302	.534				
8058-39G4	5	8	.230	.380	.375	.373	.410	.155	.467	Printed Circuit	B	.156/.218	N
8058-39G6	5	8	.230	.380	.375	.373	.410	.150	.467				
8058-1G50	6	8	.230	.230	.165	N/A	.410	.125	N/A	Turret	—	.125/.155	P
M8058-1G38	2	10	.230	.230	.270	.373	.410	.094	.331				
M8058-1G22	3	10	.230	.230	.270	.373	.410	.141	.377	Solder Pocket	B	.156/.218	N
M8058-1G31	4	10	.230	.230	.270	.373	.410	.317	.561				
8058-1G31	4	10	.230	.230	.270	.373	.410	.317	.561	Printed Circuit	—	.125/.155	P
8058-24G1	5	10	.230	.380	.375	.373	.410	.187	.505				
8058-1G34	6	10	.230	.230	.165	N/A	.410	.125	N/A	Turret	B	.156/.218	N
M8058-1G91	6	10	.230	.230	.165	N/A	.410	.125	N/A				
8058-1G55	5	12	.250	.380	.375	.373	.410	.155	.467	Solder Pocket	—	.125/.155	P
8058-1G51	6	12	.280	.280	.165	N/A	.410	.125	N/A				

* Dimension E ± .031
(0,79)

Note: Before ordering, see Cross Reference in Section 15 for equivalent Tyco Electronics Part Number.

Transistor Sockets

8058 & 8060 Series

PART NUMBER / STANDARD CONFIGURATIONS

Part Number	Figure	Number of Contacts	Pin Circle	A	B	C	D	E*	F Max.	Terminal Style	Mtg. Hole Figure	Transistor Lead Length	Polarization Figure
8060-1G5	3	3	.100	.100	.268	.227	.255	.146	.350	Solder Pocket	A	.156/.218	N
8060-1G17	3	3	.100	.100	.320	.227	.255	.084	.427				
8060-1G9	2	3	.100	.100	.268	.227	.255	.094	.372	Turret	—	.125/.155	P
8060-1G11	4	3	.100	.100	.330	.227	.255	.240	.580				
8060-1G7	5	3	.100	.200	.410	.227	.255	.170	.616	Printed Circuit	—	.125/.155	P
8060-1G3	6	3	.100	.150	.195	N/A	.255	.103	N/A				
8060-1G13	6	3	.100	.100	.195	N/A	.255	.103	N/A	Solder Pocket	A	.156/.218	N
8060-1G6	3	4	.100	.100	.265	.227	.255	.146	.350				
8060-1G10	2	4	.100	.100	.265	.227	.255	.094	.310	Turret	—	.156/.218	N
8060-1G12	4	4	.100	.100	.330	.227	.255	.240	.553				
8060-1G8	5	4	.100	.200	.390	.227	.255	.187	.530	Printed Circuit	—	.125/.155	P
8060-1G4	6	4	.100	.150	.195	N/A	.255	.103	N/A				
8060-1G22	6	4	.100	.100	.195	N/A	.255	.295	N/A				

* Dimension E ± .031
(0,79)

All part number prefixed with (M) meet MIL-83502/1 or MIL-83502/6.

Note: Before ordering, see Cross Reference in Section 15 for equivalent Tyco Electronics Part Number.



Transistor Sockets

8058 & 8060 Series

Figure A
Recommended Chassis Cutout
for all 8060 Series panel
mount applications

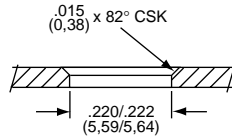

Figure B
Recommended Chassis Cutout
for all 8058 Series panel
mount applications

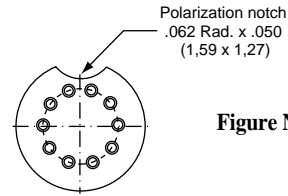
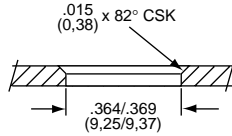

Figure N

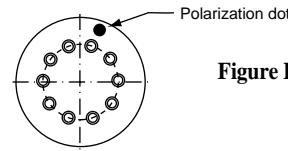

Figure P

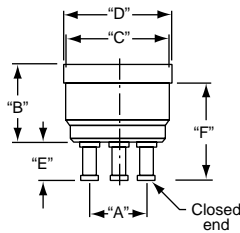

Figure 1

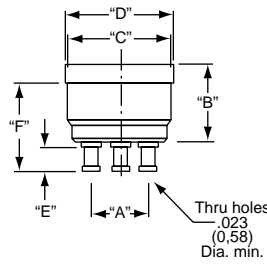

Figure 2

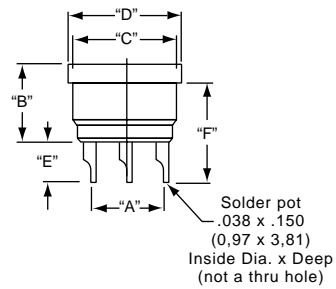

Figure 3

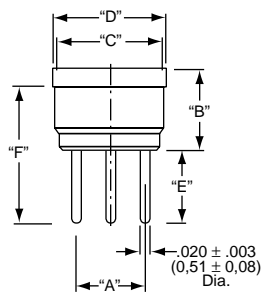

Figure 4

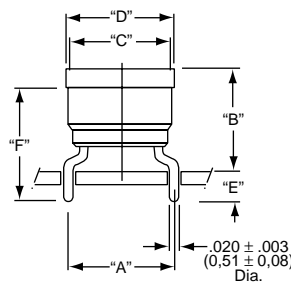

Figure 5

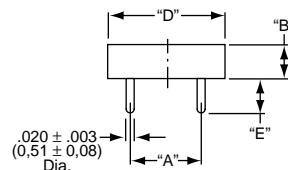

Figure 6

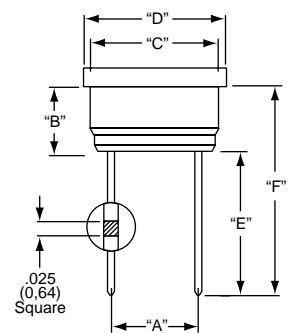

Figure 7

Note: Before ordering, see Cross Reference in Section 15 for equivalent Tyco Electronics Part Number.

Courtesy of Steven Engineering, Inc. • 230 Ryan Way, South San Francisco, CA, 94080-6370 • Main Office: (650) 588-9200 • Outside Local Area: (800) 258-9200 • www.stevenengineering.com

Lamp Sockets

8060 Series

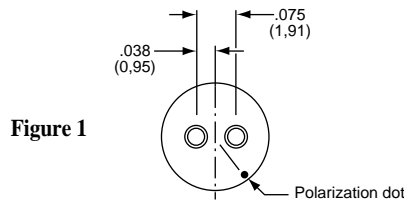

Figure 1

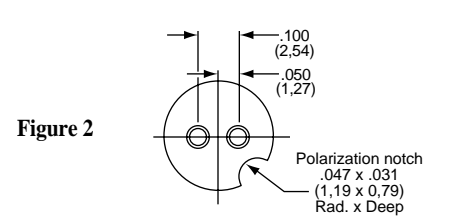

Figure 2

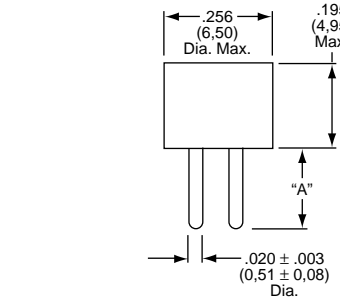

Figure 3

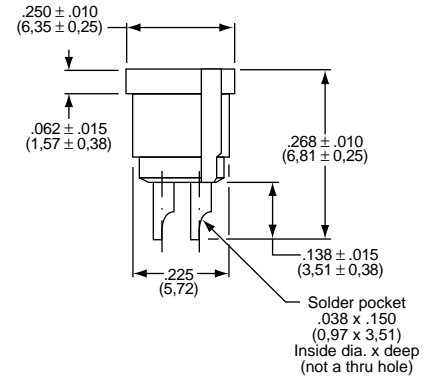
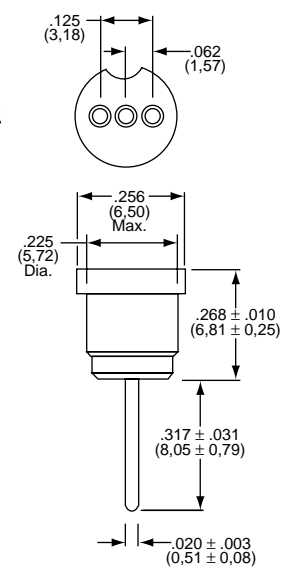
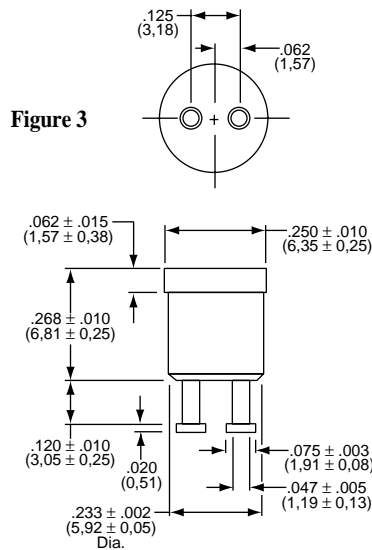

Figure 4



Recommended mounting hole .221 ± .001 (5,61 ± 0,03) - Break leading edge .015 (0,38) x 82° countersink

PART NUMBER / STANDARD CONFIGURATIONS

Part Number	Figure	Accept Lead Diameter	Cut Component Lead Length	A
8060-1G23	1	.016 - .020 (0,41 - 0,51)	.125 (3,18) minimum	.105 (2,67)
8060-1G25				.305 (7,75)
8060-1G34	2			—
8060-1G16	3	.025 (0,63)		—
8060-1G20	4	.016 - .020 (0,41 - 0,51)		.317 (8,05)

Note: Before ordering, see Cross Reference in Section 15 for equivalent Tyco Electronics Part Number.

TO-3 Power Transistor Sockets

8080-1G Series



8080-1G7

FEATURES:

The 8080-1G family of TO-3 Power Transistor Sockets is used for both small and large signal devices. Used in power supplies, power amplifiers, sweep amplifiers, and machine controlled equipment. These sockets are designed to constantly perform.

- Contact rating 10 amps. 20 Amps for 8080-1G44 VDE style
- Sockets accept components with .040 (1,02) .002 -.003 (+0,05 -0,08) diameter lead or .060 (1,52) +.002 -.003 (+0,05 -0,08) diameter leads
- Integral mounting saddle has 20 inch pounds min. thread strength
- Diallyl phthalate and phenolic insulators

MATERIAL SPECIFICATIONS:

- Insulator.....Black phenolic or green diallyl phthalate, UL rated 94V-0
- Mounting Saddle.....Brass, heat treated
- Saddle PlatingElectro-tin
- Insulating WasherMica .003 (0,08) thick
Ordered separately-part number 8038-3P1, Fig. 2
- Contacts.....Beryllium copper
- Contact PlatingTin, silver or gold

Note: Before ordering, see Cross Reference in Section 15 for equivalent Tyco Electronics Part Number.

PERFORMANCE SPECIFICATIONS:

MECHANICAL

- Vibration10 - 2,000 Hz, MIL-STD-202, Method 204, Condition B, transistor installed
- Durability50 Insertions per MIL-STD-12883
- Insertion Force6 Pounds max. per MIL-STD-12883
- Withdrawal Force18 Pounds min., 6 pounds max. per MIL-STD-12883
- Thread Strength.....20 Inch pounds minimum

ELECTRICAL

- Bulk Resistance.....Gold 15 milliohms, per MIL-STD-12883
Tin 25 milliohms max.
Silver 25 milliohms max.
- Current Rating10 Amps DC
- Insulation Resistance.....1,000 Megohms per MIL-STD-202
- Dielectric Withstanding
Voltage1,500 Volts RMS

ENVIRONMENTAL

- Operating Temperature-55°C to +125°C.
- Mechanical Shock.....Passed MIL-STD-12833, with transistor inserted at test gage



TO-3 Power Transistor Sockets

8080-1G Series

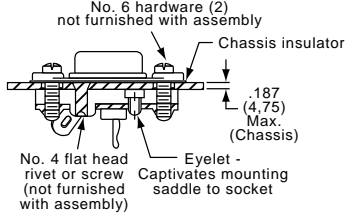

Figure 1

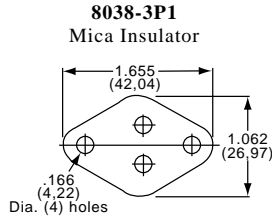
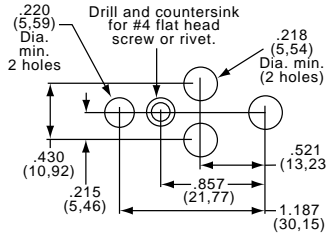

Figure 2

Recommended Chassis Cutout Standard



Recommended Chassis Cutout 8080-1G17 and 8080-1G45

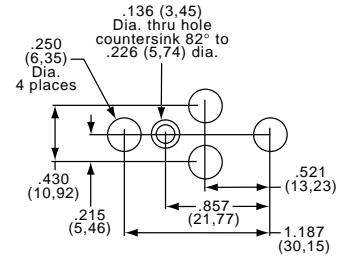

Figure 3

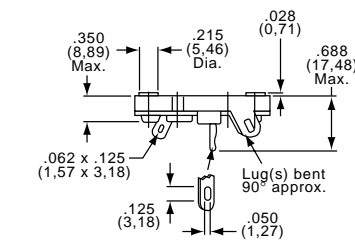
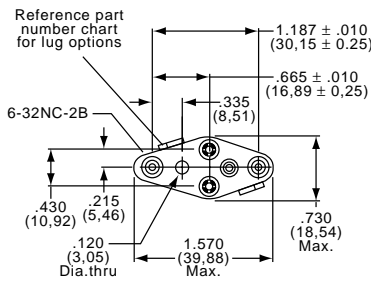

Figure 4

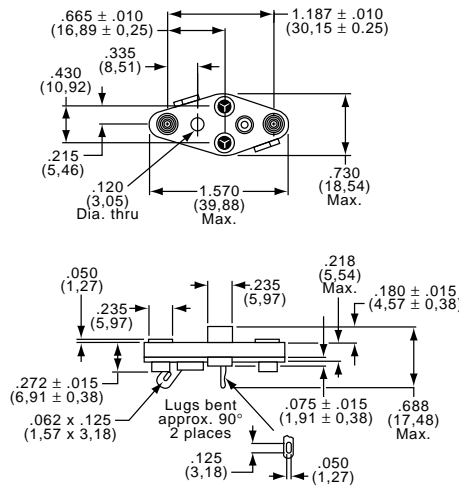

Figure 5

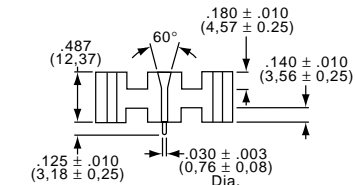
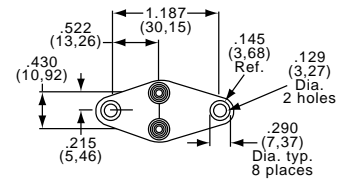

Figure 6

PART NUMBER / STANDARD CONFIGURATIONS

.040 Diameter Pin				
Part Number	Insulator	Contact Plating	Solder Lugs	Figure
8080-1G1	Phenolic	Electro-Tin	Two Solder Lugs	4
8080-1G45				5
8080-1G13	Diallyl Phthalate	Silver	Two Solder Lugs	4
8080-1G27	Phenolic			
8080-1G2	Diallyl Phthalate	Gold	Two Solder Lugs	4
8080-1G7	Phenolic			
8080-1G10	Diallyl Phthalate	Electro-Tin	Two Solder Lugs	4
8080-1G3	Phenolic			
8080-1G24	Diallyl Phthalate	Silver	One Solder Lug	4
8080-1G29	Phenolic			
8080-1G4	Diallyl Phthalate	Gold	One Solder Lug	4
8080-1G9	Phenolic			
8080-1G25	Diallyl Phthalate	Gold/Tin/Lead	P.C. Mount	7
8080-1G44	Thermoplastic Polyester			

PART NUMBER / STANDARD CONFIGURATIONS

.060 Diameter Pin				
Part Number	Insulator	Contact Plating	Solder Lugs	Figure
8080-1G15	Phenolic	Electro-Tin	Two Solder Lugs	4
8080-1G17				5
8080-1G31	Diallyl Phthalate	Silver	Two Solder Lugs	4
8080-1G32	Phenolic			
8080-1G16	Diallyl Phthalate	Gold	Two Solder Lugs	4
8080-1G33	Phenolic			
8080-1G34	Diallyl Phthalate	Electro-Tin	No Lugs	4
8080-1G20	Phenolic			
8080-1G14	Phenolic	Silver	One Solder Lug	4
8080-1G35	Diallyl Phthalate			
8080-1G36	Phenolic	Gold	One Solder Lug	4
8080-1G37	Diallyl Phthalate			
8080-1G38	Phenolic	Gold	One Solder Lug	4
8080-1G39	Diallyl Phthalate			

Note: Before ordering, see Cross Reference in Section 15 for equivalent Tyco Electronics Part Number.

Push Fit Test Jacks

8000 Series



8000-M65

FEATURES:

(8000-MG, 8007, and 8011 Series)

The 8000 Series is a line of sub-miniature "Push-Fit" test jacks used in many applications such as meter probe inputs, crystal sockets, circuit test point identification and many others. A complete line of test points which will accommodate .040 (1,02); .050 (1,27); .080 (2,03) and .090 (2,29) diameter pins.

- Teflon insulator for extreme environments
- Gold or tin plating available
- Brightly colored Nylon for fast test point identification
- Tapered entry to guide test probe

Note: Before ordering, see Cross Reference in Section 15 for equivalent Tyco Electronics Part Number.

PERFORMANCE SPECIFICATIONS:

ELECTRICAL

Bulk Contact

- Resistance10 Milliohms maximum
- Current Rating.....5 Amps DC
- Operating Voltage1,500 Volts RMS @ sea level
350 Volts RMS @ 50,000 feet
- Dielectric Withstanding
Voltage2,500 Volts RMS @ sea level
500 Volts RMS @ 50,000 feet
- Insulation Resistance.....5,000 x 10⁶ Ohms
- Capacitance4pF @ 5 MHz.

ENVIRONMENTAL

- Operating Temperature-65°C to +125°C

Push Fit Test Jacks

8000 Series

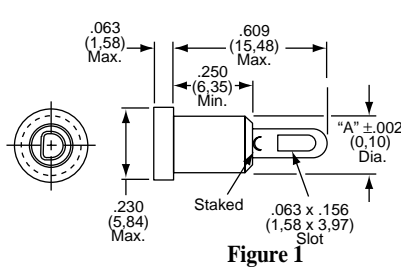

Figure 1

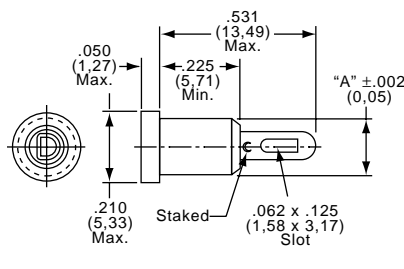

Figure 2

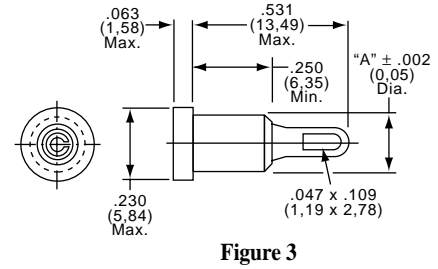

Figure 3

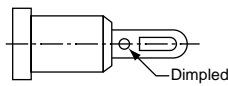
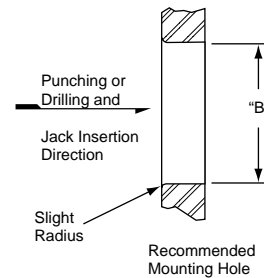

Figure 1A



PART NUMBER / STANDARD CONFIGURATIONS

Part Number	Figure	A *	Insulator Material & Color	Contact Material and Plating	Mtg. Hole B **	Probe Diameter	Part Number	Figure	A *	Insulator Material & Color	Contact Material and Plating	Mtg. Hole B **	Probe Diameter				
8007-1G1	2	.175	TEFLON, Natural	Phos. Bronze, Gold	.162	.040	8011-8G7	3	.177	Nylon, Green	Beryllium Copper, Tin	.172	.080				
8007-1G5				Phosphor Bronze, Tin			8011-8G8			Nylon, White							
8000-MG3	1	.185	TEFLON, Natural	Phos. Bronze, Gold	.172	.050	8011-8G9	3	.177	Nylon, Orange	Beryllium Copper, Tin	.172		.090			
8000-MG4				Phosphor Bronze, Tin			8011-8G10			Nylon, Yellow							
8000-MG5	1A	.177	Nylon, Blue	Phos. Bronze, Gold	.172	.050	8011-8G11	3	.177	Nylon, Brown	Beryllium Copper, Tin	.172			.090		
8000-MG6				Phosphor Bronze, Tin			8011-8G12			Nylon, Gray							
8000-MG8	1A	.177	Nylon, White	Phosphor Bronze, Tin	.172	.050	8011-8G13	3	.177	Nylon, Purple	Beryllium Copper, Tin	.172				.090	
8011-8G1				Nylon, Blue			8011-8G6			Nylon, Blue							
8011-8G2	3	.177	Nylon, Black	Beryllium Copper, Tin	.172	.080	8011-8G15	3	.177	Nylon, Black	Beryllium Copper, Tin	.172					.090
8011-8G3							Nylon, Red			8011-8G16							

* Dimension "A" ± .002 (0,05)

** Dimension "B" ± .001 (0,03)

Note: Before ordering, see Cross Reference in Section 15 for equivalent Tyco Electronics Part Number.

Printed Circuit Test Jacks

8041 Series Commercial

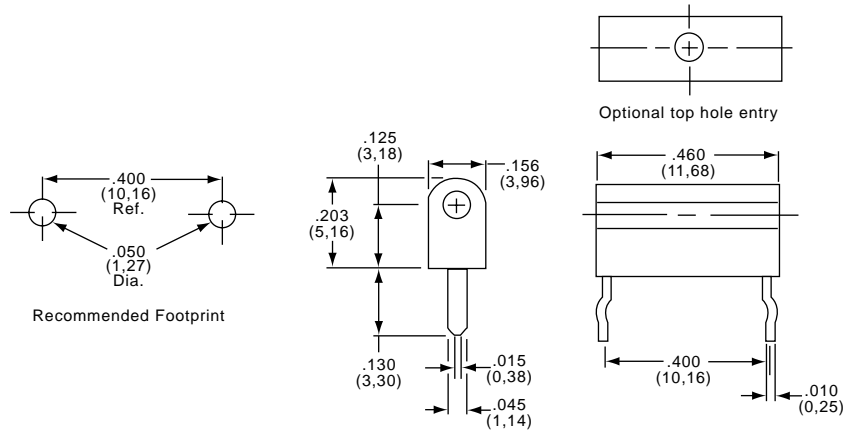

PART NUMBER / STANDARD CONFIGURATIONS

	Side Entry Hole	Top and Side Entry Hole
Insulator Color	Part Number	Part Number
White	8041-1G9	8041-1G9-1
Red	8041-1G4	8041-1G4-1
Black	8041-1G6	8041-1G6-1
Brown	8041-1G3	8041-1G3-1
Green	8041-1G7	8041-1G7-1
Orange	8041-1G5	8041-1G5-1
Blue	8041-1G8	8041-1G8-1
Yellow	8041-1G2	8041-1G2-1
Gray	8041-1G10	8041-1G10-1
Violet	8041-1G11	8041-1G11-1

Note: Before ordering, see Cross Reference in Section 15 for equivalent Tyco Electronics Part Number.

Courtesy of Steven Engineering, Inc. • 230 Ryan Way, South San Francisco, CA, 94080-6370 • Main Office: (650) 588-9200 • Outside Local Area: (800) 258-9200 • www.stevenengineering.com

Micro-Miniature Test Jacks

8046 Series Commercial

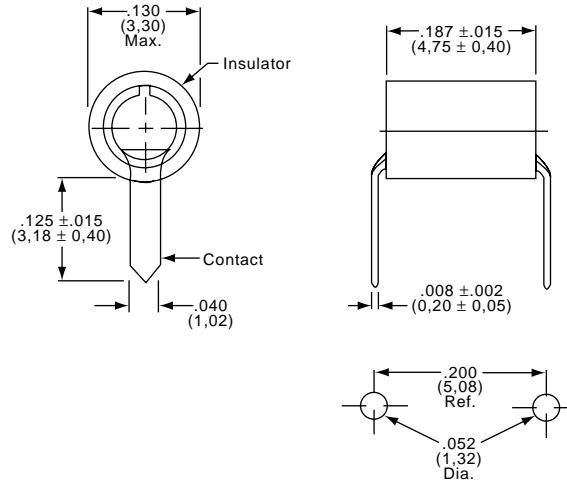

PART NUMBER / STANDARD CONFIGURATIONS

40 Micro-inches Gold	Insulator Color
8046-1G1	Natural
8046-1G2	Yellow
8046-1G3	Brown
8046-1G4	Red
8046-1G5	Orange
8046-1G6	Black
8046-1G7	Green
8046-1G8	Blue
8046-1G9	Gray
8046-1G10	Violet
8046-1G11	White

Note: Before ordering, see Cross Reference in Section 15 for equivalent Tyco Electronics Part Number.