

ACTUAL SIZE

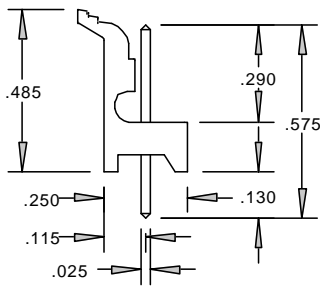

VERTICAL

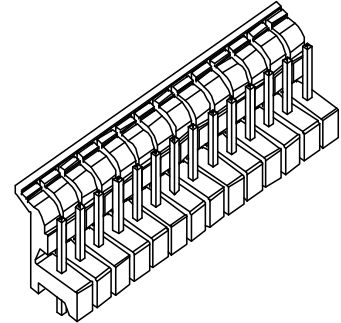
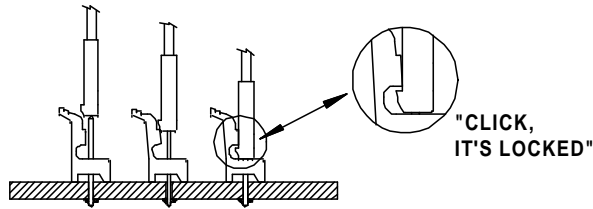
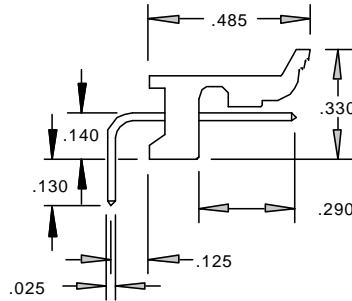
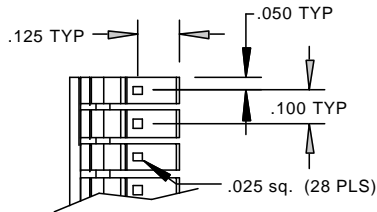

HORIZONTAL

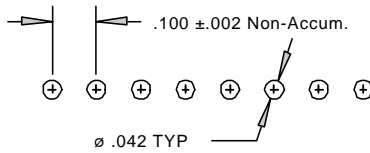

PCB HOLE PATTERN LAYOUT

ORDERING CODES

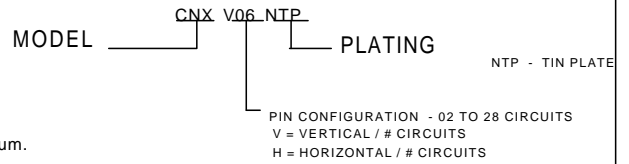

U.S. PAT. PEND.

NOTES:

1. Material: Thermoplastic - (balck) U.L. 94 V2
Pins - Brass .025" square tin plate
on .100" centers.
2. Mates with VCC locking header connector
P/N 450 30X or equal.

REVISIONS			
NO	DESCRIPTION	DATE	BY
1			
2			
3			
4			
5			

CONXRITE® PLRTY LOCKING HEADER

VCC VISUAL COMMUNICATIONS COMPANY, INC.
7920-F Arjons Drive San Diego, California 92126 U.S.A.
Phone (858) 549-6900 Fax (858) 549-3520 e-mail vocsales@vccite.com

TOLERANCES	SCALE	N/A	DATE	03/30/98	DRAWING NO.
DECIMAL ±.010	DIAMETER	.003 Max	DRAWN BY	JMS	
ANGLE ± 30'	RADI	.008 TIR	CHK'D		