

Pass & Seymour



# Industrial Spec Grade Turnlok® Locking Devices Power Interrupting Devices

2 Pole, 3 Wire 20A, 125V Hospital Use

2 Pole, 3 Wire 20A, 125V

2 Pole, 3 Wire 20A, 125V; 10A, 250VDC, 480VAC

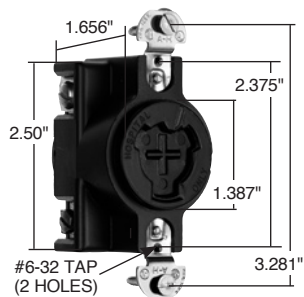

23000HG

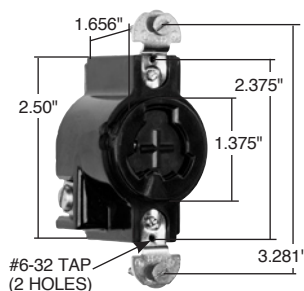

23030

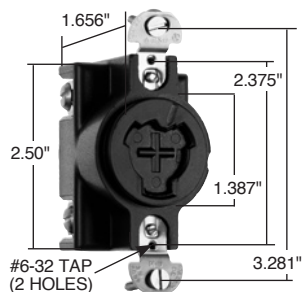

23000

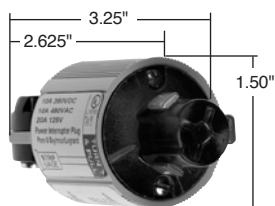

23005N



23056N  
23035N



23002N



23054N

Catalog Number	Rating		Description	Cord Diameter	3rd Party Compliance
	A.	V.			UL UL498
<b>Receptacles</b>					
23000HG	20	125	Hospital Use, Non-Metallic		•
23050	20	125	Hospital Use, Black Bakelite		•
23030	20	125	Non-Metallic		•
23000G	20	125;	Grounding, Non-Metallic		•
	10	250VDC, 480VAC			
23000	20	125;	Non-Grounding, Non-Metallic		•
	10	250VDC, 480VAC			
<b>Connectors</b>					
23054N	20	125	Hospital Use, Non-Metallic	.250"-.656"	•
23002N	20	125;	Non-Metallic	.250"-.656"	•
	10	250VDC, 480VAC			
<b>Plugs</b>					
23056N	20	125	Hospital Use, Non-Metallic	.250"-.656"	•
23035N	20	125	Non-Metallic	.250"-.656"	•
23005N	20	125;	Non-Metallic	.250"-.656"	•
	10	250VDC, 480VAC			

Catalog Number	Description
<b>Accessories</b>	
PSLD	Lockout Device
23007	Aluminum Receptacle Cover with Gasket

# Industrial Spec Grade Turnlok® Locking Devices Power Interrupting Devices

3 Pole, 4 Wire 30A, 480V  
3 Pole, 4 Wire 30A, 600VAC; 20A, 250VDC  
3 Pole, 4 Wire 60A, 600V

Pass & Seymour



Turnlok® Locking Devices

Power Interrupting Devices

Catalog Number	Rating A. V.	Description	Cord Diameter	3rd Party Compliance
				UL UL498
<b>Receptacles</b>				
20443N	30 480	Non-Metallic		•
20403N	30, 600VAC; 20, 250VDC	Non-Metallic		•
21420	30, 600VAC; 20, 250VDC	Angled, 3/4" Tap for Conduit, Die-Cast		•
26420	60 600	Die-Cast with Lift Lid Enclosure		•
<b>Connectors</b>				
20444N	30 480	Non-Metallic	.400"-1.062"	
20414	30, 600VAC; 20, 250VDC	Metallic	.562"-1.000"	
20414N	30, 600VAC; 20, 250VDC	Non-Metallic	.400"-1.062"	•
21414	30, 600VAC; 20, 250VDC	Metallic with Rubber Cord Grip	.360"-0.484"	
26414	60 600	Metallic	.750"-1.250"	•
26427	60 600	Metallic	.750"-1.250"	•
<b>Plugs</b>				
20445N	30 480	Non-Metallic	.400"-1.062"	
20415	30, 600VAC; 20, 250VDC	Metallic	.562"-1.000"	
20415N	30, 600VAC; 20, 250VDC	Non-Metallic	.400"-1.062"	
21415	30, 600VAC; 20, 250VDC	Metallic with Rubber Cord Grip	.360"-0.484"	
21426	30, 600VAC; 20, 250VDC	Metallic with Rubber Cord Grip	.484"-0.750"	
21426S	30, 600VAC; 20, 250VDC	Metallic with Tab with Rubber Cord Grip	.484"-0.750"	
26415	60 600	Metallic	.750"-1.250"	•
26426	60 600	Metallic	.750"-1.250"	•
<b>Flanged Inlets &amp; Outlets</b>				
20418	30, 600VAC; 20, 250VDC	Inlet, Die-Cast for FS and FD Box		•
26415A	60 600	Inlet, Die-Cast		
26414A	60 600	Outlet, Die-Cast		

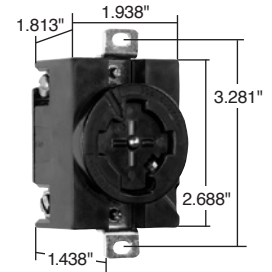

20443N

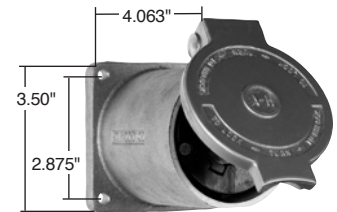

26420

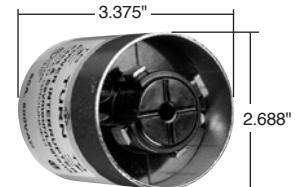

26415

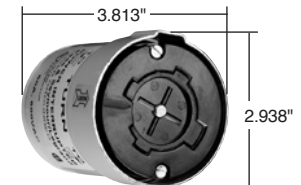

26414

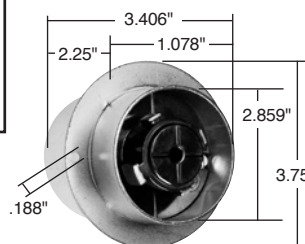

26415A

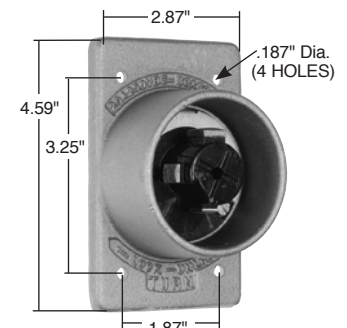

20418

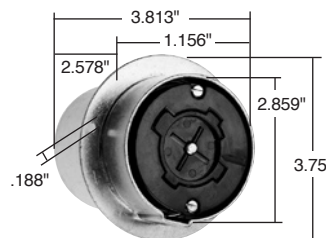

26414A

Catalog Number	Description
<b>Accessories</b>	
WPG1	Weatherproof Cover for 20403N
26400	Box and Plate for 26420
26401	Box only for 26404 Angle Adapter
26402	Mounting Plate only for 26401 Box
26404	45° Angle Adapter
20446N	Red Nylon Cover and Gasket for 20443N
20416N	Nylon Cover and Gasket for 20403N
20417N	Aluminum Cover (No Gasket) for 20403N

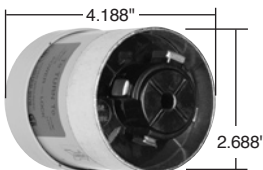

26426

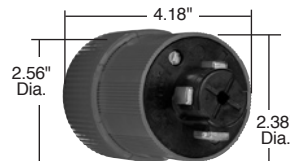

20445N, 20415N

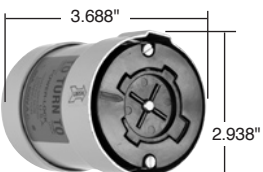

26427

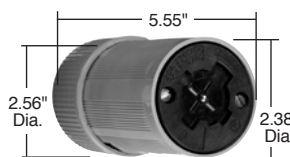

20444N, 20414N

All devices listed on this page conform to NEMA WD-1 and WD-6.



# Industrial Spec Grade Turnlok® Locking Devices Power Interrupting Devices

4 Pole, 5 Wire 30A, 600VAC; 20A 250VDC

4 Pole, 5 Wire 60A, 600V

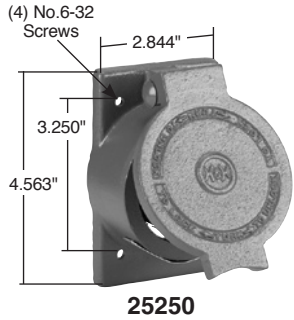

25250

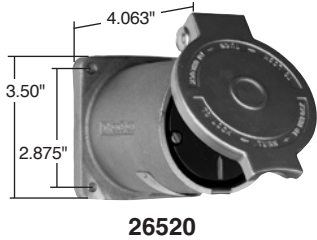

26520

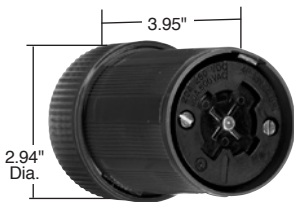

25414N

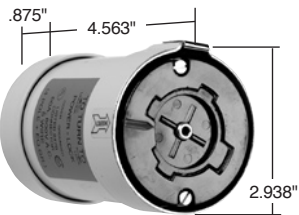

26527

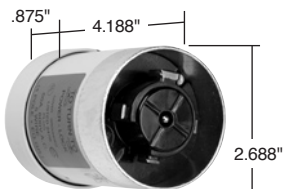

26526

Catalog Number	Rating		Description	Cord Diameter	3rd Party Compliance
	A.	V.			UL UL498
<b>Receptacles</b>					
25250	30	600VAC; 20	250VDC	Die-Cast with Lift Lid Enclosure	
26520	60	600		Die-Cast with Lift Lid Enclosure	•
<b>Connectors</b>					
25414N	30	600VAC; 20	250VDC	Non-Metallic	.625"-1.000" .725"-1.250"
25414	30	600VAC; 20	250VDC	Metallic	.625"-1.000"
26514	60	600		Metallic	.750"-1.250"
26527	60	600		Metallic with Rubber Cord Grip	.750"-1.250"
<b>Plugs</b>					
25415N	30	600VAC; 20	250VDC	Non-Metallic	.625"-1.000" .725"-1.250"
25415	30	600VAC; 20	250VDC	Metallic	.625"-1.000"
26515	60	600		Metallic	.750"-1.250"
26526	60	600		Metallic with Rubber Cord Grip	.750"-1.250"
<b>Flanged Inlets &amp; Outlets</b>					
26515A	60	600		Inlet, Die-Cast	•
26514A	60	600		Outlet, Die-Cast	•

Catalog Number	Description	Catalog Number	Description
<b>Accessories</b>			
26400	Box and Plate for 26520	26404	45° Angle Adapter
26401	Box only for 26404 Angle Adapter	25424	Rubber Cover for 25414 Connector and 25415 Plug
26402	Mounting Plate only for 26401 Box		

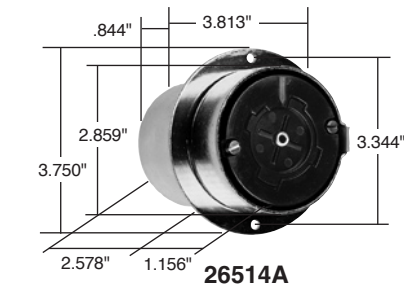

26514A



26515A

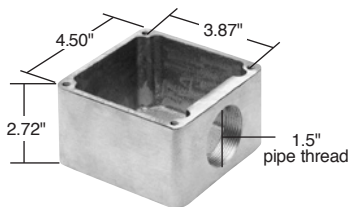

26401

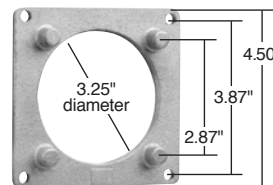

26402

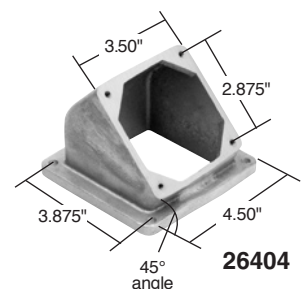

26404

All devices listed on this page conform to NEMA WD-1 and WD-6.