



ALL RIGHTS RESERVED. NO PORTION OF THIS PUBLICATION, WHETHER IN WHOLE OR IN PART CAN BE REPRODUCED WITHOUT THE EXPRESS WRITTEN CONSENT OF SPC TECHNOLOGY.

SPC-F005.DWG

REVISIONS

DOC. NO. SPC-F005 • Effective: 7/8/02 • DCP No: 1398

DCP #	REV	DESCRIPTION	DRAWN	DATE	CHECKD	DATE	APPRVD	DATE
1876	A	RELEASED	EO	04/27/06	TL	05/15/06	HO	05/15/06

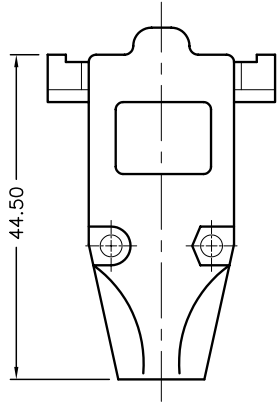
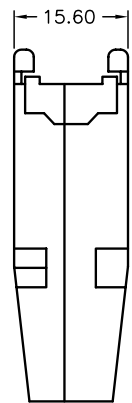
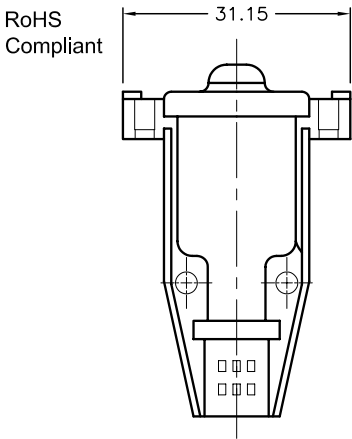

**COVER**

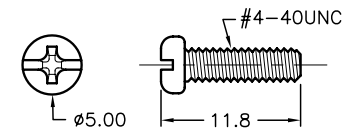

**Screw (2pcs)**

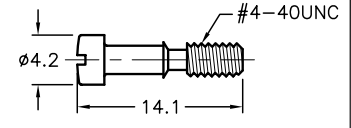

**Captive Screw (2pcs)**

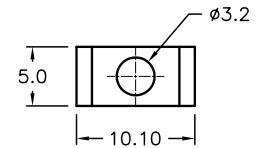

**Saddle Washer (2pcs)**

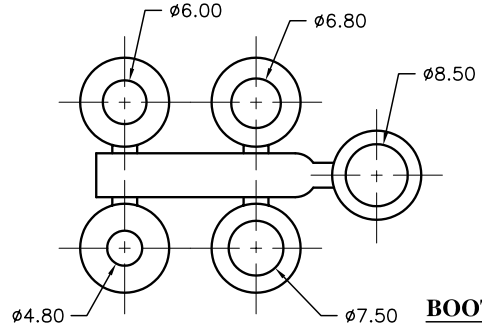

**BOOT**

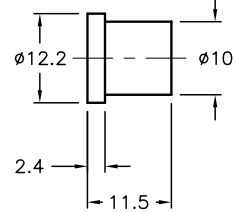

**Material:**

1. Cover: Zinc Alloy, Nickel-plated
2. Hardware: Steel, nickel-plated
3. Boot: PE

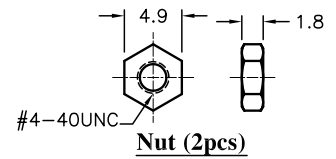

**Nut (2pcs)**

DISCLAIMER:  
ALL STATEMENTS AND TECHNICAL INFORMATION CONTAINED HEREIN ARE BASED UPON INFORMATION AND/OR TESTS WE BELIEVE TO BE ACCURATE AND RELIABLE. SINCE CONDITIONS OF USE ARE BEYOND OUR CONTROL, THE USER SHALL DETERMINE THE SUITABILITY OF THE PRODUCT FOR THE INTENDED USE AND ASSUME ALL RISK AND LIABILITY WHATSOEVER IN CONNECTION THEREWITH.

TOLERANCES:  
Unless Otherwise Specified  
.X ±0.2 [0.008]  
.XX ±0.12 [0.005]

DRAWN BY:	DATE:
EKLAS ODISH	04/27/06
CHECKED BY:	DATE:
THOMAS LEE	05/15/06
APPROVED BY:	DATE:
HISHAM ODISH	05/15/06

DRAWING TITLE: <b>9 PIN STRAIGHT METAL D-SUB COVER, RoHS COMPLIANT</b>			
SIZE	DWG. NO.	ELECTRONIC FILE	REV
A	SPC15468	79K5042.DWG	A
SCALE: NTS	U.O.M.: mm	SHEET: 1 OF 1	