

Electromagnetic Coupling RFID System V600













Non-contact Data Communications System

- Superior environmental resistance.
- Heat-resistant type available (150°C max.).
- High memory capacity of 8 Kbytes for Built-in-battery Data Carriers and 254 bytes for Battery-less Data Carriers.
- Built-in-battery Data Carriers have a battery life detecting function.
- Data of Battery-less Data Carriers can be overwritten 300,000 times at normal temperatures.
- Thin, compact, and low-cost Data Carriers are available.
- Transmission distance of 100 mm max.









Ordering Information





■ Data Carriers

Item	Specifications/Design/Memory capacity	Model
Built-in-battery DCs	Rectangular compact 65 × 40 × 15 mm	8 Kbytes  V600-D8KR12
	Thin rectangular 86 × 54 × 10.3 mm	 V600-D8KR13
	Intermediate-range rectangular 86 × 54 × 20 mm	 V600-D8KR04
Replaceable-battery DCs	Compact 65 × 40 × 5 mm	2 Kbytes  V600-D2KR16
Battery-less DCs	Ultrathin card-type 86 × 54 × 1.5 mm	254 bytes  V600-D23P71
	Thin half-size card-type 50 × 34 × 1.5 mm	 V600-D23P72
	Rectangular 34 × 34 × 3.5 mm	 V600-D23P66N
	Rectangular package with PFA 95 × 36.5 × 6.5 mm	 V600-D23P66SP
	Rectangular compact 32 × 24 × 6 mm	 V600-D23P61
	Round super-compact 8 dia. × 5 mm	 V600-D23P53
	Round compact 12 dia. × 6 mm	 V600-D23P54
	Round super-compact 8 dia. × 5 mm	 V600-D23P55

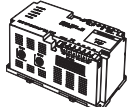
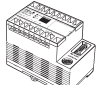

■ R/W Heads

Item		Specifications/Design		Model	
Rectangular type		Dimensions: 100 × 100 × 30 mm	0.5-m cable		V600-H07 (0.5 m)
			2-m cable		V600-H07 (2 m)
			5-m cable		V600-H07 (5 m)
			10-m cable		V600-H07 (10 m)
		Dimensions: 53 × 40 × 23 mm	0.5-m cable		V600-H11 (0.5 m)
			0.5-m cable		V600-H11-R (0.5 m)
			2-m cable		V600-H11 (2 m)
			5-m cable		V600-H11 (5 m)
Cylinder type		Dimensions: 22 dia. × 80 mm	0.5-m cable		V600-H51 (0.5 m)
			2-m cable		V600-H51 (2 m)
			5-m cable		V600-H51 (5 m)
			10-m cable		V600-H51 (10 m)
		Dimensions: 22 dia. × 85 mm	0.5-m cable		V600-H52 (0.5 m)
			2-m cable		V600-H52 (2 m)
			5-m cable		V600-H52 (5 m)
			10-m cable		V600-H52 (10 m)
Separate-amplifier type	Amplifier section	73.8 × 22.6 × 36.5 mm, with 2-m cable			V600-HA51 (2 m)
		73.8 × 22.6 × 36.5 mm, with 5-m cable			V600-HA51 (5 m)
		73.8 × 22.6 × 36.5 mm, with 10-m cable			V600-HA51 (10 m)
	Sensor section	12 dia. × 35 mm deep, with 2-m cable			V600-HS51
		30.5 × 18 × 10 mm, with a 2-m cable			V600-HS61

■ ID Controllers

Item		Specifications/Design		Model	
AC Power Supply		100 to 240 VAC, 50/60 Hz Two R/W Head connectors 200 × 100 × 100 mm	RS-232C host interface		V600-CA1A-V2
			RS-422 host interface		V600-CA2A-V2
			Parallel PNP host interface		V600-CA8A-V2
			Parallel NPN host interface		V600-CA9A-V2
DC Power Supply		24 VDC R/W Head connectors 115 × 68 × 80 mm	RS-232C host interface		V600-CD1D-V3
					24-VDC, 5-VDC 2-system input R/W Head connectors Board type
Handheld Controller		A Battery Charger, Ni-Cd Battery Pack, Battery Case, and Carrying Belt are included.			V600-CB-US-S
AC Power Supply		100 to 240 VAC, 50/60 Hz Relay contact output type		IDSC-C1DR-A	
				150 to 240 VAC, 50/60 Hz Transistor output type	IDSC-C1DT-A
Handheld Reader/Writer		RS-232C Host Interface; use V600-A20 power pack.			V600-CH1D

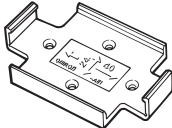
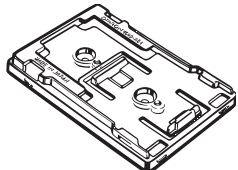
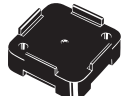
■ Accessories (Order Separately)

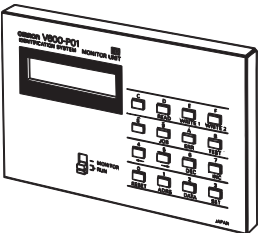
Item	Specifications/Design	Model	
Extension cable for R/W Heads	Standard cable Non-water-resistant connectors	3-m cable	V600-A45
		5-m cable	V600-A44
		10-m cable	V600-A40
		20-m cable	V600-A41
		30-m cable	V600-A42
	Robotic cable Non-water-resistant connectors	3-m cable	V600-A56
		5-m cable	V600-A55
		10-m cable	V600-A50
		20-m cable	V600-A51
		30-m cable	V600-A52
Holder	For the V600-D2KR16 *Mount with M3 flat countersunk head screws (at least two).		V600-A81
	For the V600-D23P71/D23P72 Ultrasonic deposition can be used on the plastic container.		V600-A84
Attachment	For the V600-D23P66N		V600-A86
Lithium battery	For the V600-D2KR16 Commercially available CR2016 battery (includes replacement battery cover seal, and cover)		V600-A82 (5 in each set)
Power pack	For the RFID CH1D Reader/Writer		V600-A20
Monitor Unit	Special Unit for the V600-CA□A-□ Controller		V600-P01

■ RS-232C Cables (Order Separately)

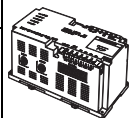
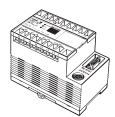



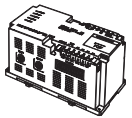
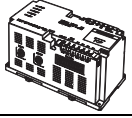
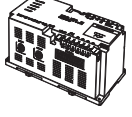



Cable	Compatible ID Controllers	Model
2-m cable	 V600-CA1A-V2	XW2Z-200P
5-m cable		XW2Z-500P
2-m cable	 V600-CD1D-V3 V600-CM1D	XW2Z-200S
5-m cable		XW2Z-500S

■ Connectors for ID Controllers (One Set per Unit)

Connector	Compatible ID Controllers	Model
Connector Plug	 V600-CA2A-V2 V600-CD1D-V3 V600-CM1D	XM2A-0901
Connector Hood		XM2S-0911
Connector Plug	 V600-CA1A-V2	XM2A-2501
Connector Hood		XM2S-2511
Connector Plug	 V600-CA8A-V2 V600-CA9A-V2	MR-50F (Honda Tsushin Kogyo)
Connector Hood		MR-50L (Honda Tsushin Kogyo)





Specifications

■ Battery-less Data Carriers

Description		Ultra-thin Card-type	Ultra-thin Half-size Card-type	Rectangular Compact	Chemical-resistant	Rectangular Compact	Round Super-compact	Round Compact	Round Super-compact
Model		V600-D23P71	V600-D23P72	V600-D23P66N	V600-D23P66SP	V600-D23P61	V600-D23P53	V600-D23P54	V600-D23P55
Item									
Memory capacity		254 bytes							
Memory type		EEPROM (non-volatile memory)							
Transmission distance		Refer to "Transmission Distance Specifications for Battery-less DCs" on page 12.							
Data retention time (after writing data)		10 years		10 years (-40 to 110°C) 1 year (-40 to 150°C)	10 years			10 years (-40 to 110°C) 1 year (-40 to 150°C)	
Number of overwrites (per address) (Refer to separate item for ambient temperature)	Up to 0°C	800,000 times							
	Up to 25°C	400,000 times							
	Up to 60°C	300,000 times							
	Up to 85°C	100,000 times							
Transmission error detection		16-bit CRC in both directions (CRC: Cyclic Redundancy Check)							
Ambient temperature	For data storage	-20 to 110°C		-40 to 150°C (See note.)	-40 to 110°C	-40 to 85°C		-40 to 150°C (See note.)	
	For reading/writing	-10 to 70°C		-20 to 85°C	-20 to 70°C	-25 to 70°C		-25 to 85°C	
Storage temperature		-20 to 110°C		-40 to 150°C (See note.)	-40 to 110°C	-40 to 85°C		-40 to 150°C (See note.)	
Ambient humidity		Operating: 35% to 95%							
Degree of protection		IEC 60529: IP67		IEC 60529: IP68	IEC 60529: IP67	IEC 60529: IP67		IEC 60529: IP67	
Vibration resistance (destruction)		10 to 2,000 Hz, 3.0-mm double amplitude, 300 m/s ² acceleration for 30 min each in 3 directions (90 min total)		10 to 2,000 Hz, 1.5-mm double amplitude, 150 m/s ² acceleration 10 times each in 3 directions (15 min)	10 to 2,000 Hz, 3.0-mm double amplitude, 300 m/s ² acceleration for 30 min each in 3 directions (90 min total)			10 to 2,000 Hz, 1.5-mm double amplitude, 150 m/s ² acceleration 10 times each in 3 directions (15 min)	
Shock resistance (destruction)		1,000 m/s ² 3 times each in 3 directions (18 times total)		500 m/s ² 3 times each in 3 directions (18 times total)	1,000 m/s ² 3 times each in 3 directions (18 times total)			500 m/s ² 3 times each in 3 directions (18 times total)	
Weight		Approx. 15 g	Approx. 5 g	Approx. 6.5 g	Approx. 19 g	Approx. 5.8 g	Approx. 0.4 g	Approx. 1.0 g	Approx. 0.6 g

Note: The 150°C heat resistance was confirmed by leaving the Unit at 150°C for 1,000 continuous hours, and by a thermal shock test consisting of 1,000 -10°C/150°C cycles of 30 min each. No defect was found among the 22 test samples.





■ Built-in-Battery Data Carriers

Description		Rectangular Compact	Rectangular Thin	Rectangular Intermediate Range	Rectangular Compact with Replaceable Battery
Model		V600-D8KR12	V600-D8KR13	V600-D8KR04	V600-D2KR16
Item					
Memory capacity		8 Kbytes			2 Kbytes
Memory type		SRAM (volatile memory)			
Transmission distance		Refer to “Transmission Distance Specifications for Built-in DCs” found in the <i>Specifications</i> section of this data sheet.			
Battery life (See note 1.)		Refer to “Battery Life” found in the Specifications section of this data sheet.			2 years (at 25°C) (See note 2.)
Number of reads/writes		Unlimited			Unlimited (Does not affect battery life)
Transmission error detection		16-bit CRC in both directions (CRC: Cyclic Redundancy Check)			
Ambient temperature	For data storage	-40 to 70°C			-15 to 70°C
	For reading/writing	-25 to 70°C			0 to 50°C
Storage temperature		-40 to 70°C			-15 to 70°C
Ambient humidity		35% to 95%			35% to 85%
Storage humidity		35% to 95%			
Degree of protection		IEC 60529: IP67			IEC 60529: IP50 (dustproof) (See note 3.)
Vibration resistance (destruction)		10 to 500 Hz, 1.0-mm single amplitude, 150 m/s ² acceleration for 11 min each in X, Y, and Z directions			10 to 150 Hz, 0.75-mm single amplitude, 100-m/s ² acceleration for 30 min each in X, Y, and Z directions
Shock resistance (destruction)		1,000 m/s ² 3 times each in X, Y, and Z directions (18 times total)			300 m/s ² 3 times each in X, Y, and Z directions (18 times total)
Weight		Approx. 70 g		Approx. 160 g	Approx. 15 g

Note: 1. A low battery detection function is built-in.

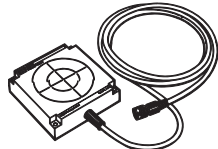

- 2.** The battery life is applicable for batteries used at a temperature of 25°C. For details on the relationship between temperature and battery life, refer to “Temperature and Battery Life,” in this data sheet, found just before the “Precautions” section. The CR2016 is provided as the replacement battery (see “Accessories” in the *Ordering Information* of this data sheet). The Data Carrier is dustproof when the provided battery replacement cover seal is used.

■ Read/Write (R/W) Heads (with Built-in Amplifier)

Model	V600-H07	V600-H11/H11-R	V600-H51	V600-H52
Item				
Oscillation frequency	530 kHz			
Ambient temperature	-25 to 70°C		-10 to 60°C	
Storage temperature	-40 to 85°C		-25 to 75°C	
Ambient humidity	35% to 95%			
Storage humidity	35% to 95%			
Insulation resistance	50 MΩ (at 500 VDC) between cable terminals and case			
Dielectric strength	1,000 VAC, 50/60 Hz for 1 min between cable terminals and case (Leakage current: 1 mA max.)			
Degree of protection	IEC 60529: IP67			
Vibration resistance (destruction)	10 to 500 Hz, 1.0-mm single amplitude, 150 m/s ² acceleration with 3 sweeps of 11 min each in X, Y, and Z directions			
Shock resistance	Destruction: 500 m/s ² 3 times each in X, Y, and Z directions (18 times total)			
Cable length (See note 1.)	Standard lengths of 0.5 m, 2 m, 5 m, and 10 m.			
Wireless transmission error detection	16-bit CRC in both directions (CRC: Cyclic Redundancy Check)			
Indicators	Power: green; transmission: orange			
Weight	Approx. 1 kg (with 10-m cable)	Approx. 650 g (with 10-m cable)		

Note: 1. Extension cables are also available. The maximum cable length is 30.5 m for the V600-H07 and 50.5 m for the V600-H11/H51/H52.
 2. The connectors are not water-resistant.



■ R/W Heads (with Separate Amplifier)

Item	Model	Sensor section		Amplifier section	
		V600-HS51	V600-HS61	V600-HA51	
					
Oscillation frequency	530 kHz		---		
Ambient temperature	-10 to 60°C				
Storage temperature	-25 to 75°C				
Ambient humidity	35% to 95%				
Insulation resistance	50 MΩ (at 500 VDC) between cable terminals and case				
Dielectric strength	1,000 VAC 50/60 Hz for 1 min between cable terminals and case (Leakage current: 1 mA max.)				
Degree of protection	IEC 60529: IP67			IEC 60529: IP66	
Vibration resistance (destruction)	10 to 2,000 Hz, 1.5-mm single amplitude, 300 m/s ² acceleration with 2 sweeps of 15 min each in 3 directions			Installed in panel	10 to 2,000 Hz, 1.5-mm single amplitude, 300-m/s ² acceleration with 2 sweeps of 11 min each in 3 directions
				DIN Track installation	10 to 500 Hz, 1.0-mm single amplitude, 150-m/s ² acceleration with 3 sweeps of 11 min each in 3 directions
Shock resistance (destruction)	1,000 m/s ² 3 times each in 3 directions (18 times total)			500 m/s ² 3 times each in 3 directions (18 times total)	
Cable length	Sensor to amplifier	2 m (fixed)			---
	Amplifier to controller	---			Standard lengths of 2 m, 5 m, and 10 m (See note 1.)
Wireless transmission error detection	16-bit CRC in both directions (CRC: Cyclic Redundancy Check)				
Indicators	---			Power: green; transmission: orange	
Weight	Approx. 70 g (with 2-m cable)			Approx. 650 g (with 10-m cable)	

Note: 1. Extension cables are also available. The maximum cable length is 50 m for the V600-HA51. Extension cables are not available for the V600-HS51/HS61.

2. The connectors are not water-resistant.

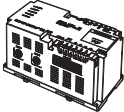
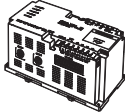
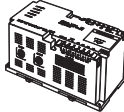
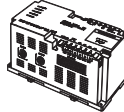
■ ID Controllers

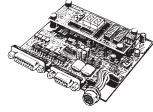
Series Model	V600 Series (Electromagnetic RFID System)					
	V600-CA1A-V2	V600-CA2A-V2	V600-CA8A-V2	V600-CA9A-V2	V600-CD1D-V3	V600-CM1D
Item						
Host interface	RS-232C	RS-422A (Maximum of 16 Units can be connected)	Parallel PNP output	Parallel NPN output	RS-232C	
Possible number of R/W Heads	2				1	
Power supply voltage	100 to 240 VAC, 50/60 Hz				24 VDC	24 VDC, 5 VDC
Acceptable power supply voltage	85 to 264 VAC				20.4 to 26.4 VDC	20.4 to 26.4 VDC 4.5 to 5.5 VDC
Power consumption	35 VA max.				7.2 W max.	24 VDC: 7.2 W max. 5 VDC: 1.5 W max.
Insulation resistance	50 MΩ min. (at 500 VDC) between power terminals and case, between I/O terminals and case, or between the power supply terminals and I/O terminals					
Dielectric strength	1,500 VAC, 50/60 Hz for 1 min between the points listed above; Leakage current: 10 mA max.				1,000 VAC, 50/60 Hz for 1 min between the points listed above; Leakage current: 10 mA max.	
Noise immunity	1,500-V (p-p) pulses of 100-ns to 1-μs pulse width with a 1-ns rise time					
Vibration resistance	Destruction	10 to 150 Hz, 0.3-mm double amplitude for 32 min each in X, Y, and Z directions				
	Malfunction	10 to 150 Hz, 0.2-mm double amplitude for 32 min each in X, Y, and Z directions				
Shock resistance	Destruction: 200 m/s ² 3 times each in X, Y, and Z directions (18 times total)					
Ambient temperature	-10 to 55°C					0 to 50°C
Ambient humidity	35% to 85% (with no condensation)					
Operating conditions	No corrosive gases					
Storage temperature	-25 to 65°C					-15 to 70°C
Memory back-up	A capacitor backs up the most recent error data and statistical error data for up to 20 days (at 25°C) after a power interruption.				Memory backup is not available. Error details, however, can be read from the personal computer when the power is turned ON.	
Diagnostic functions	Checks for CPU errors, memory errors, power interruptions, and transmission errors					
Ground	Ground to 100 Ω or less.					
Degree of protection	IEC 60529: IP30 (panel mounted)					
Weight	Approx. 890 g	Approx. 930 g	Approx. 960 g	Approx. 360 g	Approx. 180 g	

■ Monitor Unit

V600-P01 (for use with V600-CA□A Controllers)

The Monitor Unit is a monitoring device that can be mounted to an ID Controller. It can be used to test communications between the R/W Head and Data Carrier when the RFID System is started up, check the data in Data Carriers, and read error information or statistical error information.

The specifications conform to those of the ID Controller, except the operating temperature range is 0°C to 40°C.

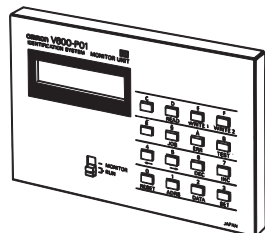

■ Handheld ID Controllers

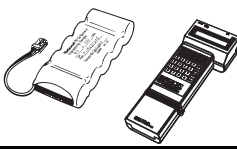
Item	Model	V600-CB-US-S
		
Power supply		Built-in nickel-cadmium batteries (6 VDC) or 9-V alkaline batteries (9 VDC) (See note.)
Power consumption		700 mA max.
Continuous operating time (See note.)		3 hrs min. when using the built-in nickel-cadmium batteries; 1.5 hrs min. when using the alkaline batteries
Automatic power-saver		The power is turned OFF automatically if a key input or response is not received in 10 min.
Automatic command cancellation		A command will be cancelled automatically if a response is not received from a Data Carrier within 2 min.
Low battery indicator		This display appears when the battery voltage falls below the minimum voltage required for operation.
User memory		32 Kbytes (Data will be retained for at least 24 hrs after batteries are removed.)
Vibration resistance		Destruction: 10 to 150 Hz, 0.3-mm double amplitude for 32 min each in X, Y, and Z directions
Shock resistance		Destruction: 200 m/s ² 3 times each in X, Y, and Z directions (18 times total)
Ambient temperature		0 to 45°C
Ambient humidity		35% to 85% (with no condensation)
Operating conditions		No corrosive gases
Storage temperature		-25 to 60°C (excluding the battery pack)
Degree of protection		IEC 60529: IP30
Weight		680 g max. (including the battery pack)

Note: The continuous operating time is for new, fully charged nickel cadmium batteries or new alkaline batteries used at room temperature. Overseas specifications (with UL-listed Battery Charger) also available.

V600-CB-US-S Configuration

Item	Description	Model
Handheld ID Controller	Controller	V600-CB-US
Battery Charger	Accessory	V600-A14
Battery Case	Accessory (for alkaline batteries)	V600-A11
Ni-Cd Battery Pack	Accessory (built-in to ID Controller)	V600-A12
Carrying Belt	Accessory	V600-A13

Handheld V600-CH1D Wand

Power supply	5 VDC from AC adapter
Permissible power supply voltage	5 VDC ±5%
Current consumption	200 mA max. (See Note 1.)
Insulation resistance	50 MΩ min. (at 500 VDC) between cable terminals and case
Dielectric strength	1,000 VAC, 50/60 Hz for 1 min (1 mA max.) between cable terminals and case
Noise immunity	Power supply line: 1,200 Vp-p I/O line: 800 Vp-p
Vibration resistance	Destruction: 10 to 150 Hz, 0.3-mm single amplitude, with 4 sweeps of 8 min each in 3 directions
Shock resistance	Destruction: 294 m/S ² 3 (approx. 20G) times each in 3 directions
Ambient temperature	Operating: -10 to 55°C with no icing; storage: -25 to 65°C with no icing
Ambient humidity	35% to 85% (with no condensation)
Operating conditions	No corrosive gases
Enclosure ratings	IEC: IP63, JIS: IPX3 (waterproof) See note 2.
Material	Case: ABS resin; nameplate: PET resin
Cable length	2.5 m
Weight	Approx. 180 g (including the connector and cable)

Note: 1. This figure is for idling or stand-by. The rush current must be 250 mA max.







2. This does not include the connector section. The main unit is not resistant to chemicals or oils.

■ IDSC Series



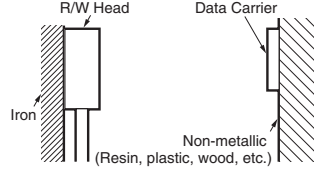



Item	Series	IDSC Series IDSC-C1DR-A IDSC-C1DT-A 
	Model	
Host interface		RS-232C
Possible number of R/W Heads		1
Power supply voltage		100 to 240 VAC, 50/60 Hz
Acceptable power supply voltage		85 to 264 VAC
Power consumption		60 VA max.
Insulation resistance		20 Ω min. (at 500 VDC) between all Power Supply Unit AC external terminals and ground terminals
Dielectric strength		2,300 VAC, 50/60 Hz for 1 min between Power Supply Unit AC external terminals and ground terminals Leakage current: 10 mA max.
Noise immunity		1,500-V (p-p) pulses of 100-ns to 1-μs pulse width with a 1-ns rise time
Vibration resistance		10 to 57 Hz, 0.075-mm amplitude, 57 to 150 Hz, 9.8 m/s ² acceleration for 80 min each in X, Y, and Z directions
Shock resistance		150 m/s ² 3 times each in X, Y, and Z directions
Ambient temperature		0 to 55°C
Ambient humidity		10% to 90% (with no condensation)
Operating conditions		No corrosive gases
Storage temperature		-20 to 75°C (excluding the battery pack)
Memory back-up		The battery life is 5 years regardless of whether an RTC is provided. The period that data is retained after a power interruption depends on the ambient temperature. Replace the battery within one week of the battery low indicator flashing.
Diagnostic functions		Checks for CPU errors, memory errors, power interruptions, and transmission errors
Ground		Ground to 100 Ω or less.
Construction		Installed in panel
Weight		Approx. 1,500 g

Note: Refer to the applicable ID Controller Operation Manual (Cat. No. W250) for details.

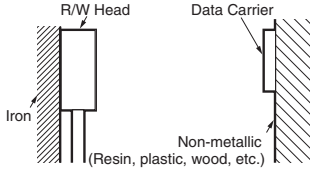

■ Transmission Distance Specifications for Battery-less DCs

Recommended combinations		Installation		Controller mode	Transmission distance	Condition for DC and R/W head installation
Data Carrier	R/W Head		Read/Write distance			
		Stationary	Read/Write distance	Irrelevant	10 to 70 mm (max. axial offset ±10 mm)	<p>These Data Carriers are for installation on non-metallic surfaces only.</p>  <p>Data transmission will be impossible if the DC is installed directly on a metal surface. Refer to the <i>V600 R/W Heads and EEPROM Data Carriers Operation Manual</i> (Cat. No. Z128) for details.</p>
		Moving			30 to 60 mm (max. axial offset ±10 mm)	
		Stationary	Read/Write distance	Irrelevant	5 to 40 mm (max. axial offset ±10 mm)	
		Moving			15 to 40 mm (max. axial offset ±10 mm)	
		Stationary	Read/Write distance	Irrelevant	5 to 30 mm (max. axial offset ±10 mm)	
		Moving			15 to 30 mm (max. axial offset ±10 mm)	







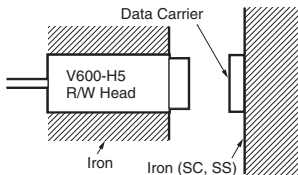
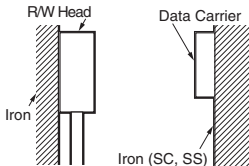
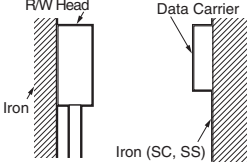

- Note:**
1. The transmission distance/transmission time priority mode setting can be made using the lower-level transmission mode setting switch or memory switch only with a Serial-interface Controller or ID Sensor Unit.
 2. With Parallel-interface Controllers, the mode setting is always transmission distance priority.
 3. The specifications take fluctuations in ambient temperature and slight differences between products into account.

Recommended combinations		Installation		Controller mode	Transmission distance	Condition for DC and R/W head installation
Data Carrier	R/W Head					
		Stationary	Read distance	Transmission distance priority	5 to 45 mm (max. axial offset ±10 mm)	 <p>Data transmission will be impossible if the DC is installed directly on a metal surface. Refer to the <i>V600 R/W Heads and EEPROM Data Carriers Operation Manual</i> (Cat. No. Z128) for details.</p>
				Transmission time priority	5 to 35 mm (max. axial offset ±10 mm)	
			Write distance	Irrelevant	5 to 35 mm (max. axial offset ±10 mm)	
		Moving	Read distance	Transmission distance priority	25 to 40 mm (max. axial offset ±10 mm)	
				Transmission time priority	25 to 30 mm (max. axial offset ±10 mm)	
			Write distance	Irrelevant	25 to 30 mm (max. axial offset ±10 mm)	
		Stationary	Read distance	Transmission distance priority	5 to 30 mm (max. axial offset ±10 mm)	
				Transmission time priority	5 to 25 mm (max. axial offset ±10 mm)	
			Write distance	Irrelevant	5 to 25 mm (max. axial offset ±10 mm)	
		Moving	Read distance	Transmission distance priority	15 to 25 mm (max. axial offset ±10 mm)	
				Transmission time priority	15 to 20 mm (max. axial offset ±10 mm)	
			Write distance	Irrelevant	15 to 20 mm (max. axial offset ±10 mm)	
		Stationary	Read distance	Transmission distance priority	5 to 40 mm (max. axial offset ±10 mm)	
				Transmission time priority	5 to 30 mm (max. axial offset ±10 mm)	
			Write distance	Irrelevant	5 to 30 mm (max. axial offset ±10 mm)	
		Moving	Read distance	Transmission distance priority	20 to 40 mm (max. axial offset ±10 mm)	
				Transmission time priority	20 to 30 mm (max. axial offset ±10 mm)	
			Write distance	Irrelevant	20 to 30 mm (max. axial offset ±10 mm)	
		Stationary	Read distance	Transmission distance priority	5 to 25 mm (max. axial offset ±10 mm)	
				Transmission time priority	5 to 20 mm (max. axial offset ±10 mm)	
			Write distance	Irrelevant	5 to 20 mm (max. axial offset ±10 mm)	
		Moving	Read distance	Transmission distance priority	10 to 25 mm (max. axial offset ±10 mm)	
				Transmission time priority	10 to 20 mm (max. axial offset ±10 mm)	
			Write distance	Irrelevant	10 to 20 mm (max. axial offset ±10 mm)	

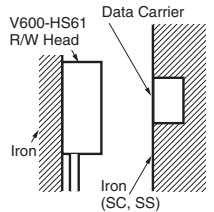
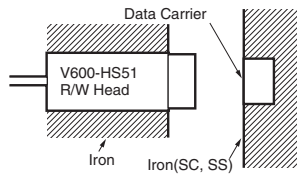
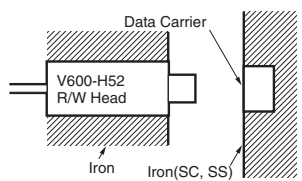



- Note:**
1. The transmission distance/transmission time priority mode setting can be made using the lower-level transmission mode setting switch or memory switch only with a Serial-interface Controller or ID Sensor Unit.
 2. With Parallel-interface Controllers, the mode setting is always transmission distance priority.
 3. The specifications take fluctuations in ambient temperature and slight differences between products into account.

Recommended combinations		Installation		Controller mode	Transmission distance	Condition for DC and R/W head installation	
Data Carrier	R/W Head						
		Stationary	Read distance	Transmission distance priority	2 to 19 mm (max. axial offset ±10 mm)	<p>These Data Carriers can be installed on metallic surfaces.</p>  	
				Transmission time priority	2 to 16 mm (max. axial offset ±10 mm)		
			Write distance	Irrelevant	2 to 16 mm (max. axial offset ±10 mm)		
		Moving	Read distance	Transmission distance priority	12 to 19 mm (max. axial offset ±10 mm)		
				Transmission time priority	13 to 16 mm (max. axial offset ±10 mm)		
			Write distance	Irrelevant	12 to 16 mm (max. axial offset ±10 mm)		
		Stationary	Read distance	Transmission distance priority	1 to 16 mm (max. axial offset ±10 mm)	<p>The listed transmission distances also apply for installation on non-metallic surfaces. Refer to the <i>V600 R/W Heads and EEPROM Data Carriers Operation Manual</i> (Cat. No. Z128) for details.</p>	
				Transmission time priority	1 to 14 mm (max. axial offset ±10 mm)		
				Write distance	Irrelevant		1 to 14 mm (max. axial offset ±10 mm)
			Moving	Read distance	Transmission distance priority		7 to 16 mm (max. axial offset ±10 mm)
					Transmission time priority		7 to 14 mm (max. axial offset ±10 mm)
				Write distance	Irrelevant		7 to 14 mm (max. axial offset ±10 mm)

- Note:**
1. The transmission distance/transmission time priority mode setting can be made using the lower-level transmission mode setting switch or memory switch only with a Serial-interface Controller or ID Sensor Unit.
 2. With Parallel-interface Controllers, the mode setting is always transmission distance priority.
 3. The specifications take fluctuations in ambient temperature and slight differences between products into account.



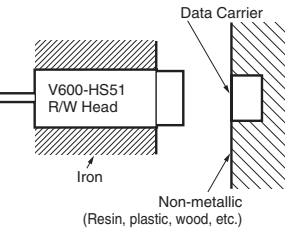

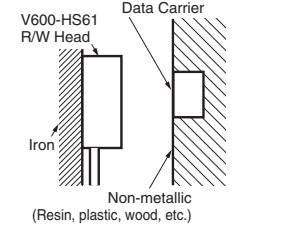
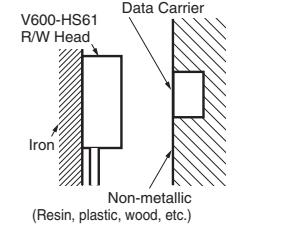
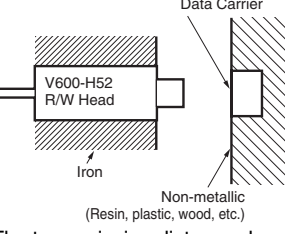



Recommended combinations		Installation		Controller mode	Transmission distance		Condition for DC and R/W head installation
Data Carrier	R/W Head						
V600-D23P53 	V600-HS51 (See note 4.) 	Stationary	Read distance	Transmission distance priority	0.5 to 4.0 mm (max. axial offset ±2 mm)	0.5 to 4.5 mm (max. axial offset ±1 mm)	These Data Carriers are for flush mounting in metallic bases only.   
				Transmission time priority	0.5 to 3.0 mm (max. axial offset ±2 mm)	0.5 to 3.5 mm (max. axial offset ±1 mm)	
			Write distance	Irrelevant		0.5 to 3.0 mm (max. axial offset ±2 mm)	
	V600-HS61 (See note 4.) 			Read distance	Transmission distance priority	0.5 to 4.0 mm (max. axial offset ±2 mm)	
			Transmission time priority		0.5 to 3.0 mm (max. axial offset ±2 mm)	0.5 to 3.5 mm (max. axial offset ±1 mm)	
			Write distance	Irrelevant		0.5 to 3.0 mm (max. axial offset ±2 mm)	
	V600-H52 	Read distance	Transmission distance priority	0.5 to 4.0 mm (max. axial offset ±2 mm)	0.5 to 4.5 mm (max. axial offset ±1 mm)		
			Transmission time priority	0.5 to 3.0 mm (max. axial offset ±2 mm)	0.5 to 3.5 mm (max. axial offset ±1 mm)		
		Write distance	Irrelevant		0.5 to 3.0 mm (max. axial offset ±2 mm)	0.5 to 3.5 mm (max. axial offset ±1 mm)	
V600-D23P54 	V600-HS51 (See note 4.) 	Stationary	Read distance	Transmission distance priority	0.5 to 6.0 mm (max. axial offset ±2 mm)	0.5 to 6.5 mm (max. axial offset ±1 mm)	The listed transmission distances also apply for installation on non-metallic surfaces. Refer to the <i>V600 R/W Heads and EEPROM Data Carriers Operation Manual</i> (Cat. No. Z128) for details.
				Transmission time priority	0.5 to 5.5 mm (max. axial offset ±2 mm)	0.5 to 6.0 mm (max. axial offset ±1 mm)	
			Write distance	Irrelevant		0.5 to 5.0 mm (max. axial offset ±2 mm)	
	V600-HS61 (See note 4.) 			Read distance	Transmission distance priority	0.5 to 6.5 mm (max. axial offset ±2 mm)	
			Transmission time priority		0.5 to 5.5 mm (max. axial offset ±2 mm)	0.5 to 6.0 mm (max. axial offset ±1 mm)	
			Write distance	Irrelevant		0.5 to 5.5 mm (max. axial offset ±2 mm)	
	V600-H52 	Read distance	Transmission distance priority	0.5 to 6.5 mm (max. axial offset ±2 mm)	0.5 to 7.0 mm (max. axial offset ±1 mm)		
			Transmission time priority	0.5 to 5.5 mm (max. axial offset ±2 mm)	0.5 to 6.0 mm (max. axial offset ±1 mm)		
		Write distance	Irrelevant		0.5 to 5.5 mm (max. axial offset ±2 mm)	0.5 to 6.0 mm (max. axial offset ±1 mm)	



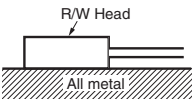
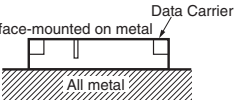

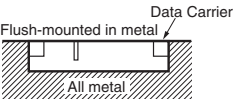
- Note:**
1. The transmission distance/transmission time priority mode setting can be made using the lower-level transmission mode setting switch or memory switch only with a Serial-interface Controller or ID Sensor Unit.
 2. With Parallel-interface Controllers, the mode setting is always transmission distance priority.
 3. The specifications take fluctuations in ambient temperature and slight differences between products into account.
 4. This is the transmission distance when using the V600-HS□1 and V600-HA51 combination.

Recommended combinations		Installation		Controller mode	Transmission distance	Condition for DC and R/W head installation	
Data Carrier	R/W Head						
V600-D23P55 	V600-HS51 (See note 4.) 	Stationary	Read distance	Transmission distance priority	0.5 to 6.5 mm (max. axial offset ±2 mm)	These Data Carriers are for flush mounting in non-metallic bases only.  V600-HS51 R/W Head Iron Non-metallic (Resin, plastic, wood, etc.)	
				Transmission time priority	0.5 to 6.0 mm (max. axial offset ±2 mm)		
			Write distance	Transmission distance priority	0.5 to 6.5 mm (max. axial offset ±2 mm)		
				Transmission time priority	0.5 to 6.0 mm (max. axial offset ±2 mm)		
	V600-HS61 (See note 4.) 	Stationary	Read distance	Transmission distance priority	0.5 to 7.0 mm (max. axial offset ±2 mm)		 V600-HS61 R/W Head Iron Non-metallic (Resin, plastic, wood, etc.)
				Transmission time priority	0.5 to 6.0 mm (max. axial offset ±2 mm)		
Write distance			Transmission distance priority	0.5 to 7.0 mm (max. axial offset ±2 mm)			
			Transmission time priority	0.5 to 6.0 mm (max. axial offset ±2 mm)			
V600-H52 	Stationary	Read distance	Transmission distance priority	0.5 to 9.0 mm (max. axial offset ±2 mm)	 V600-H52 R/W Head Iron Non-metallic (Resin, plastic, wood, etc.)		
			Transmission time priority	0.5 to 8.5 mm (max. axial offset ±2 mm)			
		Write distance	Transmission distance priority	0.5 to 8.5 mm (max. axial offset ±2 mm)			
			Transmission time priority	0.5 to 8.5 mm (max. axial offset ±2 mm)			

- Note:**
1. The transmission distance/transmission time priority mode setting can be made using the lower-level transmission mode setting switch or memory switch only with a Serial-interface Controller or ID Sensor Unit.
 2. With Parallel-interface Controllers, the mode setting is always transmission distance priority.
 3. The specifications take fluctuations in ambient temperature and slight differences between products into account.
 4. This is the transmission distance when using the V600-HS□1 and V600-HA51 combination.

■ Transmission Distance Specifications for Built-in-Battery DCs

Recommended combinations		Installation		Controller mode	Transmission distance	Condition for DC and R/W head installation		
Data Carrier	R/W Head							
		Stationary	Flush-mounted in metal	Irrelevant	10 to 50 mm (max. axial offset ±10 mm)			
			Surface-mounted on metal		10 to 60 mm (max. axial offset ±10 mm)			
		Moving	Flush-mounted in metal		25 to 50 mm (max. axial offset ±10 mm)			
			Surface-mounted on metal		25 to 60 mm (max. axial offset ±10 mm)			
		Stationary	Flush-mounted in metal		Irrelevant	5 to 40 mm (max. axial offset ±10 mm)		
			Surface-mounted on metal			5 to 45 mm (max. axial offset ±10 mm)		
		Moving	Flush-mounted in metal			25 to 40 mm (max. axial offset ±10 mm)		<p>The listed transmission distances also apply for installation on non-metallic surfaces. Refer to the <i>V600 R/W Heads and SRAM Data Carriers Operation Manual</i> (Cat. No. Z127) for details.</p>
			Surface-mounted on metal			25 to 45 mm (max. axial offset ±10 mm)		
		Stationary	Flush-mounted in metal	Irrelevant	10 to 30 mm (max. axial offset ±10 mm)			
			Surface-mounted on metal		10 to 35 mm (max. axial offset ±10 mm)			
		Moving	Flush-mounted in metal		20 to 30 mm (max. axial offset ±10 mm)			
			Surface-mounted on metal		20 to 35 mm (max. axial offset ±10 mm)			
		Stationary	Flush-mounted in metal		Irrelevant		10 to 30 mm (max. axial offset ±10 mm)	
			Surface-mounted on metal					
		Moving	Flush-mounted in metal				15 to 30 mm (max. axial offset ±10 mm)	
			Surface-mounted on metal					

Recommended combinations		Installation		Controller mode	Transmission distance	Condition for DC and R/W head installation	
Data Carrier	R/W Head						
V600-D8KR04 (unsealed) 	V600-H07 	Stationary	Flush-mounted in metal	Irrelevant	See note1.	The listed transmission distances also apply for installation on non-metallic surfaces. Refer to the <i>V600 R/W Heads and SRAM Data Carriers Operation Manual</i> (Cat. No. Z127) for details.	
			Surface-mounted on metal		10 to 100 mm (max. axial offset ± 10 mm)		
		Moving	Flush-mounted in metal		See note1.		
			Surface-mounted on metal		50 to 100 mm (max. axial offset ± 10 mm)		
	V600-H11 	Stationary	Flush-mounted in metal		Irrelevant		See note1.
			Surface-mounted on metal				10 to 65 mm (max. axial offset ± 10 mm)
Moving	Flush-mounted in metal	See note1.					
	Surface-mounted on metal	30 to 65 mm (max. axial offset ± 10 mm)					
V600-D2KR16 	V600-H11 	Stationary	Flush-mounted in metal	Irrelevant		2 to 15 mm (max. axial offset ± 10 mm) (See note 2.)	
			Surface-mounted on metal			2 to 15 mm (max. axial offset ± 10 mm)	
		Moving	Flush-mounted in metal		6 to 15 mm (max. axial offset ± 10 mm) See note 2.)		
			Surface-mounted on metal		10 to 15 mm (max. axial offset ± 10 mm)		

Note: 1. When Data Carriers are flush-mounted in metal, the read/write distance will depend on the distance (x) between the side of the DC and the metal surface.

2. Use the following method for flush mounting into a metallic base.

Refer to the *V600 R/W Heads and SRAM Data Carriers Operation Manual* (Cat. No. Z127) for details.

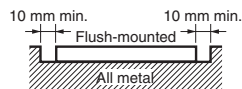
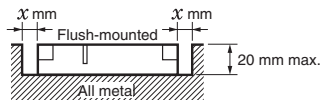

Combined with V600-H07

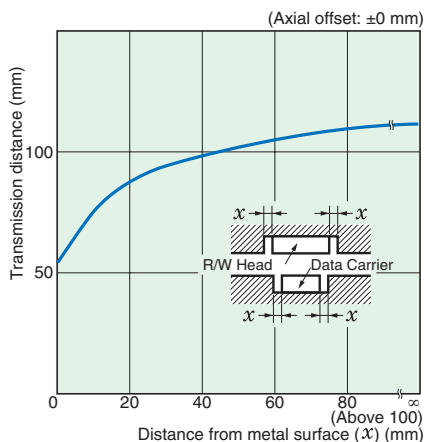

Combined with V600-H11

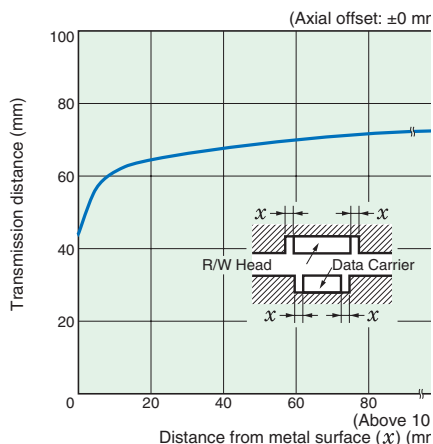

Characteristic Data (Typical)

Transmission Range

Note: The values shown in the following graphs are in millimeters. Refer to the previous six pages for details on Data Carrier and R/W Head mounting conditions.

Battery-less Compact DCs

V600-D23P71 & V600-H07

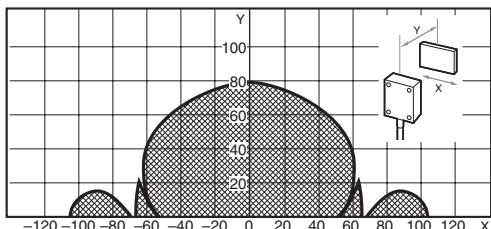

V600-D23P71 & V600-H11

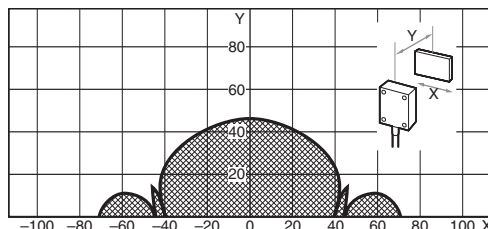

V600-D23P72 & V600-H07

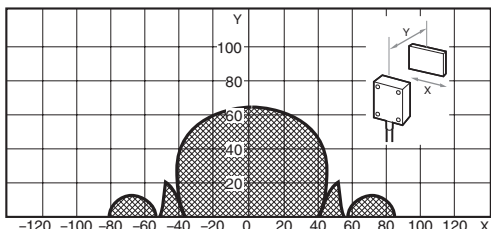

V600-D23P72 & V600-H11

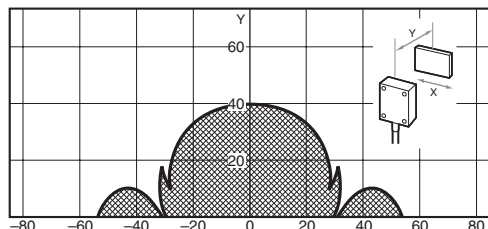

V600-D23P66N & V600-H07

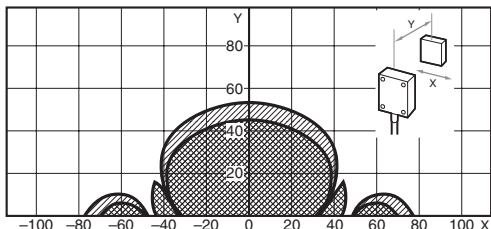

V600-D23P66N & V600-H11

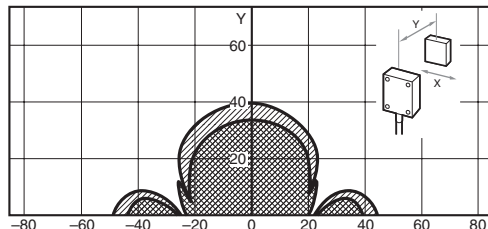

V600-D23P66SP & V600-H07

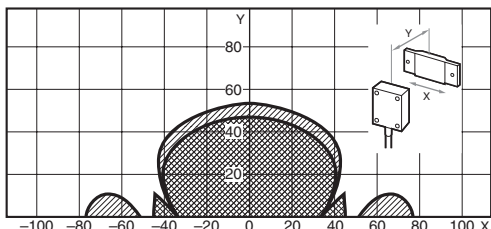

V600-D23P66SP & V600-H11

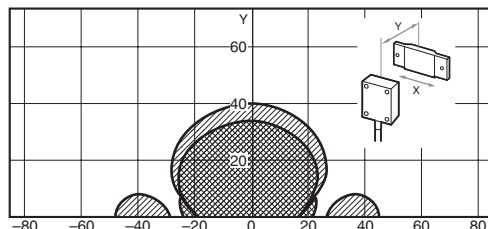

V600-D23P61 & V600-H11

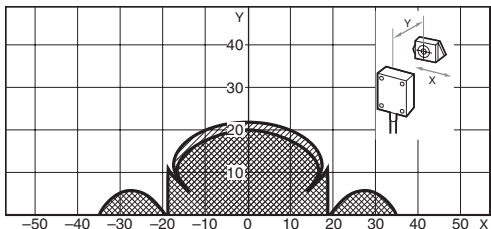

V600-D23P61 & V600-H51

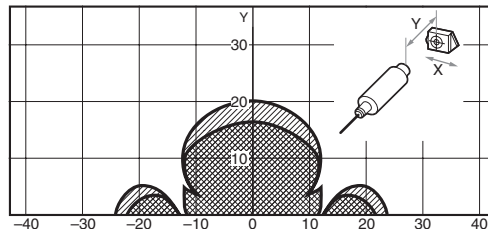

 Read range (in transmission distance priority mode)
  Write range (in transmission distance or transmission time priority mode)
 Read range (in transmission time priority mode)

V600-D23P53 & V600-HS51
+V600-HA51

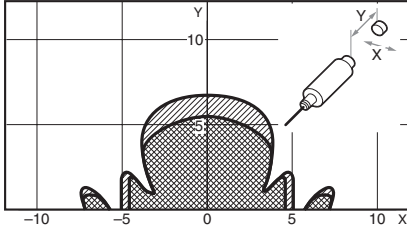

V600-D23P53 & V600-HS61
+V600-HA51

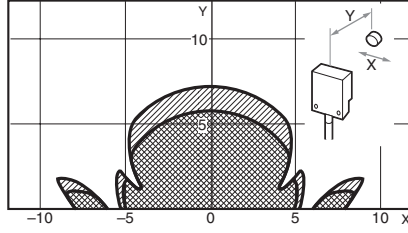

V600-D23P53 & V600-H52

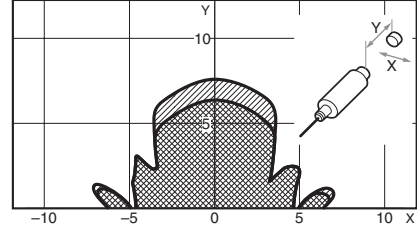

V600-D23P54 & V600-HS51
+V600-HA51

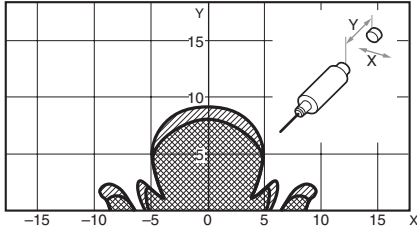

V600-D23P54 & V600-HS61
+V600-HA51

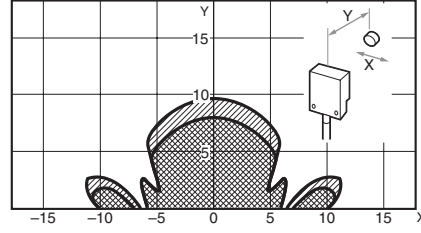

V600-D23P54 & V600-H52

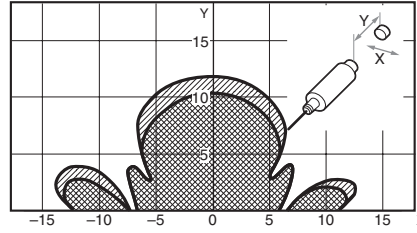

V600-D23P55 & V600-HS51
+V600-HA51

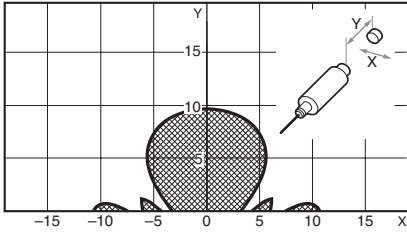

V600-D23P55 & V600-HS61
+V600-HA51

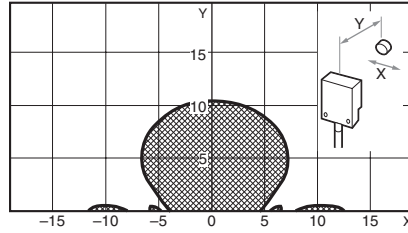

V600-D23P55 & V600-H52

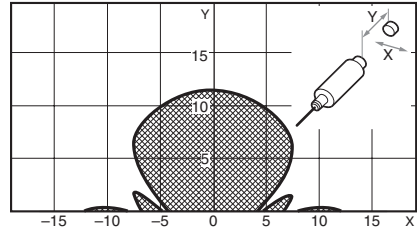

 Read range (in transmission distance priority mode)
  Write range (in transmission distance or transmission time priority mode)

Built-in-Battery DCs

V600-D8KR12 & V600-H07

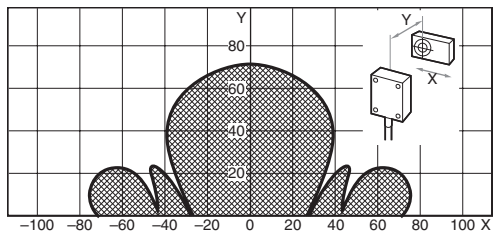

V600-D8KR12 & V600-H11

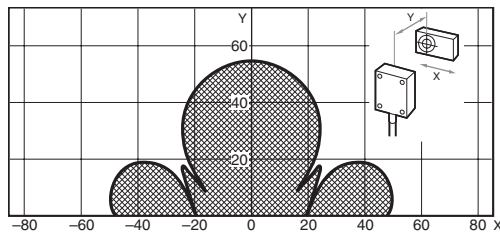

V600-D8KR13 & V600-H07

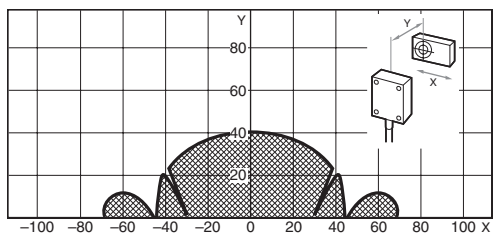

V600-D8KR13 & V600-H11

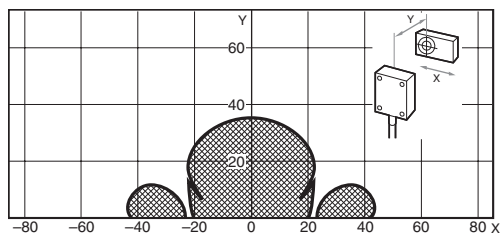

V600-D8KR04 & V600-H07

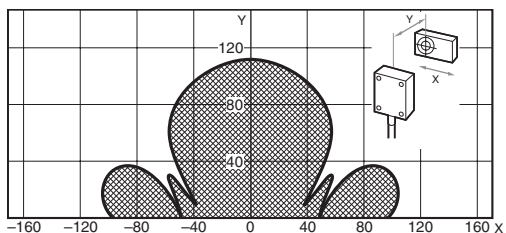

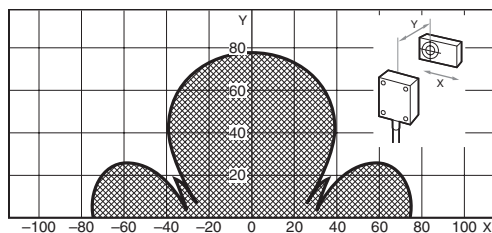

V600-D8KR04 & V600-H11

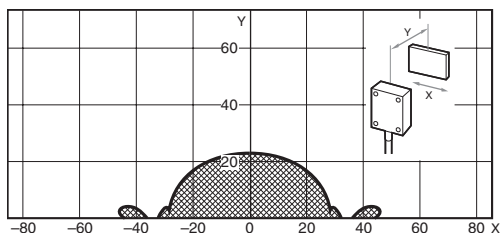

Replaceable-Battery DCs

V600-D2KR15 & V600-H11



 Read/Write range (in transmission distance or transmission time priority mode)

Transmission Time

- The transmission time does not depend on the model of R/W Head or Data Carrier, although transmission times differ between Data Carriers with and without batteries.
- The turn around time (TAT) is the total time required from the issuance of a command from the host device (for example, a host computer) until the reception of a response.

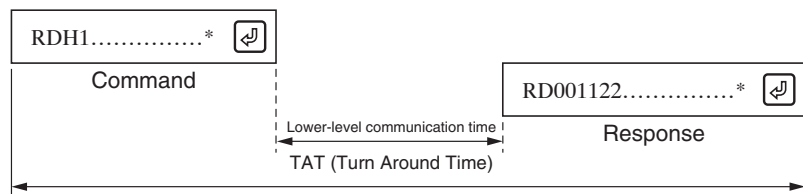

- The lower-level communications time does not include the host communications; it is the time required for communications between the R/W Head and Data Carrier. The lower-level communications time is used in the equation for the DC speed.

$$\text{DC Speed} = (\text{Distance travelled in the transmission range}) / (\text{Lower-level communications time})$$

Transmission Time with Built-in-Battery Data Carriers (Reference)

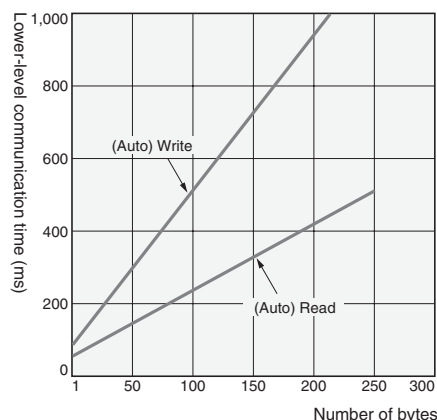

Calculation (Reference)

	Lower-level communications time (ms)
READ	$t = 1.8 N + 48.4$
WRITE	$t = 4.2 N + 86.5$

N is the number of processing bytes.

Transmission Time with Battery-less Data Carriers (Reference)

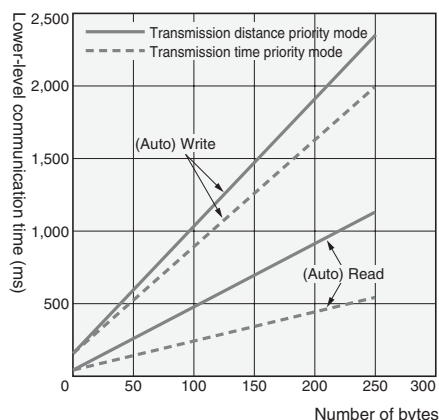

Calculation (Reference)

	R/W	Lower-level communications time (ms)
Distance priority mode	READ	$t = 4.3 N + 64.6$
	WRITE	$t = 8.7 N + 167.1$
Time priority mode	READ	$t = 1.8 N + 79.0$
	WRITE	$t = 7.1 N + 180.4$

N is the number of processing bytes.

Lower-Level Communications Mode Setting (Distance/Time Priority)

The lower-level communications mode setting is made with a DIP Switch or memory switch on the Serial-interface Controller (V600-CA1A-□/-CA2A-□, V600-CD1D-V3, V600-CMID) or ID Sensor Unit. (Refer to the Controller's Operation Manual for more details on this setting.)

With Parallel-interface Controllers (V600-CA8A-V2/CA9A-V2) the mode is fixed to transmission distance priority.

Battery Life

The Data Carrier has a built-in lithium battery.

The following graphs show the relationship between the number of bytes per transmission, the number of transmissions per day, and the battery life.

V600-D8KR12 (Typical Example)

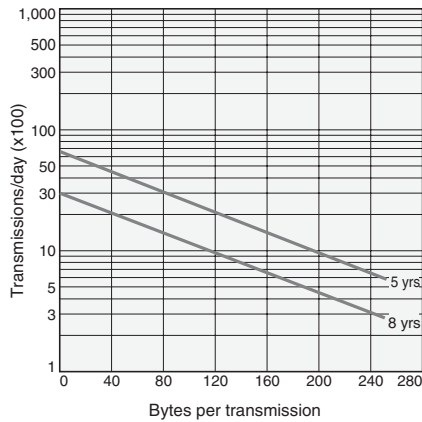

V600-D8KR13 (Typical Example)

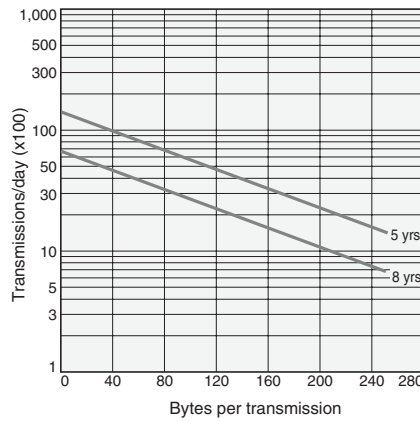

V600-D8KR04 (Typical Example)

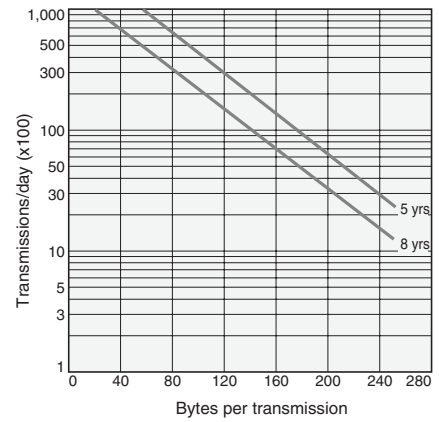

Temperature and Battery Life

V600-D2KR16

The battery life is two years at 25°C regardless of the relationship between the number of bytes read/written and the number of transmissions.

Examples Showing Relationship Between Battery Life and Temperature

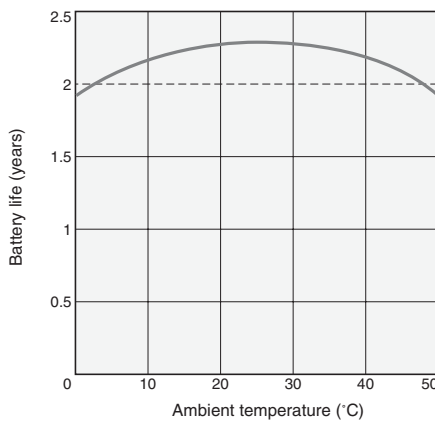

The following table shows the standard values.

Temperature	Battery consumption rate in one year
20°C	1%
30°C	2%
40°C	4%
50°C	8%
60°C	16%
70°C	32%

Note: If the battery is stored at 70°C and is not installed, the battery life is calculated as follows:

$$2 \text{ (years)} \times (1 - 0.32) = 1.36 \text{ years}$$

If the battery is stored at 25°C after one year's storage, the battery life will be approximately 1 year and 4 months. (The battery life will be shortened if the battery is used at temperatures close to 0°C or 50°C.)

The values in the above graph are based on the battery being installed (i.e., the insulation sheet is removed). If the battery is not installed, the values shown in the above table will apply.

Precautions

Correct Use

Data Carrier Batteries

Built-in-Battery Data Carriers

Caution

Do not disassemble, deform by applying pressure, heat at temperatures exceeding 100°C, or burn. Doing so may cause the built-in lithium batteries to combust or explode.

Replaceable-Battery Data Carriers

Caution

Never short-circuit the positive and negative terminals of the batteries, charge the batteries, disassemble them, deform them, or throw them into a fire. Doing so may cause the batteries to explode, combust, or leak liquid.

Mutual Interference

Mutual Interference Between R/W Heads

When using more than one set of R/W Heads, mutual interference between the Heads can be avoided by mounting the Heads at the specified distance as shown below.

V600-H07

- Facing
RD/WT command: 650 mm min.
Auto command: 900 mm min.

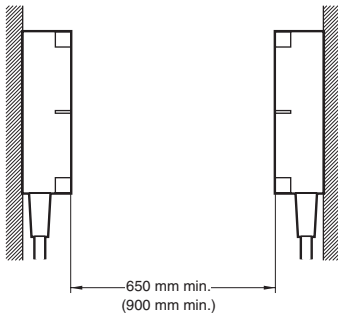

- Side-by-side
RD/WT command: 550 mm min.
Auto command: 1,200 mm min.

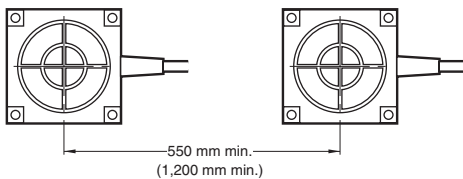

V600-H11

- Facing
RD/WT command: 200 mm min.
Auto command: 200 mm min.

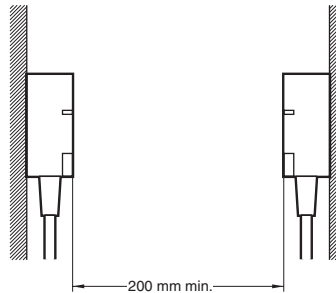

- Side-by-side
RD/WT command: 200 mm min.
Auto command: 200 mm min.

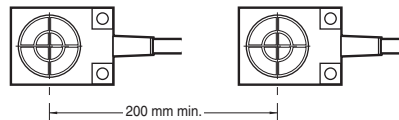

V600-H51

- Facing: 120 mm min.

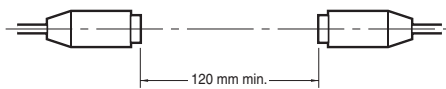

- Side-by-side: 100 mm min.

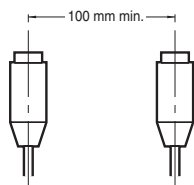

V600-H52

- Facing: 80 mm min.

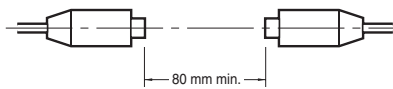

- Side-by-side: 80 mm min.

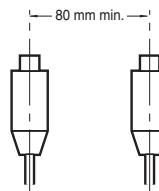

V600-HS51

- Facing: 80 mm min.

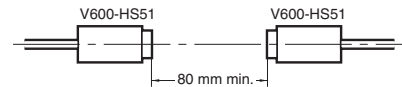

- Side-by-side: 80 mm min.

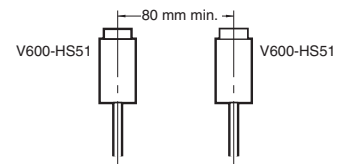

V600-HS61

- Facing: 80 mm min.

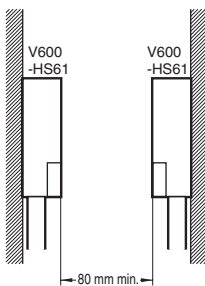

- Side-by-side: 80 mm min.

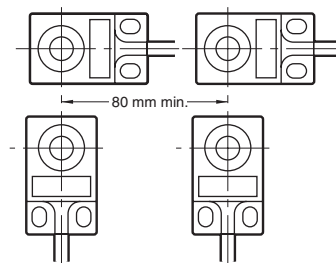

Note: If the two R/W Heads are not transmitting simultaneously (i.e., independent read/write), mutual interference will not occur. Therefore, the restriction on the distance between the Heads will not be applicable. The commands will be received by the R/W Heads and transmission will oscillate between them.

Mutual Interference Between Proximity Sensors

The V600-series Units use electromagnetic coupling (frequency: 530 kHz). When a V600 Unit is wired close to R/W Heads, Proximity Switches, and Sensors that have an oscillating frequency between 400 and 600 kHz, the Proximity Sensor may malfunction, so be sure to install the Units according to the distance restrictions specified in the following diagrams. Make sure to thoroughly test that the mounting positions and the fixed positions of the Sensors are correct before putting them into actual operation.

V600-H07

- Vertical: 400 mm min.

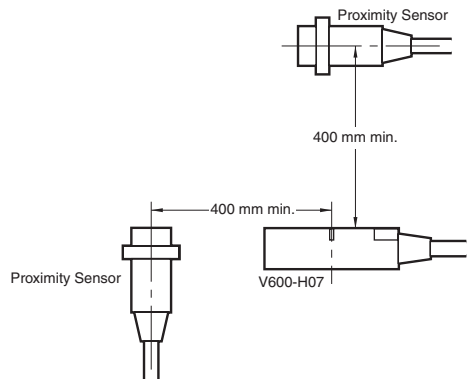

- Facing: 300 mm min.

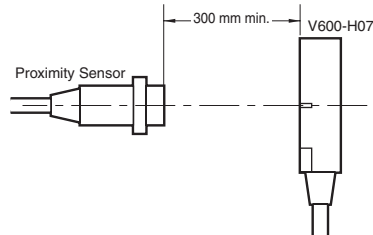

V600-H11

- Vertical: 100 mm min.

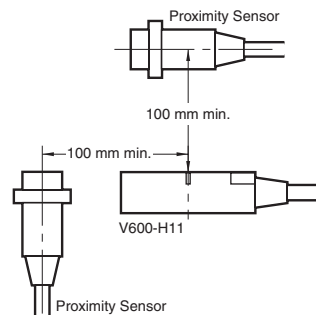

- Facing: 100 mm min.

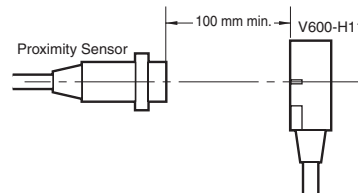

V600-H51/H52

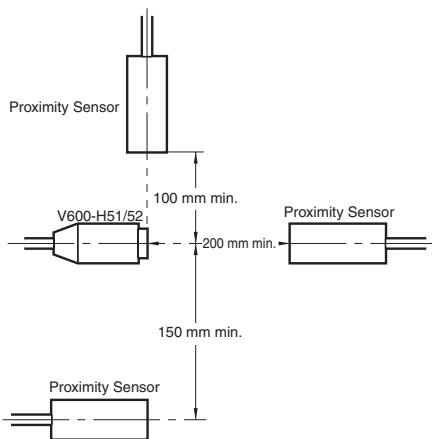

V600-HS51

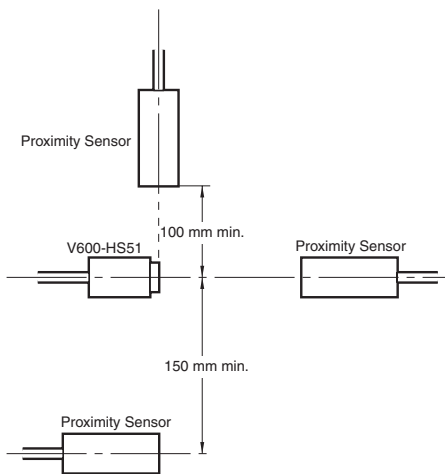

V600-HS61

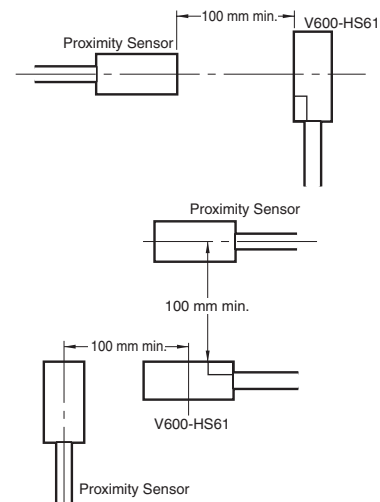

Mutual Interference Between Data Carriers

When more than one Data Carrier is used, mutual interference between the DCs can be avoided by making sure that they are mounted apart at the distances specified below.

(Reading/writing)

V600-D23P53

R/W Head: V600-H52, V500-HS51 + V600-HA51, V600-HS61 + V600-HA51

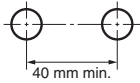

V600-D23P55

R/W Head: V600-H52, V600-HS51 + V600-HA51, V600-HS61 + V600-HA51

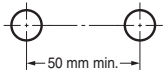

V600-D23P66N

R/W Head: V600-H11

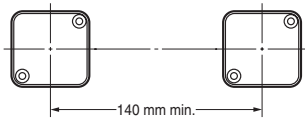

R/W Head: V600-H07

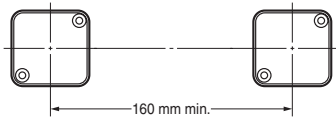

V600-D23P72

R/W Head: V600-H51

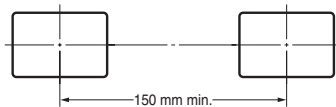

R/W Head: V600-H11

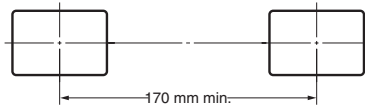

R/W Head: V600-H07

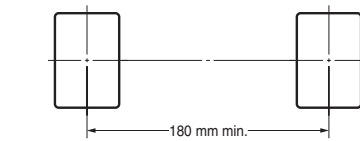
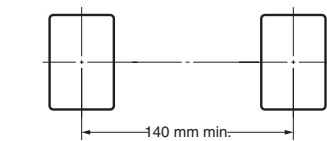
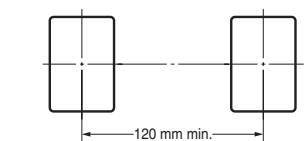
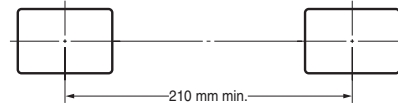

V600-D23P66SP

R/W Head: V600-H07

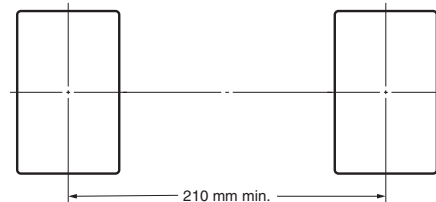
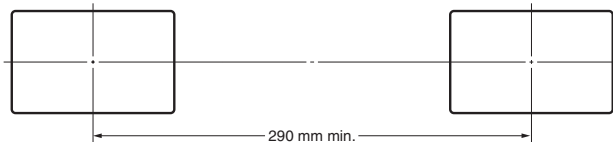

V600-D23P54

R/W Head: V600-H52, V600-HS51 + V600-HA51, V600-HS61 + V600-HA51

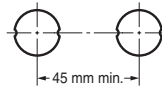

V600-D23P61

R/W Head: V600-H11/-H51

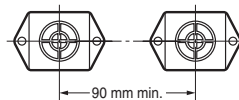

V600-D23P66SP

R/W Head: V600-H11

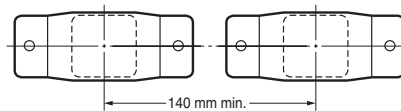

R/W Head: 600-H07

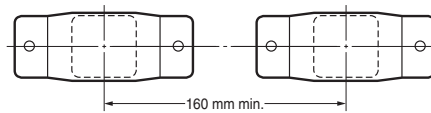

V600-D8KR12

R/W Head: V600-H11

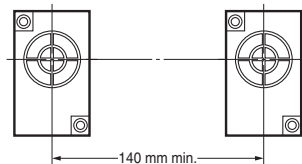
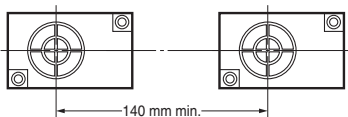

R/W Head: V600-H07

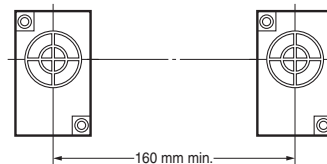
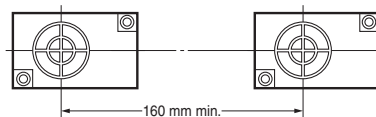

V600-D8KR13

R/W Head: V600-H11

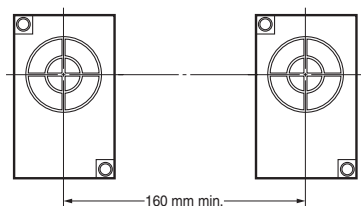
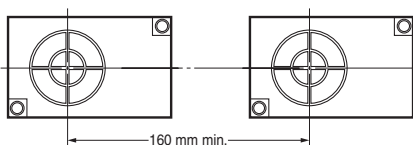

R/W Head: V600-H07

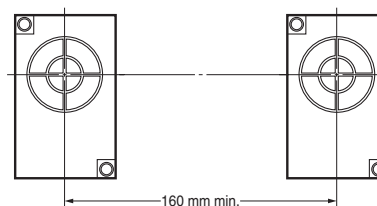
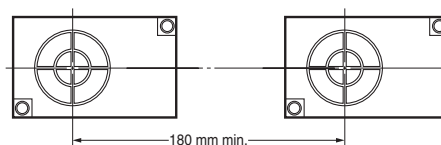

V600-D8KR04

R/W Head: V600-H11

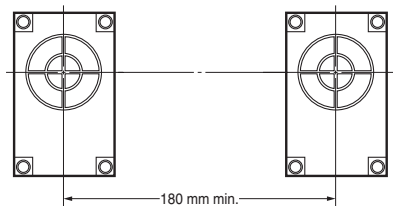
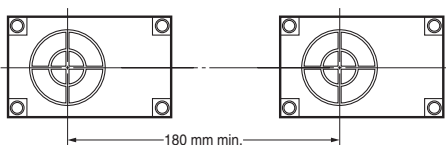

R/W Head: V600-H07

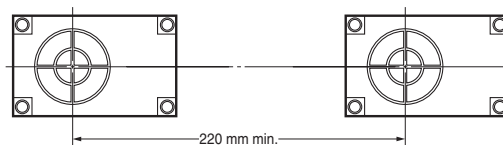

V600-D2KR16

R/W Head: V600-H11

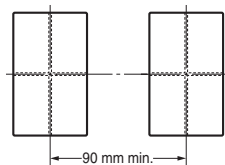
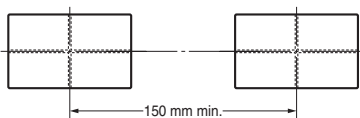

Dimensions

Note: All units are in millimeters unless otherwise indicated.

Data Carriers

Built-in-Battery DCs

V600-D8KR12

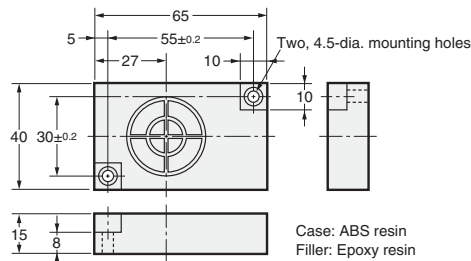

V600-D8KR13

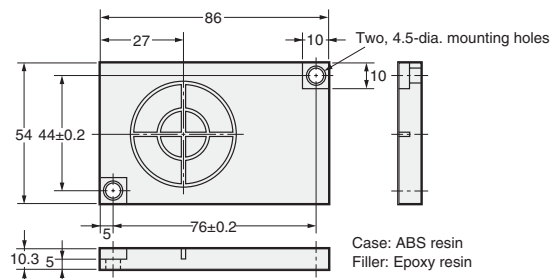

V600-D8KR04

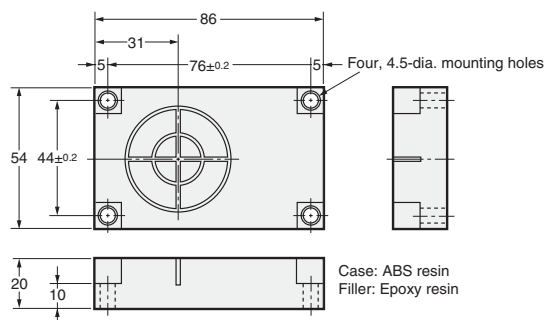

Replaceable-Battery DCs

V600-D2KR16

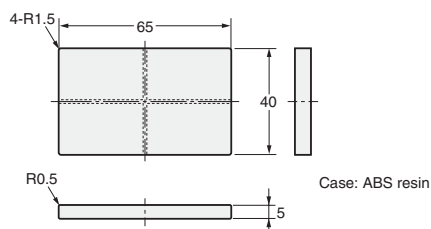

Battery-less DCs

V600-D23P53

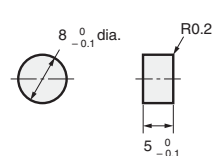

Case: ABS resin
Filler: Epoxy resin

V600-D23P54

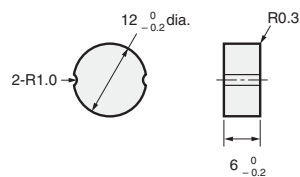

Case: ABS resin
Filler: Epoxy resin

V600-D23P55

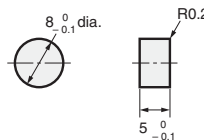

Case: PPS resin
Filler: Epoxy resin

V600-D23P61

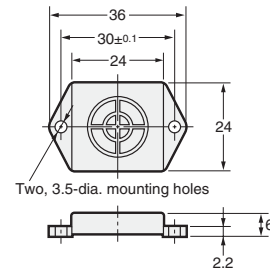

Case: ABS resin
Filler: Epoxy resin

V600-D23P66N

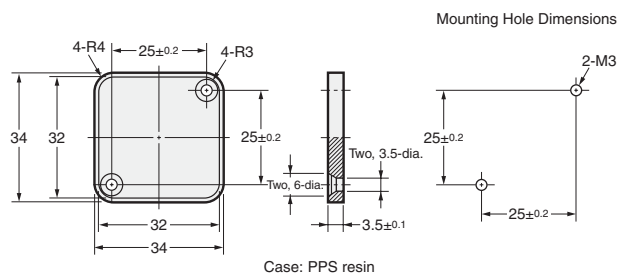

V600-D23P66SP

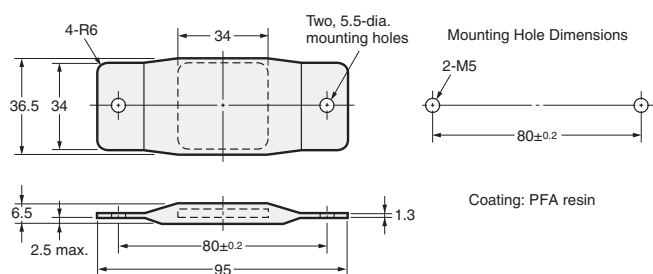

V600-D23P71

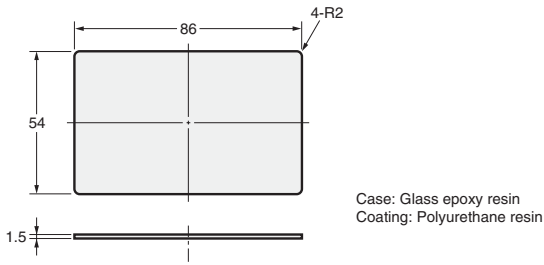

V600-D23P72

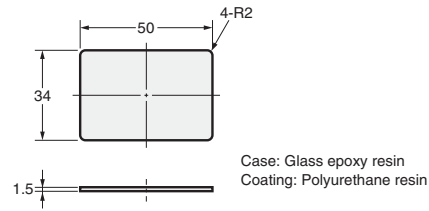

R/W Heads

V600-H07

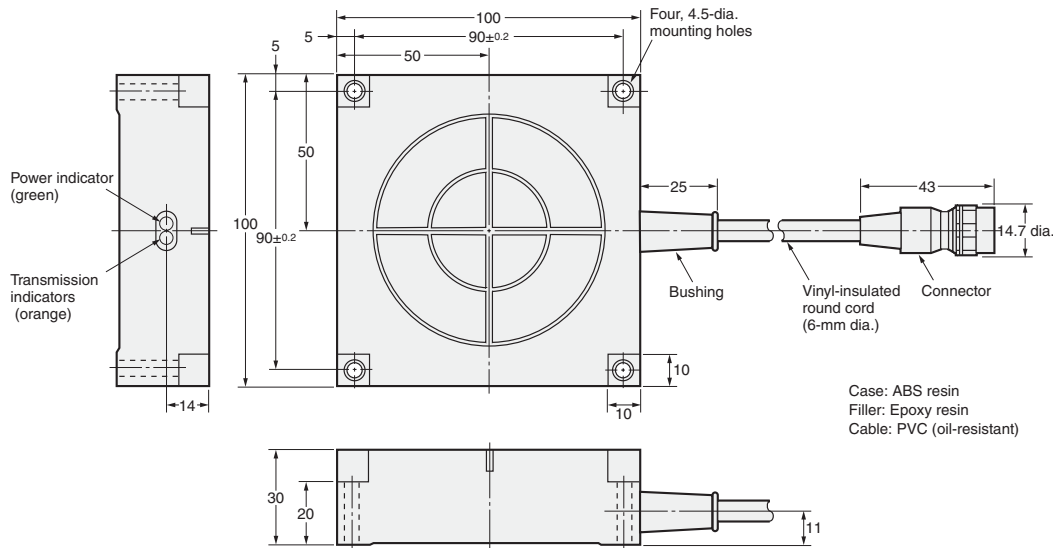

V600-H11

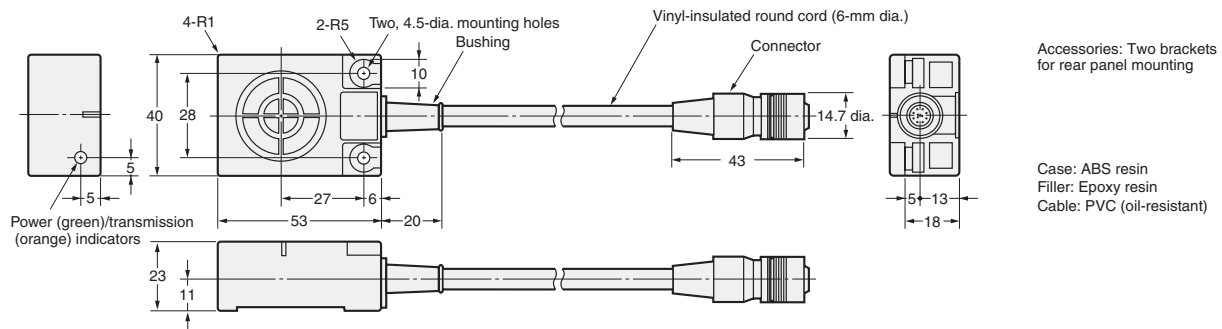

V600-H51

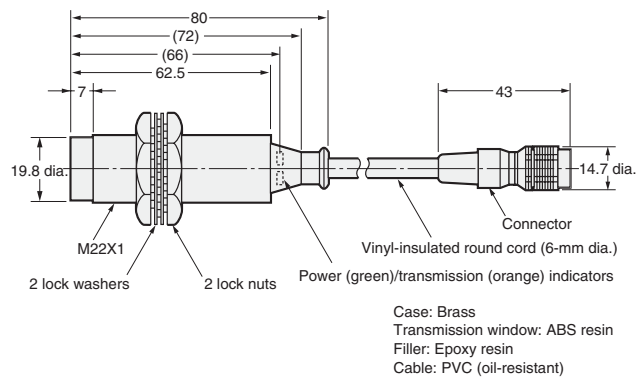

V600-HS51 (Sensor Section)

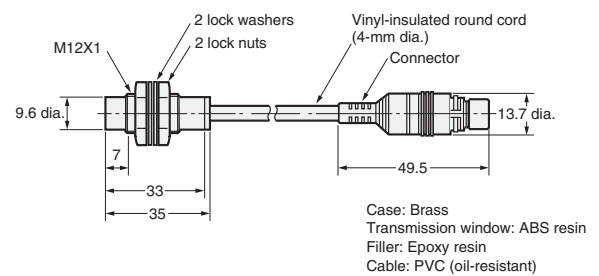

V600-H52

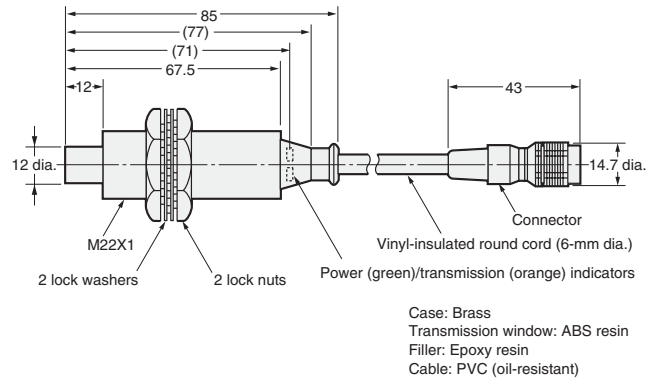

V600-HS61 (Sensor Section)

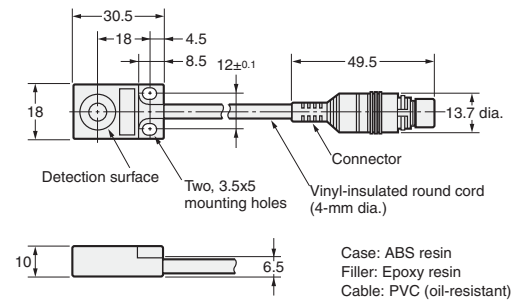

V600-HA51 (Amplifier Section)

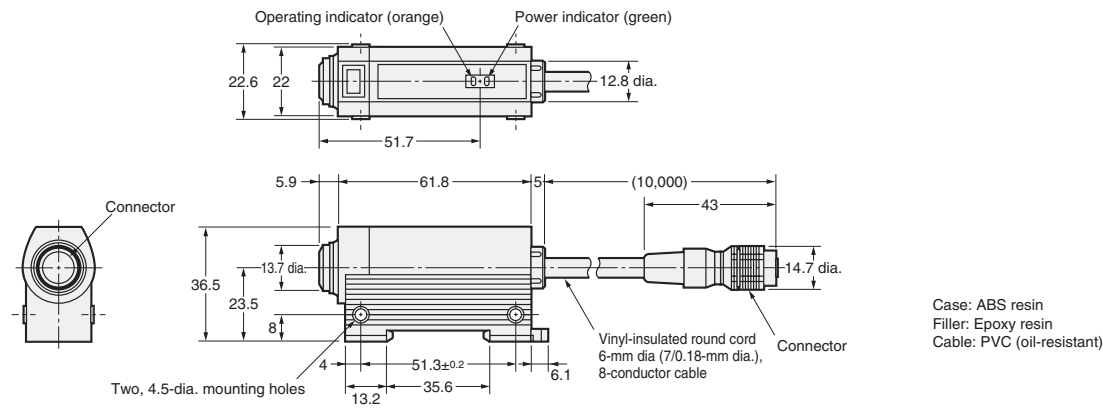

ID Controllers

V600-CA□A-□ (Multi-purpose)

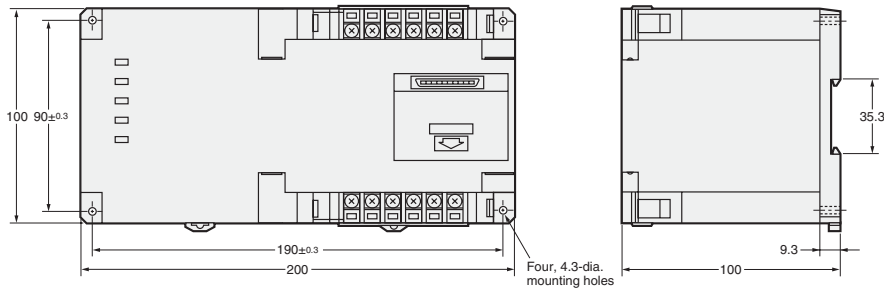

V600-P01 Monitor Unit (For use with V600-CA□A-□)

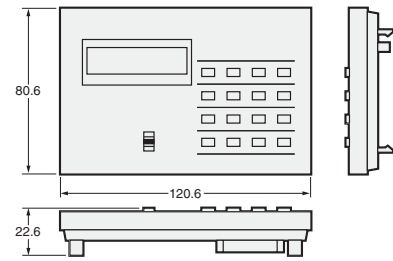

V600-CD1D-V3 (Compact)

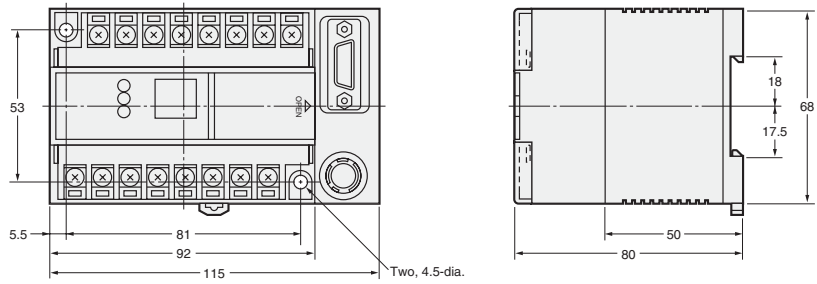

V600-CB-US Handheld ID Controller

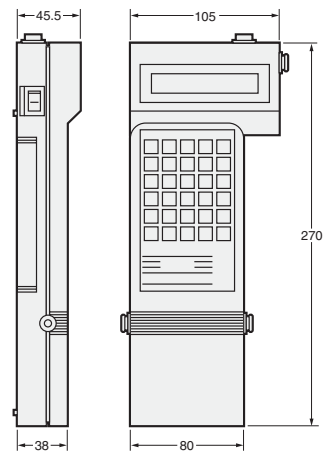

V600-CM1D (Board-Mounted)

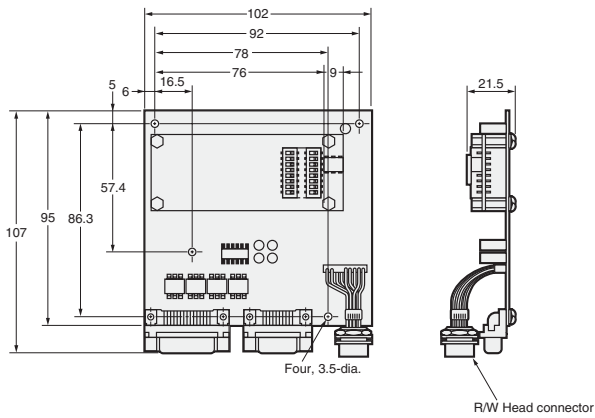

IDSC-C1D□-A (Stand-alone)

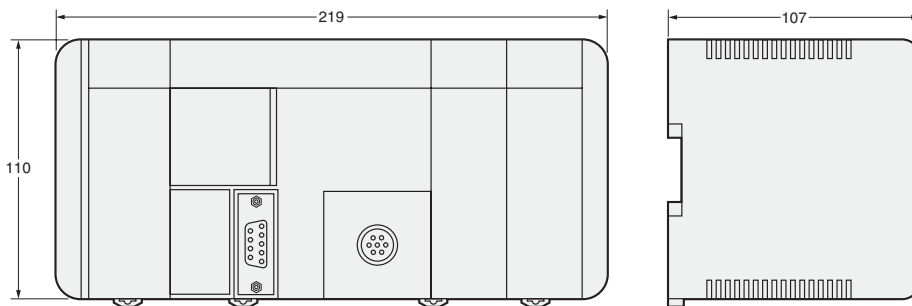

Accessories

V600-CH1D Handheld Reader/Writer

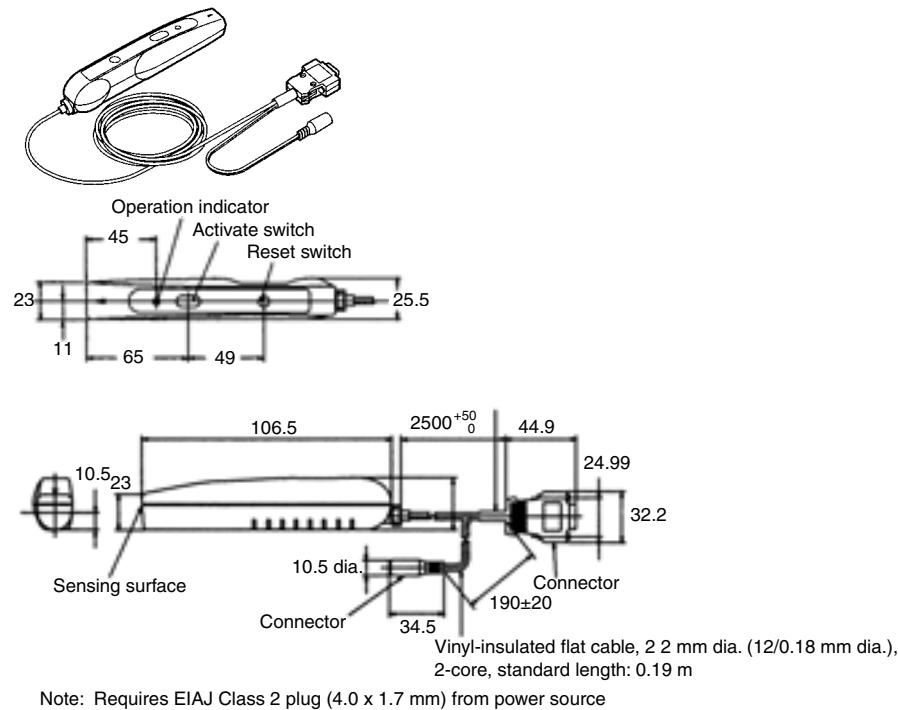

Holder

V600-A81 for V600-D2KR16 Data Carriers

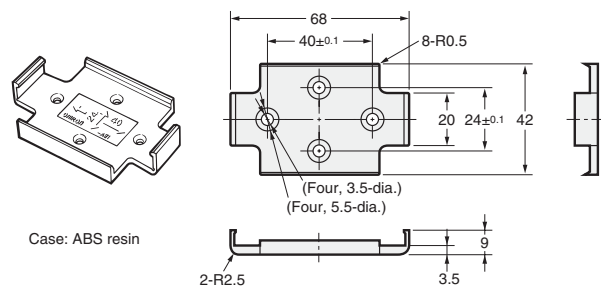

V600-A84 for V600-D23P71/-D23P72 Data Carriers

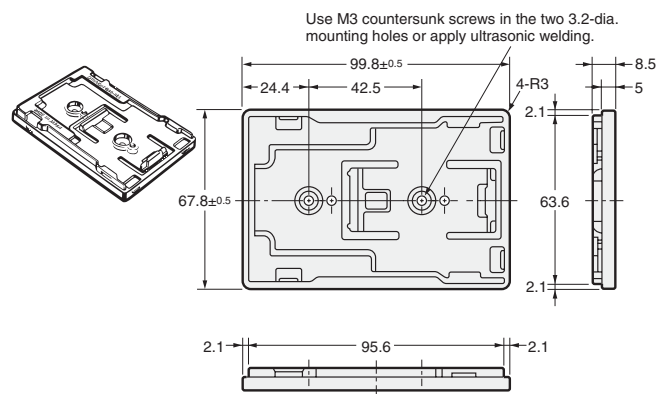

Attachment

V600-A86 for V600-D23P66N Data Carriers

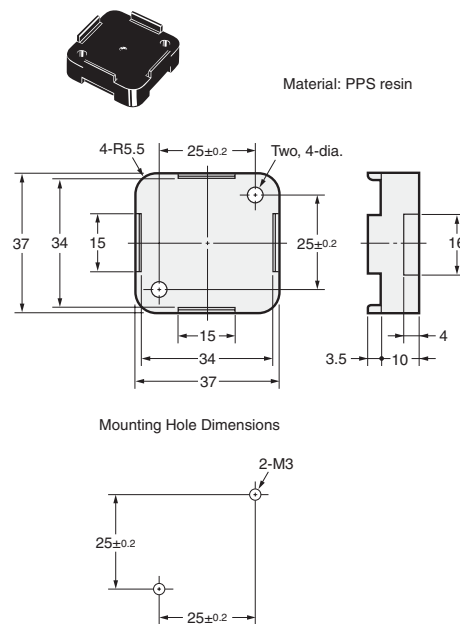

ALL DIMENSIONS SHOWN ARE IN MILLIMETERS.

To convert millimeters into inches, multiply by 0.03937. To convert grams into ounces, multiply by 0.03527.

Terms and Conditions

WARRANTY, LIMITATIONS OF LIABILITY

WARRANTY OMRON's exclusive warranty is that the products are free from defects in materials and workmanship for a period of one year (or other period if specified) from date of sale by OMRON.

OMRON MAKES NO WARRANTY OR REPRESENTATION, EXPRESS OR IMPLIED, REGARDING NON-INFRINGEMENT, MERCHANTABILITY OR FITNESS FOR PARTICULAR PURPOSE OF THE PRODUCTS. ANY BUYER OR USER ACKNOWLEDGES THAT IT ALONE HAS DETERMINED THAT THE PRODUCTS WILL SUITABLY MEET THE REQUIREMENTS OF THEIR INTENDED USE. OMRON DISCLAIMS ALL OTHER WARRANTIES, EXPRESS OR IMPLIED.

LIMITATIONS OF LIABILITY OMRON SHALL NOT BE RESPONSIBLE FOR SPECIAL, INDIRECT OR CONSEQUENTIAL DAMAGES, LOSS OF PROFITS OR COMMERCIAL LOSS IN ANY WAY CONNECTED WITH THE PRODUCTS, WHETHER SUCH CLAIM IS BASED ON CONTRACT, WARRANTY, NEGLIGENCE OR STRICT LIABILITY.

In no event shall responsibility of OMRON for any act exceed the individual price of the product on which liability is asserted.

IN NO EVENT SHALL OMRON BE RESPONSIBLE FOR WARRANTY, REPAIR OR OTHER CLAIMS REGARDING THE PRODUCTS UNLESS OMRON'S ANALYSIS CONFIRMS THAT THE PRODUCTS WERE PROPERLY HANDLED, STORED, INSTALLED AND MAINTAINED AND NOT SUBJECT TO CONTAMINATION, ABUSE, MISUSE, OR INAPPROPRIATE MODIFICATION OR REPAIR.

APPLICATION CONSIDERATIONS

SUITABILITY FOR USE OMRON shall not be responsible for conformity with any standards, codes or regulations which apply to the combination of the product in the customer's application or use of the product.

At the customer's request, OMRON will provide applicable third party certification documents identifying ratings and limitations of use which apply to the product. This information by itself is not sufficient for a complete determination of the suitability of the product in combination with the end product, machine, system, or other application or use.

The following are some examples of applications for which particular attention must be given. This is not intended to be an exhaustive list

of all possible uses of this product, nor is it intended to imply that the uses listed may be suitable for this product:

- Outdoor use, uses involving potential chemical contamination or electrical interference, or conditions or uses not described in this catalog.
- Nuclear energy control systems, combustion systems, railroad systems, aviation systems, medical equipment, amusement machines, vehicles, safety equipment, and installations subject to separate industry or government regulations.
- Systems, machines and equipment that could present a risk to life or property.

Please know and observe all prohibitions of use applicable to this product.

NEVER USE THE PRODUCT FOR AN APPLICATION INVOLVING SERIOUS RISK TO LIFE OR PROPERTY WITHOUT ENSURING THAT THE SYSTEM AS A WHOLE HAS BEEN DESIGNED TO ADDRESS THE RISKS, AND THAT THE OMRON PRODUCT IS PROPERLY RATED AND INSTALLED FOR THE INTENDED USE WITHIN THE OVERALL EQUIPMENT OR SYSTEM.

PROGRAMMABLE PRODUCTS OMRON shall not be responsible for the user's programming of a programmable product, or any consequence thereof.

DISCLAIMERS

PERFORMANCE DATA Performance data given in this catalog is provided as a guide for the user in determining suitability and does not constitute a warranty. It may represent the result of OMRON's test conditions, and the user must correlate it to actual application requirements. Actual performance is subject to the OMRON Warranty and Limitations of Liability.

CHANGE IN SPECIFICATIONS Product specifications and accessories may be changed at any time based on improvements and other reasons. It is our practice to change part numbers when published ratings or features are changed, or when significant construction changes are made. However, some specifications of the product may be changed without any notice. When in doubt, special part numbers may be assigned to fix or establish key specifications for your application. Please consult with your OMRON representative at any time to confirm actual specifications of purchased product.

ERRORS AND OMISSIONS The information in this catalog has been carefully checked and is believed to be accurate; however, no responsibility is assumed for clerical, typographical or proofreading errors, or omissions.

Complete terms and conditions for product purchase and use are on Omron's website at www.omron.com/oei – under the "About Us" tab, in the Legal Matters section.

ALL DIMENSIONS SHOWN ARE IN MILLIMETERS. To convert millimeters into inches, divide by 25.4

OMRON®

OMRON ELECTRONICS LLC

One Commerce Drive
Schaumburg, IL 60173

847-843-7900

For US technical support or other inquiries:

800-556-6766

OMRON CANADA, INC.

885 Milner Avenue
Toronto, Ontario M1B 5V8

416-286-6465

OMRON ON-LINE

Global - <http://www.omron.com>
USA - <http://www.omron.com/oei>
Canada - <http://www.omron.ca>