



PART NO.

MCRP Series

REVISIONS

ECN #	REV	DESCRIPTION	DRAWN	DATE	CHECKD	DATE	APPRVD	DATE
-	A	RELEASED	Venkat	08/2/08	Suresh	08/2/08	G. C	25/2/08

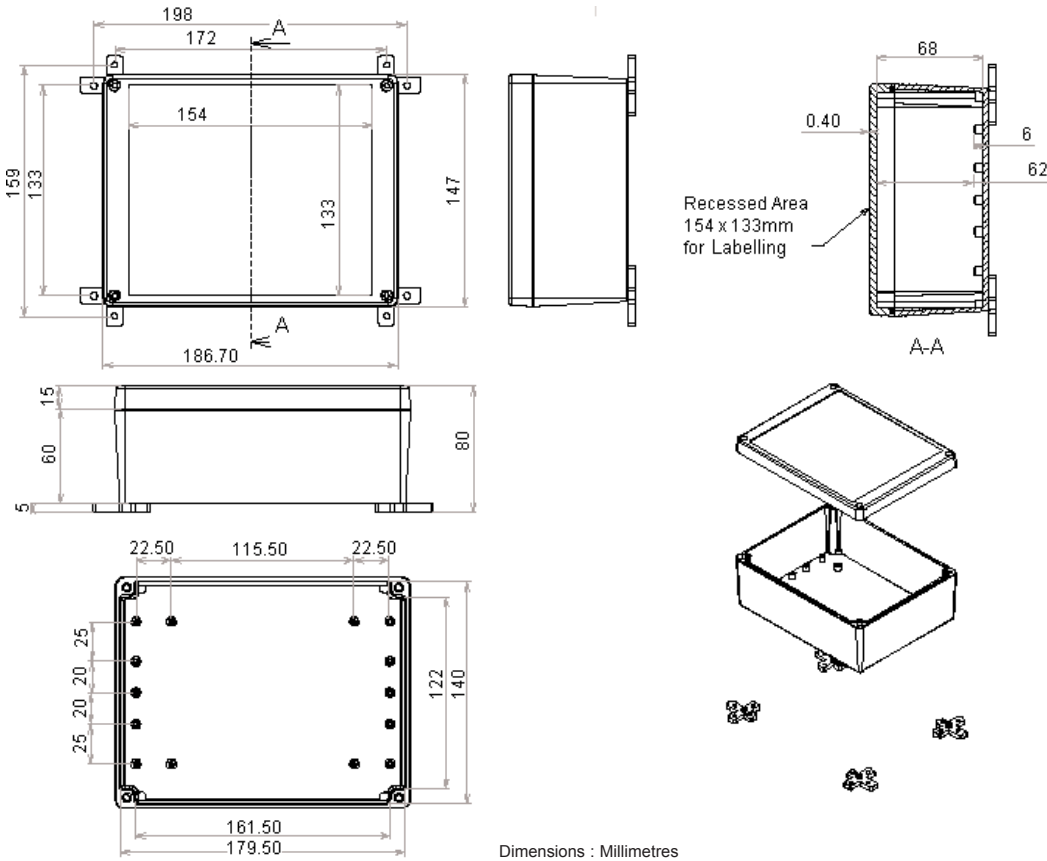

Dimensions : Millimetres

This data sheet and its contents (the "Information") belong to the Premier Farnell Group (the "Group") or are licensed to it. No licence is granted for the use of it other than for information purposes in connection with the products to which it relates. No licence of any intellectual property rights is granted. The Information is subject to change without notice and replaces all data sheets previously supplied. The Information supplied is believed to be accurate but the Group assumes no responsibility for its accuracy or completeness, any error in or omission from it or for any use made of it. Users of this data sheet should check for themselves the Information and the suitability of the products for their purpose and not make any assumptions based on information included or omitted. Liability for loss or damage resulting from any reliance on the Information or use of it (including liability resulting from negligence or where the Group was aware of the possibility of such loss or damage arising) is excluded. This will not operate to limit or restrict the Group's liability for death or personal injury resulting from its negligence. SPC MULTICOMP is the registered trademark of the Group. © Premier Farnell plc 2008.

TOLERANCES:
UNLESS OTHERWISE SPECIFIED, DIMENSIONS ARE FOR REFERENCE PURPOSES ONLY.

DRAWN BY:	DATE:
Venkat	08/02/08
CHECKED BY:	DATE:
Suresh	08/02/08
APPROVED BY:	DATE:
G.Cook	25/02/08

DRAWING TITLE:

Weatherproof Enclosure - Polycarbonate and ABS

SIZE	DWG NO.	ELECTRONIC FILE	REV
A	M10000712	RP1285_DWG	A
SCALE: NTS		U.O.M.: mm	SHEET: 1 OF 1



PART NO.

MCRP Series

REVISIONS

ECN #	REV	DESCRIPTION	DRAWN	DATE	CHECKD	DATE	APPRVD	DATE
-	A	RELEASED	Venkat	08/2/08	Suresh	08/2/08	G. C	25/2/08

Specifications:

- Waterproof : IP65.
- Supply : Stainless fixing screws x 4 pieces
EPDM gasket x 1 piece
PCB mounting screw x 4 pieces.
- Option : Mounting plate : Sheet metal x 1 piece
Mounting feet : MF0045 x 4 pieces.

Specification Table

Material	Size (L x W x D)	Part Number
Polycarbonate	186 x 146 x 75	MCRP1280
ABS		MCRP1285

Dimensions : Millimetres

<http://www.farnell.com>
<http://www.newark.com>
<http://www.cpc.co.uk>

This data sheet and its contents (the "Information") belong to the Premier Farnell Group (the "Group") or are licensed to it. No licence is granted for the use of it other than for information purposes in connection with the products to which it relates. No licence of any intellectual property rights is granted. The Information is subject to change without notice and replaces all data sheets previously supplied. The Information supplied is believed to be accurate but the Group assumes no responsibility for its accuracy or completeness, any error in or omission from it or for any use made of it. Users of this data sheet should check for themselves the Information and the suitability of the products for their purpose and not make any assumptions based on information included or omitted. Liability for loss or damage resulting from any reliance on the Information or use of it (including liability resulting from negligence or where the Group was aware of the possibility of such loss or damage arising) is excluded. This will not operate to limit or restrict the Group's liability for death or personal injury resulting from its negligence. SPC MULTICOMP is the registered trademark of the Group. © Premier Farnell plc 2008.

**TOLERANCES:
UNLESS OTHERWISE SPECIFIED, DIMENSIONS ARE FOR REFERENCE PURPOSES ONLY.**

DRAWN BY:	DATE:
Venkat	08/02/08
CHECKED BY:	DATE:
Suresh	08/02/08
APPROVED BY:	DATE:
G.Cook	25/02/08

DRAWING TITLE:			
Weatherproof Enclosure - Polycarbonate and ABS			
SIZE	DWG NO.	ELECTRONIC FILE	REV
A	M10000712	RP1285_DWG	A
SCALE: NTS		U.O.M.: mm	SHEET: 2 OF 1