



NP12-12 NP12-12FR

Sealed Rechargeable
Lead-Acid Battery

12V, 12.0Ah

Specifications

- **NOMINAL VOLTAGE:** 12V
- **NOMINAL CAPACITY:**

20 hr. rate of	0.6A to 10.5V	12.0Ah
10 hr. rate of	1.1A to 10.5V	11.0Ah
5 hr. rate of	2.1A to 10.2V	10.5Ah
1 hr. rate of	7.2A to 9.60V	7.2Ah
- **WEIGHT (approx.):** 8.82 pounds (4 kgs.)
- **ENERGY DENSITY (20 hr. rate):** 1.70 WH/cubic inch (103.5 WH/liter)
- **SPECIFIC ENERGY (20 hr. rate):** 16.3 WH/pound (36.0 WH/kg)
- **INTERNAL RESISTANCE OF CHARGED BATTERY:** 16 milliohms (approx.)
- **MAXIMUM DISCHARGE CURRENT WITH STANDARD TERMINALS:** 40 amperes
- **MAXIMUM SHORT-DURATION DISCHARGE CURRENT:** 360 amperes
- **OPERATING TEMPERATURE RANGE:**

CHARGE	5°F to 122°F
	(-15°C to 50°C)
DISCHARGE	-4°F to 140°F
	(-20°C to 60°C)
- **CHARGE RETENTION (shelf life) at 68°F (20°C):**

1 month	97%
3 months	91%
6 months	85%
- **LIFE EXPECTANCY:**

STANDBY USE	3 to 5 years
CYCLE USE (approx.):	
100% depth of discharge	250 cycles
50% depth of discharge	550 cycles
30% depth of discharge	1200 cycles
- **SEALED CONSTRUCTION:** Can be operated in any position without leakage.
- **STANDARD TERMINAL:** Quick Disconnect .250
- **HOUSING MATERIAL:** ABS Resin
- **OPTIONAL:** Container and cover made from Flame Retardant ABS (UL94-V0/L.O.I.>28%)

Terminal

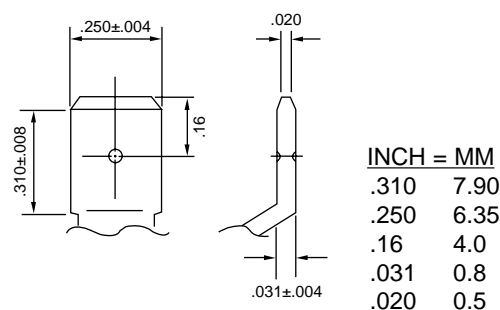

Dimensions

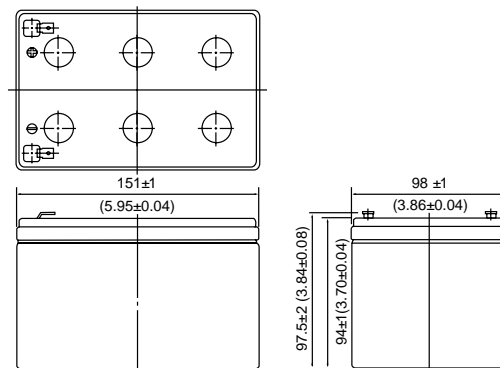

DIMENSIONS: MM (INCHES)

RECOGNIZED BY UL, File No. MH 16464

EnerSys™

Power/Full Solutions™

DISCHARGE CHARACTERISTIC CURVES AT 25°C (77°F)

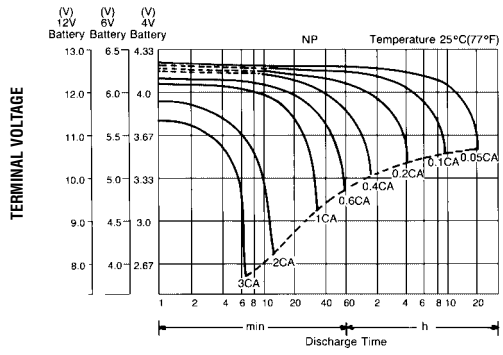

TEMPERATURE EFFECTS IN RELATION TO BATTERY CAPACITY

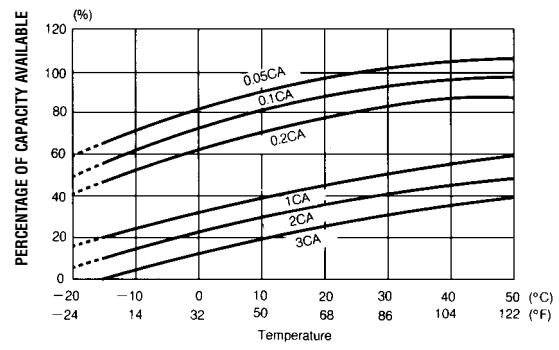

SELF DISCHARGE CHARACTERISTICS

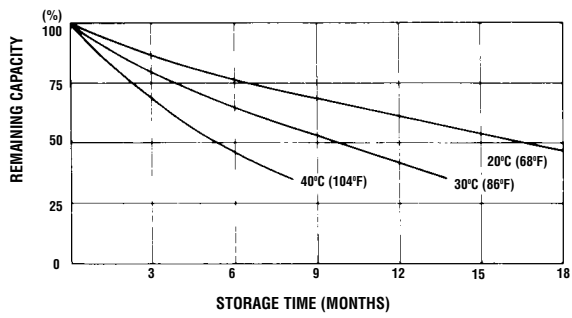

OPEN CIRCUIT VOLTAGE VS REMAINING CAPACITY

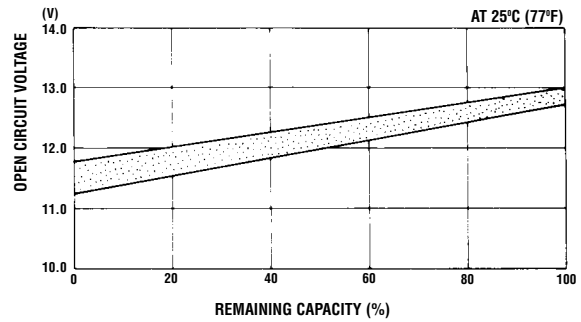

CYCLE SERVICE LIFE IN RELATION TO DEPTH OF DISCHARGE

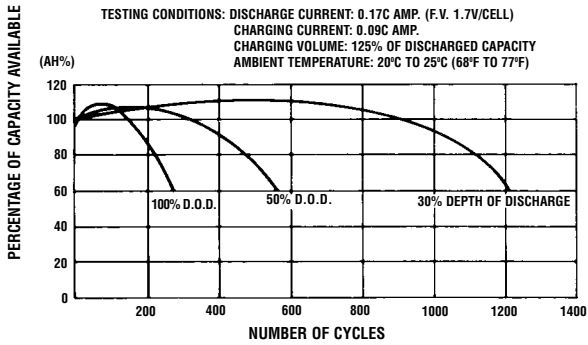

FLOAT SERVICE LIFE

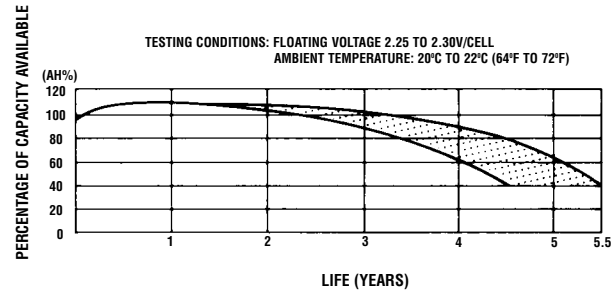

When the battery will be used by current in excess of 3C, consult with EnerSys, Inc. prior to use.

CHARGING METHODS (At 20°C)

- Cycle use:** Maximum charging current 3.0A
Charging voltage 14.4 to 15.0V
- Standby use:** Float charging voltage 13.50 to 13.80V

- CAUTION**
- Avoid short circuit
 - Do not charge in a sealed container.



EnerSys Inc.
 P.O. Box 14145
 Reading, PA 19612-4145
 USA
 Tel: +1-610-208-1991
 +1-800-538-3627

EnerSys EMEA
 Brussels, Belgium
 Tel: +32 (0)2 247 94 47
EnerSys Asia
 Guangdong, China
 Tel: +86 755 2689 3639

Represented by: