



Eveready Battery Company, Inc.

533 Maryville University Drive  
 St. Louis, MO 63141  
 Telephone 1-800-383-7323  
 Internet: www.energizer.com

## Engineering Data

**D**  
**Alkaline 1.5V**  
 No Added Mercury or Cadmium

### ENERGIZER NO. E95

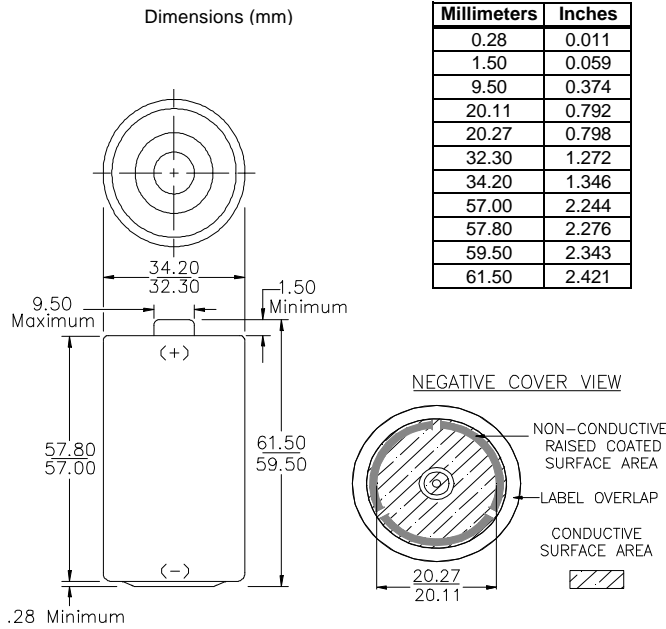

**Chemical System:** Zinc-Manganese Dioxide (Zn/MnO<sub>2</sub>)

**Designation:** ANSI-13A, IEC-LR20

**Battery Voltage:** 1.5 Volts

**Average Weight:** 141.9 grams (5.0 oz.)

**Volume:** 55.9 cubic centimeters (3.4 cubic inch)

**Average Service capacity (to 0.8 Volts / cell):** 18000 mAh  
 (Rated Capacity at 25 mA continuous drain)

**Cell:** One No. 3-350 (size "D")

**Jacket:** Plastic Label

**Shelf Life:** 7 years

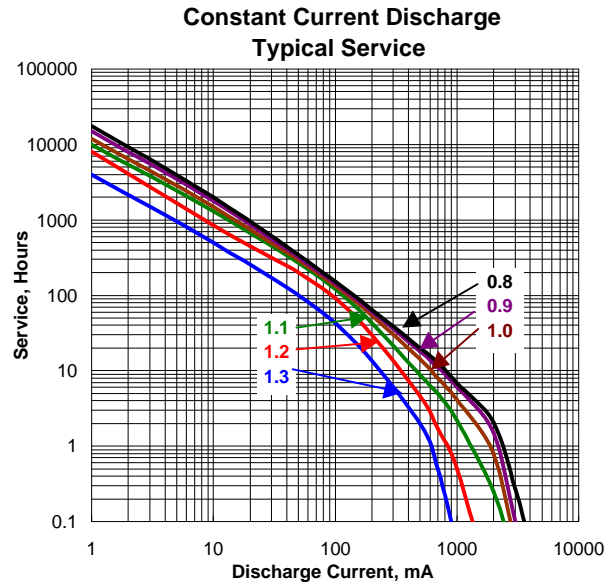
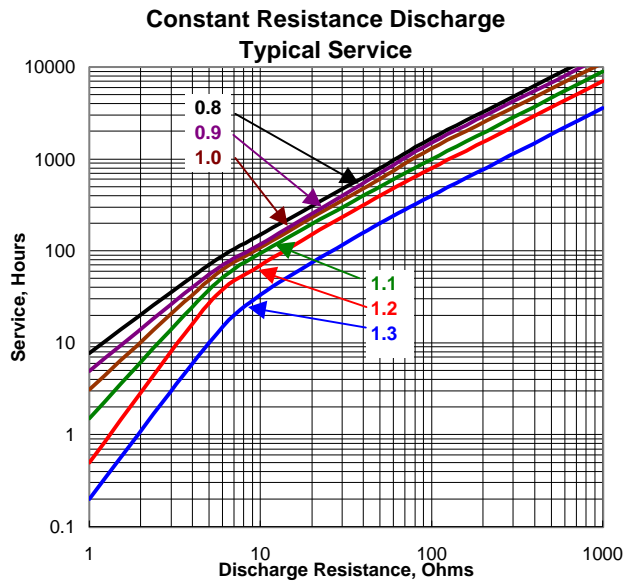
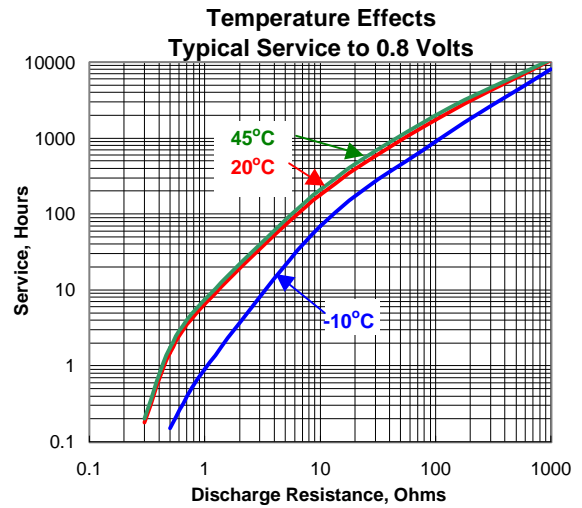

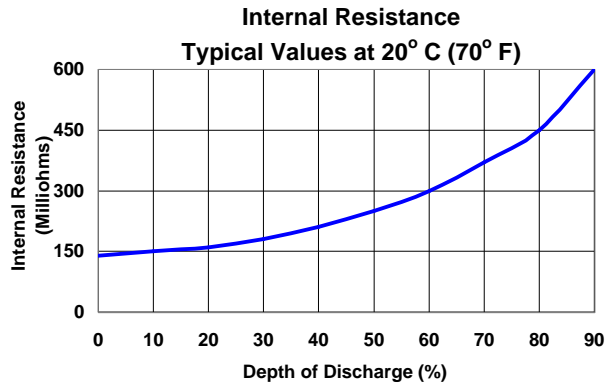

## Typical Applications

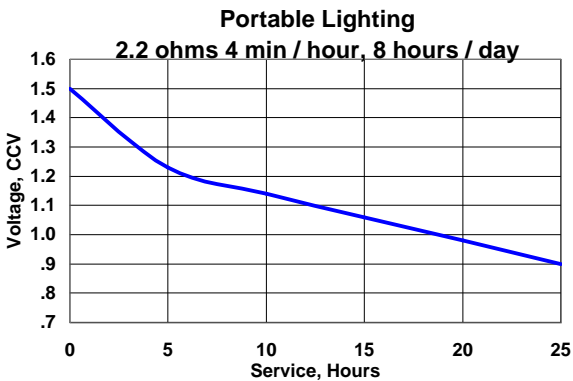
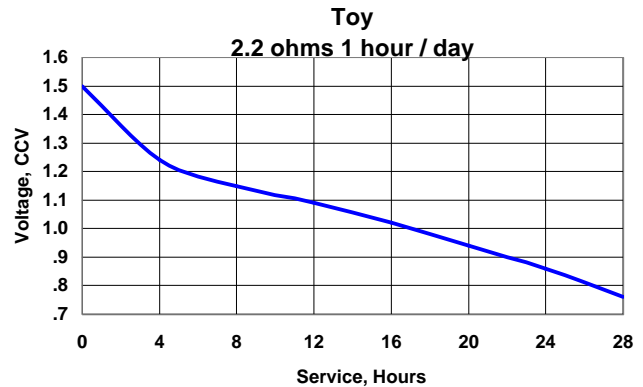
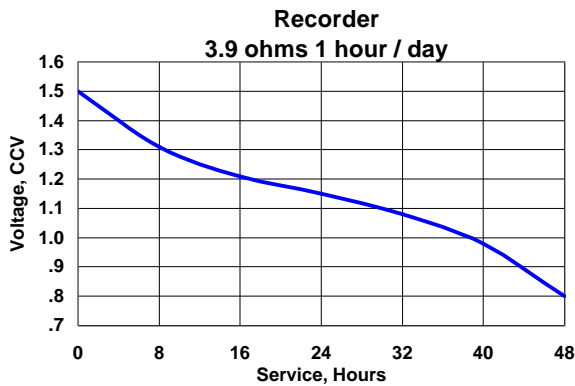
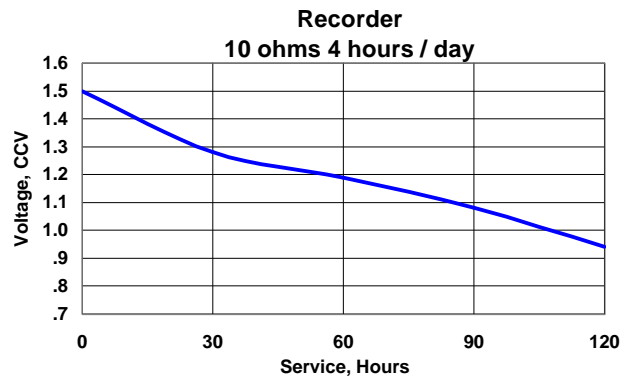
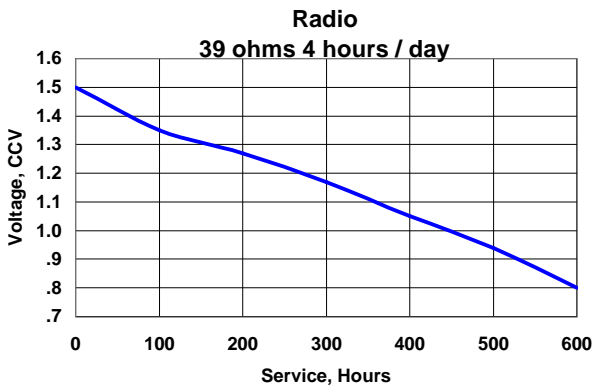

### Important Notice

This data sheet contains information specific to batteries manufactured at time of its publication. Please contact your Energizer representative for most current information. Contents herein do not constitute a warranty.