

EVEREADY BATTERY CO. 1-800-383-7323 / USA  
 Internet: www.energizer.com 1-800-383-7323 / CANADA  
 + 44 (0) 208 920 2306 / EUROPE

## ENERGIZER NO. X95

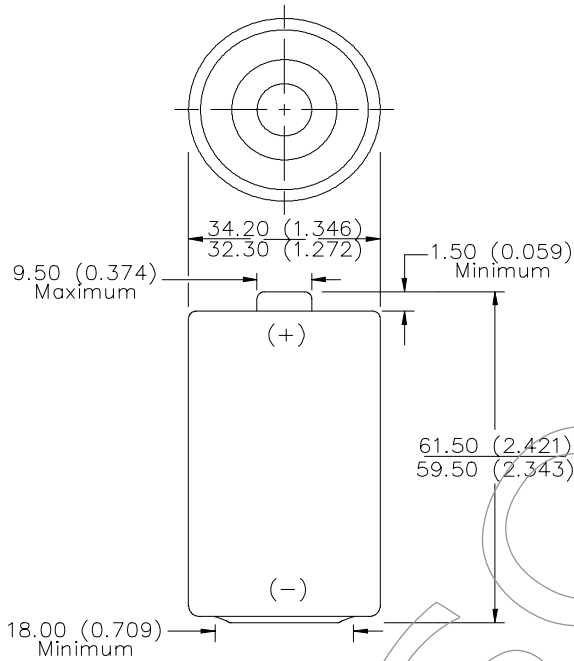

Industry Standard Dimensions in mm (inches)



**D**

**Chemical System:** Alkaline  
 Zinc-Manganese Dioxide (Zn/MnO<sub>2</sub>)  
 (No Added Mercury or Cadmium)

**Designation:** ANSI-13A, IEC-LR20

**Battery Voltage:** 1.5 Volts

**Internal Resistance:** 173 Milliohms (Fresh)

**Operating Temp:** -18°C to 55°C (0°F to 130°F)

**Average Capacity:** 21,500 mAh (to 0.8 volts)  
 (Rated capacity at 25 mA continuous drain)

**Average Weight:** 148.0 grams (5.2 oz.)

**Volume:** 55.9 cubic centimeters (3.4 cubic inch)

**Cell:** One No. X3-350 (size 'D')

**Jacket:** Plastic Label

**Shelf Life:** 7 years (80% of rated capacity)

### TEMPERATURE EFFECTS Typical Service to 0.8 Volts

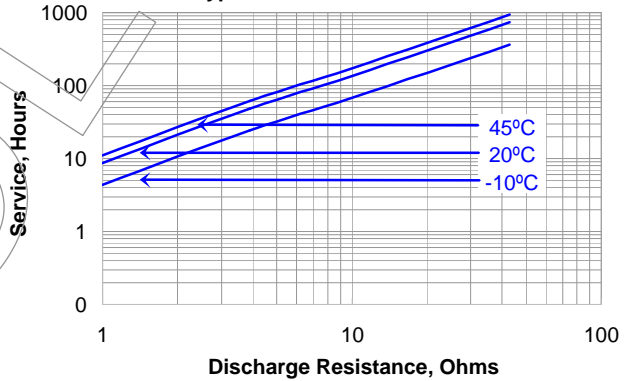

### CONSTANT RESISTANCE PERFORMANCE Typical Service

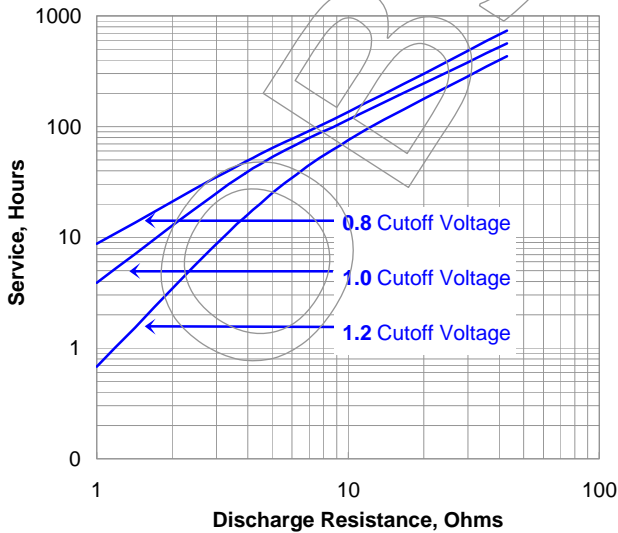

### CONSTANT CURRENT DISCHARGE Typical Service

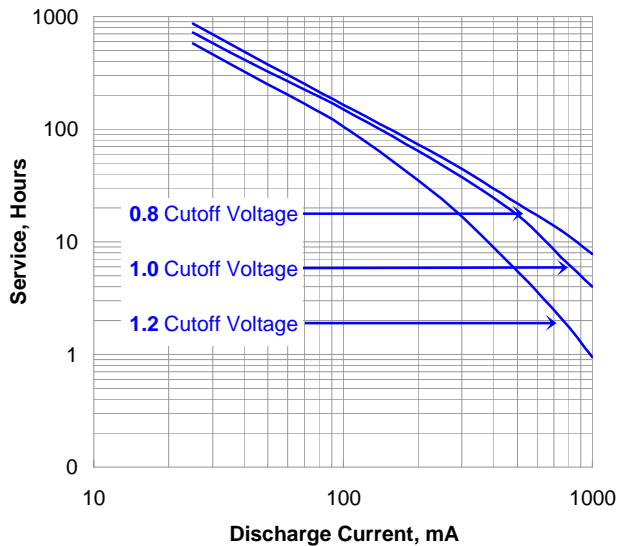

### Important Notice

This data sheet contains information specific to batteries manufactured at the time of its publication.

**Contents herein do not constitute a warranty.**

Copyright © Eveready Battery Co. - All rights reserved

## ENERGIZER NO. X95

### Industry Standard Tests @ 20° C

**PORTABLE LIGHTING**  
1.5 ohm - HIF

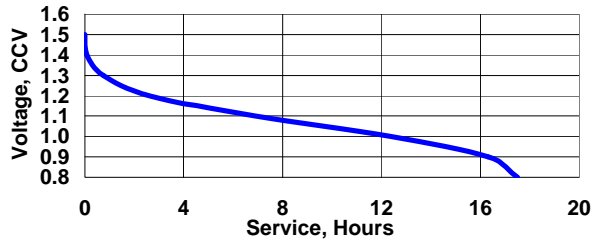

**TOY**  
2.2 ohm - 1hr/day

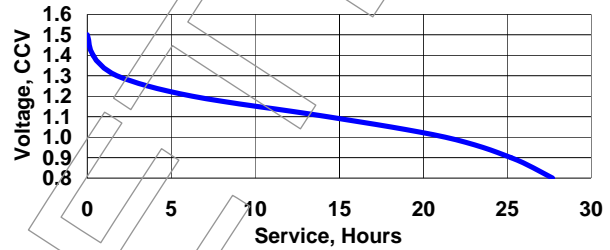

**PORTABLE STEREO**  
600 mA - 2 hr/day

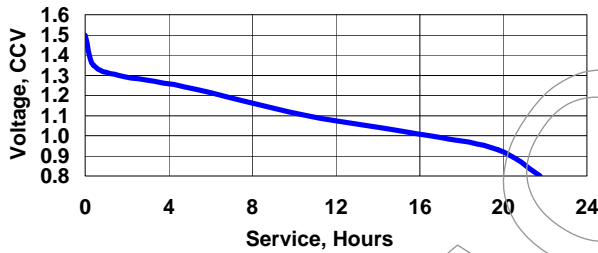

**PORTABLE LIGHTING**  
2.2 ohm - LIF



**RADIO**  
10 ohm - 4 hr/day

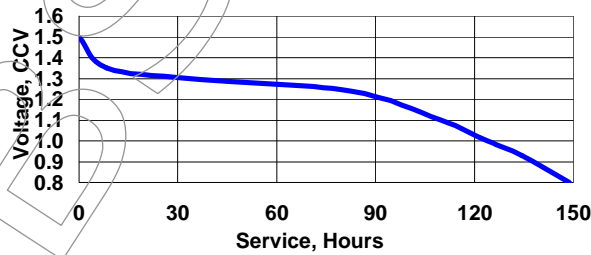

### Important Notice

This data sheet contains information specific to batteries manufactured at the time of its publication.

**Contents herein do not constitute a warranty.**

Copyright © Eveready Battery Co. - All rights reserved