

EVEREADY BATTERY CO. 1-800-383-7323 / USA
 Internet: www.energizer.com 1-800-383-7323 / CANADA
 + 44 (0) 208 920 2306 / EUROPE

ENERGIZER NO. X93

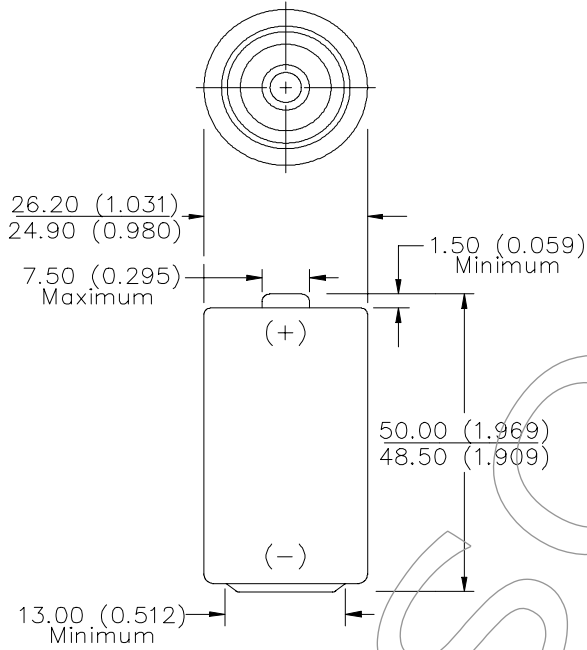

Industry Standard Dimensions in mm (inches)



Negative cover detail referenced on page 2

C

Chemical System: Alkaline
 Zinc-Manganese Dioxide (Zn/MnO₂)
 (No Added Mercury or Cadmium)

Designation: ANSI-14A, IEC-LR14

Battery Voltage: 1.5 Volts

Internal Resistance: 324 Milliohms (Fresh)

Operating Temp: -18°C to 55°C (0°F to 130°F)

Average Capacity: 9,150 mAh (to 0.8 volts)
 (Rated capacity at 25 mA continuous drain)

Average Weight: 66.2 grams (2.3 oz.)

Volume: 26.9 cubic centimeters (1.6 cubic inch)

Cell: One No. X3-335 (size 'C')

Jacket: Plastic Label

Shelf Life: 7 years (80% of rated capacity)

TEMPERATURE EFFECTS Typical Service to 0.8 Volts

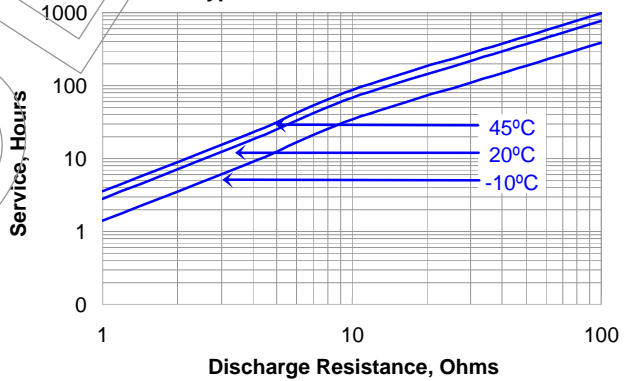

CONSTANT RESISTANCE PERFORMANCE Typical Service

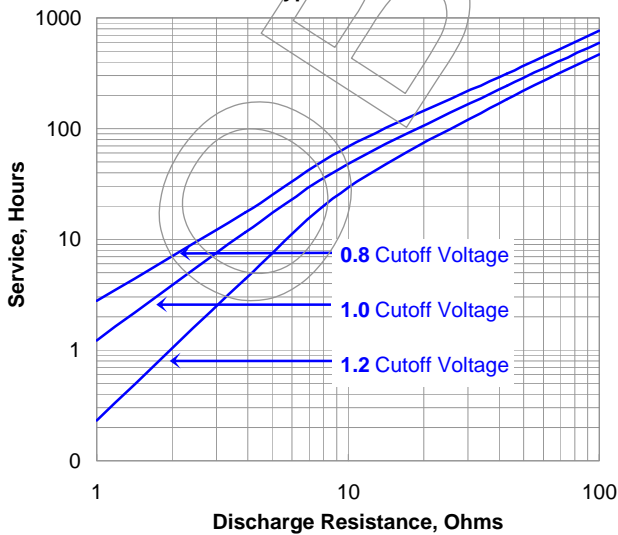

CONSTANT CURRENT DISCHARGE Typical Service

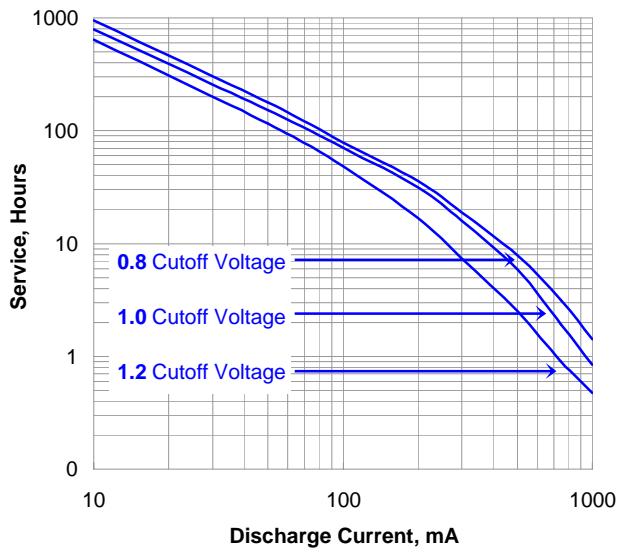

Important Notice

This data sheet contains information specific to batteries manufactured at the time of its publication.

Contents herein do not constitute a warranty.

Copyright © Eveready Battery Co. - All rights reserved

ENERGIZER NO. X93

Industry Standard Tests @ 20° C

TOY
3.9 ohm - 1 hr/day

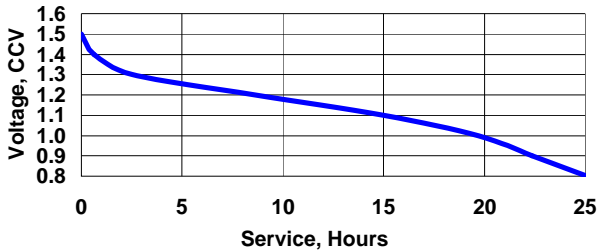

PORTABLE LIGHTING
3.9 ohm - LIF

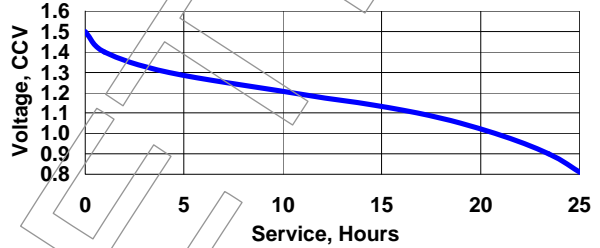

PORTABLE STEREO
400 mA - 2 hr/day

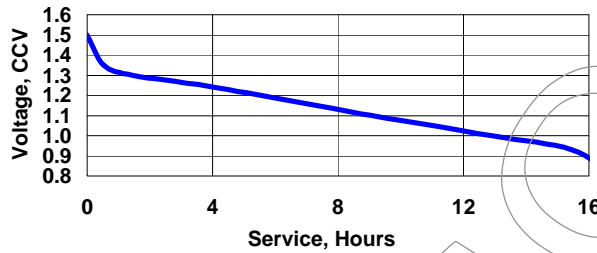

RADIO
20 ohm - 4 hr/day

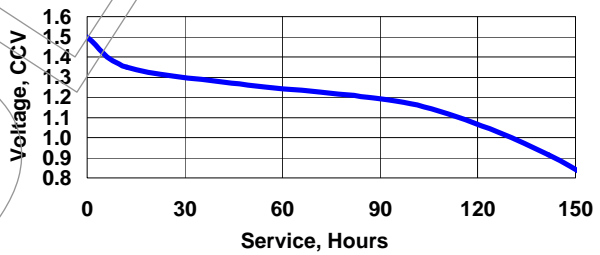

Important Notice

This data sheet contains information specific to batteries manufactured at the time of its publication.

Contents herein do not constitute a warranty.

Copyright © Eveready Battery Co. - All rights reserved