

# Model: TLP-96111/A/S

- HIGH ENERGY
- UP TO 3A PULSE CAPABILITY
- INSTANT VOLTAGE RESPONSE
- SAFER THAN SPIRAL WOUND CELLS

## TADIRAN LITHIUM BATTERIES

### PERFORMANCE DATA @ 25°C:

■ Capacity to 3.0 V (@ 100 mA @ 1% duty cycle)	1.1 Ah
■ Open circuit voltage	3.67 V
■ Maximum 1 second pulse to 3.0 V	3 A
■ Delay time to 3.0 V (@ 400 mA after 1 year)	<1 msec.
■ Weight	37 gr.
■ Capacity retention after 10 years	85%
■ Operating temperature	-40°C to +85°C

Preliminary Issue

### VOLTAGE VS. PULSE WIDTH

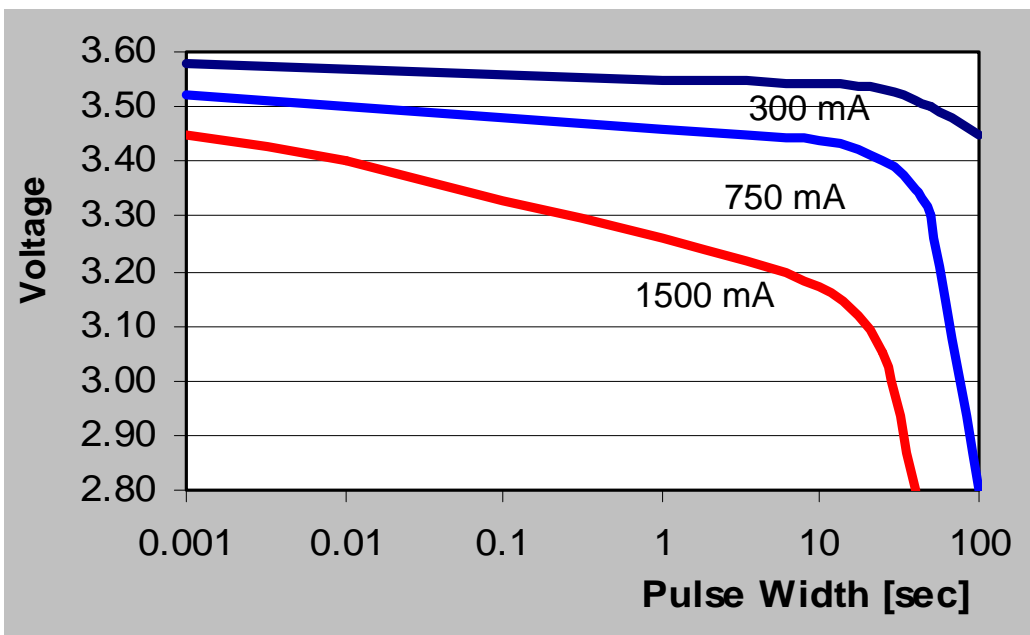

### Available Terminations:

TLP-96111/A/S  
Standard  
Cat. No. 61961111400

NOTE:  
SPECIAL CONNECTORS ARE  
AVAILABLE UPON REQUEST.

PATENTED TECHNOLOGY

**PulsesPlus** For High Pulse-Current Applications

Any representation in this brochure concerning performance are for information purposes only and not warranties, either expressed or implied, of future performance.

# Model: TLP-96111/A/S

# TADIRAN LITHIUM BATTERIES

## DISCHARGE CHARACTERISTICS @ 25°C

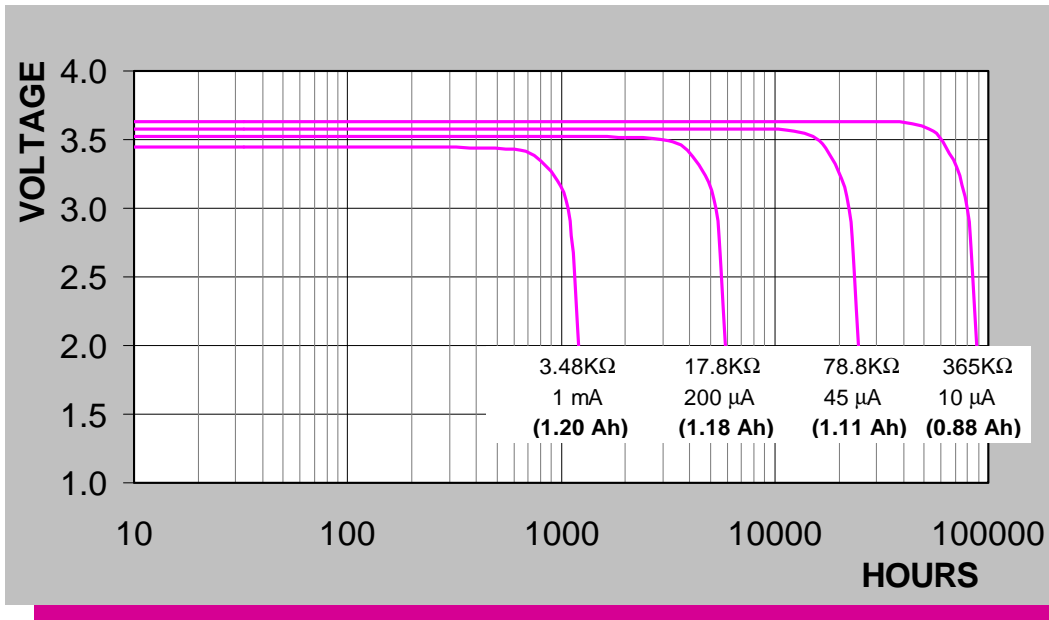

PATENTED TECHNOLOGY

**PulsesPlus** For High Pulse-Current Applications

Any representation in this brochure concerning performance are for information purposes only and not warranties, either expressed or implied, of future performance.

## Minimum Voltage vs. Temp. for 1 sec Pulse Width

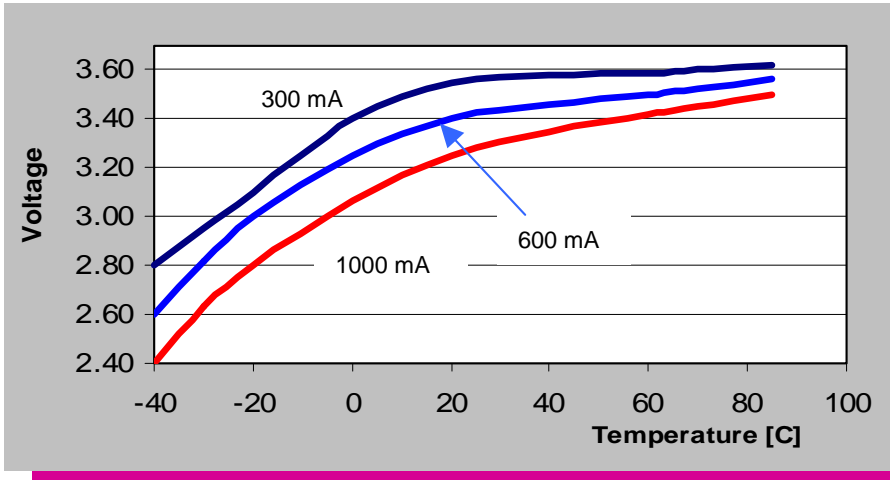

**TADIRAN**  
**LITHIUM**  
**BATTERIES**

**TLP-96111/A/S**

## Capacity Retention vs. Temperature

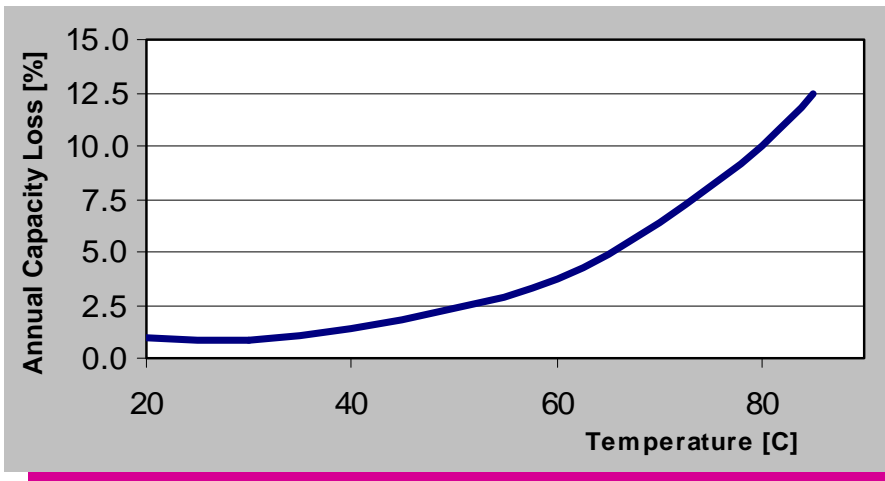

## Maximum Pulse Width to Min. Voltage of 3.0V at RT



PATENTED TECHNOLOGY

**PulsesPlus** For High Pulse-Current Applications

Any representation in this brochure concerning performance are for information purposes only and not warranties, either expressed or implied, of future performance.

# Model: TLP-96111/A/S

# TADIRAN LITHIUM BATTERIES

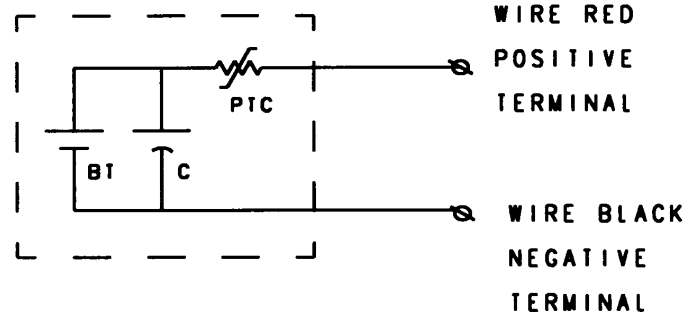
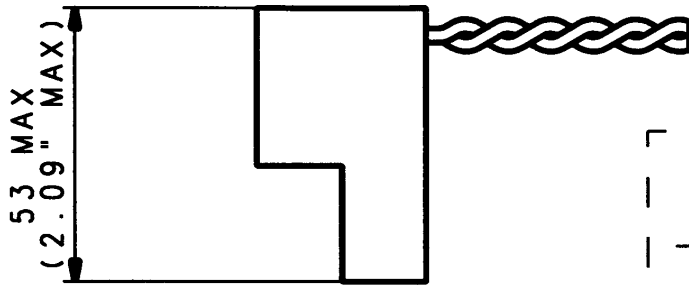

BT: TL-5902  
C: HLC-1550  
PTC: SRP 200

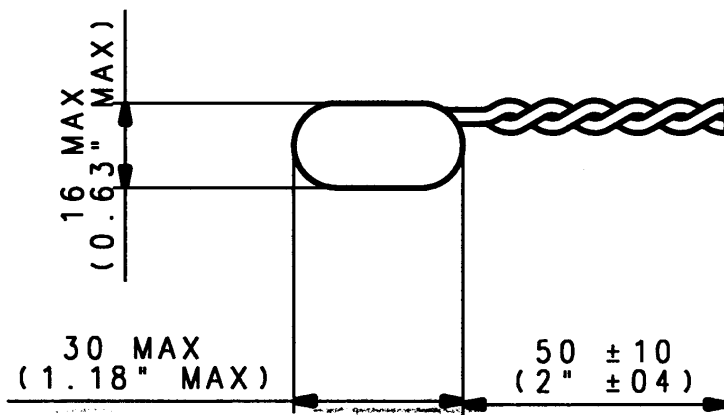

PATENTED TECHNOLOGY

**PulsesPlus** For High Pulse-Current Applications

Any representation in this brochure concerning performance are for information purposes only and not warranties, either expressed or implied, of future performance.