

Introduction	1
Introduction	1
Microchip Internet Connections	2
Emulator Systems	3
MPLAB [®] ICE 2000 Modular In-Circuit Emulator	5
MPLAB ICE 4000 Modular In-Circuit Emulator	6
MPLAB ICE 2000/4000 Replacement Accessories	7
Software Tools	9
MPLAB Integrated Development Environment (IDE)	11
Application Maestro [™] Software.....	12
MPLAB Visual Initializer Software.....	13
MPLAB C17 C Compiler	14
MPLAB C18 C Compiler	15
MPLAB C30 C Compiler	16
dsPIC30F Software Libraries	17
dsPICworks [™] Visual Algorithm Analyzer	18
Visual Digital Filter Designer	19
KEELOQ [®] License CD	20
FilterLab [®] Active Filter Software Design Tool	21
Total Endurance [™] Software Model	22
PICmicro[®] Programmer Systems	23
PICKit [®] 1 FLASH Starter Kit	25
rfPIC Development Kit 1.....	26
PICSTART [®] Plus Low-Cost Development Kit	27
PRO MATE [®] II Device Programmer	28
In-Circuit Serial Programming [™] (ICSP [™]) Socket for PRO MATE II	29
Programmer Adapter Kits and Accessories	30
In-Circuit Debugger	31
MPLAB ICD 2 In-Circuit Debugger	33
MPLAB ICD 2 Accessories	34
Demo Boards and Evaluation Kits	35
PICmicro[®] Demonstration Kits	
PICDEM [™] Demonstration Boards	37
PICDEM 2 Plus Demonstration Board	38
PICDEM 4 Demonstration Board	39
PICDEM 18R Demonstration Kit	40
PIC18F2539 Motor Control Evaluation Kit	41
PIC18FXX20 64/80L TQFP Demonstration Board	42

Development Tools Ordering Guide

Connectivity Demonstration Kits

PICDEM USB Demonstration Kit	43
PICDEM CAN-LIN 1 and PICDEM CAN-LIN 2 Demonstration Boards	44
PICDEM LIN Demonstration Kit	45
PICDEM.net™ Demonstration/Evaluation Board	46
MCP2510 CAN Developer's Kit	47
MCP250XX CAN I/O Expander Developer's Kit	48
MCP2120/2150 Infrared Developer's Kit	49

Analog and Mixed Special Demonstration Kits

PICDEM MSC1 Demonstration Kit	50
PICDEM MSC1 Daughter Boards	51
MCP41XXX/42XXX Digital Potentiometer Evaluation Board	52
MXDEV® 1 Analog Evaluation System Driver Board	53
MXDEV 1 MCP3XXX Single/Dual ADC Evaluation System Daughter Board Kit	54
MXDEV 1 MCP3XXX Quad/Octal ADC Evaluation System Daughter Board Kit	55
TC642EV – Evaluation Kit for Brushless DC Fan Controllers	56
TC642DEMO – Fan Controller Demo Board for TC642/646/647/648/649	56
TC650DEMO – Fan Controller Demo Board for TC650/651	56
TC652DEMO – Fan Controller Demo Board for TC652/653	56
TC74DEMO – Serial Digital Temperature Sensor Demo Board	56

dsPIC® Demonstration/Development Kits

dsPICDEM™ Starter Demonstration Board	57
dsPICDEM 1.1 General Purpose Development Board	58
dsPICDEM MC1 Motor Control Development Board	59
dsPICDEM.net™ 1 and dsPICDEM.net 2 Connectivity Development Boards	60

KEELOQ® Evaluation Kits

KEELOQ Transponder Evaluation Kit	61
KEELOQ Evaluation Kit II	62

Memory and RFID Developer's Kits

SEEVAL® 32 Serial EEPROM Designer's Kit	63
microID® Programmer Kits	64
125 kHz microID Developer's Kit for MCRF200/202	65
125 kHz Anticollision microID Developer's Kit for MCRF250	66
13.56 MHz Anticollision microID Developer's Kit for MCRF355 and MCRF360	67
13.56 MHz Anticollision microID Developer's Kit for MCRF355, MCRF360 and MCRF45X	68

PowerSmart® Evaluation Kits

PowerSmart Battery Manager Evaluation Kit for 3 or 4 Series Cell Lithium Ion/Polymer Chemistries	69
PowerSmart Battery Manager Evaluation Kit for Nickel Chemistries	70
PowerSmart Battery Monitor Evaluation Kit for 1 and 2 Series Cell Lithium Ion/Polymer Chemistries	71

Development Tools Cross Reference and Ordering Information73

Worldwide Sales and Service94

Photographs and contents are for illustration only.

Microchip Technology Inc. reserves the right to change product specifications without notice.

Introduction

Whether you're new to Microchip Technology Incorporated development system products or quite familiar with them, you'll find the **Development Tools Ordering Guide** to be very helpful. The table of contents provides an overview of the system products covered in the guide. There are a number of new development tools and kits in this edition to support Microchip's expanding device families. For current information on support products, please check Microchip's web site (www.microchip.com).

Microchip Technology Service and Support

Quality

Design and manufacturing continuous improvement processes are put in place to ensure high quality in Microchip Development Systems product offerings.

Warranty

Development system products are warranted against defects for one (1) year (90 days for those products that we normally sell for \$500 or less (USD), excluding promotional pricing).

Upgrade

Software upgrades are available free-of-charge from the Microchip web site (www.microchip.com). Hardware enhancements are also available free-of-charge or at a nominal fee. Contact your local distributor for more information.

Service

Efficient system service is essential – customers depend on our systems to design and program PICmicro[®] microcontrollers (MCUs) or memory-based systems. Defective components are typically replaced within 48 hours. Microchip's Service Center in Tempe, Arizona serves customers in the US and Canada. Our Winnersh, UK Service Center provides service to customers in Europe, the Middle East and Africa. The Far East sales offices provide these services directly.

July 2003

INTRODUCTION

Microchip Internet Connections

On-Line Support

Microchip provides on-line support on the Microchip web site at:

www.microchip.com

The web site provides a variety of services. Users may download files for the latest development tools, data sheets, application notes, user's guides, articles and sample programs. A variety of Microchip specific business information is also available, including listings of Microchip sales offices and distributors. Other information available on the web site includes:

- Latest Microchip press releases
- Technical support section with FAQs
- Design tips
- Device errata
- Job postings
- Microchip consultant program member listing
- Links to other useful web sites related to Microchip products
- Conferences for products, development systems, technical information and more
- Listing of seminars and events

Systems Information and Upgrade Hot Line

The Systems Information and Upgrade Information Line provides system users with a listing of the latest versions of all of Microchip's development systems software products. Plus, this line provides information on how customers can receive the most current upgrade kits. The Information Line Numbers are:

1-800-755-2345 for U.S. and most of Canada.

1-480-792-7302 for the rest of the world.

Key to Kit Contents



Enclosed Development Tool



Electronic Board

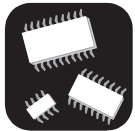

Samples



CD-ROM



Hook-up Cable(s)



Power Supply



Printed Documentation



World Wide Web

July 2003

EMULATOR SYSTEMS

Development Tools Ordering Guide

NOTES:



MPLAB[®] ICE 2000 Modular In-Circuit Emulator



Microchip's universal MPLAB ICE for PICmicro[®] MCUs has been designed with user requirements in mind. The system is small, portable, lightweight and

offers improved performance and value. For quick hook-up to portable or desktop PCs, MPLAB ICE easily connects to the parallel (printer) port.

Interchangeable processor modules allow the system to be easily configured to emulate different processors. This modular system consists of an emulator pod, a processor module, a device adapter and a transition socket (optional). Also included is Microchip's MPLAB Integrated Development Environment (IDE) featuring MPASM[™] macro assembler, MPLAB programmer's editor, symbolic debugger, and project manager with built-in support for high-level languages that support the Common Object Description format (i.e., MPASM assembler, MPLAB C17 and MPLAB C18).

MPLAB ICE 2000 is a premium quality emulator system providing full-speed emulation, low-voltage operation, 32K x 128-bit trace and unlimited breakpoints. Complex triggering of the MPLAB ICE 2000 provides sophisticated trace analysis and precision breakpoints. The trace analyzer captures real-time execution addresses, opcodes and read/writes of external data. It also traces all file register RAM usage showing internal addresses and data values, as well as all accesses to special function registers, including I/O, timers and peripherals.

Triggers and breakpoints can be set on single events, multiple events and sequences of events. The MPLAB ICE 2000 analyzer is fully transparent and does not require halting the processor to view the trace. In addition, MPLAB ICE 2000 supports code coverage profiling.

Features

- Full Speed Real-Time Emulation
- Low Voltage Emulation: 2.0V to 5.5V
- Trace Memory: 32K x 128-bit
- Break/Trigger on Internal Registers
- Program Address Software Breakpoints
- Complex Break/Trigger on Logic: Program Address and Data; Internal Register Address and Data; Access Type; and Eight External Inputs
- One External Input and Output Logic Analyzer Trigger
- Multi-level Trigger (4 levels)
- Pass and Delay Counters
- Time Stamp
- Programmable Clock: 32 kHz to 40 MHz
- Logic Probes
- Parallel (printer) Port Communications
- Code Coverage Profiling

MPLAB ICE 2000 In-Circuit Emulator Contents

- MPLAB ICE 2000 with Tripod
- MPLAB IDE Software and Documentation CD
- Logic Probes
- Parallel Cable
- Power Supply

Ordering Part Number:

ICE2000 MPLAB ICE 2000 Modular In-Circuit Emulator Pod (see ordering instructions on page 75)

Development Tools Ordering Guide



MPLAB[®] ICE 4000 Modular In-Circuit Emulator

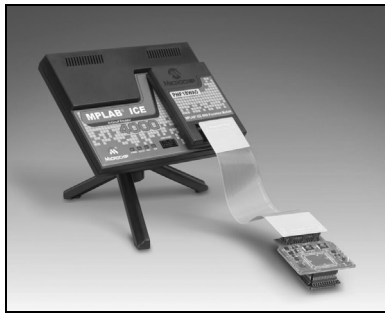

The MPLAB ICE 4000 in-circuit emulator is intended to provide the product development engineer with a complete microcontroller design tool set for high-end PICmicro[®]

microcontrollers. Software control of the emulator is provided by the MPLAB Integrated Development Environment, which allows editing, building, downloading and source debugging from a single environment.

The MPLAB ICE 4000 is a premium emulator system providing the features of MPLAB ICE 2000, but with increased emulation memory and high speed performance for dsPIC30F and PIC18XXXX devices. Its advanced emulator features include complex triggering and timing, up to 2 MB of emulation memory, and the ability to view variables in real time.

The MPLAB ICE 4000 in-circuit emulator system has been designed as a real-time emulation system with advanced features that are typically found on more expensive development tools. The PC platform and Microsoft Windows[®] 32-bit operating system were chosen to best make these features available in a simple, unified application.

Features

- Full Speed Emulation
- Low voltage emulation down to 1.8 volts (or device limit)
- 64K deep x 216-bit wide Trace Memory
- Up to 2 MB of addressable memory
- Unlimited breakpoints
- Complex break, trace and trigger logic
- Multi-level trigger up to 4 levels
- 48-bit time stamp
- Stopwatch
- External inputs
- External output to sync with other instrumentation
- USB port and parallel port* connection to PC

*Feature to be available later with software upgrade

MPLAB ICE 4000 In-Circuit Emulator Contents

- MPLAB ICE 4000
- MPLAB IDE Software and Documentation CD
- Flex Cable
- Logic Probes
- USB Cable
- Power Supply

Ordering Part Number:

ICE4000 MPLAB ICE 4000 Modular In-Circuit Emulator (see ordering instructions on page 75)

MPLAB® ICE 2000/4000 Replacement Accessories

Device Adapter Plugs

Device adapter plugs are available as replacement accessories. The table below lists the replacement part number.

Model Part Number	Description
ACICE0201	MPLAB ICE 8P 300 mil adapter plug
ACICE0202	MPLAB ICE 18P 300 mil adapter plug
ACICE0203	MPLAB ICE 20P 300 mil adapter plug
ACICE0204	MPLAB ICE 28P 300 mil adapter plug
ACICE0205	MPLAB ICE 28P 600 mil adapter plug
ACICE0206	MPLAB ICE 40P 600 mil adapter plug
ACICE0207	MPLAB ICE 14P 300 mil adapter plug

Transition Headers

Transition socket headers can be purchased separately in the event that a customer needs additional headers. The table below lists the headers available.

Model Part Number	Description
ACICE0301	8P SOIC Header
ACICE0302	14P SOIC Header
ACICE0303	18P SOIC Header
ACICE0305	20P SOIC Header
ACICE0306	28P SOIC Header
ACICE0307	28P SSOP Header

MPLAB ICE 2000 Replacement Accessories

Model Part Number	Description
ACICE0103	MPLAB ICE 2000 Power Supply
ACICE0104	MPLAB ICE 2000 Logic Probes
ACICE0105	MPLAB ICE 2000 Parallel Cable
ACICE0106	MPLAB ICE Tripod
ACICE0107	MPLAB ICE 2000 Flex Cable

MPLAB ICE 4000 Replacement Accessories

Model Part Number	Description
ACICE0401	MPLAB ICE 4000 Power Supply
ACICE0402	MPLAB ICE 4000 Logic Probes
ACICE0403	MPLAB ICE 4000 Slim Parallel Cable
ACICE0106	MPLAB ICE Tripod
ACICE0407	MPLAB ICE 4000 Flex Cable

Extra logic probe hooks can be purchased from:

E-Z-Hook: (800) 995-HOOK

Part Number: XM25

Description: Micro Hook Adapter with 0.025 square pin

Development Tools Ordering Guide

NOTES:

July 2003

SOFTWARE TOOLS

Key to Kit Contents



Enclosed Development Tool



Electronic Board



Samples



CD



Hook-up Cable(s)



Power Supply



Printed Documentation



World Wide Web

Development Tools Ordering Guide

NOTES:



MPLAB[®] Integrated Development Environment (IDE)

MPLAB IDE gives PICmicro[®] MCU users the flexibility to edit, compile and debug from a single user interface.

MPLAB IDE allows you to write, debug and optimize the PICmicro MCU applications for firmware product designs. MPLAB IDE is a Windows[®] based development platform featuring a project manager and program text editor, a user-configurable toolbar containing four pre-defined sets and a status bar which communicates editing and debugging information.

MPLAB IDE is the common user interface for Microchip development systems tools including MPLAB Editor, MPASM[™] Assembler, MPLAB SIM Software Simulator, MPLIB[™] Library, MPLINK[™] Linker, MPLAB C17 C Compiler, MPLAB C18 C Compiler, MPLAB ICE, PICSTART[®] Plus Development Programmer, PRO MATE[®] II Programmer and MPLAB ICD. Additional products may become available as add-on tools in the future.

The MPLAB IDE desktop provides the development environment and tools for developing and debugging your application as a project, allowing you to quickly move between different development and debugging modes. With the MPLAB IDE environment, you can write and debug your source code, automatically locate errors in source files for editing, debug with breakpoints based on internal register values, watch the program flow with MPLAB SIM (software simulator) or MPLAB ICE, make timing measurements with a "time stamp," view variables in watch windows, program firmware with PICSTART Plus or PRO MATE II programmers and find quick answers to questions from the MPLAB IDE on-line help.

Features

- Full featured, color coded text editor
- Easy to use project manager with visual display
- Source level debugging
- Enhanced source level debugging for 'C' structures, automatic variables, etc.
- Customizable toolbar and key mapping
- Dynamic status bar displays processor condition at a glance
- Context sensitive, interactive on-line help
- Integrated MPLAB SIM instruction simulator
- User interface for PRO MATE II and PICSTART Plus device programmers
- User interface for MPLAB ICE 2000 or MPLAB ICE 4000 In-Circuit Emulator
- User interface for MPLAB ICD 2 In-Circuit Debugger

Ordering Part Number:

Available on the Microchip web site at: www.microchip.com.

Development Tools Ordering Guide



Application Maestro™ Software

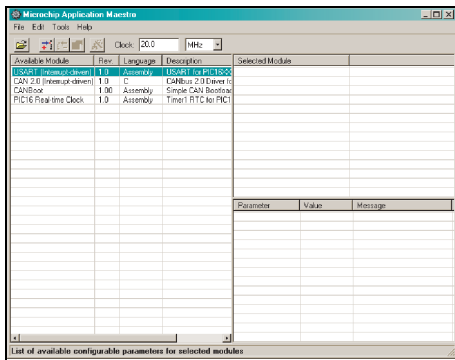

The Microchip Application Maestro Software is a stand-alone software tool that allows users to configure and incorporate a range of pre-written

firmware modules into their applications. Its heart is a collection of modules developed by Microchip Technology for use with its PICmicro® microcontrollers. Starting from a graphic interface, the user selects one or more available modules, then configures the parameters for each. When this is complete, the Application Maestro Software then generates code that can be incorporated into the user's application project, using MPLAB® IDE or any compatible development environment.

It is important to note that the Application Maestro Software is not a plug-in or add-on to the MPLAB line of development tools; it is a separate item in its own right. Application Maestro Software also differs from other librarian systems, such as MPLIB™ Library, because it does more than archive and manage related files for a single software project. Instead, it manages a library of ready-to-configure modules that the user customizes to their needs, and creates the necessary files for inclusion in the user's projects on demand.

Ordering Part Number:

Available on the Microchip web site at: www.microchip.com (Free Download).



MPLAB® Visual Initializer Software

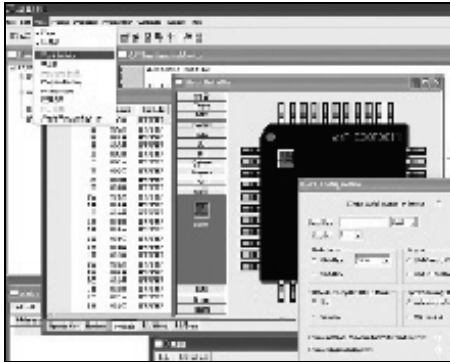

Configuring a powerful 16-bit MCU or DSP can be a complex and challenging task, but not with the dsPIC30F. Microchip's MPLAB Visual Initializer

Features

- Drag and drop feature selection
- One click configuration
- Extensive error checking
- Generates initialization code
- Integrates seamlessly in MPLAB project
- Printed reports eases project documentation requirements

allows users to configure the entire processor graphically, and when complete, a mouse click generates code usable in Assembly or C programs.

MPLAB Visual Initializer does extensive error checking on assignments and conflicts on pins, memories and interrupts as well as selection of operating conditions. The generated code files are seamlessly integrated with the rest of the application code through MPLAB project.

The detailed reports on resource assignment and configuration simplifies project documentation.

Ordering Part Number:

Available on the Microchip web site at: www.microchip.com (Free Download).

Estimated Availability: Q3 2003

Development Tools Ordering Guide



MPLAB® C17 C Compiler

MPLAB C17 provides powerful integration capabilities and ease of use.

The MPLAB C17 is a full-featured, ANSI-compliant C compiler for the PIC17CXXX MCU family. MPLAB C17 is fully compatible with Microchip's MPLAB IDE, allowing source level debugging with both MPLAB ICE and MPLAB SIM. MPLAB IDE provides a convenient, project oriented development environment that reduces development time.

MPLAB C17 allows code for the PIC17CXXX family to be written in the C high-level language using powerful PICmicro® MCU libraries, enabling the developer to devote more time to the application and less time to the details of the processor.

MPLAB C17 was designed explicitly for the PIC17CXXX family and allows the use of a software stack for maximum RAM reusability or can be run without a stack for optimal code space efficiency.

MPLAB C17 provides user configurable interrupt support macros for saving and restoring context during interrupt handling. Libraries and interrupt handlers are provided for multiple memory models. Libraries, precompiled objects and linker scripts can be included in MPLAB IDE projects along with C and Assembly source files for use with MPLAB IDE make and build functions.

The MPLAB C17 ANSI-compliant C compiler comes complete with the MPLAB IDE. The IDE allows you to quickly move between different development and debugging modes. For example, you can quickly advance from software debugging with MPLAB SIM simulator to hardware debugging with MPLAB ICE.

MPLAB C17 has implemented extensions to the C language to provide specific support for Microchip's PICmicro MCU environment.

These C library extensions include:

A/D Converter	Input Capture
SPI™	Timers
I ² C™	I/O Port
Reset	External LCD
Software I ² C	Software USART
Relay	Memory/String Manipulation
32-bit Math Library	Interrupt Support Macros
USART	Character Classification
Pulse Width Modulation	Number/Text Conversion
Software SPI	

MPLAB C17 will run on any 486 or better PC, on MS-DOS 5.0+ or as a native 32-bit Windows® 95 or Windows NT® executable.

MPLAB C17 C Compiler Contents

- MPLAB C17 C Compiler Software
- MPLAB IDE Software and Documentation CD
- *MPLAB C17 Compiler User's Guide* and *MPLAB C17 Compiler Libraries Manuals*
- Complete Documentation

Ordering Part Number:

SW006010 MPLAB C17 C Compiler

A 60-day free demo is available from the Microchip web site at www.microchip.com.



MPLAB® C18 C Compiler

The MPLAB C18 is a full-featured ANSI-compliant C compiler for the Microchip Technology PIC18CXXX family of PICmicro® MCUs. MPLAB C18 is fully compatible with Microchip's MPLAB IDE, allowing source level debugging with both the MPLAB ICE and the MPLAB SIM simulator. MPLAB C18 provides a convenient, project oriented development environment that reduces development time.

MPLAB C18 allows code for the PIC18CXXX family to be written in the C high-level language using powerful PICmicro MCU libraries, enabling the developer to devote more time to the application and less time to the details of the processor.

MPLAB C18 was designed explicitly for the PIC18CXXX family and allows the use of a software stack for maximum RAM reusability.

MPLAB C18 provides user configurable interrupt support for saving and restoring context during interrupt handling. Libraries are provided for multiple memory models. Libraries, precompiled objects and linker scripts can be included in MPLAB C18 projects along with C and Assembly source files for use with MPLAB C18 make and build functions.

The MPLAB C18 ANSI-compliant C compiler comes complete with the MPLAB IDE. The IDE allows you to quickly move between different development and debugging modes. For example, you can quickly advance from software debugging with MPLAB SIM simulator to hardware debugging with MPLAB ICE.

MPLAB C18 has implemented extensions to the C language to provide specific support for Microchip's PICmicro MCU environment.

These C library extensions include:

A/D Converter	Input Capture
SPI™	Timers
I ² C™	I/O Port
Reset	External LCD
Software I ² C	Software USART
Relay	Memory/String Manipulation
32-bit Math Library	Interrupt Support Macros
USART	Character Classification
Pulse Width Modulation	Number/Text Conversion
Software SPI	

MPLAB C18 will run on any 486 or better PC, as a native 32-bit Windows® 95 or Windows NT® executable.

MPLAB C18 C Compiler Contents

- MPLAB C18 C Compiler Software
- MPLAB IDE Software and Documentation CD
- *MPLAB C18 Compiler User's Guide* and *MPLAB C18 Compiler Libraries Manuals*
- Complete Documentation

Ordering Part Number:

SW006011 MPLAB C18 C Compiler

A 60-day free demo is available from the Microchip web site at www.microchip.com.

Development Tools Ordering Guide



MPLAB[®] C30 C Compiler

The MPLAB C30 C compiler is a fully ANSI compliant product with standard libraries for the dsPIC[®] architecture. It is highly optimizing and takes advantage of many dsPIC architecture specific features to provide efficient software code generation. MPLAB C30 also provides extensions that allow for excellent support of the hardware, such as interrupts and peripherals. It is fully integrated with the MPLAB IDE for high level, source debugging.

Features

- 16-bit native data types
- Efficient use of register based, 3-operand instructions
- Complex Addressing modes
- Efficient multi-bit shift operations
- Efficient signed/unsigned comparisons

MPLAB C30 comes complete with its own assembler, linker and librarian. These allow the user to write Mixed mode C and assembly programs and link the resulting object files into a single executable file.

MPLAB C30 C Compiler Contents

- MPLAB C30 C Compiler Software
- MPLAB IDE Software and Documentation CD
- *MPLAB C30 Compiler User's Guide* (on CD) and Complete Documentation

Ordering Part Number:

SW006012 MPLAB C30 C Compiler

Estimated Availability: Q3 2003



dsPIC30F Software Libraries

Math Library

This IEEE-754 compliant library provides ANSI C standard math functions for floating-point and double precision data types. These routines have been optimized to provide the smallest code size. The library functions can be called by Assembly or C code. Key functions include:

- sin, cos, tan
- asin, acos, atan
- ln, log10, sqrt, pow, alog10
- ceil, floor, mod, frexp

DSP Algorithm Library

This extensive DSP building block library is fully optimized in assembly code for execution speed. The DSP functions can be used in Assembly or C. Scope includes:

- Matrix and vector functions
- Filtering functions – IIR, FIR, LMS
- Transform functions – FFT, DCT
- Correlation, Convolution and Window functions

Peripheral Driver Library

This library, containing over 270 C functions, helps you set up and operate the hardware peripheral modules including:

- 10-bit and 12-bit ADC
- UART, SPI™ and I²C™
- Motor control PWM and QEI
- General purpose timers
- Input capture and Output compare
- Reset/control
- External and Change Notification interrupts
- CAN
- DCI
- External LCD drivers - also included in the library

Ordering Part Number:

SW300020	dsPIC30F Math Library
SW300021	dsPIC30F Peripheral Driver Library
SW300022	dsPIC30F Algorithm Library

Estimated Availability: Q3 2003

Development Tools Ordering Guide



dsPICworks™ Visual Algorithm Analyzer

dsPICworks Visual DSP tool makes it easy to evaluate and analyze DSP algorithms. A variety of DSP operations can be run and data analyzed in the time or frequency domain.

Features

- Visually analyze time and frequency domain data
- DSP Operations: FFT, convolution, correlation
- Waveform synthesis
- Real-time data acquisition capabilities
- Import data directly from MPLAB IDE

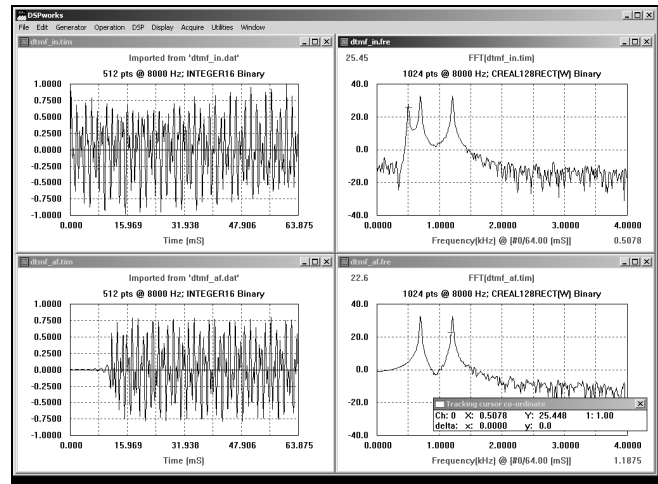

Ordering Part Number:

SW300023 dsPICworks – Visual Algorithm Analyzer

Estimated Availability: Q3 2003



Visual Digital Filter Designer

The Visual Filter Designer tool for dsPIC[®] microcontrollers makes designing and analyzing Finite Impulse Response (FIR) and Infinite Impulse Response (IIR) filters easy. Enter frequency specifications and filter code and coefficients are generated automatically. Graphical output windows provide the desired filters characteristics.

Features

- Lowpass, highpass, bandpass and bandstop filter support
- FIR filters with up to 513 taps
- IIR filter with up to 10 taps for lowpass and highpass filters
- IIR filter with up to 20 taps for bandpass and bandstop filters
- Generates dsPIC30F assembly code and filter coefficient files for export to MPLAB IDE or MPLAB C30 C Compiler

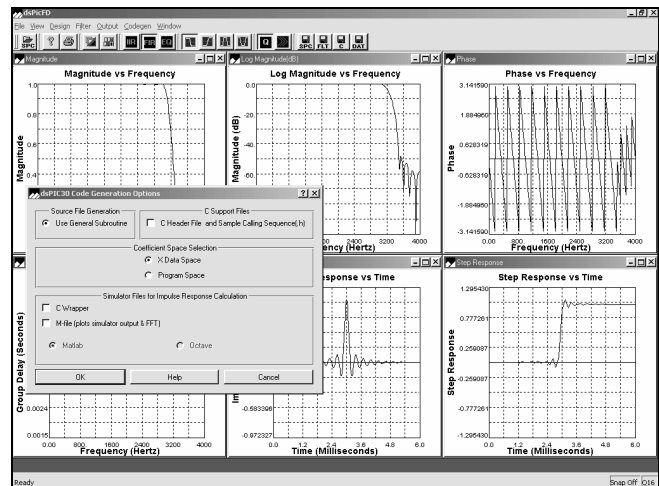

Ordering Part Number:

SW300001 Visual Digital Filter Designer

Estimated Availability: Q3 2003

Development Tools Ordering Guide



KEELOQ[®] License CD

The KEELOQ License CD contains KEELOQ application notes, decoder software and the KEELOQ Software Toolkit. Also included are KEELOQ data sheets, development tools documentation and MPLAB[®] IDE software.

The KEELOQ Software Toolkit is a tool that is designed to be used by a KEELOQ system developer to debug code. The toolkit allows the user to receive KEELOQ transmissions from the KEELOQ Evaluation Kit II (DM303006) and the KEELOQ Transponder Evaluation Kit (DM303005).

The KEELOQ Decoder software is typically used as the starting point of a decoder design. The software is fully described in the application notes accompanying the software.

Ordering Part Number:

DS40038

KEELOQ License CD

Available from Microchip at: lit_inquiry@microchip.com (Americas & Canada),
euro.inquiry@microchip.com (Europe) or asia.inquiry@microchip.com (Far East).



FilterLab[®] Active Filter Software Design Tool

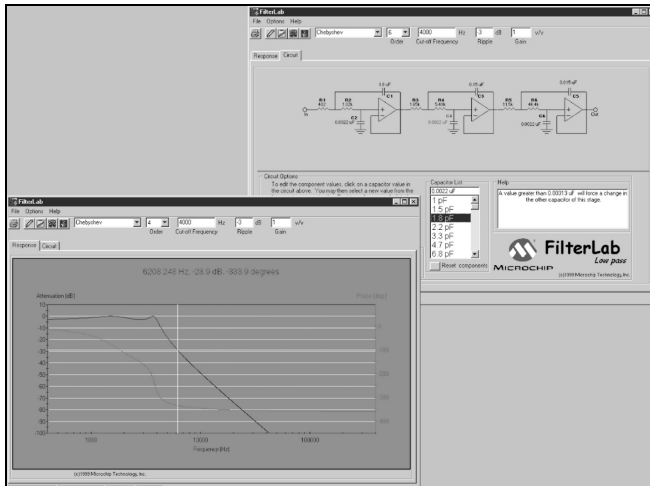

FilterLab is an innovative software tool that simplifies active filter design. The FilterLab active filter software design tool provides full schematic diagrams of the filter circuit with component values and displays the frequency response.

Features

- Multiple Filter Order and Responses with Gain Option
 - Ability to select Bessel, Butterworth or Chebyshev filter response
 - Up to 8th-order filters can be simulated
 - Circuit diagram and component values given
- Bode Plot with Phase Margin
 - Resultant Bode plot generated
- Circuit Implementation
 - Standard 1 percent resistors
 - Standard capacitor values generate and user adjustable
 - Circuit configuration: Sallen-Key (noninverting) or multiple feedback (inverting)
- Spice Model Generated
 - Spice Model of entire filter generated
 - Allows for streamline of simulations
- Anti-Aliasing Wizard
 - Filter optimization for Analog-to-Digital Converter based on bit resolution and sample rate.

Ordering Part Number:

Available on the Microchip web site at www.microchip.com (Free Dowload).



Total Endurance™ Software Model

Microchip's revolutionary Total Endurance Software Model provides electronic system designers with unprecedented visibility into Serial EEPROM-based applications. This advanced software model (with a very friendly user interface) eliminates time and guesswork from Serial EEPROM-based designs by accurately predicting the device's performance and reliability within a user-defined application environment. Design trade-off analysis which formerly consumed days or weeks can now be performed in minutes – with a level of accuracy that delivers a truly robust design.

With Microchip's Total Endurance Software Model, users may input the following application parameters:

- Serial EEPROM device type
- Bytes to be written per cycle
- Cycling mode – byte or page
- Data pattern type – random or worst-cast
- Temperature in °C
- Erase/Write cycles per day
- Application lifetime or target PPM level

The model will respond with FIT rate, PPM level, application life and plot of the PPM level versus number of cycles. The model is available in both MS-DOS and Windows® versions.

Features

- Automatic or manual recalculation
- Real-time update of data
- Full-screen or windowed graphical view
- Hypertext on-screen help
- Key or slide-bar entry of parameters
- On-screen editing of parameters
- Single-click copy of plot to clipboard
- Numeric export to delimited text file
- On-disk Endurance Tutorial

Ordering Part Number:

Available on the Microchip web site at www.microchip.com (Free Download).

July 2003

Key to Kit Contents



Enclosed Development Tool



Electronic Board



Samples



CD



Hook-up Cable(s)



Power Supply



Printed Documentation



World Wide Web

PROGRAMMER SYSTEMS
PICmicro®

Development Tools Ordering Guide

NOTES:



PICKit™ 1 FLASH Starter Kit

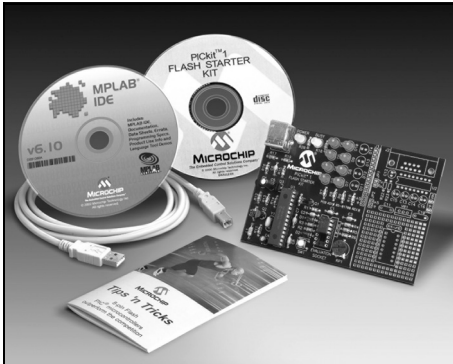

The PICKit 1 FLASH Starter Kit is a low-cost development kit with an easy to use interface for programming Microchip's 8/14-pin FLASH family

of microcontrollers. This starter kit is designed to help the user get up to speed quickly using PIC® microcontrollers.

The kit provides everything needed to program, evaluate and develop applications using Microchip's powerful 8/14-pin FLASH family of microcontrollers. Instructions are provided in a series of seven tutorials that cover I/O, Interrupts, A/D Converters, Comparators, Data Tables and Timers. All source code files for the tutorials are furnished.

Code development and debugging is performed using Microchip's powerful MPLAB® Integrated Development Environment (IDE). The MPLAB IDE is a seamless, integrated software development environment that includes a MPASM™ macro assembler, MPLAB SIM software simulator with symbolic debugger, color-coded source editor, project manager with high-level language debugging and concurrent support for development tools, including low-cost in-circuit debuggers, full-featured real-time emulators and programmers. The consistent and easy-to-use graphic user interface of the MPLAB desktop allows for rapid switching between development, debugging and programming modes within a project.

Features

- Small 3" x 4.5" circuit board with snap-off prototyping board
- Easy to use Windows® programming interface for programming Microchip's 8/14 pin FLASH family of microcontrollers
- Seven sequential tutorials written in both Assembly and HI-TECH C demonstrate how to use Microchip's 8/14 pin FLASH family of microcontrollers
- Microchip's Tips 'n Tricks Booklet provides efficient, low-cost design techniques using Microchip FLASH microcontrollers
- PICKit 1 User Guide (included on CD)
- Microchip's MPLAB IDE software for a complete code development environment
- HI-TECH PICC™ LITE C Compiler (contained on the MPLAB CD)

PICKit 1 FLASH Starter Kit Contents

- PICKit 1 Circuit Board with 8-pin PIC12F675
- PICKit 1 FLASH Starter Kit CD
- MPLAB IDE (Integrated Development Environment) CD
- Software and Hardware "Tips 'n Tricks" for 8-pin FLASH PIC Microcontrollers Booklet
- USB Interface Cable

Ordering Part Number:

DV164101 PICKit 1 FLASH Starter Kit

Development Tools Ordering Guide



rfPIC™ Development Kit 1



The rfPIC Development Kit provides design engineers with an easy way to evaluate unidirectional remote sense and control wireless links based on the rfPIC12F675 and

rfRXD0420/0920 devices. The kit is based on the popular PICkit™ 1 FLASH Starter Kit and consists of modular building blocks for different transmitters and receivers that can be utilized for prototype systems or to evaluate different options using Microchip products.

The receiver modules are based on the rfRXD0420 and rfRXD0920 devices and are available in two options supporting 315 MHz ASK and 433 MHz ASK. These modules plug directly into the PICkit 1 Development board offering an easy way to evaluate the different receiver modules with Microchip's 8- and 14-pin FLASH PIC® microcontrollers as well as a USB interface to a PC. The modules are also available for sale separately to allow a number of prototypes based on the same module without having to do an actual RF design. The design files for these modules are available to allow easy integration of the designs into a system.

The transmitter modules are based on the rfPIC12F675 devices and support the same frequency and modulation formats as the receivers. The transmitter modules feature button inputs for remote control functions as well as analog input to allow evaluation of the A/D and comparator peripherals on the rfPIC12F675. Code development is achieved with Microchip's MPLAB Integrated Development Environment (IDE). The microcontroller is easily programmed using the PICkit 1, with modules plugging into the PICkit in a similar manner as the receiver modules.

rfPIC Development Kit 1 Contents

- PICkit™ 1 FLASH Starter Kit
- 433.92 MHz Transmitter
- 315 MHz Transmitter
- 433.92 MHz Receiver
- 315 MHz Receiver
- rfPIC Software and Complete Documentation (on CD)

Ordering Part Number:

DV164102	rfPIC Development Kit 1
AC164101	rfPIC Transmitter Module (433.92 MHz)
AC164102	rfPIC Transmitter Module (315 MHz)
AC164103	rfPIC Receiver Module (433.92 MHz)
AC164104	rfPIC Receiver Module (315 MHz)
AC164105	rfPIC Receiver Module - 5 Pack (433.92 MHz)
AC164106	rfPIC Receiver Module - 5 Pack (315 MHz)

Estimated availability: Q3 2003



PICSTART® Plus Low-Cost Development Kit

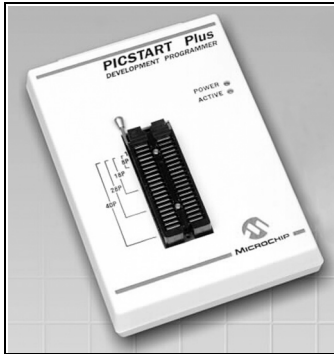

The PICSTART Plus programmer gives the product developer the ability to program user software into any of the supported microcontrollers. The PICSTART Plus software running under MPLAB® IDE provides for full interactive control over the programmer.

The PICSTART Plus programmer provides the product development engineer with a highly-flexible, low-cost design tool set for all PICmicro® MCUs (DIP packages up to 40 pins). PLCC and QFN Adapters are available.

The CE-compliant PICSTART Plus development programmer features a molded plastic enclosure and special circuit design techniques to enhance ESD protection. PICSTART Plus is a development programmer and is not recommended for use in a production environment.

Sample software programs are provided to help the developer quickly become familiar with the PICSTART Plus development system and with Microchip's PICmicro MCU families. Included is a limited C compiler (PICC LITE™) for the PIC16F84 family.

The MPASM™ macro assembler provides programmable memory data files, listing files and special files required for symbolic debug. The MPLAB SIM software simulator allows the user to isolate code problems and debug firmware designs on PICmicro MCUs. It simulates the core functions as well as most of the peripherals of the PICmicro MCU families. It is particularly suitable for optimizing algorithms where real-time emulation is not required.

The PICSTART Plus development system runs on any PC-compatible machine under Windows® 98 SE or later operating system. The easy-to-use PICSTART Plus software provides for full interactive control over the programmer and features Microchip's highly acclaimed MPLAB IDE, with its built-in editor, assembler and Windows based MPLAB SIM simulator.

PICSTART Plus Development Kit Contents

- PICSTART Plus Device Programmer
- Product Sample
- MPLAB IDE Software
- PICC LITE C Compiler
- RS-232 Interface Cable
- Power Supply
- Complete Documentation

Ordering Part Number:

DV003001	PICSTART Plus Programmer
AC164024	68-pin PLCC Adapter Kit for PIC16C92X and PIC17C75X
AC164027	84-pin PLCC Adapter Kit for PIC17C76X
AC164031	28-pin QFN Adapter

Development Tools Ordering Guide



PRO MATE® II Device Programmer

CE Compliant PRO MATE II makes programming easy.



Microchip's PRO MATE II Device Programmer makes it easy to program the company's entire line of PICmicro® MCUs, HCSXXX Security

Products and 2- and 3-wire Serial EEPROMs; operating either as a stand-alone unit or in conjunction with a PC-compatible host system. When connected to a host system, PRO MATE II provides an exceptionally user-friendly interface to give the developer complete control over the programming session. This time-saving tool comes complete with all the accessories needed to connect to a host system including interface cables and a universal input power supply.

In addition to the programmer unit, the PRO MATE II system contains Microchip's highly-acclaimed MPLAB® IDE, with its built-in editor, assembler, and Windows® based MPLAB SIM simulator. The PRO MATE II programmer includes full documentation and software.

The PRO MATE II software provides many user interface features. These include a "safe mode", where accidental corruption of master code is prevented, and the ability to save and restore "environment" settings. The PRO MATE II system runs with Microchip's popular MPLAB IDE software.

PRO MATE II is CE-compliant, meaning it meets or exceeds all the directives for safety, emissions, ESD and susceptibility (to radiated emission) requirements set forth by the European Union (EU) countries.

The PRO MATE II device programmer is designed to be robust and reliable with:

- Enhanced socket module alignment with four auto alignment pins
- Three levels of over-current protection and superior ESD immunity for rugged environments
- A small and compact universal IEC power supply
- Improved LCD display and buttons.

PRO MATE II Device Programmer Contents

- PRO MATE II Universal Device Programmer Unit
- PRO MATE and MPLAB IDE Software
- RS-232 Interface Cable
- Power Supply
- Complete Documentation

Ordering Part Number:

DV007003 PROMATE II

Socket Modules are sold separately. See *Development Tools Cross Reference*, page 76 for socket module ordering information.



In-Circuit Serial Programming™ (ICSP™) Socket for PRO MATE® II

Microchip offers an ICSP kit that can be used with PRO MATE II, Microchip's universal device programmer. Together, these two tools allow you to implement ICSP with minimal effort and use the ICSP capability of Microchip's PICmicro® MCUs.

In-System Programming is a technique where a programmable device is programmed after the device is placed in a circuit board. ICSP is an enhanced ISP technique implemented in Microchip's PICmicro OTP and FLASH MCUs. Using only two I/O pins to serially input and output data makes ICSP easy-to-use and less intrusive on the normal operation of the MCU.

The In-Circuit Serial Programming Socket module is a complete kit including connectors, cables, and required interface boards to allow a development engineer to implement ICSP with PRO MATE II.

ICSP Socket for PRO MATE II Contents

- ICSP Socket
- Cable
- Power Supply
- Complete Documentation

Ordering Part Number:

AC004004 ICSP Socket Module

PRO MATE II is sold separately. See *Development Tools Cross Reference*, page 76 for more information.

Development Tools Ordering Guide

Programmer Adapter Kits and Accessories

68-Pin PLCC Adapter Kit

PIC16C92X/PIC17C75X 68-Pin PLCC Adapter for PICSTART® Plus. Currently this header supports PIC16C92X and PIC17C75X.

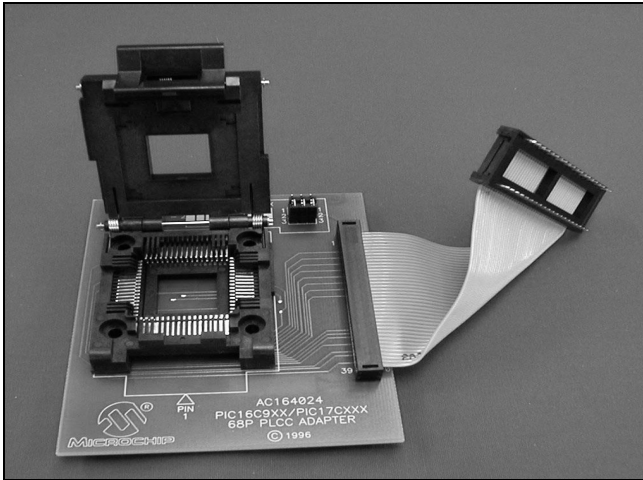

28-Pin QFN Adapter Kit

PIC16CXX 28-Pin QFN Adapter for PICSTART Plus and PRO MATE® II programmers (with AC164012).

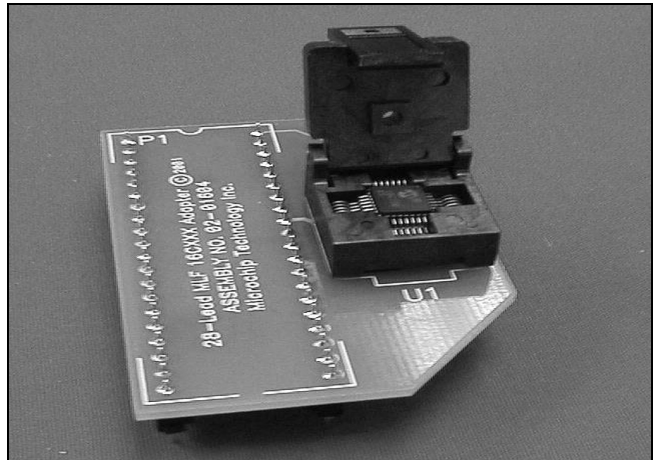

84-Pin PLCC Adapter Kit

PIC17C6X 84-Pin PLCC Adapter for PICSTART Plus.

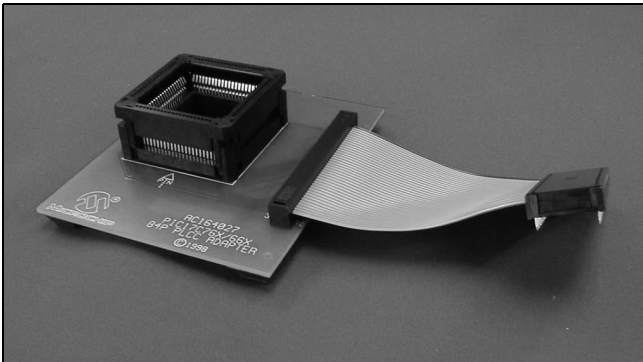

Ordering Part Number:

AC164024	68-Pin PLCC Adapter Kit
AC164027	84-Pin PLCC Adapter Kit
AC164031	28-Pin QFN Adapter Kit for 40-Pin ZIF Socket
AC164032	8-Pin DFN Adapter Kit
AC164033	28-Pin QFN Adapter Kit for 18-Pin ZIF Socket
AC164034	44-Pin QFN Adapter Kit

Key to Kit Contents



Enclosed Development Tool



Electronic Board



Samples



CD



Hook-up Cable(s)



Power Supply



Printed Documentation



World Wide Web

July 2003

IN-CIRCUIT DEBUGGER

Development Tools Ordering Guide

NOTES:



MPLAB® ICD 2 In-Circuit Debugger



The MPLAB ICD 2 module is a low cost development tool that connects between the PC and the designers target board allowing direct in-circuit debugging of

a PICmicro® target microcontroller. Programs can be executed in real time or single step, watch variables established, break points set, memory read/writes accomplished and more. It can also be used as a development programmer for the microcontrollers.

The MPLAB ICD 2 allows debugging of selected FLASH-based Microchip microcontrollers using MPLAB Integrated Development Environment (IDE). This powerful graphical user interface is included with each unit as a free tool. It is the ideal tool for embedded controller designers who do not have the budget for a high-cost in-circuit emulator.

Shared overhead is: one stack level, some general purpose file registers and a small bank of program memory when in the debug mode and two hardware pins (RB6 and RB7) lines.

The MPLAB ICD 2 is firmware-based, which allows it to be enhanced to support future microcontroller products and new features extending the tool life and making it a valued buy. Firmware downloads are available from the Microchip web site at: www.microchip.com.

Features

- USB (Full Speed 2 Mbits/s) and RS-232 interface to Host PC
- Real time background debugging
- Built-in over voltage/short circuit monitor
- Supports low voltage operation to 2.0 volts
- Diagnostic LED's (Power, Busy, Error)
- Reading/Writing memory space and stack of target microcontroller
- Erase of program memory space with verification
- Freeze on Halt

Ordering Part Number:

DV164005	MPLAB ICD 2 Module (Includes MPLAB ICD 2 Module and USB Cable)
DV164006	MPLAB ICD 2 Evaluation Kit (Includes MPLAB ICD 2 Module, USB Cable, RS-232 Cable, Power Supply and PICDEM™ 2 Plus Demonstration Board - DM163022)
DV164007	MPLAB ICD 2 Module ws (Includes MPLAB ICD 2 Module, USB Cable, RS-232 Cable and Power Supply)

MPLAB® ICD 2 Accessories

RS-232 and Power Supply Kit

Universal Power Supply and Serial Cable to support using the ICD 2 for serial communications or with the Universal Programmer Module. These items are included with the MPLAB ICD 2 DV164006 and DV164007 products.

Universal Programming Module

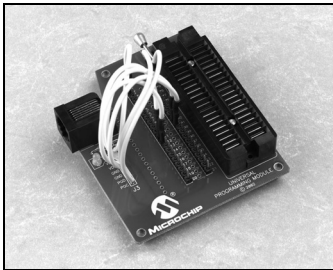

The Universal Programming Module is a handy low cost tool to support programming of DIP packaged products from Microchip.

It can be used in conjunction with the In-Circuit Debugger

(MPLAB ICD 2) to provide an easy means for programming microcontrollers.

Seven flying leads break out the primary programming lines needed for any microcontroller. These are connected to the 40 breakout pins of the ZIF socket, allowing any part to be configured to the necessary programming lines.

Features

- ZIF Socket
- Supports up to 40-pin devices from 300 to 600 mil width
- MPLAB ICD 2 Connector

MPLAB ICD 2 Header Interfaces

The header interface provides In-Circuit Debugging capability to the 8-pin, 14-pin or 18-pin device. The header interface is connected in place of the target device and houses a standard MPLAB ICD 2 connector. In-circuit debugging is done via an MPLAB ICD 2. Once the code is debugged, the debugged software can then be programmed into the device and installed in the board replacing the header.

MPLAB ICD Header Interface

A handy device that plugs into the existing 40-pin DIP socket on the development board where a FLASH based microcontroller would be. It breaks the connection to RB5, RB6 and RB7, which are then connected to the standard MPLAB ICD connector. This provides access for immediate in-circuit debugging without having accommodating hardware on your board.

Ordering Part Number:

AC162048	RS-232 and Power Supply Kit
AC162049	Universal Programming Module
AC162050	PIC12F629/675 MPLAB ICD 2 Header Interface Module
AC162051	MPLAB ICD Header Interface Module
AC162052	PIC16F630/676 MPLAB ICD 2 Header Interface Module (14-Pin DIP)
AC162053	PIC16F648A/627A/628A MPLAB ICD 2 Header Interface Module (18-Pin DIP)

July 2003

DEMO BOARDS AND EVALUATION KITS

Key to Kit Contents



Enclosed Development Tool



Electronic Board



Samples



CD



Hook-up Cable(s)



Power Supply



Printed Documentation



World Wide Web

Development Tools Ordering Guide

NOTES:



PICDEM™ Demonstration Boards

The PICDEM Demonstration boards, PICDEM 1, PICDEM 3, PICDEM 14A and PICDEM 17 are simple boards which demonstrate the capabilities of Microchip PICmicro® MCU families. See *Development Tools Cross Reference*, page 77, for specific device support for each board.

All necessary hardware is included to run basic demonstration programs, which are supplied on a 3.5-inch disk or CD. The users can program the samples provided with the PICDEM on a PRO MATE® II or PICSTART® Plus Programmer and easily debug/test the sample code, or the user can connect the PICDEM to the MPLAB® ICE and download the sample code to the emulator and debug/test the code. Additionally, a generous prototype area is available for user hardware.

PICDEM Demonstration Board Contents

- PICDEM Demonstration Board (1, 3, 14A or 17 as applicable)
- Product Samples
- Demo/Tutorial Software (PICDEM 3 is written in C using the MPLAB C/demonstration version)
- Complete Documentation

Ordering Part Number:

DM163001	PICDEM 1 Demonstration Board
DM163003	PICDEM 3 Demonstration Board
DM143001	PICDEM 14A Demonstration Board
DM173001	PICDEM 17 Demonstration Board

Development Tools Ordering Guide

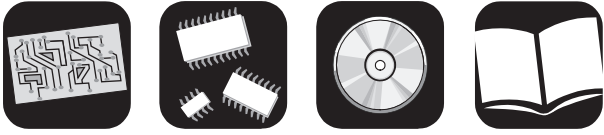

PICDEM™ 2 Plus Demonstration Board

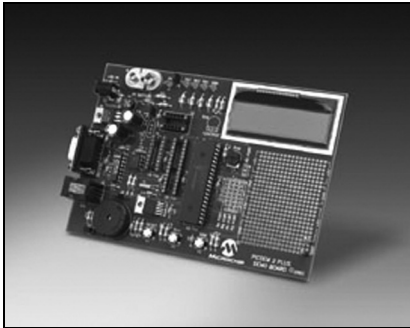

The PICDEM 2 Plus is a powerful, low cost learning and demonstration board. The board comes with an active program loaded on the installed PIC18F452 microcontroller

that provides real time clock and local temperature display. The code to accomplish all these program features is provided unassembled so the user can understand and dissect the programming algorithm helping them to quickly learn. The user can then take advantage of the FLASH- based microcontroller and its in-circuit debugger capability by cutting, pasting, rewriting or adding to the program to make their own modification (a ICD is required to do this). All of the microcontroller port pins are terminated at a connector header and there is space provided in the generous prototyping area for project development work.

Features

- 2 x 16 LCD Display
- Piezo Sounder Driven by PWM Signal
- Active RS-232 Port
- On Board Temperature Sensor
- Sample PIC16F877 and PIC18F452 FLASH Microcontrollers
- ICD Connector
- Generous Prototyping Area

PICDEM 2 Plus Demonstration Board Contents

- PICDEM 2 Plus Demonstration Board
- PIC16F877 and PIC18F452 Product Samples
- Documentation

Ordering Part Number:

DM163022 PICDEM 2 Plus Demonstration Board

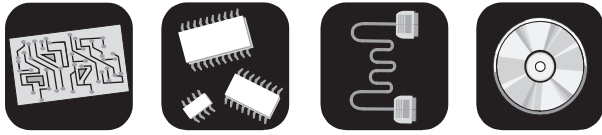

PICDEM™ 4 Demonstration Board

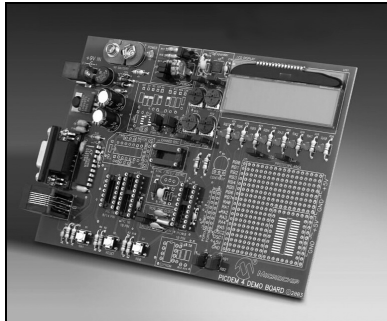

The PICDEM 4 Demonstration Board supports Microchip's low pin-count PICmicro® FLASH microcontrollers, including the PIC16F and PIC18F families featuring nanoWatt Technology. NanoWatt

Technology refers to Microchip's advanced PMOS Electrically Erasable Cell (PEEC) process technology, circuit design, manufacturing and application techniques.

The PICDEM 4 Demonstration Board can be used to evaluate and demonstrate the capabilities of Microchip's 8-, 14- and 18-pin PIC12F, PIC16F and PIC18F microcontrollers. The demonstration board showcases many features of low pin-count parts, including Local Interconnect Network (LIN) and motor control features using the enhanced capture/compare/PWM module (ECCP). Low-power operation is achieved with a supercapacitor circuit and jumpers allow the on-board hardware to be disabled to eliminate current draw in this mode.

Tutorial firmware and samples of a PIC16F and PIC18F FLASH microcontroller are included to assist the user in becoming familiar with the PICDEM 4 Demonstration Board and to demonstrate the unique features of the supported devices.

By connecting the PICDEM 4 Demonstration Board to the MPLAB® ICD 2, a designer can develop, simulate, debug and download code to the microcontroller using Microchip's powerful graphical MPLAB Interactive Development Environment (IDE). MPLAB IDE is a seamless, integrated software development environment that includes a MPASM™ macro assembler, MPLAB SIM software simulator with symbolic debugger, color-coded source editor, project manager with high-level language

debugging and concurrent support for development tools, including low-cost in-circuit debuggers, full-featured real-time emulators and programmers. The consistent and easy-to-use graphic user interface of the MPLAB desktop allows for rapid switching between development, debugging and programming modes within a project. The MPLAB ICD 2 (DV164007) is available separately. Microchip's MPLAB IDE software can be downloaded free of charge from the Microchip web site.

Features

- RS-232 interface.
- 2 x 16 liquid crystal display
- In-circuit debugger (ICD) connector for programming via In-Circuit Serial Programming™ (ICSP™) technology or developing with the MPLAB ICD 2
- Eight (8) LEDs, four (4) potentiometers, three (3) push buttons
- PCB footprints for an EEPROM, H-Bridge motor driver and LIN transceiver
- Support for crystal, RC or canned oscillator modes.
- Support for either 9-volt power adapter or battery, or hooks for a 5-volt, 100 mA regulated DC supply
- Generous prototyping area and header for expansion.

PICDEM 4 Demonstration Board Contents

- PICDEM 4 Demonstration Board
- Serial Cable
- PICmicro FLASH Microcontroller Samples
- Sample Programs, Application Notes and User's Guide on CD

Ordering Part Number:

DM163014 PICDEM 4 Demonstration Board

Development Tools Ordering Guide



PICDEM™ 18R Demonstration Kit

This kit demonstrates the power and flexibility of our new ROMless PIC18C601/801 microcontrollers and will significantly speed up development time for integrating these parts into an end product. The ROMless demonstration board will allow several alternative types of memory to be evaluated with PICmicro® MCUs. It includes an ICD connector interface for the MPLAB® ICD 2 In-Circuit Debugging Module, which allows low cost debugging.

Features

- Support for 68-pin PLCC PIC18C601 and 84-pin PLCC PIC18C801 Devices
- 8-bit Multiplexed (PIC18C601) and De-multiplexed (PIC18C801) Memory Interfaces
- 16-bit Word Select Mode and Byte Select Mode Memory Interfaces
- 2 MB x 8, 1 MB x 16 JEDEC Compliant FLASH Memory

- 128 KB x 8 SRAM, 64 KB x 16 JEDEC Compliant SRAM Memory Support for PC Downloadable Executable Code into SRAM
- Start Execution on-the-fly, General Purpose, User Configurable, PC Downloadable External Memory Programmer Host Software
- Eight Memory-mapped LED Outputs
- Two Push-button Switches
- One Analog Potentiometer Input; 64KB I²C™ EEPROM and a 4-bit LCD Connector

PICDEM 18R Demonstration Kit Contents

- PICDEM 18R Demonstration Board
- Product Samples
- CD
- Serial Cable
- Power Supply
- Documentation

Ordering Part Number:

DM163006 PICDEM 18R Demonstration Kit



PIC18F2539 Motor Control Evaluation Kit

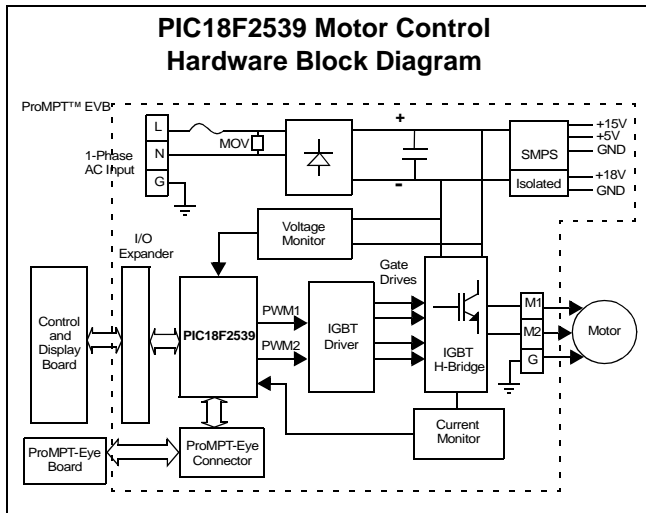

Microchip Technology Inc. and Anacon Systems, Inc. have jointly developed a motor control evaluation kit used to demonstrate the PIC18F2539 motor control microcontroller. The PIC18F2539 Motor Control Evaluation Kit (PIC18F2539 MC Eval Kit) provides great flexibility for the user to develop applications that work directly with the motor control kernel that resides in the PIC18F2539. The kit uses Programmable Motor Control Processor Technology (ProMPT™). The ProMPT board is a compact module containing proprietary circuits and a sophisticated firmware kernel required for single phase induction motor control. The motor control is based on open loop variable voltage and variable frequency (VF) technology.

Most of the I/O pins are brought out to the I/O expander connector on the ProMPT EVB board. This enables the user to develop hardware required for the application.

The DashDriveMP™ software is the Graphical User Interface (GUI) that allows the user to configure the drive parameters with ease and flexibility. The ProMPT EVB with the ProMPT-Eye board, communicates with the DashDriveMP software over the wireless media on infrared. The ProMPT EVB includes default motor parameters and VF curves. The user can command a frequency using the graphical interface and see the status on the ProMPT EVB, such as motor current, bus voltage and heat sink temperature. The user can also modify the parameters, including the acceleration rate, deceleration rate and the VF curve using the DashDriveMP GUI.

PIC18F2539 Motor Control Evaluation Kit Contents

- ProMPT Evaluation Board (EVB) with heat sink (Single phase induction motor control board)
- ProMPT-Eye board
- Control and display board
- Motor Control Evaluation Configuration CD:
 - DashDriveMP™ V1.0 for Windows® 98, Windows® ME, Windows® 2000 and Windows® XP
 - DashDriveMP User's Guide
 - PIC18F2539 Motor Control Evaluation Kit User's Guide
 - Demo programs
- Input power cable
- Shaded pole induction motor
- Documentation

Ordering Part Number:

DM183010 PIC18F2539 Motor Control Evaluation Kit

Development Tools Ordering Guide



PIC18FXX20 64/80L TQFP Demonstration Board

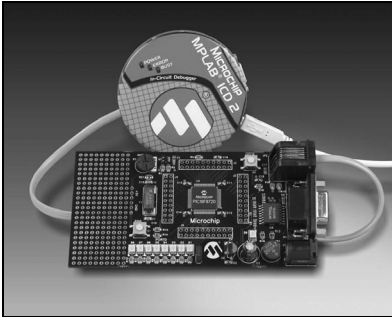

The low-cost PIC18FXX20 64/80L TQFP Demonstration Board is designed for evaluation of Microchip's high pin-count PIC18F FLASH microcontrollers. Fully functional right

out of the box, the tool demonstrates the digital and analog peripherals of the PIC18FXX20 MCUs and allows for rapid and easy prototyping without the need to design a printed circuit board to support the included PIC18F8720 FLASH microcontroller.

The PIC18FXX20 demonstration board offers digital features that include an RS-232 Serial Port, ICD connection, 8 x LED for diagnostic tests, crystal clock circuit (RC option) and reset and user buttons. Analog features include potentiometer input to an analog-to-digital converter (ADC) input channel and a sample of Microchip's TC74 temperature sensor. Outfitted with a PIC18F8720 FLASH microcontroller, the demonstration board also complements Microchip's MPLAB[®] In-Circuit Debugger (ICD) 2 tool. The MPLAB ICD 2 (shown in photo) is available separately.

Features

- PIC18F8720 – 80-pin TQFP unit mounted
- 5V regulated power supply circuit
- Clock circuit (20 MHz Crystal, RC option available)
- RS-232 Connection
- ICD Connector
- Pin break-out for easy probe access and prototyping
- 8 LED (with Disconnect Jumper)
- RB0 Push Button (for Bootloader Operation)
- Potentiometer (ADC Demo)
- Temperature Sensor Demo (Microchip TC74 Part)
- Reset Circuit with Push Button

PIC18FXX20 64/80L TQFP Demonstration Board Contents
<ul style="list-style-type: none">• PIC18FXX20 64/80L TQFP Demonstration Board• Serial Cable

Ordering Part Number: DM183020 PIC18FXX20 64/80L TQFP Demonstration Board
--



PICDEM™ USB Demonstration Kit

PICDEM USB from Microchip demonstrates a PICmicro® microcontroller (PIC16C765) communicating to a PC using the USB port.

A traditional mouse, keyboard or joystick can be connected to the USB port on a computer using the preprogrammed board supplied in the kit.

Features

- Status LED's
- Out of the Box Working Demo
- Generous Prototyping Area
- PS-Port
- Gameport

PICDEM USB Demonstration Kit Contents

- PICDEM USB Demonstration Board with Large Prototype Area
- USB, Serial, PS-2 and Gameport Connectors
- USB Support Firmware and Example Code
- Documentation

Ordering Part Number:

DM163010 PICDEM USB Demonstration Kit

Development Tools Ordering Guide



PICDEM™ CAN-LIN 1 and CAN-LIN 2 Demonstration Boards

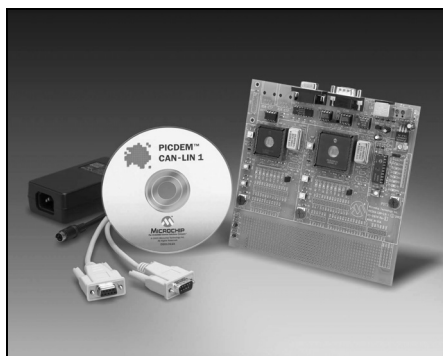

The PICDEM CAN-LIN 1 and CAN-LIN 2 demonstration boards demonstrate the main features of the PIC18C658 and PIC18C858, or PIC18F258 and PIC18F458

respectively, including those features of the integrated CAN module. In addition to the CAN network the board also employs a LIN sub-network using Microchip's PIC16C43X device family.

The PICDEM CAN-LIN 1 or CAN-LIN 2 kit includes both firmware and PC software for simulating a CAN network. The firmware comes pre-programmed on the sample device. The PC software and documentation are furnished on a CD.

PICDEM CAN-LIN 1 Features

- 68-pin PLCC PIC18C658 and 84-pin PLCC PIC18C858 devices
- 20-pin TSSOP PIC16C432 PIC® + LIN Bus transceiver

PICDEM CAN-LIN 2 Features

- 28-pin SDIP PIC18F258 and 40-pin PDIP PIC18F458 devices
- 20-pin TSSOP PIC16C432 PIC + LIN Bus transceiver

Features

(Common to CAN-LIN 1 and CAN-LIN 2)

- On-board digital and analog +5V regulator for direct input from 12V AC/DC wall adapter
- Two on-board CAN nodes and optional external CAN bus connectors
- On-board LIN Bus master and slave node, optional external LIN Bus connector
- DB-9 RS-232 interface to IBM compatible PC
- Total of two optional ICSP™ connectors – one for each PIC18C658/858 MCU
- Compatible with future PIC18C658/858 PLCC parts
- Optional header for LCD panel
- Other features similar to MCP2510 demo board

PICDEM CAN-LIN 1 and PICDEM CAN-LIN 2 Demonstration Board Contents

- PICDEM CAN-LIN 1 or PICDEM CAN-LIN 2 Demonstration Board
- Serial Cable
- Sample Programs, Application Notes and User's Guide on CD

Ordering Part Number:

DM163007	PICDEM CAN-LIN 1 Demonstration Board
DM163011	PICDEM CAN-LIN 2 Demonstration Board

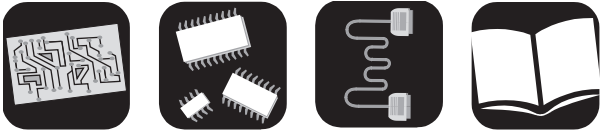

PICDEM™ LIN Demonstration Kit

The PICDEM LIN board demonstrates the capabilities of several Microchip microcontrollers using the LIN bus protocol. It supports slave node applications with PIC16C432, PIC16C433, PIC16C7XX and master node applications with PIC16X8X and PIC18FXX8. PIC16C432, PIC16C433 have on board LIN transceivers according to LIN bus specification V1.2.

This kit can be used to develop LIN hardware and software modules; demonstrate the LIN protocol in simple distribution network; evaluate the PIC16C432 LIN transceiver device; and quickly learn LIN bus interface. Integrate/interface LIN bus into product for proof-of-concept demonstration.

Features

- 18-, 28- and 40-pin DIP Sockets (Although three sockets are provided, only one device may be used at a time.)
- On-board +12V Regulator for Direct Input from 12V
- RS-232C Socket and Associated Hardware for Direct Connection to RS-232C Interface

- CAN Bus Interface
- Control Panel Interface for LIN Bus Master
- RF Stage for Keyless Entry Function
- Seat Memory Unit
- Motor Control Slave Unit

PICDEM LIN Demonstration Kit Contents

- PICDEM LIN Demonstration Boards (2)
- PIC16F874 – used as master in the LIN communication
- PIC16C432, PIC16C433 – used as slaves in LIN communication. Both have on board LIN transceiver
- Serial Cable
- *PICDEM LIN Demonstration Board User's Guide*

Ordering Part Number:

DM163005 PICDEM LIN Demonstration Kit

Development Tools Ordering Guide



PICDEM.net™ Demonstration/Evaluation Board

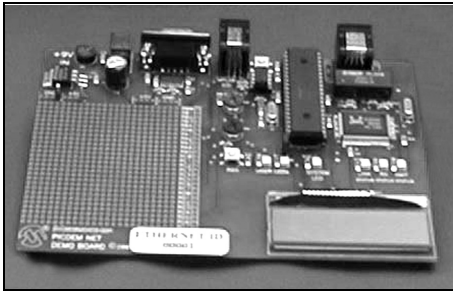

The PICDEM.net demonstration board is an Internet/Ethernet demonstration board using the PIC16F877

microcontroller and TCP/IP firmware. It connects the PICmicro® MCU to the local area network (LAN). It is a complete kit that is easy to use (a PC is required for set up). Interconnect to a network can be accomplished in less than one hour.

The board conforms to the standard 40-pin pinout used by the PIC16F877 or PIC18F452. The firmware used for the network interface was developed by Jeremy Bentham of Iosoft Ltd. based on his book *TCP/IP Lean: Web Servers for Embedded Systems* (ISBN: 1-929629-11-7).

The PICDEM.net board is also equipped with a 6-pin modular connector to interface directly with the Microchip MPLAB ICD 2 In-Circuit Debugger. With the addition of the MPLAB ICD 2 (sold separately), the developer can modify the on-board PICmicro microcontroller to meet the specific needs.

A generous breadboarding area is also available for experimental circuits or to add an embedded modem for dial-up capability if desired. It includes several status indicators including a 16 x 2 LCD indicator.

PICDEM.net Demonstration/Evaluation Board Contents

- PICDEM.net Demonstration Board with Firmware and PIC18F452 Microcontroller
- CAT 5 Ethernet Cable
- DB9 Serial Cable
- Universal Power Supply
- Software Demo and PICDEM.net User's Guide on CD
- Text Book – *TCP/IP Lean: Web Servers for Embedded Systems*

Ordering Part Number:

DM163004 PICDEM.net Demonstration/Evaluation Board



MCP2510 CAN Developer's Kit

The MCP2510 CAN Developer's Kit is a multifunction tool that speeds implementation of the MCP2510 stand-alone CAN controller by offering functions for controlling its feature-set.

In addition, this tool can be used to demonstrate basic CAN input/output functionality and monitor bus activity on the user's CAN bus. It is ideal for new CAN user's that want to understand how CAN may be used for network communication.

MCP2510 CAN Developer's Kit Contents

- MCP2510 Target Board
- User Interface Software (runs under Windows® 95/98)
- PC Parallel Port Interface Cable
- Power Supply
- Documentation including *MCP2510 CAN Developer's Kit User's Guide*

Ordering Part Number:

DV251001 MCP2510 CAN Developer's Kit

Development Tools Ordering Guide



MCP250XX CAN I/O Expander Developer's Kit

The MCP250XX CAN I/O Expander Developer's Kit includes everything needed to create a CAN-based system using Microchip's CAN I/O Expander family. It can be used to evaluate, demonstrate and develop CAN nodes using these CAN I/O Expanders. The demonstration mode has an MCP25050 that is configured prior to shipping and is programmed to manipulate analog inputs via potentiometers, PWM outputs via a piezoelectric buzzer and an incandescent lamp, and digital inputs via push-button switches. CAN messages can be sent and received between the master node and the demonstration node via the PC-user interface or via the input/output functionality discussed above. Users can also set up a watch window to display the message traffic as they manipulate the inputs and outputs. In this manner, the users can see a working network being demonstrated with one of the nodes being an MCP25050 CAN I/O Expander device.

Another function of the developer's kit is that the PC, with included software, can be used to emulate an MCP250XX device. This mode is used to manipulate the registers of the MCP250XX devices in order to evaluate all of the different functionality and configurations of the device family. After users are comfortable with a configuration, they can then prototype their own CAN node. An unconfigured MCP250XX device is supplied with prototyping area also included on the target board. A header is provided to enable oscilloscope access to the I/O pins for development and troubleshooting. Once prototyping is complete, the kit can be used to program up the device configuration in much the same manner that Microchip PICmicro® MCUs are programmed.

Features

- Speeds Understanding of CAN I/O Expander Family
- Provides Ability to Prototype User-defined CAN Node
- Enables Programming of Device Default Configuration Directly from Developer's Kit
- Allows Connection of External CAN Networks
- Software Watch Window can be used as a Basic CAN Bus Monitor

MCP250XX CAN I/O Expander Developer's Kit Contents

- Target Board with Three CAN Nodes Connected via a CAN Bus
- MCP250XX Product Samples
- PC Software to Interface to the Target Board
- PC Parallel Port Interface Cable
- Power Supply
- Complete Documentation

Ordering Part Number:

DV250501 MCP250XX CAN I/O Expander Developer's Kit



MCP2120/2150 Infrared Developer's Kit

The MCP2120/2150 Infrared Developer's Kit includes everything needed to create a system that communicates using infrared wireless communication. It educates the designer on the IR communications technology and IrDA[®] protocol and can then be used to integrate these technologies into the designers product allowing proof of concept.

The kit includes Microchip's revolutionary MCP2150 Infrared Communications Controller supporting the IrDA Standard. It can be set up to communicate with other IrDA devices like PDA's and mobile phones as well. Host Interface can be selected as a UART (DB-9) to a PC using Hyperlink or as a Master controller/ASIC to the header. The boards also offer two types of transceivers: the component version (which is lower cost but complicated) or the integrated version (which is simple but higher cost). The kit demonstrates two PC's communicating with each other via IR.

MCP2120/2150 Infrared Developer's Kit Contents

- Two MCP2120 IR Nodes
- One MCP2150 IR Node
- Product Samples
- Serial Cables
- Universal Power Supply
- Documentation

Ordering Part Number:

DM163008 Infrared Developer's Kit

Development Tools Ordering Guide



PICDEM™ MSC1 Demonstration Kit

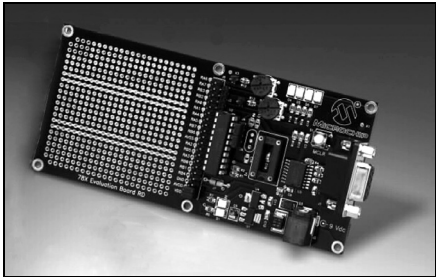

The PICDEM MSC1 with its PC-based Graphical User Interface (GUI) software serves as a demonstration board for the PIC16C781/782

microcontrollers. The user can configure the PIC16C781/782 from the easy to use PC software and download it to the microcontroller to evaluate the various peripherals and interconnect configurations. The GUI gives instant access to the PIC16C781/782 peripherals allowing on-the-fly configuration changes by means of an RS-232 link between the PC and evaluation board.

Initialization assembly code corresponding to the selected configuration can be built using the supplied Code Generator. Developers can use the Code Generation to perform an entire configuration using the Evaluation Tool and save it as a disk file.

Features

- Demonstrate all the PIC16C781/782 Peripherals
- Large Breadboard Area
- Easy to use PC-based GUI for:
 - Configuration of peripheral blocks
 - Download configuration to hardware
 - Save configuration setup and import into MPLAB® IDE

PICDEM MSC1 Demonstration Kit Contents

- PICDEM MSC1 Demonstration Board
- Jumper Wires
- Serial Cable
- CD with GUI Interface Program

Ordering Part Number:

DM163012 PICDEM MSC1 Demonstration Kit



PICDEM™ MSC1 Daughter Boards

The following daughter boards, available separately, demonstrate additional capabilities of the PIC16C781/782 microcontrollers.

PICDEM™ MSC1 Switch Mode Power Supply (SMPS) Daughter Board

The PICDEM™ MSC1 Switch Mode Power Supply (SMPS) Daughter Board, in combination with the PICDEM MSC1 Demonstration Board is a complete demonstration and evaluation kit for designing switch mode power supplies using the PIC16C781/782. The Daughter Board can be configured for the following switch mode power supply topologies:

- Boost: Output voltage greater than the supply voltage
- Buck: Output voltage less than the supply voltage
- Buck-Boost: Output voltage less than or greater than the supply voltage
- Invert: Negative output voltages

PICDEM™ MSC1 Infrared (IR) Driver Daughter Board

The PICDEM™ MSC1 Infrared (IR) Driver Daughter Board, in combination with the PICDEM MSC1 Demonstration Board serves as a demonstration and evaluation kit for designing a high power IR remote control transmitter using the PIC16C782. The Daughter Board, in combination with the included IR receiver, implements both receive and transmit sections of a Pulse Width Modulation (PWM) IR remote control system.

PICDEM™ MSC1 Delta-Sigma ADC Daughter Board

The PICDEM™ MSC1 Delta-Sigma ADC Daughter Board, in combination with the PICDEM MSC1 Demonstration Board, serves as a demonstration and evaluation kit for designing high resolution Delta Sigma Analog-to-Digital Converters using the PIC16C781/782. The Daughter Board has the following features:

- All the components required to implement an 8 to 16-bit Delta-Sigma ADC
- An RCA connector for connecting an external sensor
- A generous prototyping area for building signal-conditioning circuitry
- An on-board temperature sensor for a demonstration input to the ADC

PICDEM™ MSC1 Flow Rate Sensor Daughter Board

The PICDEM™ MSC1 Flow Rate Sensor Daughter Board, in combination with the PICDEM MSC1 Demonstration Board is a complete demonstration kit for a high sensitivity Hot-Wire anemometer-styled Flow Rate Sensor using the PIC16C782.

PICDEM MSC1 Daughter Board Contents

- PICDEM MSC1 Daughter Board
- Complete Documentation

Ordering Part Number:

AC163001	PICDEM MSC1 Switch Mode Power Supply (SMPS) Daughter Board
AC163002	PICDEM MSC1 Infrared (IR) Driver Daughter Board
AC163003	PICDEM MSC1 Delta-Sigma ADC Daughter Board
AC163004	PICDEM MSC1 Flow Rate Sensor Daughter Board

Development Tools Ordering Guide



MCP41XXX/42XXX Digital Potentiometer Evaluation Board

The MCP41XXX/42XXX Evaluation Board is a demonstration and evaluation tool for Microchip Technology's MCP41XXX/42XXX digital potentiometers. The MCP41XXX/42XXX Evaluation Board is designed to be used in conjunction with the MXDEV[®] Driver Board. When connected to the driver board with the included microcontroller installed, this evaluation board allows for the programming and evaluation of the MCP41XXX/42XXX digital potentiometer in a variety of applications.

Some of the applications that can be used for evaluation of the MCP41XXX/42XXX digital potentiometers include an offset circuit, low-pass filter, and gain circuits. A removable prototype area is available for quick-turn circuit evaluation. Evaluation of other operations such as daisy chain, shutdown and reset are also available. Software tools for the digital potentiometer and ADC are also provided for evaluation.

MCP41XXX/42XXX Digital Potentiometer Evaluation Board Contents

- MCP41XXX/42XXX Evaluation Board
- Removable Prototype Board
- MCP41XXX/42XXX Samples and Reprogrammable Microchip FLASH PICmicro[®] MCU
- MXLAB[®] ADC Software
- RS-232 Cable
- 9V DC Power Supply
- Documentation, including the *MCP42XXX Evaluation Board User's Guide*

Ordering Part Number:

DV42XXX MCP41XXX/42XXX Evaluation Board



MXDEV[®] 1 Analog Evaluation System Driver Board

The MXDEV 1 Analog Evaluation System gives system designers the ability to control Microchip stand-alone analog devices, acquire data and then analyze the data using stripcharts, histograms and Fast Fourier Transforms (FFTs). User-friendly data analysis software is included with the device-specific Daughter Boards.

The evaluation system consists of two parts: a Driver Board, which performs the data analysis and connects to a PC for subsequent analysis and display; and a Daughter Board, which plugs into the Driver Board and contains the device to be evaluated. Device-specific software is included.

In addition to the ability of the Driver Board to work with device-specific Daughter Boards, users can create their own Daughter Boards based on their own design requirements. In addition, a prototype area on the Driver Board is available for user-designed circuits that could be used in place of the Daughter Boards.

The MXDEV 1 Analog Evaluation System Driver Board contains three different PICmicro[®] microcontroller sockets (28-pin, 18-pin and 8-pin) so that users can choose the PICmicro MCU most suited to their application. It also includes an LCD display, an LED display socket, SRAM for data storage, and an RS-232 interface. The LCD display can display information such as configuration data and acquisition data from the Daughter Board.

The Daughter Board kits contain the device to be evaluated and a PIC16F876 FLASH microcontroller containing device-specific code. The microcontroller then plugs into one of the sockets on the DVMCPA. Code is also provided that shows how to interface the PIC16C54 and the PIC12C509 with the ADC.

MXDEV 1 Analog Evaluation System Driver Board Kit Contents

- Driver Board
- Microcontroller Samples
- RS-232 Cable
- MXLAB[®] ADC Software
- Two Power Supplies
- Documentation, including the *Analog Driver Board User's Guide*

Ordering Part Number:

DVMCPA MXDEV 1 Analog Evaluation System Driver Board

Development Tools Ordering Guide



MXDEV[®] 1 MCP3XXX Single/Dual ADC Evaluation System Daughter Board Kit

The MXDEV 1 MCP3XXX Single/Dual ADC Evaluation System Daughter Board Kit supports the following devices: MCP3001, MCP3002, MCP3201, MCP3202 and MCP3301.

This kit includes jumper-selectable options for maximum flexibility. Choices include:

- Selection of the signal source between the on-board potentiometer and an external source.
- Selection of the ADC reference voltage between the on-board VREF and an external source.
- Selection between single-ended and pseudo-differential inputs (depending on the device being evaluated).

There is a prototype area on the board for additional circuitry as needed.

MXDEV 1 MCP3XXX Single/Dual ADC Evaluation System Daughter Board Kit Contents

- MXDEV 1 MCP3XXX Single/Dual ADC Daughter Board
- Filter Boards
- Samples for All Supported A/D Converts and Pre-programmed PICmicro[®] MCU for Use in the Driver Board
- Adapter Plugs
- MXLAB[®] ADC Software
- Documentation, including the *MCP3XXX Daughter Board User's Guide*

Ordering Part Number:

DV3201A MXDEV 1 MCP3XXX Single/Dual ADC Evaluation System Daughter Board



MXDEV[®] 1 MCP3XXX Quad/Octal ADC Evaluation System Daughter Board Kit

The MXDEV 1 MCP3XXX Quad/Octal ADC Evaluation System Daughter Board Kit supports the following devices: MCP3004, MCP3008, MCP3204, MCP3208, MCP3302 and MCP3304.

This kit includes jumper-selectable options for maximum flexibility. Choices include:

- Selection of the signal source between the on-board potentiometer and an external source.
- Selection of the ADC reference voltage between the on-board VREF and an external source.
- Selection between single-ended and pseudo-differential inputs (depending on the device being evaluated).

There is a prototype area on the board for additional circuitry as needed.

MXDEV 1 MCP3XXX Quad/Octal Evaluation System Daughter Board Kit Contents

- MCP3XXX Quad/Octal Daughter Board
- Filter Boards
- Samples for All Supported A/D Converts and Pre-programmed PICmicro[®] MCU for Use in the Driver Board
- Adapter Plugs
- MXLAB[®] ADC Software
- Documentation, including the *MCP3XXX Daughter Board User's Guide*

Ordering Part Number:

DV3204A MXDEV 1 MCP3XXX Quad/Octal Evaluation System Daughter Board

Development Tools Ordering Guide



TC642EV – Evaluation Kit for Brushless DC Fan Controllers

The TC642EV is a complete evaluation board for evaluation and prototyping brushless DC fan control circuits using Microchip's TC642, TC646, TC647, TC648 and TC649 BDC fan controllers. The fan speed control signal can be provided by an external sensor or voltage signal, or from the on-board potentiometer. Minimum speed setting and auto shutdown threshold are conveniently set by a potentiometer. Jumper blocks allow the user to quickly configure the output stage and input signal source and scaling. Test points provide easy access for instrument readings at critical nodes. A user prototyping area is provided for dedicated circuitry or other user specific circuits.

Ordering Part Number:

TC642EV

TC642DEMO – Fan Controller Demo Board for TC642/646/647/648/649

This Fan Control Module allows the user to quickly prototype fan control circuits based on Microchip's PWM Fan Control IC's (TC642, TC646, TC647, TC648 or TC649). This 1.5" by 2.0" board's versatile sensor input and output driver circuitry allows the Fan Control Module to be used with virtually any brushless DC fan and standard thermistor. An optional LED status indicator gives a visual indication of a fan fault condition (open stator, blocked rotor or over temperature fault detection). It uses through hole components for easy user modification.

Ordering Part Number:

TC642DEMO

TC650DEMO – Fan Controller Demo Board for TC650/651

This 1.0" x 1.0" Fan Control Demo Board allows the user to quickly prototype fan control circuits based on Microchip's TC650 or TC651 PWM Fan Control IC's. The board can interface with virtually any brushless DC fan. A red LED status indicator gives visual indication of a fan fault condition (open stator or blocked rotor) and a green LED status indicator gives a visual indication of an over temperature alert (temperature is 10°C higher than the high temperature limit).

Ordering Part Number:

TC650DEMO

TC652DEMO – Fan Controller Demo Board for TC652/653

This 1.0" x 1.2" Fan Control Demo Board allows the user to quickly prototype fan control circuits based on Microchip's TC652 or TC653 PWM Fan Control IC's. The board can interface with virtually any brushless DC fan. A red LED status indicator gives visual indication of a fan fault condition (open stator or blocked rotor) and a green LED status indicator gives a visual indication of an over temperature alert (temperature is 10°C higher than the high temperature limit).

Ordering Part Number:

TC652DEMO

TC74DEMO – Serial Digital Temperature Sensor Demo Board

The TC74 Demo Board allows the user to evaluate the functionality of the tiny TC74 thermal sensor and perform comparative evaluation against other thermal management solutions. This 0.75" by 2.5" PC board is an ideal solution for identifying the temperature profile of applications like datacom, telecom and PC equipment. An easy-to-use software provides a visual representation of temperature profile and can interface with any PC.

Ordering Part Number:

TC74DEMO



dsPICDEM™ Starter Demonstration Board

The low-cost dsPIC® MCU Starter Demo Kit allows the user to easily validate a development tool setup using the dsPIC30F. It has a power supply regulator, crystal oscillator, ICD header, serial port, LEDs, push-buttons, potentiometer, and a prototyping area. In addition, all pins on the dsPIC device are brought out to a terminal block for access.

Features

- 5V power supply split at the regulator to provide a separate, de-coupled analog supply voltage useful in designs taking advantage of the 12-bit A/D converter.
- Analog peripherals including an MCP41010 digital potentiometer used as a DAC to generate signals, and a MCP6022 to provide output filtering for the DAC and an input filter for the 12-bit A/D. The filter cutoff frequencies are set to 4 KHz to allow telephone-quality signals.

The dsPICDEM starter board is delivered with a demo application that uses the digital potentiometer to generate audio tones. This output can be connected into the 12-bit ADC for measurement.

dsPICDEM Starter Demonstration Board Contents

- dsPICDEM Starter Demonstration Board
- Documentation on CD

Ordering Part Number:

DM300016 dsPICDEM Starter Demonstration Board

Estimated Availability: Q3 2003

Development Tools Ordering Guide



dsPICDEM™ 1.1 General Purpose Development Board

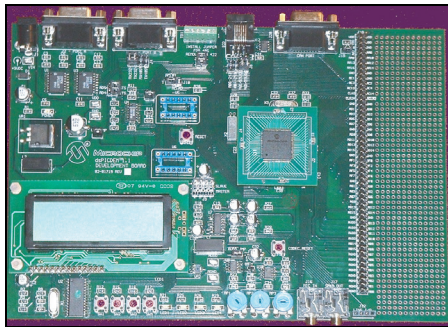

The dsPIC30F general purpose development board provides the application designer with a low cost development tool to become familiar with the

dsPIC30F 16-bit architecture, high performance peripherals and powerful instruction set.

The development board serves as an ideal prototyping tool in which to quickly develop and validate key design requirements.

Features

- dsPIC30F6014 MCU Based Board
- Serial Communication Channels Interface (two UARTS, SPI™, CAN, RS-485)
- Si3000 Codec with Line In/Out Jacks
- General Purpose Prototyping Area with Expansion Header
- 122 x 32 Dot Addressable LCD
- MPLAB® ICD 2 and MPLAB ICE 4000 Emulator support
- LED's, Switches and Potentiometers
- Temperature Sensor

dsPICDEM 1.1 General Purpose Development Board Contents

- dsPICDEM 1.1 Development Board with Pre-programmed dsPIC30F Device
- RS-232 Cable
- Power Supply
- Example Software and Documentation on CD

Ordering Part Number:

DM300014 dsPICDEM 1.1 General Purpose Development Board

Estimated Availability: Q3 2003



dsPICDEM™ MC1 Motor Control Development Board

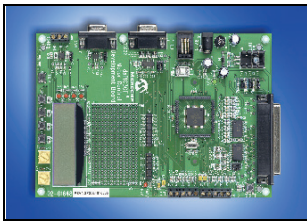

The motor control development board provides the application developer with three main components for quick prototyping and validation of BLDC, PMAC and ACIM applications. The three main components are: dsPIC30F Motor Control main board, 3-phase low voltage power module and 3-phase high voltage power module

The main control board contains the dsPIC30F6010 but supports all dsPIC® MCU motor control variances, various peripheral interfaces and a custom interface header system, which allows different motor power modules to be connected to the PCB. The control board also has connectors for mechanical position sensors, such as incremental rotary encoders and hall effect sensors, and a breadboard area for custom circuits. The main control board receives its power from a standard plug-in transformer.

The low voltage power module is optimized for 3-phase motor applications that require a DC bus voltage less than 50 volts and can deliver up to 400W power output. The 3-phase low voltage power module is intended to power BLDC and PMAC motors.

The high voltage power module is optimized for 3-phase motor applications that require DC bus voltages up to 400 volts and can deliver up to 1 kW power output. The high voltage module has an active power factor correction circuit that is controlled by the dsPIC30F device. This power module is intended for AC induction motor and power inverter applications that operate directly from the AC line voltage.

Features

- dsPIC30F6010 Motor Control MCU Based Board
- 3-phase Low Voltage Power Module (Optional)
- 3-phase High Voltage Power Module (Optional)
- Heatsink for Ambient Cooling of Power Sections
- Full Automatic Protection of Power Circuits
- Electrical Isolation from Power Circuits
- Many Options for Motor Feedback Signals

dsPICDEM MC1 Motor Control Development Board Contents

- dsPICDEM MC1 Motor Control Development Board with Pre-programmed dsPIC30F Device
- RS-232 Cable
- Power Supply
- Example Software and Documentation on CD

Ordering Part Number:

DM300020	dsPICDEM MC1 Motor Control Development Board
DM300021	dsPICDEM MC1H 3-Phase High Voltage Power Module
DM300022	dsPICDEM MC1L 3-Phase Low Voltage Power Module

Estimated Availability: Q3 2003

Development Tools Ordering Guide



dsPICDEM.net™ 1 and dsPICDEM.net™ 2 Connectivity Development Boards

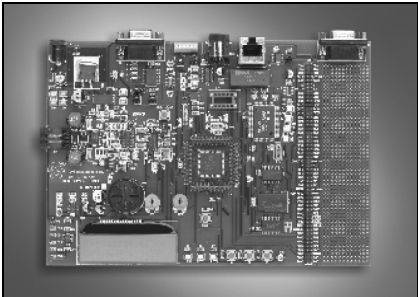

The dsPICDEM.net 1 and dsPICDEM.net 2 connectivity development boards provide the application developer a basic connectivity

platform for developing and evaluating various connectivity solutions, implementing TCP/IP protocol layers, combined with V.22/V.22bis and V.32 (non-trellis coding) ITU specifications across PSTN or Ethernet communication channels.

Features

- dsPIC30F6014 MCU based board
- Ethernet MAC and PHY interface
- PSTN interface with DAA/AFE chipset
- Serial Communication Channels Interface (UART and CAN)
- External I²C™ EEPROM memory for storing HTML pages
- External 64K x 16 SRAM Memory
- Prototyping area with expansion header
- 2x16 LCD display
- MPLAB ICD 2 and MPLAB ICE 4000 emulator support
- LED's, Switches and Potentiometers

dsPICDEM.net 1 and dsPICDEM.net2 Connectivity Development Board Contents
<ul style="list-style-type: none">• dsPICDEM.net Development Board with Pre-programmed dsPIC30F Device• RS-232 Cable• Power Supply• Example Connectivity Software and Documentation on CD

Ordering Part Number:
DM300004-1 dsPICDEM.net 1 Development Board (supporting FCC/JATE PSTN, Ethernet NIC)
DM300004-2 dsPICDEM.net 2 Development Board (supporting CTR-21 PSTN, Ethernet NIC)
<i>Estimated Availability: Q3 2003</i>



KEELOQ[®] Transponder Evaluation Kit

The KEELOQ Transponder Evaluation Kit hardware consists of a base station, a transmitter/transponder, a batteryless transponder and various transponder samples. The base station doubles as a programmer and decoder. The base station includes a coil used for generating a magnetic field used to communicate with a transponder inductively. The base station has an RF receiver for receiving KEELOQ code hopping transmissions.

The accompanying Windows[®] software is supplied on a CD and includes all the necessary software for programming and testing the transponder in all its modes.

KEELOQ Transponder Evaluation Kit Contents

- RF Receiver/Decoder Board
- HCSXXX Product Samples
- HCS410 Transmitter/Transponder
- HCS412 Passive Entry Transmitter/Transponder (2)
- HCS410 Batteryless Transponder
- KEELOQ License CD
- Interconnection Cable
- RS-232 Interface Cable
- Power Supply
- Complete Documentation

Ordering Part Number:

DM303005 KEELOQ Transponder Evaluation Kit

Development Tools Ordering Guide



KEELOQ® Evaluation Kit II

The KEELOQ Evaluation Kit II provides the opportunity to evaluate KEELOQ code hopping technology quickly and easily without having to make a large capital investment. The evaluation kit contains all the hardware and software necessary to implement a fully functional remote control system and demonstrate all operating modes of the following devices: HCS101, HCS200, HCS201, HCS300, HCS301, HCS320, HCS360, HCS361, HCS362, HCS365 and HCS370 encoders.

The kit can also be used to program and demonstrate the encoder functionality of the HCS410, HCS412 and HCS473 transponders (transcoders).

KEELOQ Evaluation Kit II Contents

- Programmer and Decoder Demonstration Board
- Two KEELOQ Transmitter Demo Boards
- Sample Kit Containing Various KEELOQ Encoder and Decoder Samples
- KEELOQ Secure Data Product CD

Ordering Part Number:

DM303006 KEELOQ Evaluation Kit II

Demo Boards and Evaluation Kits

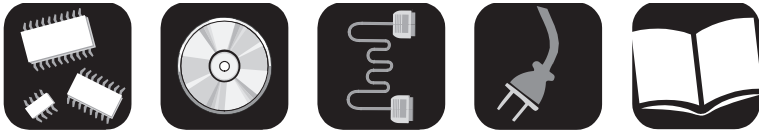

SEEVAL[®] 32 Serial EEPROM Designer's Kit

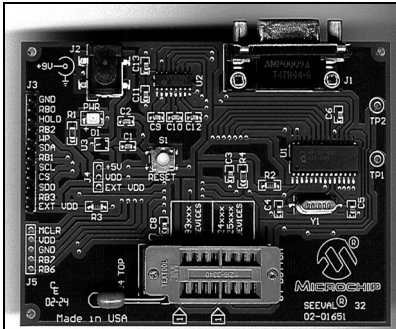

Microchip's SEEVAL 32 Serial EEPROM Evaluation and Programming System supports all Microchip Serial EEPROMs including future devices. Through the use of a ZIF

socket, standard DIP packages are directly supported; the 8-lead SOIC, TSSOP, MSOP, DFN and 5-lead SOT-23 packages can also be supported by using separate third-party adapters. Both the SEEVAL 32 and SEEVAL systems give the designer or system integrator the ability to read, write or erase any byte, page or the entire array, and to display, save or load this data as a file. Whereas the original SEEVAL system supports only Windows[®] 95/98 operating systems, the new SEEVAL 32 development system and its improved host software and firmware capabilities now provide support for all the current Windows[®] operating systems, including: Windows XP, Windows ME, Windows 2000, Windows NT[®] 4.0 and also Windows 95/98.

Both the SEEVAL and SEEVAL 32 systems provide advanced features to aid in system integration and debug. Through the use of test pins on each system an oscilloscope or other test equipment can be easily connected to evaluate timing and voltage levels. Through the SEEVAL host software, serial EEPROMs can be tested by reading and writing data in the EEPROM under test and by evaluating checksum data. Erase/Write Endurance can also be measured by selecting a continuous loop mode to repeatedly read/write/erase the EEPROM.

SEEVAL kits also include the Total Endurance Software Model, a powerful tool which can predict the erase/write endurance of any given serial EEPROM based upon its application parameters: temperature, voltage, cycles per day and bytes per cycle.

SEEVAL 32 Serial EEPROM Designer's Kit Contents

- Total Endurance Software Model
- SEEVAL 32 Evaluation and Programming System
- Serial EEPROM Sample Pack
- SEEVAL 32 Software
- RS-232 Interface Cable
- Power Supply

Ordering Part Number:

DV243002 SEEVAL 32 Serial EEPROM Development Kit

Estimated Availability: Q3 2003

Development Tools Ordering Guide



microID[®] Programmer Kits

The microID Contactless Programmer Kit is used to contactlessly program MCRF200, MCRF202 and MCRF250 microID devices. The programmer is calibrated for ISO-card tags, but can be adjusted to be used for virtually any 125 kHz microID tag design, including button tags and key fobs.

The microID Contact Programmer Kit is used to contact program MCRF355/360 devices.

microID Programmer Kit Contents
<ul style="list-style-type: none"> • Programmer • RF-LAB Software Interface (runs under Windows[®] 95/98, Windows 2000, Windows XP) • RS-232 Serial Cable • Power Supply • Documentation including a complete <i>System Design Guide</i> (Application Notes, Reference Designs, Firmware Listings and Tutorials)

microID Developer's and Programmer Kit* Selection Table						
Device Type	DV103001	DV103002	DV103003	DV103006	PG103001*	PG103003*
MCRF200	X				X	
MCRF202	X				X	
MCRF250		X			X	
MCRF355			X	X		X
MCRF360			X	X		X
MCRF45X				X		

*Programmer kits (PG) do not include RFID readers or product samples.

Ordering Part Number:	
PG103001	microID Contactless Programmer Kit for all 125 kHz devices – MCRF200/MCRF202/MCRF250 (This programmer is also included in the DV103001 and DV103002 Developer's Kits.)
PG103003	microID Contact Programmer Kit for MCRF355 and MCRF360 (This programmer is also included in the DV103003 and DV103006 Developer's Kits.)



125 kHz microID[®] Developer's Kit for MCRF200/202

The 125 kHz microID Developer's Kit is an easy-to-use tool for design engineers at all skill levels. This kit includes all the hardware, software, reference designs, and samples required to get started in 125 kHz RFID designs.

The developer's kit also includes a contactless programmer and three readers for three different configurations of MCRF200/202: 123h (ASK), 08Dh (PSK) and 00Ah (FSK).

The programmer is used to contactlessly program MCRF200/202 microID devices. The programmer is calibrated for ISO-card tags, but can be adjusted to be used for virtually any 125 kHz microID tag design, including button tags and key fobs.

MCRF200 samples are included in the kit, MCRF202 samples must be ordered separately.

125 kHz microID MCRF200/202 Developer's Kit Contents

- PSK Reader
- FSK Reader
- ASK Reader
- Contactless Programmer
- Samples in Card-Tag Form (123h, 08Dh, 00Ah)
- Samples in DIP Form (123h, 08Dh, 00Ah)
- RF-LAB 125 Software Interface (runs under Windows[®] 95/98, Windows 2000, Windows XP)
- Two RS-232 Cables
- Two Power Supplies
- Documentation including a complete *125 kHz System Design Guide* (Application Notes, Reference Designs and Tutorials)

Ordering Part Number:

DV103001 125 kHz Anticollision microID Developer's Kit for MCRF200 and MCRF202

Development Tools Ordering Guide



125 kHz Anticollision microID[®] Developer's Kit for MCRF250

The 125 kHz Anticollision microID Developer's Kit is an easy-to-use tool for design engineers at all skill levels. This kit includes all the hardware, software, reference designs, and samples required to get started in 125 kHz anticollision RFID designs.

The developer's kit includes a contactless programmer and anticollision reader for the most common configuration of MCRF250: 40Ah (FSK, NRZ, MOD50).

The programmer is used to contactlessly program the MCRF250 microID devices. The programmer is calibrated for ISO-card tags but can be adjusted to be used for virtually any 125 kHz microID tag design, including button tags and key fobs.

125 kHz microID MCRF250 Developer's Kit Contents

- FSK Anticollision Reader
- Contactless Programmer
- Samples in Card-Tag Form (40Ah)
- Samples in DIP Form (40Ah)
- RF-LAB 125 Software Interface (runs under Windows[®] 95/98, Windows 2000, Windows XP)
- Two RS-232 Cables
- Two Power Supplies
- Documentation including a complete *125 kHz System Design Guide* (Application Notes, Reference Designs and Tutorials)

Ordering Part Number:

DV103002 125 kHz Anticollision microID Developer's Kit for MCRF250



13.56 MHz Anticollision microID[®] Developer's Kit for MCRF355 and MCRF360

The 13.56 MHz microID Developer's Kit is an easy-to-use tool for design engineers at all skill levels. This kit includes all the hardware, software, reference designs, and samples required to get started in 13.56 MHz RFID designs.

This kit is intended to demonstrate basic operation of the high-performance MCRF355 tagging chip and basic design of a simple RFID reader.

microID MCRF355 and MCRF360 Developer's Kit Contents

- 13.56 MHz Anticollision Reader
- Contact Programmer
- Two Power Supplies
- Two RS-232 Cables
- RF-LAB 13.56 Software Interface (runs under Windows[®] 95/98, Windows 2000, Windows XP)
- Socketed Tags
- Flexible, Preprogrammed Performa[™] tags by Checkpoint Systems Inc.
- Samples in DIP Form
- Documentation including a complete *13.56 MHz System Design Guide* (Application Notes, Reference Designs and Tutorials)

Ordering Part Number:

DV103003 13.56 MHz Anticollision microID Developer's Kit for MCRF355 and MCRF360

Development Tools Ordering Guide



13.56 MHz Anticollision microID® Developer's Kit for MCRF355, MCRF360 and MCRF45X

The 13.56 MHz microID Developer's Kit is a high speed, long range, easy-to-use tool for design engineers at all skill levels. This kit includes all the hardware, software, reference designs, and samples required to get started in high performance 13.56 MHz RFID designs.

This kit is designed to demonstrate all 13.56 MHz RFID devices, including: MCRF355/360 and MCRF450/451/452/455 and to provide a basic platform for high-performance RFID reader design.

microID MCRF355, MCRF360 and MCRF45X Developer's Kit Contents

- 13.56 MHz Read/Write Interrogator
- Contact Programmer for MCRF355/360
- Two Power Supplies
- Two RS-232 Cables
- RF-LAB 13.56 Software Interface (runs under Windows® 95/98, Windows 2000, Windows XP)
- Socketed Tags
- Flexible, Preprogrammed Performa™ tags by Checkpoint Systems Inc.
- Samples in DIP Form
- Documentation including a complete *13.56 MHz System Design Guide* (Application Notes, Reference Designs and Tutorials)

Ordering Part Number:

DV103006 13.56 MHz Anticollision microID Developer's Kit for MCRF355, MCRF360 and MCRF45X



PowerSmart® Battery Manager Evaluation Kit for 3 or 4 Series Cell Lithium Ion/Polymer Chemistries

The PowerSmart Battery Manager Evaluation Kit for Lithium Ion/Polymer Chemistries provides the opportunity to evaluate a Microchip battery management solution for three or four series cell Lithium-based battery packs. The evaluation kit contains all of the hardware and software necessary to implement a functional SmartBattery pack with a primary and secondary safety circuit and a LED state-of-charge display. The kit can be used to configure and demonstrate functionality of the PS401 Battery Manager IC and the PS4160 Battery Manager Module.

PowerSmart Battery Manager Evaluation Kit for 3 or 4 Series Cell Lithium Ion/Polymer Chemistries Contents

- Battery Manager Module for 3 or 4 series cell Lithium Ion/Polymer Battery Packs
- PowerInfo Configuration Interface
- RS-232 Cable
- Power Supply
- PowerTool™ PC Software CD

Ordering Part Number:

PS4160EV-3	PowerSmart Battery Manager Evaluation Kit for Lithium Ion/Polymer Chemistries (3-cell)
PS4160EV-4	PowerSmart Battery Manager Evaluation Kit for Lithium Ion/Polymer Chemistries (4-cell)

Development Tools Ordering Guide



PowerSmart® Battery Manager Evaluation Kit for Nickel Chemistries

The PowerSmart Battery Manager Evaluation Kit for NiMH/NiCAD Chemistries provides the opportunity to evaluate a Microchip battery management solution for six to ten series cell Nickel-based battery packs. The evaluation kit contains all of the hardware and software necessary to implement a functional SmartBattery pack with a LED state-of-charge display. The kit can be used to configure and demonstrate functionality of the PS402 Battery Manager IC and the PS4200 Battery Manager Module.

PowerSmart Battery Manager Evaluation Kit for Nickel Chemistries Contents

- Battery Manager Module for 6-10 series cell NiMH/NiCAD Battery Packs
- PowerInfo Configuration Interface
- RS-232 Cable
- Power Supply
- PowerTool™ PC Software CD

Ordering Part Number:

PS4200EV PowerSmart Battery Manager Evaluation Kit for Nickel Chemistries

Estimated Availability: Q3 2003



PowerSmart® Battery Monitor Evaluation Kit for 1 and 2 Series Cell Lithium Ion/Polymer Chemistries

The PowerSmart Battery Monitor Evaluation Kit for Lithium Ion/Polymer Chemistries provides the opportunity to evaluate a Microchip battery monitor solution for one or two series cell Lithium-based battery packs. The evaluation kit contains all of the hardware and software necessary to incorporate a functional fuel gauge and safety module into a battery pack. The kit can be used to configure and demonstrate functionality of the PS700 Battery Monitor IC.

PowerSmart Battery Monitor Evaluation Kit for 1 and 2 Series Cell Lithium Ion/Polymer Chemistries Contents

- Battery Monitor Module for 1 and 2 series cell Lithium Ion/Polymer Battery Packs
- PowerInfo2 Configuration Interface
- USB Cable
- PowerMate™ PC Software CD

Ordering Part Number:

PS7050EV PowerSmart Battery Monitor Evaluation Kit for 1 and 2 Series Cell Lithium Ion/Polymer Chemistries

Estimated Availability: Q4 2003

Development Tools Ordering Guide

NOTES:



MICROCHIP

Development Systems Cross Reference

July 2003

CROSS REFERENCE

Please check the Microchip web site at: www.microchip.com for the latest Development Systems Cross Reference information presented in the Microchip Product Line Card (DS00148).

Development Tools Ordering Guide

NOTES:

Ordering Information

MPLAB® ICE 2000 and MPLAB® ICE 4000 Emulator Systems

How To Order MPLAB ICE

MPLAB ICE is easy to order, using these three steps.

1. Determine the PICmicro® MCU device needed.
2. Identify the PICmicro MCU package needed.
3. Locate the correct MPLAB ICE component part numbers from the following *Development Tools Cross Reference* pages.

A Complete MPLAB ICE System

MPLAB ICE is a modular emulator system with interchangeable components allowing the system to be easily configured to emulate different PICmicro MCUs. Since this emulator supports package-specific emulation, customers need to know which device and package they intend to emulate. The customer can then use the *Development Tools Cross Reference Parts List* on the following pages to identify the part numbers required to complete an MPLAB ICE system. A complete system consists of:

1. An emulator pod (including among other things, the host-to-pod parallel cable and power supply)
2. A processor module
3. A device adapter
4. A transition socket

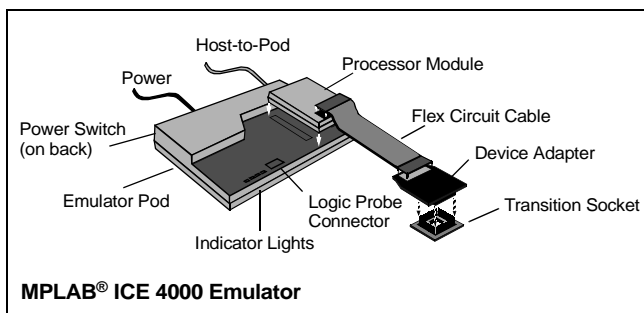
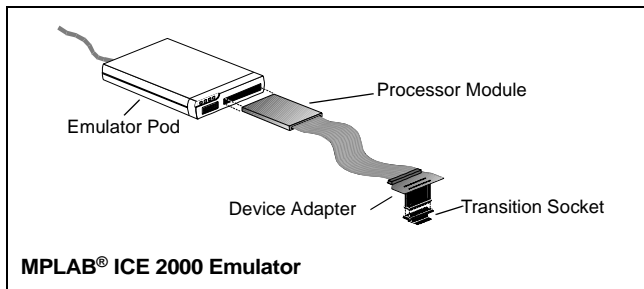

An MPLAB ICE emulator system is ordered as separate components. Knowing the terms will make it easy to order and use the MPLAB ICE emulator system. Read more about each component.

Emulator Pod

The MPLAB ICE 2000 and MPLAB ICE 4000 are full-featured emulator pods containing a main board with an additional board for expanded trace memory and complex control logic. The pods come with a standard parallel interface cable that connects the pods to the parallel port of the PC and a power supply. MPLAB ICE 4000 also includes a USB interface cable that connects the pod to the USB port.

Processor Module

The processor module is a PICmicro, device-specific module that is inserted into the emulator pod. The processor module contains the emulator chip, logic and low-voltage circuitry. A flex cable extends from the processor module and is connected to the device adapter at the target application.

Device Adapter

The device adapter provides a common interface for the PICmicro MCU being emulated. This adapter contains a special device that provides an oscillator clock allowing the user to accurately emulate the RC characteristics of the PICmicro MCU. The device adapter provides emulation support for standard DIP and PLCC styles. For emulation support of other packages, a transition socket is needed along with the device adapter.

Transition Socket

The transition sockets are available in various styles to allow the common device adapter to be translated to support surface-mount packages, such as SOIC, SSOP, PQFP, TQFP and MLF.

Development Tools Ordering Guide

PRO MATE® II Programmer

The PRO MATE II Programmer (DV007003) is Microchip's production rated programmer which can be operated stand-alone or with a PC using MPLAB IDE (included free). It comes complete with accessories needed to connect to a host system including a power supply and cables, and it gives the developer complete control over the programming session. Each PRO MATE II Programmer requires a socket module (to be purchased separately), which can be selected from the following chart by identifying the devices for programming and then picking the appropriate part number from the PRO MATE II Programmer Socket Modules column. In-Circuit Serial Programming™ (ICSP™) can also be added to the PRO MATE II Programmer by ordering Socket Module AC004004.

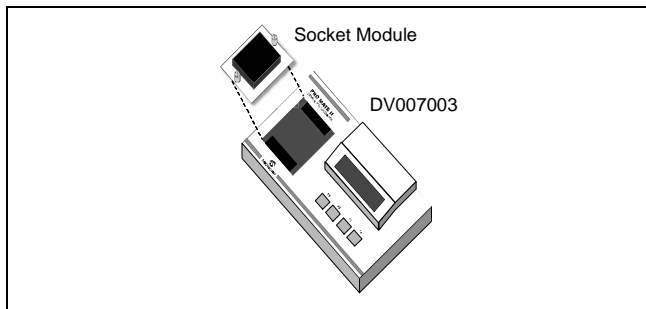

In-Circuit Debuggers – MPLAB® ICD 2

MPLAB ICD 2 is a low cost, FLASH-based development tool that connects between the PC and the designer's target board allowing direct in-circuit debugging of the PICmicro target microcontroller. Programs can be executed in real time or single step, watch variables established, break points set, memory read/writes accomplished and more. The MPLAB ICD 2 can also be used as a development programmer for the microcontrollers.

MPLAB® ICE 2000 and MPLAB® ICE 4000 Emulator Systems, PRO MATE® II Programmer Socket Modules, MPLAB® In-Circuit Debugger, Software Tools, Programmers and Demonstration Boards

		MPLAB® ICE 2000 System (1)				MPLAB® ICE 4000 System (2)							
Part Number	Lead Count/ Pkg Type	Processor Module	Device Adapters	Transition Socket	Processor Module	Device Adapters	Transition Socket	PRO MATE® II Socket Module (3,4)	PICSTART® Plus (5)	MPLAB® ICD 2 (6, 7)	MPLAB® CXX Compiler	Demonstration Boards or Evaluation Kits (9)	
Analog Interface Development Tools													
MCP2120	14P											DM163008	
MCP2150	18P											DM163008	
MCP250XX	14P							AC254001				DV250501	
MCP250XX	14SO							AC254001					
MCP2510	18P											DV251001	
PICmicro® Microcontroller Development Tools													
PIC12C508	8P, 8JW	PCM16XA0	DVA12XP080	XLT08SO				AC124001	✓			DM163001, DVMCPA	
PIC12C508	8SM	PCM16XA0	DVA12XP080	XLT08SO				AC124001					
PIC12C508A	8P, 8JW	PCM16XA0	DVA12XP080	XLT08SO				AC124001	✓			DM163001, DVMCPA	
PIC12C508A	8SM	PCM16XA0	DVA12XP080	XLT08SO				AC124001					
PIC12C508A	8SN	PCM16XA0	DVA12XP080	XLT08SO				AC164026					
PIC12C508A	8MF	PCM16XA0	DVA12XP080	XLT08DFN				AC124001 AC164032	AC164032				
PIC12C509	8P, 8JW	PCM16XA0	DVA12XP080	XLT08SO				AC124001	✓			DM163001, DVMCPA	
PIC12C509	8SM	PCM16XA0	DVA12XP080	XLT08SO				AC124001					
PIC12C509A	8P, 8JW	PCM16XA0	DVA12XP080	XLT08SO				AC124001	✓			DM163001, DVMCPA	
PIC12C509A	8SM	PCM16XA0	DVA12XP080	XLT08SO				AC124001					
PIC12C509A	8SN	PCM16XA0	DVA12XP080	XLT08SO				AC164026					
PIC12C509A	8MF	PCM16XA0	DVA12XP080	XLT08DFN				AC124001 AC164032	AC164032				
PIC12C671	8P, 8JW	PCM12XA0	DVA12XP081	XLT08SO				AC124001	✓				
PIC12C671	8SM	PCM12XA0	DVA12XP081	XLT08SO				AC124001					
PIC12C671	8MF	PCM12XA0	DVA12XP081	XLT08DFN				AC124001 AC164032	AC164032				
PIC12C672	8P, 8JW	PCM12XA0	DVA12XP081	XLT08SO				AC124001	✓				
PIC12C672	8SM	PCM12XA0	DVA12XP081	XLT08SO				AC124001					
PIC12C672	8MF	PCM12XA0	DVA12XP081	XLT08DFN				AC124001 AC164032	AC164032				
PIC12CE518	8P, 8JW	PCM16XA0	DVA12XP080	XLT08SO				AC124001	✓				
PIC12CE518	8SM	PCM16XA0	DVA12XP080	XLT08SO				AC124001					
PIC12CE518	8SN	PCM16XA0	DVA12XP080	XLT08SO				AC164026					
PIC12CE519	8P, 8JW	PCM16XA0	DVA12XP080	XLT08SO				AC124001	✓				
PIC12CE519	8SM	PCM16XA0	DVA12XP080	XLT08SO				AC124001					
PIC12CE519	8SN	PCM16XA0	DVA12XP080	XLT08SO				AC164026					
PIC12CE673	8P, 8JW	PCM12XA0	DVA12XP081					AC124001					
PIC12CE674	8P, 8JW	PCM12XA0	DVA12XP081					AC124001					
PIC12F629	8P	PCM12XB0	DVA12XP081	XLT08SO				AC124001	✓	AC162050 AC162050		DM163014, DV164101	
PIC12F629	8SN	PCM12XB0	DVA12XP081	XLT08SO				AC164026					
PIC12F629	8MF	PCM12XB0	DVA12XP081	XLT08DFN				AC124001 AC164032	AC164032	AC162050			

Development Tools Ordering Guide

MPLAB® ICE 2000 and MPLAB® ICE 4000 Emulator Systems, PRO MATE® II Programmer Socket Modules, MPLAB® In-Circuit Debugger, Software Tools, Programmers and Demonstration Boards

MPLAB® ICE 2000 System (1)			MPLAB® ICE 4000 System (2)				MPLAB® ICE 2000 System (3)					
Part Number	Lead Count/ Pkg Type	Processor Module	Device Adapters	Transition Socket	Processor Module	Device Adapters	Transition Socket	PRO MATE® II Socket/Module (3,4)	PICSTART® Plus (5)	MPLAB® ICD 2 (6, 7)	MPLAB® CXX Compiler	Demonstration Boards or Evaluation Kits (9)
PIC12F675	8P	PCM12XB0	DVA12XP081	XLT08SO				AC124001	✓	AC162050		DM163014, DV164101
PIC12F675	8SN	PCM12XB0	DVA12XP081	XLT08SO				AC164026		AC162050		
PIC12F675	8MF	PCM12XB0	DVA12XP081	XLT08DFN				AC124001 AC164032	AC164032	AC162050		
PIC14000	28SP, 28JW	PCM14XA0	DVA14XP280	XLT28SO				AC144001	✓			DM143001
PIC14000	28SO	PCM14XA0	DVA14XP280	XLT28SO				AC144002				
PIC14000	28SS	PCM14XA0	DVA14XP280	XLT28SS				AC144002				
PIC16C52	18P	PCM16XA0	DVA16XP180	XLT18SO				AC164001	✓			DM163001
PIC16C52	18SO	PCM16XA0	DVA16XP180	XLT18SO				AC164002				
PIC16C54/ 54A,54C	18P, 18JW	PCM16XA0	DVA16XP180	XLT18SO				AC164001	✓			DM163001
PIC16C54/ 54A,54C	18SO	PCM16XA0	DVA16XP180	XLT18SO				AC164002				
PIC16C54/ 54A,54C	20SS	PCM16XA0	DVA16XP180	XLT20SS				AC164015				
PIC16C55/55A	28P, 28JW	PCM16XA0	DVA16XP280	XLT28XP				AC164001	✓			DM163001
PIC16C55/55A	28SP	PCM16XA0	DVA16XP280	XLT28XP				AC164001	✓			DM163001
PIC16C55/55A	28SO	PCM16XA0	DVA16XP280	XLT28SO				AC164002				
PIC16C55/55A	28SS	PCM16XA0	DVA16XP280	XLT28SS2				AC164015				
PIC16C56/56A	18P, 18JW	PCM16XA0	DVA16XP180	XLT18SO				AC164001	✓			DM163001
PIC16C56/56A	18SO	PCM16XA0	DVA16XP180	XLT18SO				AC164002				
PIC16C56/56A	20SS	PCM16XA0	DVA16XP180	XLT20SS				AC164015				
PIC16C57/57C	28P, 28JW	PCM16XA0	DVA16XP280	XLT28XP				AC164001	✓			DM163001
PIC16C57/57C	28SP	PCM16XA0	DVA16XP280	XLT28XP				AC164001	✓			DM163001
PIC16C57/57C	28SO	PCM16XA0	DVA16XP280	XLT28SO				AC164002				
PIC16C57/57C	28SS	PCM16XA0	DVA16XP280	XLT28SS2				AC164015				
PIC16C58A/ 58B	18P, 18JW	PCM16XA0	DVA16XP180	XLT18SO				AC164001	✓			DM163001
PIC16C58A/ 58B	18SO	PCM16XA0	DVA16XP180	XLT18SO				AC164002				
PIC16C58A/ 58B	20SS	PCM16XA0	DVA16XP180	XLT20SS				AC164015				
PIC16C62A	28P, 28JW	PCM16XB1	DVA16XP282	XLT28XP				AC164001	✓			DM163001
PIC16C62A	28SO	PCM16XB1	DVA16XP282	XLT28SO				AC164001	✓			DM163001
PIC16C62A	28SS	PCM16XB1	DVA16XP282	XLT28SS				AC164015				
PIC16C62B	28SP, 28JW	PCM16XE1	DVA16XP282	XLT28QFN				AC164012	✓			DM163022
PIC16C62B	28ML	PCM16XE1	DVA16XP282	XLT28QFN				AC164012				
PIC16C62B	28SO	PCM16XE1	DVA16XP282	XLT28SO				AC164017				
PIC16C62B	28SS	PCM16XE1	DVA16XP282	XLT28SS				AC164031	AC164031			DM163022
PIC16C63	28SP, 28JW	PCM16XB1	DVA16XP282	XLT28SO				AC164012				DM163022, DVMCPA
PIC16C63	28SO	PCM16XB1	DVA16XP282	XLT28SO				AC164017				

Cross Reference

MPLAB® ICE 2000 and MPLAB® ICE 4000 Emulator Systems, PRO MATE® II Programmer Socket Modules, MPLAB® In-Circuit Debugger, Software Tools, Programmers and Demonstration Boards

Part Number	MPLAB® ICE 2000 System (1)					MPLAB® ICE 4000 System (2)					PICSTART® Plus (5)	MPLAB® ICD 2 (6, 7)	MPLAB® CXX Compiler	Demonstration Boards or Evaluation Kits (9)
	Lead Count/ Pkg Type	Processor Module	Device Adapters	Transition Socket	Processor Module	Device Adapters	Transition Socket	PRO MATE® II Socket Module (3,4)						
PIC16C63A	28SP, 28JW	PCM16XE1	DVA16XP282	XLT28QFN				AC164012 AC164012 AC164031	✓				DM163022	
PIC16C63A	28ML	PCM16XE1	DVA16XP282	XLT28QFN				AC164012 AC164012 AC164031	✓				DM163022	
PIC16C63A	28SO	PCM16XE1	DVA16XP282	XLT28SO				AC164012 AC164012 AC164031	✓				DM163022	
PIC16C63A	28SS	PCM16XE1	DVA16XP282	XLT28SS				AC164012 AC164012 AC164031	✓				DM163022	
PIC16C64A	40P, 40JW	PCM16XB1	DVA16XP401					AC164012 AC164012 AC164013	✓				DM163022	
PIC16C64A	44L	PCM16XB1	DVA16XL441	XLT44PT				AC164012 AC164012 AC164013	✓				DM163022	
PIC16C64A	44PQ	PCM16XB1	DVA16PQ441	XLT44PT				AC164012 AC164012 AC164013	✓				DM163022	
PIC16C64A	44PT	PCM16XB1	DVA16PQ441	XLT44PT				AC164012 AC164012 AC164013	✓				DM163022	
PIC16C65A	40P, 40JW	PCM16XB1	DVA16XP401					AC164012 AC164012 AC164013	✓				DM163022	
PIC16C65A	44L	PCM16XB1	DVA16XL441	XLT44PT				AC164012 AC164012 AC164013	✓				DM163022	
PIC16C65A	44PQ	PCM16XB1	DVA16PQ441	XLT44PT				AC164012 AC164012 AC164013	✓				DM163022	
PIC16C65A	44PT	PCM16XB1	DVA16PQ441	XLT44PT				AC164012 AC164012 AC164013	✓				DM163022	
PIC16C65B	40P, 40JW	PCM16XE1	DVA16XP401					AC164012 AC164012 AC164013	✓				DM163022	
PIC16C65B	44L	PCM16XE1	DVA16XL441	XLT44PT				AC164012 AC164012 AC164013	✓				DM163022	
PIC16C65B	44PQ	PCM16XE1	DVA16PQ441	XLT44PT				AC164012 AC164012 AC164013	✓				DM163022	
PIC16C65B	44PT	PCM16XE1	DVA16PQ441	XLT44PT				AC164012 AC164012 AC164013	✓				DM163022	
PIC16C66	28SP, 28JW	PCM16XE1	DVA16XP282	XLT28SO				AC164012 AC164012 AC164017	✓				DM163022	
PIC16C66	28SO	PCM16XE1	DVA16XP282	XLT28SO				AC164012 AC164012 AC164017	✓				DM163022	
PIC16C67	40P, 40JW	PCM16XE1	DVA16XP401					AC164012 AC164012 AC164013	✓				DM163022	
PIC16C67	44L	PCM16XE1	DVA16XL441	XLT44PT				AC164012 AC164012 AC164013	✓				DM163022	
PIC16C67	44PQ	PCM16XE1	DVA16PQ441	XLT44PT				AC164012 AC164012 AC164013	✓				DM163022	
PIC16C67	44PT	PCM16XE1	DVA16PQ441	XLT44PT				AC164012 AC164012 AC164013	✓				DM163022	
PIC16C71	18P, 18JW	PCM16XF0	DVA16XP180					AC164010 AC164010	✓				DM163001	
PIC16C71	18SO	PCM16XF0	DVA16XP180	XLT18SO				AC164010 AC164010	✓				DM163022	
PIC16C72	28SP, 28JW	PCM16XB1	DVA16XP282	XLT28SO				AC164010 AC164010	✓				DM163022	
PIC16C72	28SO	PCM16XB1	DVA16XP282	XLT28SO				AC164010 AC164010	✓				DM163022	
PIC16C72	28SS	PCM16XB1	DVA16XP282	XLT28SS				AC164010 AC164010	✓				DM163022	
PIC16C72A	28SP, 28JW	PCM16XE1	DVA16XP282	XLT28QFN				AC164010 AC164010 AC164012	✓				DM163022	
PIC16C72A	28ML	PCM16XE1	DVA16XP282	XLT28QFN				AC164010 AC164010 AC164012	✓				DM163022	
PIC16C72A	28SO	PCM16XE1	DVA16XP282	XLT28SO				AC164010 AC164010 AC164012	✓				DM163022	
PIC16C72A	28SS	PCM16XE1	DVA16XP282	XLT28SS				AC164010 AC164010 AC164012	✓				DM163022	
PIC16C73A	28SP, 28JW	PCM16XB1	DVA16XP282	XLT28SO				AC164010 AC164010	✓				DM163022	
PIC16C73A	28SO	PCM16XB1	DVA16XP282	XLT28SO				AC164010 AC164010	✓				DM163022	
PIC16C73B	28SP, 28JW	PCM16XE1	DVA16XP282	XLT28QFN				AC164010 AC164010 AC164012	✓				DM163022	
PIC16C73B	28ML	PCM16XE1	DVA16XP282	XLT28QFN				AC164010 AC164010 AC164012	✓				DM163022	
PIC16C73B	28SO	PCM16XE1	DVA16XP282	XLT28SO				AC164010 AC164010	✓				DM163022	
PIC16C73B	28SS	PCM16XE1	DVA16XP282	XLT28SS				AC164010 AC164010	✓				DM163022	

Development Tools Ordering Guide

MPLAB® ICE 2000 and MPLAB® ICE 4000 Emulator Systems, PRO MATE® II Programmer Socket Modules, MPLAB® In-Circuit Debugger, Software Tools, Programmers and Demonstration Boards

		MPLAB® ICE 2000 System (1)					MPLAB® ICE 4000 System (2)								
Part Number	Lead Count/ Pkg Type	Processor Module	Device Adapters	Transition Socket	Processor Module	Device Adapters	Transition Socket	Processor Module	Device Adapters	Transition Socket	PRO MATE® II Socket Module (3,4)	PICSTART® Plus (5)	MPLAB® ICD 2 (6, 7)	MPLAB® CXX Compiler	Demonstration Boards or Evaluation Kits (9)
PIC16C74A	40P, 40JW	PCM16XB1	DVA16XP401								AC164012	✓			DM163022
PIC16C74A	44L	PCM16XB1	DVA16XL441								AC164013				
PIC16C74A	44PQ	PCM16XB1	DVA16PQ441	XLT44PT							AC164014				
PIC16C74A	44PT	PCM16XB1	DVA16PQ441	XLT44PT							AC164020				
PIC16C74B	40P, 40JW	PCM16XE1	DVA16XP401								AC164012	✓			DM163022
PIC16C74B	44L	PCM16XE1	DVA16XL441								AC164013				
PIC16C74B	44PQ	PCM16XE1	DVA16PQ441	XLT44PT							AC164014				
PIC16C74B	44PT	PCM16XE1	DVA16PQ441	XLT44PT							AC164020				
PIC16C76	28SP, 28JW	PCM16XE1	DVA16XP282								AC164012	✓			DM163022
PIC16C76	28SO	PCM16XE1	DVA16XP282	XLT28SO							AC164017				
PIC16C77	40P, 40JW	PCM16XE1	DVA16XP401								AC164012	✓			DM163022
PIC16C77	44L	PCM16XE1	DVA16XL441								AC164013				
PIC16C77	44PQ	PCM16XE1	DVA16PQ441	XLT44PT							AC164014				
PIC16C77	44PT	PCM16XE1	DVA16PQ441	XLT44PT							AC164020				
PIC16C432	20P, 20JW	PCM16YB0	DVA16XP201								AC164029				DM163005
PIC16C432	20SS	PCM16YB0	DVA16XP201	XLT20SS1							AC164029				DM163007_DM163011
PIC16C433	18P, 18JW	PCM16YC0	DVA16XP185								AC164029				DM163005
PIC16C433	18SS	PCM16YC0	DVA16XP185	XLT18SO							AC164030				
PIC16C505	14P, 14JW	PCM16XA0	DVA16XP140								AC124001	✓			
PIC16C505	14SL	PCM16XA0	DVA16XP140	XLT14SO							AC164026				
PIC16C554	18P, 18JW	PCM16XC0	DVA16XP180								AC164010	✓			DM163001
PIC16C554	18SO	PCM16XC0	DVA16XP180	XLT18SO							AC164010				
PIC16C554	18SS	PCM16XC0	DVA16XP180	XLT20SS							AC164018				
PIC16C557	28P										AC164001				
PIC16C557	28SO										AC164002				
PIC16C558	18P, 18JW	PCM16XC0	DVA16XP180								AC164010	✓			DM163001
PIC16C558	18SO	PCM16XC0	DVA16XP180	XLT18SO							AC164010				
PIC16C558	18SS	PCM16XC0	DVA16XP180	XLT20SS							AC164018				
PIC16C620/ 620A	18P, 18JW	PCM16XC0	DVA16XP180								AC164010	✓			DM163001
PIC16C620/ 620A	18SO	PCM16XC0	DVA16XP180	XLT18SO							AC164010				
PIC16C620/ 620A	20SS	PCM16XC0	DVA16XP180	XLT20SS							AC164018				
PIC16C621/ 621A	18P, 18JW	PCM16XC0	DVA16XP180								AC164010	✓			DM163001
PIC16C621/ 621A	18SO	PCM16XC0	DVA16XP180	XLT18SO							AC164010				
PIC16C621/ 621A	20SS	PCM16XC0	DVA16XP180	XLT20SS							AC164018				

Cross Reference

MPLAB® ICE 2000 and MPLAB® ICE 4000 Emulator Systems, PRO MATE® II Programmer Socket Modules, MPLAB® In-Circuit Debugger, Software Tools, Programmers and Demonstration Boards

Part Number	Lead Count/ Pkg Type	MPLAB® ICE 2000 System (1)				MPLAB® ICE 4000 System (2)				PICSTART® Plus (5)	MPLAB® ICD 2 (6, 7)	MPLAB® CXX Compiler	Demonstration Boards or Evaluation Kits (8)
		Processor Module	Device Adapters	Transition Socket	Processor Module	Device Adapters	Transition Socket	PRO MATE® II Socket Module (3,4)					
PIC16C622/ 622A	18P, 18JW	PCM16XC0	DVA16XP180	XLT18SO				AC164010	✓			DM163001	
PIC16C622/ 622A	18SO	PCM16XC0	DVA16XP180	XLT18SO			AC164010						
PIC16C622/ 622A	20SS	PCM16XC0	DVA16XP180	XLT20SS			AC164018						
PIC16C642	28SP, 28JW	PCM16XD0	DVA16XP282	XLT28SO			AC164012		✓			DM163022	
PIC16C642	28SO	PCM16XD0	DVA16XP282	XLT28SO			AC164017						
PIC16C662	40P, 40JW	PCM16XD0	DVA16XP401				AC164012		✓			DM163022	
PIC16C662	44L	PCM16XD0	DVA16XL441				AC164013						
PIC16C662	44PQ	PCM16XD0	DVA16PQ441	XLT44PT			AC164014						
PIC16C662	44PT	PCM16XD0	DVA16PQ441	XLT44PT			AC164020						
PIC16C710	18P, 18JW	PCM16XF0	DVA16XP180				AC164010		✓			DM163001	
PIC16C710	18SO	PCM16XF0	DVA16XP180	XLT18SO			AC164010						
PIC16C710	20SS	PCM16XF0	DVA16XP180	XLT20SS			AC164018						
PIC16C711	18P, 18JW	PCM16XF0	DVA16XP180				AC164010		✓			DM163001	
PIC16C711	18SO	PCM16XF0	DVA16XP180	XLT18SO			AC164010						
PIC16C711	20SS	PCM16XF0	DVA16XP180	XLT20SS			AC164018						
PIC16C712	18P, 18JW	PCM16XE1	DVA16XP182				AC164010		✓			DM163001	
PIC16C712	18SO	PCM16XE1	DVA16XP182	XLT18SO			AC164010						
PIC16C712	20SS	PCM16XE1	DVA16XP182	XLT20SS			AC164018						
PIC16C715	18P, 18JW	PCM16XG0	DVA16XP180				AC164010		✓			DM163001	
PIC16C715	18SO	PCM16XG0	DVA16XP180	XLT18SO			AC164010						
PIC16C715	20SS	PCM16XG0	DVA16XP180	XLT20SS			AC164018						
PIC16C716	18P, 18JW	PCM16XE1	DVA16XP182				AC164010		✓			DM163001	
PIC16C716	18SO	PCM16XE1	DVA16XP182	XLT18SO			AC164010						
PIC16C716	20SS	PCM16XE1	DVA16XP182	XLT20SS			AC164018						
PIC16C717	18P, 18JW	PCM16XN1	DVA16XP184				AC164010		✓			DM163001	
PIC16C717	18SO	PCM16XN1	DVA16XP184	XLT18SO			AC164010						
PIC16C717	20SS	PCM16XN1	DVA16XP184	XLT20SS			AC164018						
PIC16C745	28SP, 28JW	PCM16XQ1	DVA16XP282	XLT28SO			AC164012		✓			DM163010	
PIC16C745	28SO	PCM16XQ1	DVA16XP282	XLT28SO			AC164017						
PIC16C765	40P	PCM16XQ1	DVA16XP401				AC164012		✓			DM163010	
PIC16C765	44L	PCM16XQ1	DVA16XL441				AC164013		✓				
PIC16C765	44PT	PCM16XQ1	DVA16PQ441	XLT44PT			AC164020						
PIC16C770	20P	PCM16XN1	DVA16XP200				AC164028		✓			DM163001	
PIC16C770	20SO	PCM16XN1	DVA16XP200	XLT20SO1			AC164028						
PIC16C770	20SS	PCM16XN1	DVA16XP200	XLT20SS1			AC164018						
PIC16C771	20P	PCM16XN1	DVA16XP200				AC164028		✓			DM163001	
PIC16C771	20SO	PCM16XN1	DVA16XP200	XLT20SO1			AC164028						
PIC16C771	20SS	PCM16XN1	DVA16XP200	XLT20SS1			AC164018						

Development Tools Ordering Guide

MPLAB® ICE 2000 and MPLAB® ICE 4000 Emulator Systems, PRO MATE® II Programmer Socket Modules, MPLAB® In-Circuit Debugger, Software Tools, Programmers and Demonstration Boards

				MPLAB® ICE 2000 System (1)				MPLAB® ICE 4000 System (2)							
Part Number	Lead Count/ Pkg Type	Processor Module	Device Adapters	Transition Socket	Processor Module	Device Adapters	Transition Socket	Processor Module	Device Adapters	Transition Socket	PRO MATE® II Socket Module (3,4)	PICSTART® Plus (5)	MPLAB® ICD 2 (6, 7)	MPLAB® CXX Compiler	Demonstration Boards or Evaluation Kits (9)
PIC16C773	28SP, 28JW	PCM16XL0	DVA16XP282	XLT28SO							AC164012	✓			DM163022
PIC16C773	28SO	PCM16XL0	DVA16XP282	XLT28SS							AC164017				
PIC16C773	28SS	PCM16XL0	DVA16XP282								AC164021				
PIC16C774	40P, 40JW	PCM16XL0	DVA16XP401								AC164012	✓			DM163022
PIC16C774	44L	PCM16XL0	DVA16XL441	XLT44PT							AC164013				
PIC16C774	44PQ	PCM16XL0	DVA16PQ441								AC164014				
PIC16C774	44PT	PCM16XL0	DVA16PQ441	XLT44PT							AC164020				
PIC16C781	20P, 20JW	PCM16XW0	DVA16XP202	XLT20SO1							AC164028	✓			DM163012
PIC16C781	20SO	PCM16XW0	DVA16XP202	XLT20SS1							AC164028				
PIC16C781	20SS	PCM16XW0	DVA16XP202								AC164018				
PIC16C782	20P, 20JW	PCM16XW0	DVA16XP202	XLT20SO1							AC164028	✓			DM163012
PIC16C782	20SO	PCM16XW0	DVA16XP202	XLT20SS1							AC164018				
PIC16C782	20SS	PCM16XW0	DVA16XP202								AC164025	✓			
PIC16C923	64SP	PCM16XJ0	DVA16XP640	XLT64PT1							AC164023				DM163003
PIC16C923	64PT	PCM16XJ0	DVA16PQ640								AC164022	AC164024			
PIC16C923	68L, 68CL	PCM16XJ0	DVA16XL680								AC164022				
PIC16C924	64SP	PCM16XJ0	DVA16XP640	XLT64PT1							AC164025	✓			
PIC16C924	64PT	PCM16XJ0	DVA16PQ640								AC164023				
PIC16C924	68L, 68CL	PCM16XJ0	DVA16XL680								AC164022	AC164024			DM163003
PIC16C925	64PT	PCM16XT0	DVA16PQ640	XLT64PT1							AC164023				
PIC16C925	68L	PCM16XT0	DVA16XL680								AC164022	AC164024			DM163003
PIC16C926	64PT	PCM16XT0	DVA16PQ640	XLT64PT1							AC164023				
PIC16C926	68L	PCM16XT0	DVA16XL680								AC164022	AC164024			DM163003
PIC16CE623	18P, 18JW	PCM16XC0	DVA16XP180	XLT18SO							AC164010	✓			DM163001
PIC16CE623	18SO	PCM16XC0	DVA16XP180	XLT20SS							AC164010				
PIC16CE623	20SS	PCM16XC0	DVA16XP180								AC164018				
PIC16CE624	18P, 18JW	PCM16XC0	DVA16XP180	XLT18SO							AC164010	✓			DM163001
PIC16CE624	18SO	PCM16XC0	DVA16XP180	XLT20SS							AC164010				
PIC16CE624	20SS	PCM16XC0	DVA16XP180								AC164018				
PIC16CE625	18P, 18JW	PCM16XC0	DVA16XP180	XLT18SO							AC164010	✓			DM163001
PIC16CE625	18SO	PCM16XC0	DVA16XP180	XLT20SS							AC164010				
PIC16CE625	20SS	PCM16XC0	DVA16XP180								AC164018				
PIC16F72	28SP, 28JW	PCM16XS2	DVA16XP282	XLT28SO							AC164012	✓			DM163022
PIC16F72	28SO	PCM16XS2	DVA16XP282	XLT28SS							AC164017				
PIC16F72	28SS	PCM16XS2	DVA16XP282								AC164021				
PIC16F73	28SP, 28JW	PCM16XS2	DVA16XP282	XLT28QFN							AC164012	✓			DM163022
PIC16F73	28ML	PCM16XS2	DVA16XP282	XLT28SO							AC164012		AC164031		
PIC16F73	28SO	PCM16XS2	DVA16XP282	XLT28SS							AC164017				
PIC16F73	28SS	PCM16XS2	DVA16XP282								AC164021				

Cross Reference

MPLAB® ICE 2000 and MPLAB® ICE 4000 Emulator Systems, PRO MATE® II Programmer Socket Modules, MPLAB® In-Circuit Debugger, Software Tools, Programmers and Demonstration Boards

				MPLAB® ICE 2000 System (1)				MPLAB® ICE 4000 System (2)							
Part Number	Lead Count/ Pkg Type	Processor Module	Device Adapters	Transition Socket	Processor Module	Device Adapters	Transition Socket	Processor Module	Device Adapters	Transition Socket	PRO MATE® II Socket Module (3,4)	PICSTART® Plus (5)	MPLAB® ICD 2 (6, 7)	MPLAB® CXX Compiler	Demonstration Boards or Evaluation Kits (9)
PIC16F74	40P	PCM16XS2	DVA16XP401								AC164012	✓			DM163022
PIC16F74	44L	PCM16XS2	DVA16XL441								AC164013				
PIC16F74	44PT	PCM16XS2	DVA16PQ441	XLT44PT							AC164020				
PIC16F76	28SP, 28JW	PCM16XS2	DVA16XP282								AC164012	✓			DM163022
PIC16F76	28ML	PCM16XS2	DVA16XP282	XLT28QFN							AC164012 AC164031				
PIC16F76	28SO	PCM16XS2	DVA16XP282	XLT28SO							AC164017				
PIC16F77	40P, 40JW	PCM16XS2	DVA16XP401								AC164012	✓			DM163022
PIC16F77	44L	PCM16XS2	DVA16XL441								AC164013				
PIC16F77	44PQ	PCM16XS2	DVA16PQ441	XLT44PT							AC164014				
PIC16F77	44PT	PCM16XS2	DVA16PQ441	XLT44PT							AC164020				
PIC16F83	18P	PCM16XH1	DVA16XP180								AC164010	✓			DM163001
PIC16F83	18SO	PCM16XH1	DVA16XP180	XLT18SO							AC164010				
PIC16F84	18P	PCM16XH1	DVA16XP180								AC164010	✓			DM163001
PIC16F84	18SO	PCM16XH1	DVA16XP180	XLT18SO							AC164010				
PIC16F84A	18P	PCM16XH1	DVA16XP180								AC164010	✓			DM163001
PIC16F84A	18SO	PCM16XH1	DVA16XP180	XLT18SO							AC164010				
PIC16F84A	20SS	PCM16XH1	DVA16XP180	XLT20SS							AC164018				
PIC16F87	18P	PCM16YG0*	DVA16XP186								AC164010	✓*	✓*		DM163014
PIC16F87	18SO	PCM16YG0*	DVA16XP186	XLT18SO							AC164010		✓*		
PIC16F87	20SS	PCM16YG0*	DVA16XP186	XLT20SS							AC164018		✓*		
PIC16F87	28ML	PCM16YG0*	DVA16XP186	XLT28QFN2*							AC164010 AC164033		✓*		
PIC16F88	18P	PCM16YG0*	DVA16XP186								AC164010	✓*	✓*		DM163014
PIC16F88	18SO	PCM16YG0*	DVA16XP186	XLT18SO							AC164010		✓*		
PIC16F88	20SS	PCM16YG0*	DVA16XP186	XLT20SS							AC164018		✓*		
PIC16F88	28ML	PCM16YG0*	DVA16XP186	XLT28QFN2*							AC164010 AC164033		✓*		
PIC16F627	18P, 18JW	PCM16XP0	DVA16XP183								AC164010	✓	AC162053*		DM163001
PIC16F627	18SO	PCM16XP0	DVA16XP183	XLT18SO							AC164010		AC162053*		
PIC16F627	20SS	PCM16XP0	DVA16XP183	XLT20SS							AC164018		AC162053*		
PIC16F627A	18P	PCM16YF0*	DVA16XP183								AC164010	✓*	AC162053*		DM163014
PIC16F627A	18SO	PCM16YF0*	DVA16XP183	XLT18SO							AC164010		AC162053*		
PIC16F627A	20SS	PCM16YF0*	DVA16XP183	XLT20SS							AC164018		AC162053*		
PIC16F627A	28ML	PCM16YF0*	DVA16XP183	XLT28QFN2*							AC164010 AC164033		AC162053*		
PIC16F628	18P, 18JW	PCM16XP0	DVA16XP183								AC164010	✓	AC162053*		DM163001
PIC16F628	18SO	PCM16XP0	DVA16XP183	XLT18SO							AC164010		AC162053*		
PIC16F628	20SS	PCM16XP0	DVA16XP183	XLT20SS							AC164018		AC162053*		

Development Tools Ordering Guide

MPLAB® ICE 2000 and MPLAB® ICE 4000 Emulator Systems, PRO MATE® II Programmer Socket Modules, MPLAB® In-Circuit Debugger, Software Tools, Programmers and Demonstration Boards

Part Number	Lead Count/ Pkg Type	MPLAB® ICE 2000 System (1)				MPLAB® ICE 4000 System (2)				PICSTART® Plus (5)	MPLAB® ICD 2 (6, 7)	MPLAB® CXX Compiler	Demonstration Boards or Evaluation Kits (9)
		Processor Module	Device Adapters	Transition Socket	Processor Module	Device Adapters	Transition Socket	PRO MATE® II Socket Module (3,4)					
PIC16F628A	18P	PCM16YF0*	DVA16XP183	XLT18SO				AC164010	✓*	AC162053*		DM163014	
PIC16F628A	18SO	PCM16YF0*	DVA16XP183	XLT18SO				AC164010		AC162053*			
PIC16F628A	20SS	PCM16YF0*	DVA16XP183	XLT20SS				AC164018		AC162053*			
PIC16F628A	28ML	PCM16YF0*	DVA16XP183	XLT28QFN2*				AC164010 AC164033	AC164033	AC162053*			
PIC16F630	14P	PCM16YD0	DVA16XP141	XLT14SO				AC124001	✓	AC162052		DM163014, DV164101	
PIC16F630	14SO	PCM16YD0	DVA16XP141	XLT14SO				AC164026		AC162052			
PIC16F630	14ST	PCM16YD0	DVA16XP141	XLT14SS				AC164026		AC162052			
PIC16F648A	18P	PCM16YF0*	DVA16XP183	XLT18SO				AC164010	✓*	AC162053		DM163014	
PIC16F648A	18SO	PCM16YF0*	DVA16XP183	XLT18SO				AC164010		AC162053			
PIC16F648A	20SS	PCM16YF0*	DVA16XP183	XLT20SS				AC164018		AC162053			
PIC16F648A	28ML	PCM16YF0*	DVA16XP183	XLT28QFN2*				AC164010 AC164033	AC164033	AC162053			
PIC16F676	14P	PCM16YD0	DVA16XP141	XLT14SO				AC124001	✓	AC162052		DM163014, DV164101	
PIC16F676	14SO	PCM16YD0	DVA16XP141	XLT14SO				AC164026		AC162052			
PIC16F676	14ST	PCM16YD0	DVA16XP141	XLT14SS				AC164026		AC162052			
PIC16F818	18P	PCM16YE0	DVA16XP186	XLT18SO				AC164010	✓	✓		DM163014	
PIC16F818	18SO	PCM16YE0	DVA16XP186	XLT18SO				AC164010		✓			
PIC16F818	20SS	PCM16YE0	DVA16XP186	XLT20SS				AC164018		✓			
PIC16F818	28ML	PCM16YE0	DVA16XP186	XLT28QFN2*				AC164010 AC164033	AC164033	✓			
PIC16F819	18P	PCM16YE0	DVA16XP186	XLT18SO				AC164010	✓	✓		DM163014	
PIC16F819	18SO	PCM16YE0	DVA16XP186	XLT18SO				AC164010		✓			
PIC16F819	20SS	PCM16YE0	DVA16XP186	XLT20SS				AC164018		✓			
PIC16F819	28ML	PCM16YE0	DVA16XP186	XLT28QFN2*				AC164010 AC164033	AC164033	✓			
PIC16F870	28SP, 28JW	PCM16XR1	DVA16XP282	XLT28SO				AC164012	✓	✓		DM163022	
PIC16F870	28SO	PCM16XR1	DVA16XP282	XLT28SO				AC164017		✓			
PIC16F870	28SS	PCM16XR1	DVA16XP282	XLT28SS				AC164021		✓			
PIC16F871	40P	PCM16XR1	DVA16XP401	XLT44PT				AC164012	✓	✓		DM163022	
PIC16F871	44L	PCM16XR1	DVA16XL441					AC164013		✓			
PIC16F871	44PT	PCM16XR1	DVA16PQ441					AC164020		✓			
PIC16F872	28SP	PCM16XK1	DVA16XP282	XLT28SO				AC164012	✓	✓		DM163022	
PIC16F872	28SO	PCM16XK1	DVA16XP282	XLT28SO				AC164017		✓			
PIC16F872	28SS	PCM16XK1	DVA16XP282	XLT28SS				AC164021		✓			
PIC16F873	28SP	PCM16XK1	DVA16XP282	XLT28SO				AC164012	✓	✓		DM163022	
PIC16F873	28SO	PCM16XK1	DVA16XP282	XLT28SO				AC164017		✓			
PIC16F873A	28SP	PCM16XV0	DVA16XP282	XLT28SO				AC164012	✓	✓		DM163022	
PIC16F873A	28SO	PCM16XV0	DVA16XP282	XLT28SO				AC164017		✓			
PIC16F873A	28SS	PCM16XV0	DVA16XP282	XLT28SS				AC164021		✓			
PIC16F873A	28ML	PCM16XV0	DVA16XP282	XLT28QFN				AC164012 AC164031	AC164031	✓			

Cross Reference

MPLAB® ICE 2000 and MPLAB® ICE 4000 Emulator Systems, PRO MATE® II Programmer Socket Modules, MPLAB® In-Circuit Debugger, Software Tools, Programmers and Demonstration Boards

				MPLAB® ICE 2000 System (1)				MPLAB® ICE 4000 System (2)							
Part Number	Lead Count/ Pkg Type	Processor Module	Device Adapters	Transition Socket	Processor Module	Device Adapters	Transition Socket	Processor Module	Device Adapters	Transition Socket	PRO MATE® II Socket Module (3,4)	PICSTART® Plus (5)	MPLAB® ICD 2 (6, 7)	MPLAB® CXX Compiler	Demonstration Boards or Evaluation Kits (8)
PIC16F874	40P	PCM16XK1	DVA16XP401								AC164012	✓	✓		DM163022
PIC16F874	44L	PCM16XK1	DVA16XL441								AC164013	✓	✓		
PIC16F874	44PQ	PCM16XK1	DVA16PQ441	XLT44PT							AC164014	✓	✓		
PIC16F874	44PT	PCM16XK1	DVA16PQ441	XLT44PT							AC164020	✓	✓		
PIC16F874A	40P	PCM16XV0	DVA16XP401								AC164012	✓	✓		DM163022
PIC16F874A	44L	PCM16XV0	DVA16XL441								AC164013	✓	✓		
PIC16F874A	44PT	PCM16XV0	DVA16PQ441	XLT44PT							AC164020	✓	✓		
PIC16F876	28SP	PCM16XK1	DVA16XP282								AC164012	✓	✓		DM163022
PIC16F876	28SO	PCM16XK1	DVA16XP282	XLT28SO							AC164017	✓	✓		
PIC16F876A	28SP	PCM16XV0	DVA16XP282								AC164012	✓	✓		DM163022
PIC16F876A	28SO	PCM16XV0	DVA16XP282	XLT28SO							AC164017	✓	✓		
PIC16F876A	28SS	PCM16XV0	DVA16XP282	XLT28SS							AC164021	✓	✓		
PIC16F876A	28ML	PCM16XV0	DVA16XP282	XLT28QFN							AC164012 AC164031	✓	✓		
PIC16F877	40P	PCM16XK1	DVA16XP401								AC164012	✓	✓		DM163022
PIC16F877	44L	PCM16XK1	DVA16XL441								AC164013	✓	✓		
PIC16F877	44PQ	PCM16XK1	DVA16PQ441	XLT44PT							AC164014	✓	✓		
PIC16F877	44PT	PCM16XK1	DVA16PQ441	XLT44PT							AC164020	✓	✓		
PIC16F877A	40P	PCM16XV0	DVA16XP401								AC164012	✓	✓		DM163022
PIC16F877A	44L	PCM16XV0	DVA16XL441								AC164013	✓	✓		
PIC16F877A	44PT	PCM16XV0	DVA16PQ441	XLT44PT							AC164020	✓	✓		
PIC16F877A	44ML	PCM16XV0	DVA16XP401	XLT44QFN*							AC164012 AC164034*	✓	✓		
PIC16HV540	18P										AC164001	✓			
PIC16HV540	18SO										AC164002				
PIC16HV540	18SS										AC164015				
PIC17C42A	40P, 40JW	PCM17XA0	DVA17XP401								AC174001	✓		SW060010	DM163001
PIC17C42A	44L	PCM17XA0	DVA17XL441								AC174002			SW060010	
PIC17C42A	44PQ	PCM17XA0	DVA17PQ441	XLT44PT							AC174004			SW060010	
PIC17C42A	44PT	PCM17XA0	DVA17PQ441	XLT44PT							AC174005			SW060010	
PIC17C43	40P, 40JW	PCM17XA0	DVA17XP401								AC174001			SW060010	DM163001
PIC17C43	44L	PCM17XA0	DVA17XL441								AC174002			SW060010	
PIC17C43	44PQ	PCM17XA0	DVA17PQ441	XLT44PT							AC174004			SW060010	
PIC17C43	44PT	PCM17XA0	DVA17PQ441	XLT44PT							AC174005			SW060010	
PIC17C44	40P, 40JW	PCM17XA0	DVA17XP401								AC174001	✓		SW060010	DM163001
PIC17C44	44L	PCM17XA0	DVA17XL441								AC174002			SW060010	
PIC17C44	44PQ	PCM17XA0	DVA17PQ441	XLT44PT							AC174004			SW060010	
PIC17C44	44PT	PCM17XA0	DVA17PQ441	XLT44PT							AC174005			SW060010	
PIC17C752	68L	PCM17XA0	DVA17XL681								AC174001			SW060010	DM163001
PIC17C752	64PT	PCM17XA0	DVA17PQ641	XLT64PT2							AC174007	AC164024		SW060010	DM173001

Development Tools Ordering Guide

MPLAB® ICE 2000 and MPLAB® ICE 4000 Emulator Systems, PRO MATE® II Programmer Socket Modules, MPLAB® In-Circuit Debugger, Software Tools, Programmers and Demonstration Boards

Part Number	Lead Count/ Pkg Type	MPLAB® ICE 2000 System (1)				MPLAB® ICE 4000 System (2)				PRO MATE® II Socket Module (3,4)	PICSTART® Plus (5)	MPLAB® ICD 2 (6, 7)	MPLAB® CXX Compiler	Demonstration Boards or Evaluation Kits (9)
		Processor Module	Device Adapters	Transition Socket	Processor Module	Device Adapters	Transition Socket							
PIC17C756/ 756A	68L, 68CL	PCM17XA0	DVA17XL681							AC174007	AC164024		SW006010	DM173001
PIC17C756/ 756A	64PT	PCM17XA0	DVA17PO641	XLT64PT2						AC174008	AC164027		SW006010	DM173001
PIC17C762	84L	PCM17XA0	DVA17XL841	XLT80PT						AC174012			SW006010	DM173001
PIC17C762	80PT	PCM17XA0	DVA17PO801							AC174011			SW006010	DM173001
PIC17C766	84L, 84CL	PCM17XA0	DVA17XL841	XLT80PT						AC174012	AC164027		SW006010	DM173001
PIC17C766	80PT	PCM17XA0	DVA17PO801							AC174011			SW006010	DM173001
PIC18C242	28SP, 28JW	PCM18XA0	DVA16XP282	XLT80PT						AC164012	✓		SW006011	DM163022
PIC18C242	28SO	PCM18XA0	DVA16XP282	XLT28SO						AC164017			SW006011	DM163022
PIC18C252	28SP	PCM18XA0	DVA16XP282							AC164012	✓		SW006011	DM163022
PIC18C252	28JW	PCM18XA0	DVA16XP282	XLT28XP						AC164012			SW006011	DM163022
PIC18C252	28SO	PCM18XA0	DVA16XP282	XLT28SO						AC164017			SW006011	DM163022
PIC18C442	40P, 40JW	PCM18XA0	DVA16XP401							AC164012	✓		SW006011	DM163022
PIC18C442	44L	PCM18XA0	DVA16XL441							AC164013			SW006011	DM163022
PIC18C442	44PT	PCM18XA0	DVA16PO441	XLT44PT						AC164020			SW006011	DM163022
PIC18C452	40P, 40JW	PCM18XA0	DVA16XP401							AC164012	✓		SW006011	DM163022
PIC18C452	44L	PCM18XA0	DVA16XL441							AC164013			SW006011	DM163022
PIC18C452	44PT	PCM18XA0	DVA16PO441	XLT44PT						AC164020			SW006011	DM163022
PIC18C601	68L									AC174007		✓	SW006011	DM163006
PIC18C601	64PT									AC174008		✓	SW006011	DM163006
PIC18C801	80PT									AC174011		✓	SW006011	DM163006
PIC18C801	84L									AC174012		✓	SW006011	DM163007
PIC18C658	68L	PCM18XB0	DVA18XL680	XLT64PT2						AC174007	✓(8)		SW006011	DM163007
PIC18C658	64PT	PCM18XB0	DVA18PO640							AC174008			SW006011	DM163007
PIC18C858	84L	PCM18XB0	DVA18XL840	XLT80PT						AC174012			SW006011	DM163022
PIC18C858	80PT	PCM18XB0	DVA18PO800							AC174011			SW006011	DM163022
PIC18F242	28SP	PCM18XH0	DVA16XP282	XLT28SO						AC164012	✓		SW006011	DM163022
PIC18F242	28SO	PCM18XH0	DVA16XP282	XLT28SO						AC164017			SW006011	DM163022
PIC18F248	28SP	PCM18XD1	DVA16XP282	XLT28SO						AC164012	✓		SW006011	DM163022
PIC18F248	28SO	PCM18XD1	DVA16XP282	XLT28SO						AC164017			SW006011	DM163022
PIC18F252	28SP	PCM18XH0	DVA16XP282	XLT28SO						AC164012	✓		SW006011	DM163022
PIC18F252	28SO	PCM18XH0	DVA16XP282	XLT28SO						AC164017			SW006011	DM163022
PIC18F258	28SP	PCM18XD1	DVA16XP282	XLT28SO						AC164012	✓		SW006011	DM163022, DM163011
PIC18F258	28SO	PCM18XD1	DVA16XP282	XLT28SO						AC164017			SW006011	DM163022, DM163011
PIC18F442	40P	PCM18XH0	DVA16XP401							AC164012	✓		SW006011	DM163022
PIC18F442	44L	PCM18XH0	DVA16XL441							AC164013			SW006011	DM163022
PIC18F442	44PT	PCM18XH0	DVA16PO441	XLT44PT						AC164020			SW006011	DM163022
PIC18F448	40P	PCM18XD1	DVA16XP401							AC164012	✓		SW006011	DM163022
PIC18F448	44L	PCM18XD1	DVA16XL441							AC164013			SW006011	DM163022
PIC18F448	44PT	PCM18XD1	DVA16PO441	XLT44PT						AC164020			SW006011	DM163022

Cross Reference

MPLAB® ICE 2000 and MPLAB® ICE 4000 Emulator Systems, PRO MATE® II Programmer Socket Modules, MPLAB® In-Circuit Debugger, Software Tools, Programmers and Demonstration Boards

			MPLAB® ICE 2000 System (1)				MPLAB® ICE 4000 System (2)				PRO MATE® II Socket Module (3,4)				PICSTART® Plus (5)		MPLAB® ICD 2 (6, 7)		MPLAB® CXX Compiler		Demonstration Boards or Evaluation Kits (8)	
Part Number	Lead Count/ Pkg Type	Processor Module	Device Adapters	Transition Socket	Processor Module	Device Adapters	Transition Socket	Processor Module	Device Adapters	Transition Socket	Processor Module	Device Adapters	Transition Socket	PRO MATE® II Socket Module (3,4)	PICSTART® Plus (5)	MPLAB® ICD 2 (6, 7)	MPLAB® CXX Compiler	Demonstration Boards or Evaluation Kits (8)				
PIC18F452	40P	PCM18XH0	DVA16XP401		PMF18WC0*	DAF18-2*	ACICE0206		ACICE0206	AC164012	SW006011	✓	✓	AC164012	✓	✓	SW006011	DM163022				
PIC18F452	44L	PCM18XH0	DVA16XL441		PMF18WC0*	DAF18-3*	TBD		TBD	AC164013	SW006011	✓	✓	AC164013	✓	✓	SW006011					
PIC18F452	44PT	PCM18XH0	DVA16PQ441	XLT44PT	PMF18WC0*	DAF18-3*	XLT44PT		XLT44PT	AC164020	SW006011	✓	✓	AC164020	✓	✓	SW006011	DM163022, DM163011				
PIC18F458	40P	PCM18XD1	DVA16XP401							AC164012	SW006011	✓	✓	AC164012	✓	✓	SW006011					
PIC18F458	44L	PCM18XD1	DVA16XL441							AC164013	SW006011	✓	✓	AC164013	✓	✓	SW006011					
PIC18F458	44PT	PCM18XD1	DVA16PQ441	XLT44PT						AC164020	SW006011	✓	✓	AC164020	✓	✓	SW006011	DM163022, DM163011				
PIC18F1220	18P	PCM18XJ0	DVA18XP180		PMF18WD0*	DAF18-2*	ACICE0202		ACICE0202	AC164010	SW006011	✓	✓	AC164010	✓	✓	SW006011	DM163014				
PIC18F1220	18SO	PCM18XJ0	DVA18XP180	XLT18SO	PMF18WD0*	DAF18-2*	XLT18SO		XLT18SO	AC164010	SW006011	✓	✓	AC164010	✓	✓	SW006011					
PIC18F1220	20SS	PCM18XJ0	DVA18XP180	XLT20SS	PMF18WD0*	DAF18-2*	XLT20SS		XLT20SS	AC164018	SW006011	✓	✓	AC164018	✓	✓	SW006011					
PIC18F1220	28ML	PCM18XJ0	DVA18XP180	XLT28QFN2*	PMF18WD0*	DAF18-2*	XLT28QFN2*		XLT28QFN2*	AC164033	SW006011	✓	✓	AC164033	✓	✓	SW006011					
PIC18F1320	18P	PCM18XJ0	DVA18XP180		PMF18WD0*	DAF18-2*	ACICE0202		ACICE0202	AC164010	SW006011	✓	✓	AC164010	✓	✓	SW006011	DM163014				
PIC18F1320	18SO	PCM18XJ0	DVA18XP180	XLT18SO	PMF18WD0*	DAF18-2*	XLT18SO		XLT18SO	AC164010	SW006011	✓	✓	AC164010	✓	✓	SW006011					
PIC18F1320	20SS	PCM18XJ0	DVA18XP180	XLT20SS	PMF18WD0*	DAF18-2*	XLT20SS		XLT20SS	AC164018	SW006011	✓	✓	AC164018	✓	✓	SW006011					
PIC18F1320	28ML	PCM18XJ0	DVA18XP180	XLT28QFN2*	PMF18WD0*	DAF18-2*	XLT28QFN2*		XLT28QFN2*	AC164033	SW006011	✓	✓	AC164033	✓	✓	SW006011					
PIC18F2220	28SP	PCM18XH0	DVA18XP280		PMF18WC0*	DAF18-2*	ACICE0204		ACICE0204	AC164012	SW006011	✓	✓	AC164012	✓	✓	SW006011					
PIC18F2220	28SO	PCM18XH0	DVA18XP280	XLT28SO	PMF18WC0*	DAF18-2*	XLT28SO		XLT28SO	AC164017	SW006011	✓	✓	AC164017	✓	✓	SW006011					
PIC18F2320	28SP	PCM18XH0	DVA18XP280		PMF18WC0*	DAF18-2*	ACICE0204		ACICE0204	AC164012	SW006011	✓	✓	AC164012	✓	✓	SW006011					
PIC18F2320	28SO	PCM18XH0	DVA18XP280	XLT28SO	PMF18WC0*	DAF18-2*	XLT28SO		XLT28SO	AC164017	SW006011	✓	✓	AC164017	✓	✓	SW006011					
PIC18F2439	28P									AC164012	SW006011	✓	✓	AC164012	✓	✓	SW006011					
PIC18F2439	28SO									AC164017	SW006011	✓	✓	AC164017	✓	✓	SW006011					
PIC18F2539	28P									AC164012	SW006011	✓	✓	AC164012	✓	✓	SW006011	DM183010				
PIC18F2539	28SO									AC164017	SW006011	✓	✓	AC164017	✓	✓	SW006011					
PIC18F4220	40P	PCM18XH0	DVA18XP400		PMF18WC0*	DAF18-2*	ACICE0206		ACICE0206	AC164012	SW006011	✓	✓	AC164012	✓	✓	SW006011					
PIC18F4220	44ML	PCM18XH0	DVA18XP400	XLT44QFN*	PMF18WC0*	DAF18-3*	XLT44QFN*		XLT44QFN*	AC164034*	SW006011	✓	✓	AC164034*	✓	✓	SW006011					
PIC18F4220	44PT	PCM18XH0	DVA18PQ440	XLT44PT	PMF18WC0*	DAF18-3*	XLT44PT		XLT44PT	AC164034*	SW006011	✓	✓	AC164034*	✓	✓	SW006011					
PIC18F4320	40P	PCM18XH0	DVA18XP400		PMF18WC0*	DAF18-2*	ACICE0206		ACICE0206	AC164012	SW006011	✓	✓	AC164012	✓	✓	SW006011					
PIC18F4320	44ML	PCM18XH0	DVA18XP400	XLT44QFN*	PMF18WC0*	DAF18-3*	XLT44QFN*		XLT44QFN*	AC164034*	SW006011	✓	✓	AC164034*	✓	✓	SW006011					
PIC18F4320	44PT	PCM18XH0	DVA18PQ440	XLT44PT	PMF18WC0*	DAF18-3*	XLT44PT		XLT44PT	AC164034*	SW006011	✓	✓	AC164034*	✓	✓	SW006011					
PIC18F4439	40P									AC164012	SW006011	✓	✓	AC164012	✓	✓	SW006011					
PIC18F4439	44ML									AC164034*	SW006011	✓	✓	AC164034*	✓	✓	SW006011					
PIC18F4439	44PT									AC164034*	SW006011	✓	✓	AC164034*	✓	✓	SW006011					
PIC18F4539	40P									AC164012	SW006011	✓	✓	AC164012	✓	✓	SW006011					
PIC18F4539	44ML									AC164034*	SW006011	✓	✓	AC164034*	✓	✓	SW006011					
PIC18F4539	44PT									AC164034*	SW006011	✓	✓	AC164034*	✓	✓	SW006011					
PIC18F6520	64PT	PCM18XE1	DVA18PQ640	XLT64PT2	PMF18WA0	DAF18-1	XLT64PT2		XLT64PT2	AC174008	SW006011	✓	✓	AC174008	✓	✓	SW006011	DM183020				
PIC18F6525	64PT	PCM18XK0*	DVA18PQ802*	XLT64PT2	PMF18WE0*	DAF18-1	XLT64PT2		XLT64PT2	AC174008	SW006011	✓	✓	AC174008	✓	✓	SW006011					

Development Tools Ordering Guide

MPLAB® ICE 2000 and MPLAB® ICE 4000 Emulator Systems, PRO MATE® II Programmer Socket Modules, MPLAB® In-Circuit Debugger, Software Tools, Programmers and Demonstration Boards

		MPLAB® ICE 2000 System (1)				MPLAB® ICE 4000 System (2)				PICSTART® Plus (5)	MPLAB® ICD 2 (6, 7)	MPLAB® CXX Compiler	Demonstration Boards or Evaluation Kits (9)	
Part Number	Lead Count/ Pkg Type	Processor Module	Device Adapters	Transition Socket	Processor Module	Device Adapters	Transition Socket	Processor Module	Device Adapters	Transition Socket	PRO MATE® II Socket Module (3,4)			
PIC18F6585	68L	PCM18XK0*	DVA18XL681*	XLT64PT2	PMF18WE0*	DAF18-1	TBD	PMF18WE0*	DAF18-1	TBD	AC174007	✓	SW006011	
PIC18F6585	64PT	PCM18XK0*	DVA18PQ802*	XLT64PT2	PMF18WE0*	DAF18-1	XLT64PT2	PMF18WE0*	DAF18-1	XLT64PT2	AC174008	✓	SW006011	
PIC18F6620	64PT	PCM18XE1	DVA18PQ640	XLT64PT2	PMF18WE0*	DAF18-1	XLT64PT2	PMF18WE0*	DAF18-1	XLT64PT2	AC174008	✓	SW006011	DM183020
PIC18F6621	64PT	PCM18XK0*	DVA18PQ802*	XLT64PT2	PMF18WE0*	DAF18-1	XLT64PT2	PMF18WE0*	DAF18-1	XLT64PT2	AC174008	✓	SW006011	
PIC18F6680	68L	PCM18XK0*	DVA18XL681*	XLT64PT2	PMF18WE0*	DAF18-1	TBD	PMF18WE0*	DAF18-1	TBD	AC174007	✓	SW006011	
PIC18F6680	64PT	PCM18XK0*	DVA18PQ802*	XLT64PT2	PMF18WE0*	DAF18-1	XLT64PT2	PMF18WE0*	DAF18-1	XLT64PT2	AC174008	✓	SW006011	
PIC18F6720	64PT	PCM18XE1	DVA18PQ640	XLT64PT2	PMF18WE0*	DAF18-1	XLT64PT2	PMF18WE0*	DAF18-1	XLT64PT2	AC174008	✓	SW006011	DM183020
PIC18F8520	80PT	PCM18XE1	DVA18PQ800	XLT80PT	PMF18WE0*	DAF18-1	XLT80PT	PMF18WE0*	DAF18-1	XLT80PT	AC174011	✓	SW006011	DM183020
PIC18F8525	80PT	PCM18XK0*	DVA18PQ802*	XLT80PT	PMF18WE0*	DAF18-1	XLT80PT	PMF18WE0*	DAF18-1	XLT80PT	AC174011	✓	SW006011	
PIC18F8585	80PT	PCM18XK0*	DVA18PQ802*	XLT80PT	PMF18WE0*	DAF18-1	XLT80PT	PMF18WE0*	DAF18-1	XLT80PT	AC174011	✓	SW006011	
PIC18F8620	80PT	PCM18XE1	DVA18PQ800	XLT80PT	PMF18WE0*	DAF18-1	XLT80PT	PMF18WE0*	DAF18-1	XLT80PT	AC174011	✓	SW006011	DM183020
PIC18F8621	80PT	PCM18XK0*	DVA18PQ802*	XLT80PT	PMF18WE0*	DAF18-1	XLT80PT	PMF18WE0*	DAF18-1	XLT80PT	AC174011	✓	SW006011	
PIC18F8680	80PT	PCM18XK0*	DVA18PQ802*	XLT80PT	PMF18WE0*	DAF18-1	XLT80PT	PMF18WE0*	DAF18-1	XLT80PT	AC174011	✓	SW006011	
PIC18F8720	80PT	PCM18XE1	DVA18PQ800	XLT80PT	PMF18WE0*	DAF18-1	XLT80PT	PMF18WE0*	DAF18-1	XLT80PT	AC174011	✓	SW006011	DM183020
rfPIC™ Microcontroller Development Tools														
rfPIC12C509A	18SO	PCM16XA0	DVA12XP080	XLT18SO							AC124002	✓		
rfPIC12C509A	20SS	PCM16XA0	DVA12XP080	XLT20SS							AC124002			DV164102* AC164101* AC164103*
rfPIC12F675F	20SS	PCM12XB0	DVA12XP081	XLT20SS							AC124002			
rfPIC12F675H	20SS	PCM12XB0	DVA12XP081	XLT20SS							AC124002			
rfPIC12F675K	20SS	PCM12XB0	DVA12XP081	XLT20SS							AC124002			DV164102* AC164102* AC164104*
dsPIC® Microcontroller Development Tools														
dsPIC30F2010	28SO				PMF30XA1*	DAF30XP280*		PMF30XA1*	DAF30XP280*		AC30F004*	✓	SW006012*	
dsPIC30F2010	28SP				PMF30XA1*	DAF30XP280*		PMF30XA1*	DAF30XP280*		AC30F004*	✓	SW006012*	
dsPIC30F2011	18SO				PMF30XA1*	DAF30XP280*		PMF30XA1*	DAF30XP280*		AC30F005*	✓	SW006012*	
dsPIC30F2011	18SP				PMF30XA1*	DAF30XP280*		PMF30XA1*	DAF30XP280*		AC30F005*	✓	SW006012*	
dsPIC30F2012	28SO				PMF30XA1*	DAF30XP280*		PMF30XA1*	DAF30XP280*		AC30F004*	✓	SW006012*	
dsPIC30F2012	28SP				PMF30SA1*	DAF30XP280*		PMF30SA1*	DAF30XP280*		AC30F004*	✓	SW006012*	
dsPIC30F3010	28SO				PMF30XA1*	DAF30XP280*		PMF30XA1*	DAF30XP280*		AC30F004*	✓	SW006012*	
dsPIC30F3010	28SP				PMF30XA1*	DAF30XP280*		PMF30XA1*	DAF30XP280*		AC30F004*	✓	SW006012*	
dsPIC30F3011	40P				PMF30XA1*	DAF30XP400*		PMF30XA1*	DAF30XP400*		AC30F003*	✓	SW006012*	
dsPIC30F3011	44PT				PMF30XA1*	DAF30PT440*		PMF30XA1*	DAF30PT440*		AC30F006*	✓	SW006012*	
dsPIC30F3012	18SO				PMF30XA1*	DAF30XP280*		PMF30XA1*	DAF30XP280*		AC30F005*	✓	SW006012*	
dsPIC30F3012	18P				PMF30XA1*	DAF30XP280*		PMF30XA1*	DAF30XP280*		AC30F005*	✓	SW006012*	
dsPIC30F3013	28SO				PMF30XA1*	DAF30XP280*		PMF30XA1*	DAF30XP280*		AC30F004*	✓	SW006012*	
dsPIC30F3013	28SP				PMF30XA1*	DAF30XP280*		PMF30XA1*	DAF30XP280*		AC30F004*	✓	SW006012*	
dsPIC30F3014	40P				PMF30XA1*	DAF30XP400*		PMF30XA1*	DAF30XP400*		AC30F003*	✓	SW006012*	
dsPIC30F3014	44PT				PMF30XA1*	DAF30PT440*		PMF30XA1*	DAF30PT440*		AC30F006*	✓	SW006012*	

MPLAB® ICE 2000 and MPLAB® ICE 4000 Emulator Systems, PRO MATE® II Programmer Socket Modules, MPLAB® In-Circuit Debugger, Software Tools, Programmers and Demonstration Boards

Part Number	MPLAB® ICE 2000 System (1)				MPLAB® ICE 4000 System (2)				PICSTART® Plus (5)	MPLAB® ICD 2 (6, 7)	MPLAB® CXX Compiler	Demonstration Boards or Evaluation Kits (9)
	Lead Count/ Pkg Type	Processor Module	Device Adapters	Transition Socket	Processor Module	Device Adapters	Transition Socket	PRO MATE® II Socket Module (3,4)				
dsPIC30F4011	40P				PMF30XA1*	DAF30XP400*		AC30F003*		✓	SW006012*	
dsPIC30F4011	44PT				PMF30XA1*	DAF30PT440*		AC30F006*		✓	SW006012*	
dsPIC30F4012	28SO				PMF30XA1*	DAF30XP280*		AC30F004*		✓	SW006012*	
dsPIC30F4012	28SP				PMF30XA1*	DAF30XP280*		AC30F004*		✓	SW006012*	
dsPIC30F4013	40P				PMF30XA1*	DAF30XP400*		AC30F003*		✓	SW006012*	
dsPIC30F4013	44PT				PMF30XA1*	DAF30PT440*		AC30F006*		✓	SW006012*	
dsPIC30F5011	64PT				PMF30XA1*	DAF30PT640*		AC30F002*		✓	SW006012*	
dsPIC30F5013	80PT				PMF30XA1*	DAF30PT800*		AC30F001*			SW006012*	DM300014* DM300016* DM300004-1* DM300004-2*
dsPIC30F5015	64PT				PMF30XA1*	DAF30PT640*		AC30F002*		✓	SW006012*	
dsPIC30F6010	80PT				PMF30XA1*	DAF30PT800*		AC30F001*		✓	SW006012*	DM300020* DM300021* DM300022*
dsPIC30F6011	64PT				PMF30XA1*	DAF30PT640*		AC30F002*		✓	SW006012*	
dsPIC30F6012	64PT				PMF30XA1*	DAF30PT640*		AC30F002*		✓	SW006012*	DM300016*
dsPIC30F6013	80PT				PMF30XA1*	DAF30PT800*		AC30F001*		✓	SW006012*	DM300014* DM300016* DM300004-1* DM300004-2*
dsPIC30F6014	80PT				PMF30XA1*	DAF30PT800*		AC30F001*		✓	SW006012*	DM300014* DM300016* DM300004-1* DM300004-2*

NOTES 1: ICE 2000 pod available separately. (ICE2000)

2: ICE 4000 pod available separately. (ICE4000)

3: PRO MATE® II Programmer unit available separately. (DV007003)

4: Optional ICSP™ In-Circuit Serial Programming™ Socket for PRO MATE® II available separately. (AC004004)

5: PICSTART® Plus (DV003001)

6: MPLAB® ICE 2 In-Circuit Debugger. Configurations are:

(DV164005) ICD 2 module, USB cable and ICD cable.

(DV164006) ICD 2 module, USB cable, ICD cable, serial cable, PICDEM™ 2 Plus and power supply.

(DV164007) ICD 2 module, USB cable, ICD cable, serial cable and power supply.

7: MPLAB® ICE supporting PIC16F87X and 87XA under MPLAB® 5.70 only. Configurations are:

(DV164001) ICD module, ICD demo, ICD header, ICD cable and serial cable.

(DV164002) ICD module, ICD cable and serial cable.

(DV164003) ICD module, ICD demo board, ICD header, ICD cable, serial cable and power supply.

(AC162049) ICD 2 Universal Programming Module.

(AC162051) ICD or ICD 2 28/40 PDIP Header Interface Board.

8: Custom adapter required; not available from Microchip. See "Readme" for PICSTART® Plus.

Development Tools Ordering Guide

Part Number	Description
Demonstration Boards and Evaluation Kits	
PICmicro® Demonstration Kits	
DM143001	PICDEM™ 14A Demo Board for PIC14C000
DM163001	PICDEM™ 1 Demo Board for PIC16C5X, 55X, 62X, CE62X, 71, 710, 711, 715, 770, 771, 83, 84, and PIC17C42, 43, 44
DM163003	PICDEM™ 3 Demo Board for PIC16C923, 924, 925, 926
DM163006	PICDEM™ 18R Demo Board for PIC18C601/801
DM163014	PICDEM™ 4 Demo Board for PIC12F629, 675, PIC18F630, 676, 684, 627A, 648A, 818, 819, 87, 88, 1220, 1320
DM163022	PICDEM™ 2 Plus Demo Board for PIC16C62, 63, 64, 65, 66, 67, 72, 73, 74, 76, 77, 87X, 773, 774 and PIC18CXX2, 642, 662, and PIC18FXXX
PICmicro® Demonstration Kits (continued)	
DM173001	PICDEM™ 17 Demo Board for PIC17CXX
DM183010	PIC18F2539 Motor Control Demo Kit
DM183020	PIC18FXX20 64/80L TQFP Demo Board for PIC18F6620, 6720, 8620, 8720, 8520, 8520
DV164101	PICkit™ 1 8/14P Flash Development Kit for PIC12F629, 675 and PIC16F630, 676
DV164102*	rPIC™ Development Kit 1
AC164101*	rPIC™ Transmitter Module (433.92 MHz)
AC164102*	rPIC™ Transmitter Module (315 MHz)
AC164103*	rPIC™ Receiver Module (433.92 MHz)
AC164104*	rPIC™ Receiver Module (315 MHz)
Connectivity Demonstration Kits	
DM163004	PICDEM.net™ TCP/IP Demo Board
DM163005	PICDEM™ LIN Demo Board for PIC16C432/433 LIN Bus
DM163007*	PICDEM™ CAN-LIN 1 Demo Board
DM163008	MCP2120/2150 Developer's Kit for IR Communication
DM163010	PICDEM™ USB Demo Board for PIC16C7X5
DM163011*	PICDEM™ CAN-LIN 2 Demo Board
DV250501	MCP250XX CAN Developer's Kit
DV251001	MCP2510 CAN Developer's Kit
Mixed Signal Control Demonstration Kits	
DM163012	PICDEM™ MSC 1 Mixed Signal Controller Demo Board for PIC16C781/782
AC163001	PICDEM™ MSC 1 Voltage Boost Demo Board; requires DM163012
AC163002	PICDEM™ MSC 1 High Power IR Demo Board; requires DM163012
AC163003	PICDEM™ MSC 1 Delta Sigma Demo Board; requires DM163012
AC163004	PICDEM™ MSC 1 Flow Rate Sensor Demo Board; requires DM163012
dsPIC® 16-bit MCU/ DSP Demonstration Kits	
DM300014*	dsPICDEM™ 1.1 General Purpose Demo Board
DM300016*	dsPICDEM™ Starter Demo Board
DM300020*	dsPICDEM™ MC1 Motor Control Development Board
DM300021*	dsPICDEM™ MC1H 3-Phase High Voltage Power Module
DM300022*	dsPICDEM™ MC1L 3-Phase Low Voltage Power Module
DM300004-1*	dsPICDEM.net™ 1 FCC/JATE PSTN Support, Ethernet NIC Demo Board
DM300004-2*	dsPICDEM.net™ 2 CTR-21 PSTN Support, Ethernet NIC Demo Board
* Contact Microchip web site at www.microchip.com for availability.	

Demonstration Boards and Evaluation Kits

Part Number	Description
dsPIC® 16-bit MCU/DSP Software Tools	
SW300001*	Visual Filter Designer
SW300002*	dsPIC® V.22/V.22bis Soft Modem Library
SW300003, 04, 05*	dsPIC® V.32 Soft Modem Library
SW300006*	dsPIC® V.22/V.22bis Soft Modem Library by Vocal Technology
SW300010, 11, 12*	dsPIC® Speech Recognition
SW300020*	dsPIC® 30 Math Library: Double-Precision Floating Point Routines
SW300021*	dsPIC® 30 Peripheral Library: Peripheral Initialization and Control Routines
SW300022*	dsPIC® 30 DSP Library: Data Signal Processing Library Suite (FFT, Filters)
SW300023*	dsPICworks™ Visual Algorithm Analyzer: Data Analyzer and Converter Tool
SW300030*	dsPIC® Scheduler: Multi-tasking, Preemptive Scheduler
SW300031*	CMX-RTX for dsPIC®: Fully Preemptive RTOS
SW300032*	CMX-Tiny+ for dsPIC®, Preemptive RTOS
* Contact Microchip web site at www.microchip.com for availability.	

PowerSmart® Systems

Model Name/ Part Number	Description
PS040*	PowerTool™ Development Software for PS401 and PS402 Applications
PS041	PS401 PowerInfo™ Board
PS042	PS401 PowerCal™ Board
PS070*	PowerMate™ Development Software for PS700 Applications
PS4160-3	3-cell Li-Ion Fuel Gauge
PS4160-4	4-cell Li-Ion Fuel Gauge
PS4160EV-3	3-cell Li-Ion Fuel Gauge with PS041 PowerInfo™ Board
PS4160EV-4	4-cell Li-Ion Fuel Gauge with PS041 PowerInfo™ Board
PS4200*	6-12 cell NiMH Fuel Gauge
PS4200EV*	6-12 Cell NiMH Fuel Gauge with PS041 PowerInfo™ Board
PS7051*	Single Cell Li-Ion Fuel Gauge with Protector
PS7052*	Two Cell Li-Ion Fuel Gauge with Protector
* Contact Microchip web site at www.microchip.com for availability.	

Memory Evaluation/Developer's Kits

SEEVAL™ Serial EEPROM Developer's Kit	DV243001	All serial EEPROMS, 24XX, 93XX, 25XX series
SEEVAL™ 32 Serial EEPROM Developer's Kit	DV243002*	All serial EEPROMS, 24XX, 93XX, 25XX series

* Contact Microchip Technology Inc. for availability date.

Development Tools Ordering Guide

KEELOQ® Evaluation Kits										
	HCS101	HCS200/201	HCS300/301/320	HCS360/361	HCS362	HCS365/370	HCS410/412	HCS473	HCS500/515	HCS512
KEELOQ Evaluation Kit	DM303002	DM303002	DM303002	DM303002	DM303002	DM303002	DM303005	DM303002	DM303002	DM303002
KEELOQ Transponder Evaluation Kit										
KEELOQ Evaluation Kit II	DM303006	DM303006	DM303006	DM303006	DM303006	DM303006	DM303006	DM303006	DM303006	DM303006
PRO MATE II Universal Programmer for SOIC	AC004002	AC004002	AC004002	AC004002	AC004002	AC004003	AC004002	AC004003	AC004003	AC164002
PRO MATE II Universal Programmer for DIP	AC004001	AC004001	AC004001	AC004001	AC004001	AC004007	AC004001	AC004007	AC004007	AC164001
PRO MATE II Universal Programmer for ICSP™	AC004004	AC004004	AC004004	AC004004	AC004004	AC004004	AC004004	AC004004	AC004004	AC004004

Analog Evaluation/Developer's Kits											
	MCP3001/02	MCP3004/08	MCP3201/02	MCP3204/08	MCP60X	MCP41XXX/ 42XXX	TC64X/64XB	TC650/51	TC652/53	TC74	TC3400/01/02/ 03/04/05
Analog Evaluation Kits											
Analog Evaluation Driver Board	DVMCPA	DVMCPA	DVMCPA	DVMCPA	–	DVMCPA					
Evaluation Board	DV3201A**	DV3204A**	DV3201A**	DV3204A**	–	DV42XXX**					
FilterLab™ Active Filter Design Tool					FilterLab*						
Thermal Management Tools											
Fan Controller Demo Board							TC642Demo	TC650Demo	TC652Demo		
Fan Controller Evaluation Kit							TC642EV			TC74Demo	
Serial Digital Thermal Sensor Demo Board											
Data Converter Tools											
Sigma-Delta A/D Family Demo Board											TC3400Demo
Sigma-Delta A/D Family Evaluation Kit											TC3400EV

* Available for download from Microchip Technology Inc.'s web site at www.microchip.com

** Must be ordered with DVMCPA.

RFID Evaluation/Developer's Kits										
	MCRF200	MCRF250	MCRF355	MCRF450/452						
125 kHz microID® Developer's Kit for MCRF200	DV103001	–	–	–						
125 kHz Anti-Collision microID Developer's Kit for MCRF250	–	DV103002	–	–						
13.56 MHz Anti-Collision microID Developer's Kit for MCRF355, 360, 450, 452	–	–	DV103003, DV103006	DV103006						
microID® Programmer Kit only for MCRF200, MCRF250	PG103001	PG103001	–	–						
microID® Programmer Kit only for MCRF355	–	–	PG103003	–						
Extra Card Pack for the 125 kHz microID® Developer's Kit for MCRF200	AC103001	–	–	–						
Extra Card Pack for the 125 kHz Anti-Collision microID Developer's Kit for MCRF250	–	AC103002	–	–						

Note the following details of the code protection feature on Microchip devices:

- Microchip products meet the specification contained in their particular Microchip Data Sheet.
- Microchip believes that its family of products is one of the most secure families of its kind on the market today, when used in the intended manner and under normal conditions.
- There are dishonest and possibly illegal methods used to breach the code protection feature. All of these methods, to our knowledge, require using the Microchip products in a manner outside the operating specifications contained in Microchip's Data Sheets. Most likely, the person doing so is engaged in theft of intellectual property.
- Microchip is willing to work with the customer who is concerned about the integrity of their code.
- Neither Microchip nor any other semiconductor manufacturer can guarantee the security of their code. Code protection does not mean that we are guaranteeing the product as "unbreakable."

Code protection is constantly evolving. We at Microchip are committed to continuously improving the code protection features of our products. Attempts to break microchip's code protection feature may be a violation of the Digital Millennium Copyright Act. If such acts allow unauthorized access to your software or other copyrighted work, you may have a right to sue for relief under that Act.

Information contained in this publication regarding device applications and the like is intended through suggestion only and may be superseded by updates. It is your responsibility to ensure that your application meets with your specifications. No representation or warranty is given and no liability is assumed by Microchip Technology Incorporated with respect to the accuracy or use of such information, or infringement of patents or other intellectual property rights arising from such use or otherwise. Use of Microchip's products as critical components in life support systems is not authorized except with express written approval by Microchip. No licenses are conveyed, implicitly or otherwise, under any intellectual property rights.

The graphics in this document are for illustration only. Microchip reserves the right to modify the contents of its development systems.

Trademarks

The Microchip name and logo, the Microchip logo, dsPIC, KEELoQ, MPLAB, PIC, PICmicro, PICSTART, PRO MATE and PowerSmart are registered trademarks of Microchip Technology Incorporated in the U.S.A. and other countries.

FilterLab, microID, MXDEV, MXLAB, PICMASTER, SEEVAL and The Embedded Control Solutions Company are registered trademarks of Microchip Technology Incorporated in the U.S.A.

Accuron, Application Maestro, dsPICDEM, dsPICDEM.net, ECONOMONITOR, FanSense, FlexROM, fuzzyLAB, In-Circuit Serial Programming, ICSP, ICEPIC, microPort, Migratable Memory, MPASM, MPLIB, MPLINK, MPSIM, PICC, PICkit, PICDEM, PICDEM.net, PowerCal, PowerInfo, PowerMate, PowerTool, rLAB, rPIC, Select Mode, SmartSensor, SmartShunt, SmartTel and Total Endurance are trademarks of Microchip Technology Incorporated in the U.S.A. and other countries.

Serialized Quick Turn Programming (SQTP) is a service mark of Microchip Technology Incorporated in the U.S.A.

All other trademarks mentioned herein are property of their respective companies.

© 2003, Microchip Technology Incorporated, Printed in the U.S.A., All Rights Reserved.

 Printed on recycled paper.

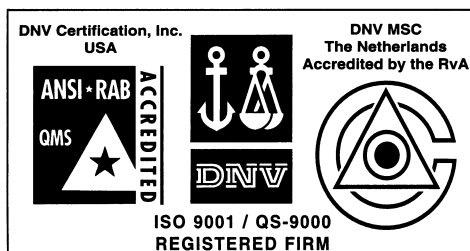

Microchip received QS-9000 quality system certification for its worldwide headquarters, design and wafer fabrication facilities in Chandler and Tempe, Arizona in July 1999 and Mountain View, California in March 2002. The Company's quality system processes and procedures are QS-9000 compliant for its PICmicro® 8-bit MCUs, KEELoQ® code hopping devices, Serial EEPROMs, microperipherals, non-volatile memory and analog products. In addition, Microchip's quality system for the design and manufacture of development systems is ISO 9001 certified.



WORLDWIDE SALES AND SERVICE

AMERICAS

Corporate Office

2355 West Chandler Blvd.
Chandler, AZ 85224-6199
Tel: 480-792-7200 Fax: 480-792-7277
Technical Support: 480-792-7627
Web Address: <http://www.microchip.com>

Atlanta

3780 Mansell Road, Suite 130
Alpharetta, GA 30022
Tel: 770-640-0034 Fax: 770-640-0307

Boston

2 Lan Drive, Suite 120
Westford, MA 01886
Tel: 978-692-3848 Fax: 978-692-3821

Chicago

333 Pierce Road, Suite 180
Itasca, IL 60143
Tel: 630-285-0071 Fax: 630-285-0075

Dallas

4570 Westgrove Drive, Suite 160
Addison, TX 75001
Tel: 972-818-7423 Fax: 972-818-2924

Detroit

Tri-Atria Office Building
32255 Northwestern Highway, Suite 190
Farmington Hills, MI 48334
Tel: 248-538-2250 Fax: 248-538-2260

Kokomo

2767 S. Albright Road
Kokomo, IN 46902
Tel: 765-864-8360 Fax: 765-864-8387

Los Angeles

18201 Von Karman, Suite 1090
Irvine, CA 92612
Tel: 949-263-1888 Fax: 949-263-1338

Phoenix

2355 West Chandler Blvd.
Chandler, AZ 85224-6199
Tel: 480-792-7966 Fax: 480-792-4338

San Jose

Microchip Technology Inc.
2107 North First Street, Suite 590
San Jose, CA 95131
Tel: 408-436-7950 Fax: 408-436-7955

Toronto

6285 Northam Drive, Suite 108
Mississauga, Ontario L4V 1X5, Canada
Tel: 905-673-0699 Fax: 905-673-6509

ASIA/PACIFIC

Australia

Microchip Technology Australia Pty Ltd
Marketing Support Division
Suite 22, 41 Rawson Street
Epping 2121, NSW
Australia
Tel: 61-2-9868-6733 Fax: 61-2-9868-6755

China - Beijing

Microchip Technology Consulting (Shanghai)
Co., Ltd., Beijing Liaison Office
Unit 915
Bei Hai Wan Tai Bldg.
No. 6 Chaoyangmen Beidajie
Beijing, 100027, No. China
Tel: 86-10-85282100 Fax: 86-10-85282104

China - Chengdu

Microchip Technology Consulting (Shanghai)
Co., Ltd., Chengdu Liaison Office
Rm. 2401-2402, 24th Floor,
Ming Xing Financial Tower
No. 88 TIDU Street
Chengdu 610016, China
Tel: 86-28-86766200 Fax: 86-28-86766599

China - Fuzhou

Microchip Technology Consulting (Shanghai)
Co., Ltd., Fuzhou Liaison Office
Unit 28F, World Trade Plaza
No. 71 Wusi Road
Fuzhou 350001, China
Tel: 86-591-7503506 Fax: 86-591-7503521

China - Hong Kong SAR

Microchip Technology Hongkong Ltd.
Unit 901-6, Tower 2, Metroplaza
223 Hing Fong Road
Kwai Fong, N.T., Hong Kong
Tel: 852-2401-1200 Fax: 852-2401-3431

China - Shanghai

Microchip Technology Consulting (Shanghai)
Co., Ltd.
Room 701, Bldg. B
Far East International Plaza
No. 317 Xian Xia Road
Shanghai, 200051
Tel: 86-21-6275-5700 Fax: 86-21-6275-5060

China - Shenzhen

Microchip Technology Consulting (Shanghai)
Co., Ltd., Shenzhen Liaison Office
Rm. 1812, 18/F, Building A, United Plaza
No. 5022 Binhe Road, Futian District
Shenzhen 518033, China
Tel: 86-755-82901380 Fax: 86-755-8295-1393

China - Qingdao

Rm. B505A, Fullhope Plaza,
No. 12 Hong Kong Central Rd.
Qingdao 266071, China
Tel: 86-532-5027355 Fax: 86-532-5027205

India

Microchip Technology Inc.
India Liaison Office
Marketing Support Division
Divyasree Chambers
1 Floor, Wing A (A3/A4)
No. 11, O'Shaugnessey Road
Bangalore, 560 025, India
Tel: 91-80-2290061 Fax: 91-80-2290062

Japan

Microchip Technology Japan K.K.
Benex S-1 6F
3-18-20, Shinyokohama
Kohoku-Ku, Yokohama-shi
Kanagawa, 222-0033, Japan
Tel: 81-45-471-6166 Fax: 81-45-471-6122

Korea

Microchip Technology Korea
168-1, Youngbo Bldg. 3 Floor
Samsung-Dong, Kangnam-Ku
Seoul, Korea 135-882
Tel: 82-2-554-7200 Fax: 82-2-558-5934

Singapore

Microchip Technology Singapore Pte Ltd.
200 Middle Road
#07-02 Prime Centre
Singapore, 188980
Tel: 65-6334-8870 Fax: 65-6334-8850

Taiwan

Microchip Technology (Barbados) Inc.,
Taiwan Branch
11F-3, No. 207
Tung Hua North Road
Taipei, 105, Taiwan
Tel: 886-2-2717-7175 Fax: 886-2-2545-0139

EUROPE

Austria

Microchip Technology Austria GmbH
Durisolstrasse 2
A-4600 Wels
Austria
Tel: 43-7242-2244-399
Fax: 43-7242-2244-393

Denmark

Microchip Technology Nordic ApS
Regus Business Centre
Lautrup hoj 1-3
Ballerup DK-2750 Denmark
Tel: 45-4420-9895 Fax: 45-4420-9910

France

Microchip Technology SARL
Parc d'Activite du Moulin de Massy
43 Rue du Saule Trapu
Batiment A - 1er Etage
91300 Massy, France
Tel: 33-1-69-53-63-20 Fax: 33-1-69-30-90-79

Germany

Microchip Technology GmbH
Steinheilstrasse 10
D-85737 Ismaning, Germany
Tel: 49-89-627-144-0
Fax: 49-89-627-144-44

Italy

Microchip Technology SRL
Via Quasimodo, 12
20025 Legnano (MI)
Milan, Italy
Tel: 39-0331-742611 Fax: 39-0331-466781

United Kingdom

Microchip Ltd.
505 Eskdale Road
Winnersh Triangle
Wokingham
Berkshire, England RG41 5TU
Tel: 44-118-921-5869 Fax: 44-118-921-5820

05/30/03