

Summary

The USB Evaluation Board is a circuit board for evaluating USB products from Firmware Factory. In any given evaluation, only a small proportion of the components will be fitted. For this reason it is supplied unpopulated and uses through-hole components for easy manual construction.

Compatible USB Products

The evaluation board is compatible with the following USB products from Firmware Factory:

- USB-232 asynchronous serial interface
- TEAleaf-USB security and authentication dongle
- expandIO-USB I/O expander
- USB-SPI synchronous serial interface
- USB-I2C synchronous serial interface
- USB-TakeOff managed power take-off, wakeup and charge controller
- USB-DAQ data logger
- USB-FileSys configuration and diagnostic module

To use the evaluation board with each of these products, please refer to each product's individual data sheet.

Features

The board provides for:

- 20-pin, 28-pin and 40-pin DIL devices
- Type B socket, suitable for standard USB cables
- Type A plug, suitable for USB extension cables
- 12MHz and 32kHz crystal oscillators
- RS232 line driver, 9-pin sockets in DTE and DCE configurations
- RS485 line driver
- Coin cell battery
- SPI serial memory
- 28-pin DIL host processor
- 3 active low LEDs
- 3 active high LEDs
- 3 jumpers
- Photodiode
- Thermistor
- Li-Ion charge controller
- Prototyping area



Firmware Factory Ltd
2 Marshall St, 3rd Floor
London W1F 9BB, UK
sales@firmwarefactory.com
support@firmwarefactory.com

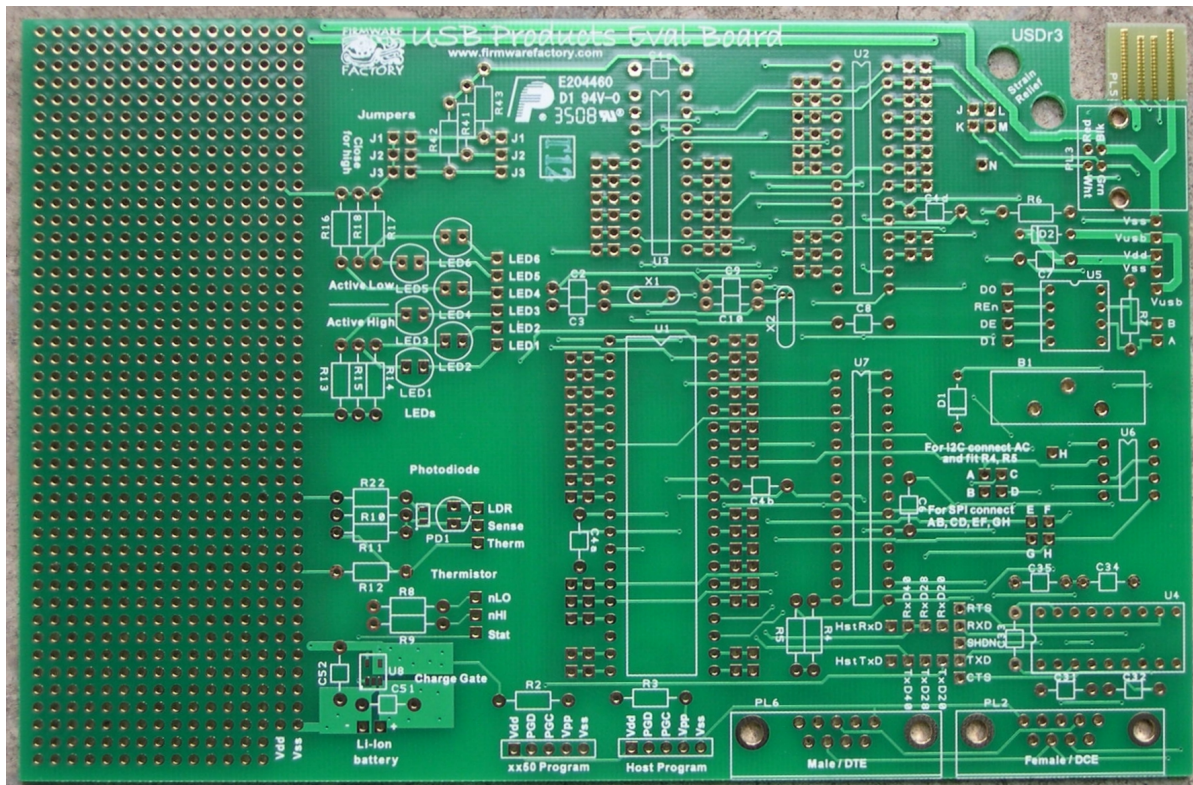

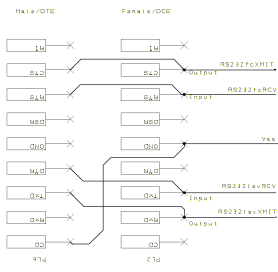

RS232 connectors

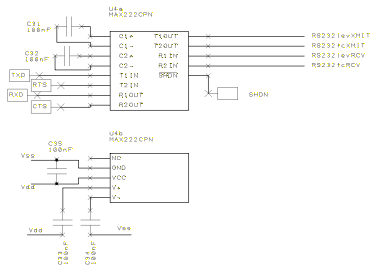

RS232 driver

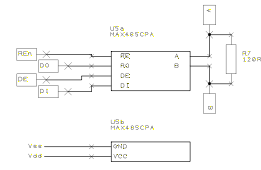

MAX485 driver

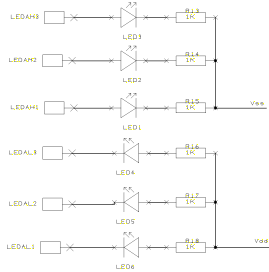

LEDs

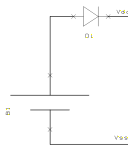

Coin cell

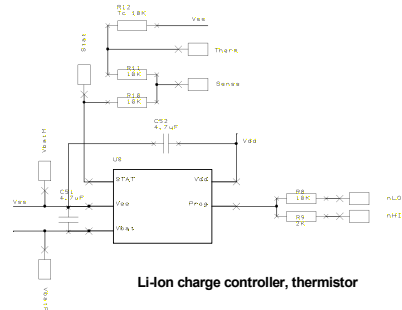

Li-Ion charge controller, thermistor

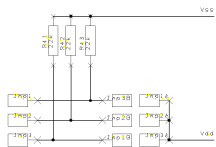

Jumpers

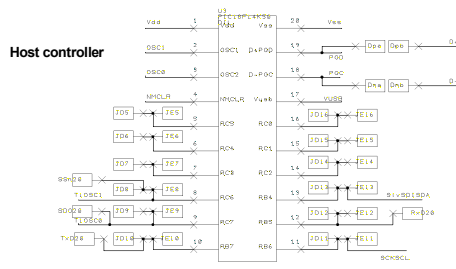

Host controller

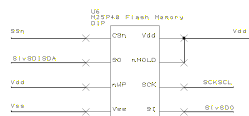

Serial Memory

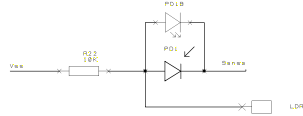

Photodiode

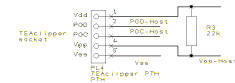

TEAclipper connector for host controller

