



- Wireless half duplex radio modem
- RS232 and RS485 serial interfaces
- RF power output 10mW
- Range up to 800m
- Radio baud rate up to 10kbps
- Serial baud rate up to 38.4kbp/s
- Housed in a tough ABS enclosure rated IP68
- European 869.400 to 869.650 MHz operation
- Requires no radio licence to operate
- Powered from 9 to 12Vdc
- Internal LED indication of power and communications
- Configurable with standard Hayes AT commands

Applications

- Wireless data logging
- CCTV control
- RS232 or RS485 serial cable replacement
- Machine to machine data communications



Description

The RF Solutions typhoon RF modem provides fast and reliable wireless data communications at an exceptionally competitive price. Whilst the RF modem is simple to use it is also highly adaptable and can be used in a wide variety of applications.

The RF modem is configurable as a 'transparent' wireless serial point-to-point link, reproducing the function of a half duplex serial cable. An addressed secured mode is also supported.

The RF modem can be configured to scan the radio link for activity and verify it is free before transmission thereby avoiding data collisions.

Supplied in a tough IP68 rated ABS enclosure, with an RS232 cable and antenna, the RF modem requires only a 9 to 12Vdc (1A maximum) power supply to function.

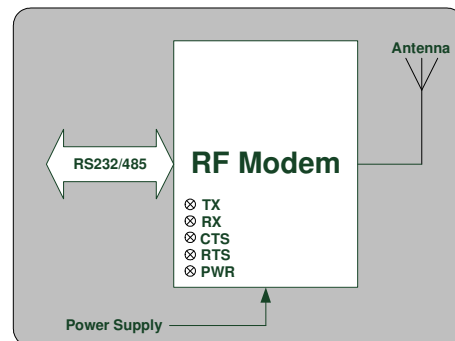



Contents

Technical Specification	3
1.1 Functional description	3
1.2 Functional Characteristics	3
1.2.1 General	3
1.2.2 Transmission.....	3
1.2.3 Reception.....	4
1.2.4 DC	4
1.3 Status LEDs	4
1.4 Power Supply	4
1.5 Host Interface.....	4
1.5.1 Serial Link Mode Selection	4
1.5.2 RS232 Serial Link	5
1.5.3 RS485 Serial Link	6
1.5.4 RS232/485 Slew Rate.....	6
1.6 Antenna	7
1.7 Temperature Range	7
1.8 Dimensions.....	7
Software Specification	8
2 Quick Setup Guide.....	8
Operating Modes	9
3 Hayes or 'AT' Mode	9
3.1.1 Standard Commands Description.....	9
3.2 Transparent Mode.....	10
3.3 Addressed Secured mode.....	10
Register Definitions	12
4 Radio.....	12
4.1 RS-232/485 Serial Link	12
4.2 Operation.....	13
4.3 Network Control	13
4.4 Radio Test Commands	14
Ordering Information.....	14



Technical Specification

1.1 Functional description

The RF modem is configurable as a 'transparent' wireless serial point-to-point link, reproducing the function of a half duplex serial cable. An addressed secured mode is also supported.

The RF modem can be configured to scan the radio link for activity and verify it is free before transmission thereby avoiding data collisions.

All parameters of the serial connection and radio modem are fully configurable in software using the Hayes AT command set. Commands are entered via the serial port from a host using communications software (for example a PC and Microsoft Windows HyperTerminal).

The configuration parameters are described in section 2.

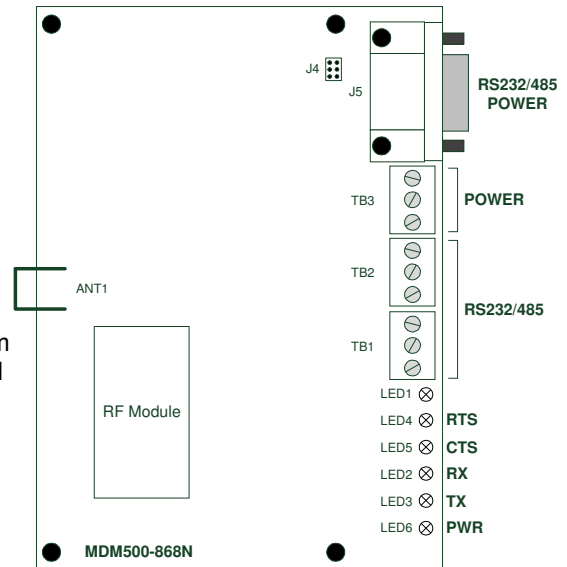

1.2 Functional Characteristics

1.2.1 General

Specification	Typical	Units
Frequency band	869.400 to 869.650	MHz
Modulation type	GFSK	-
Range (line-of-sight)	800	m
Conformity testing/standard	ETSI 300 220 ERC-REC 70-03	-

1.2.2 Transmission

Specification	Min	Typical	Max	Units
Output power ¹		7		dBm
Channel number ²	-	1	-	
Channel spacing	-	25	-	kHz
Radio data rate	-	-	10	kbps
Default Baud Rate	-	19,200	-	bps

¹ Power delivered into the antenna

² Centre frequency 869.525MHz (single-channel), first channel 869.4125MHz (multi-channel)

1.2.3 Reception

Specification	Min	Typical	Max	Units
Sensitivity for CER 10^{-3}	-98	-100	-102	dBm
Average CER	-	<math><1.10^{-6}</math>	-	-
Saturation for CER 10^{-3}	-	-	-10	dBm
Selectivity	-	36	-	dB

1.2.4 DC

Specification	Conditions	Min	Typical	Max	Units
Power supply	Ripple <math><50\text{mV}</math>	6.5V	12V	13.2	V
Current consumption	Transmit (27dBm/500mW)	30	33	36	mA
	Receive	27	30	33	mA

1.3 Status LEDs

The RF Modem has several LEDs that represent the status of the power supply and data and data transmissions as follows:

- TX – On when transmitting data over the air
- RX – On when receiving data over the air
- CTS – On with Clear To Send
- RTS – On with signal Ready To Send
- PWR – On when the power supply is healthy

1.4 Power Supply

The RF Modem is powered from a 9 to 12Vdc power supply which must be capable of providing current up to 1A. Connections are made using either TB3 or J5 as follows:

Pin	Connection
1	0V (ground)
2	0V (ground)
3	9 to 12Vdc, 1A max

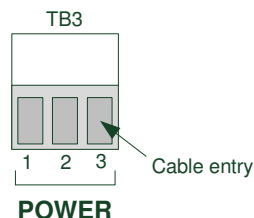

Pin	Connection
5	0V (ground)
9	9 to 12Vdc, 1A max

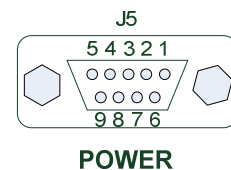

1.5 Host Interface

1.5.1 Serial Link Mode Selection

The RF modem can be interfaced to the host using either an RS232 or RS485 serial connection.

The mode is defined by a jumper link on pins 3-4 of J4.

Also, for RS485 operation the modems internal configuration

J4, 3-4	Operation
Fitted	RS232
Not Fitted	RS485

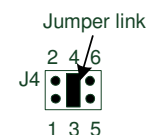

parameter for flow-control management must be set to "hardware - use CTS/RTS" (register S216=0).

1.5.2 RS232 Serial Link

RS232 connections are made using both TB1 and TB2 or by inserting a DB9 plug into J5:



Pin	Name	Description
1	GND	Ground, 0 Vdc
2	RTS	Request to send. From the host
3	TX	Transmit data. From the host

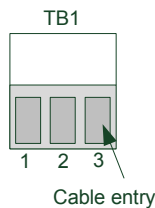

Pin	Name	Description
1	GND	Ground, 0 Vdc
2	RX	Receive data. To the host
3	CTS	Clear to send. To the host

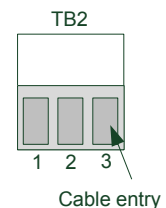

Pin	Name	Description	Additional Detail
2	RX	Receive data	To the host
3	TX	Transmit data	From the host
5	GND	Ground	0V
7	RTS	Request to send	From the host
8	CTS	Clear to send	To the host

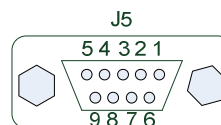

RS232

1.5.3 RS485 Serial Link

RS485 connections are made using both TB1 and TB2 or by inserting a DB9 serial cable into J5.



Plug this end into the host

Pin	Name	Description
1	GND	Ground, 0Vdc
2	TXB	Transmit data '-' From the host
3	TXA	Transmit data '+' From the host

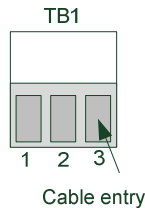

Pin	Name	Description
1	GND	Ground, 0Vdc
2	RXB	Receive data '-' To the host
3	RXA	Receive data '+' To the host

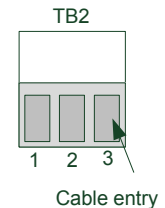

Pin	Name	Description	Additional Detail
2	RXB	Receive data '-'	To the host
8	RXA	Receive data '+'	To the host
5	GND	Ground	0V
3	TXA	Transmit data '+'	From the host
7	TXB	Transmit data '-'	From the host

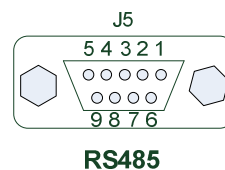

1.5.4 RS232/485 Slew Rate

When using the RF modem in a noisy environment it may be beneficial to limit the slew rate of the RS232 / RS485 interface to improve the noise immunity of the wired link.

The slew rate is set by a jumper on pins 5-6 of J4.

J4, 5-6	Operation
Fitted	Limit Slew Rate
Not Fitted	Normal Operation

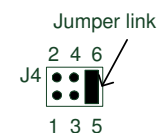



1.6 Antenna

The RF modem is supplied with an 868MHz ¼ wave whip antenna that has been carefully matched to the impedance of the RF modem's power amplifier³.

1.7 Temperature Range

Storage temperature: -40°C to +85°C

Operating temperature⁴: -10°C to +55°C

1.8 Dimensions

The RF modem is supplied in an IP68 rated enclosure having the following dimensions.

Enclosure dimensions⁵:
Height 144mm
Width 168mm
Depth 85mm

PCB dimensions: 125mm x 90mm x 1.6mm

³ It is the user's responsibility to ensure that an external antenna if added does not affect this products suitability to operate within the 868MHz ISM band to the relevant standards

⁴ Operation at maximum ratings for extended periods may affect the reliability of this product

⁵ All dimensions are approximate and exclude the antenna and any fixings



Software Specification

2 Quick Setup Guide

The RF modem is supplied with its registers set to their default values. Using the default settings it can quickly and easily be used, from a PC running the Microsoft Windows operating system, to establish a simple transparent point-to-point link.

The bundled MTC workbench software can be used by following the steps outlined below.

1. Install the MTC workbench software, supplied on the bundled CD onto your PC.
2. Connect your modem to the COM port of your PC using the supplied RS232 cable, apply power to the modem and load the MTC workbench software. The PWR and RTS LEDs will now be on.
3. When prompted to launch auto-configuration select 'No'.
4. In the *Settings* menu change the user level to advanced. From the *Modem* menu *Serial port configuration* and select 19,000bps.
5. From the *Tools* menu select *Terminal* and open a terminal window on the COM port connected to the modem. You can now type text into the terminal window, if the Port is opened (By pressing the 'Open Port' button) then the text data will be sent over the serial link to the modem, as shown opposite.
6. Repeat steps 1-5 using either another PC or a different COM port on the same PC.
7. If the configuration settings are the same for both modems then you should now be able to wirelessly send text from one COM port to the other.

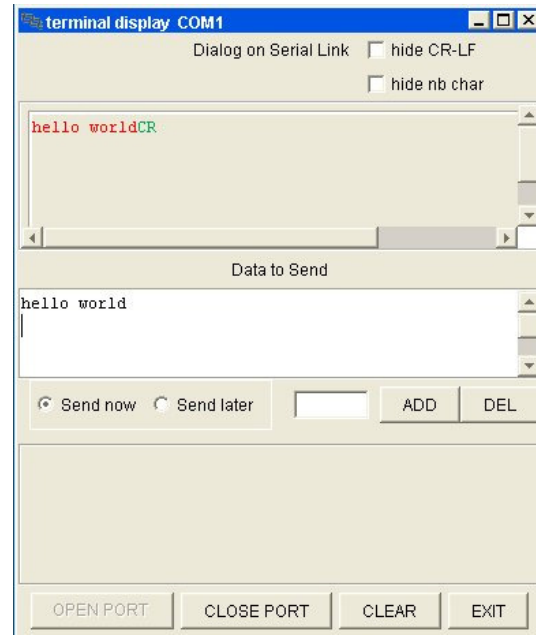

Notes

For full instructions on the use of the MTC workbench software please refer the manual provided on the CD bundled with the modems.

The modems configuration settings can be changed by double clicking on the modem name, 'B868-tiny' under the COM port in the *tree* window. Once you have changed the settings to those which you require they can be propagated through to the modems registers by clicking on the Apply button.

You can also change the configuration settings by entering AT commands into the terminal window in MTC workbench. Please refer to the sections for a description of the AT commands available.

Operating Modes

The RF modem is able to operate in several different modes which can be configured by setting the values of the appropriate special registers using AT commands.

3 Hayes or 'AT' Mode

The Hayes or 'AT' commands comply with the Hayes protocol used in PSTN modem standards. This 'AT' protocol or Hayes mode is used to program the modem parameters, based on the following principle:

- A data frame always begins with the 2 ASCII 'AT' characters, standing for 'ATtention'
- Commands are coded over one or several characters and may include additional data
- A command is always ended by a <CR> Carriage Return

A	T	Command	Additional command	...	<CR>
---	---	---------	--------------------	-----	------

Note 1: The delay between 2 characters of the same command must be less than 10 seconds

The only exception to this data-framing rule is the command to enter the enter AT-mode. In this case, only the escape code ('+++') by default) must be typed and followed by a silent time at least equal to the time out. <AT> and <CR> shall not be used.

Note 2: Register numbers and values used in the AT commands are in decimal format

Note 3: Generally a successful AT command will return 0 or OK and an unsuccessful command will return ERROR or E

3.1.1 Standard Commands Description

'+++' **Enter AT-mode**
This command gives an instant access to the modem parameter set-up (Hayes or AT-mode), whatever the actual operating mode in process might be. This command shall not be started with AT, but by a silent time duration whose parameter entering is defined in milliseconds in register S214.

Note: By activating the AT-mode, the modem inactivates radio reception

'ATO' **Exit AT-mode**
This command activates the operating mode as stored into register S220

'ATSn?' **Display value of register 'n'**
The modem operating parameters are stored in 'S' classified registers. 'S' registers are numbered from 0 to 512. Some parameters are standard for every Hayes type modems, other are specific to the RF modem (see section 2.9 for register descriptions). Operating parameters are stored in EEPROM memory and automatically set-up during modem reset and modem turn on

'ATSn=m' **Change value of register 'n' to 'm'**
Changed values of registers are automatically stored in the modem EEPROM memory

'AT/S' **Display values of significant registers**
All significant registers for the modem (radio configuration, serial configuration, operating mode,) are sent to the serial link, ready to be displayed by software like Windows HyperTerminal

'AT/V': **Display values of the modem software version**
Information concerning the version number and installation date is sent on the serial link

- 'ATR': Hayes registers reset to default values**
 This command allows the user to reset ALL the stored EEPROM registers to their default values (see section 2.9 for register descriptions)
- 'ATP': Switch to Stand-by mode**
 This command allows the user to switch to stand-by mode. The modem is in normal mode by default. The modem switches back to normal mode with a character reception from the serial link

3.2 Transparent Mode

This is the default operating mode.

Data is transferred transparently, without encapsulation, flow control or addressing. I.e. all data sent onto the serial port by the host is transmitted across the radio link by the RF modem and will be intercepted by any similarly configured modems.

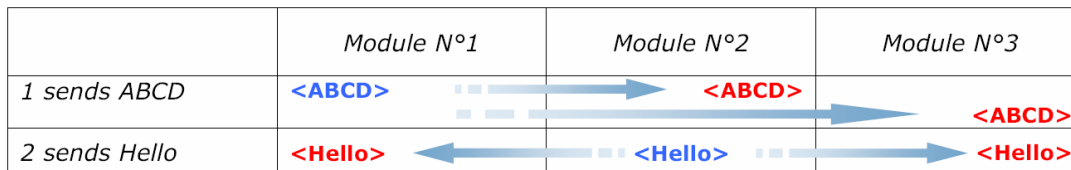

In this mode the RF modem appears as a wireless serial point-to-point link, reproducing the function of a half duplex serial cable⁶.

It can also be configured to scan the radio link for activity and verify it is free before transmission (listen before talk) thereby avoiding data collisions.

3.3 Addressed Secured mode

This is a simplified multipoint network protocol where a network of modems allows one modem to communicate with any other. All data transfers are encapsulated, addressed and have flow control (i.e. frames are checked using CRC then acknowledged).

This mode's purpose is to offer optimal radio link quality with secure data transfer and as such includes an address field so that it is possible to address a particular modem within a network. Key points are as follows:

- Data transmissions are fully «data verified»
- The modem acts as in transparent mode, adding frame encapsulation
- Each modem has an address
- Identification of a particular modem is enabled by adding that modems “address” at the beginning of each data frame
- Maximum number of modems per network = 255
- Maximum number of networks = 255

Example: "1=Hello" sends the data frame "Hello" to modem with address 1

- The modem with address '1' recognises the client transmitting modem by the number starting the data frame.

Example: "002=Hello" indicates that data frame "Hello" comes from Client No.2. o

- You can add one frame ending character: Carriage Return<CR>, after each received frame. This in order to distinguish each frame.

Example: "002=145<CR> 003=187<CR>" indicates data frame "145" comes from Client No.2, and data frame "187" comes from Client No.3.

- No server, each client can communicate with each other.
- Maximum of clients per network = 255, maximum of networks = 255.

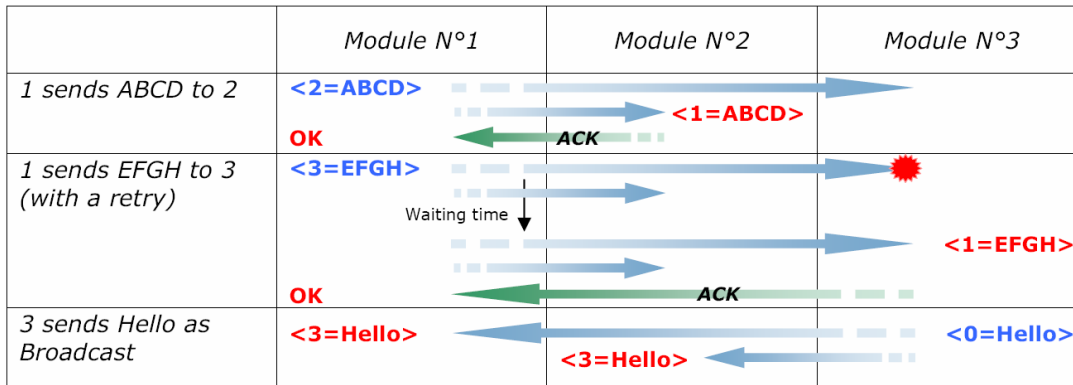

Collision or error

<in blue> : data sent

<in red> : data received

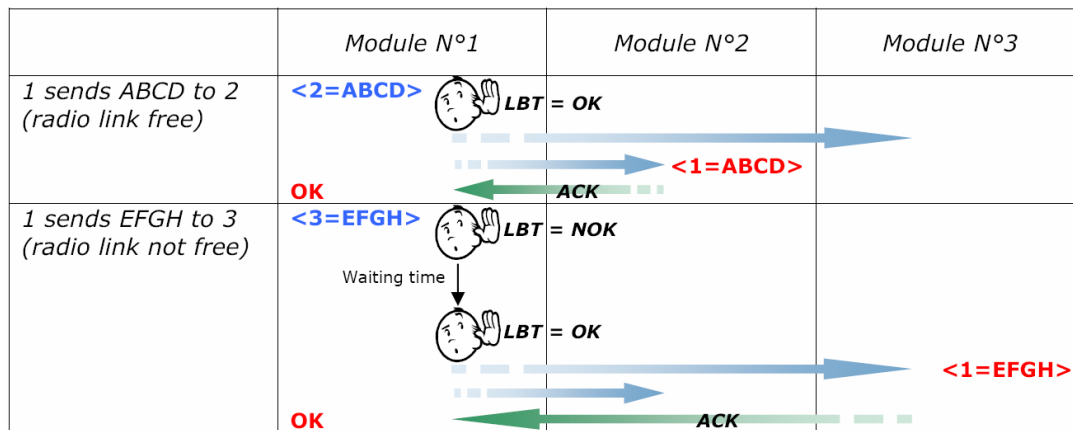

In this mode the RF modem can be configured to scan the radio link for activity and verify it is free before transmission (listen before talk) thereby avoiding data collisions.

Register Definitions

The RF modem offers several possible configurations using a set of parameters. The parameters are stored in registers and have default values. The values can be modified from the default or interrogated using Hayes commands.

The registers are implemented in EEPROM and can therefore be modified more than 10,000 times

The registers are listed below with default values shown in bold:

4 Radio

Access	Register	Name	Description
Radio			
R/W	S200	Channel	Used to indicate the current radio channel. As B868-tiny is a single channel module, the register is only present for compatibility with B868MC-Tiny units. Default : 0
R/W	S200	Carrier Length	Indicates the radio carrier length in milliseconds. This carrier is sent before each data frame and is used to Synchronize the receiver. Between 4 and 50 mS. Default : 15 ms

4.1 RS-232/485 Serial Link

Access	Register	Name	Description
Communications			
R/W	S210	Serial Speed	Serial Connection Baud Rate : <ul style="list-style-type: none"> • 1 1200 • 2 2400 • 3 4800 • 4 9600 • 5 19200 • 6 38400
R/W	S211	Data Bits	Serial Link Data Bits : <ul style="list-style-type: none"> • 7 bits • 8 bits (default)
R/W	S212	Parity	Serial Link Parity Type: <ul style="list-style-type: none"> • 1 None (default) • 2 Even • 3 Odd
R/W	S213	Stop Bits	Serial Link Stop Bits : <ul style="list-style-type: none"> • 1 bit (default) • 2 bits
R/W	S214	Serial Timeout	Indicates the value of the time-out on the serial link. The time out value must be compatible with the serial speed Between 2 and 100 milliseconds Default : 5
R/W	S216	Flow Control	Indicates flow control type: <ul style="list-style-type: none"> • 0 Hardware: CTS/RTS • 2 None (default)
R/W	S218	Buffer Size	Indicates the maximum frames size that will be given to the Modem. When this size is reached, the modem resets the RTS signal. Between 30 and 240 Default : 230

4.2 Operation

Access	Register	Name	Description
Operation Mode			
R/W	S220	Function Mode	Operation Mode of the Modem. <ul style="list-style-type: none"> • 1= Transparent (Default) • 9= Addressed Secured
R/W	S221	Auto-Repeat	Indicates Auto Repeat Status: <ul style="list-style-type: none"> • 0= Auto-Repeat Off (Default) • 1= Auto Repeat On
R/W	S223	Number of Retries	Maximum recoveries count in case of problems in non Transparent (Non-Ack response to a message) mode. If this Register is at 0, the frames are not checked and considered as still good (used for the tests). Included between 0 and 255 Default: 2

4.3 Network Control

Access	Register	Name	Description
Addressed Secured Mode			
R/W	S252	Client Number	Indicates the modems receive Address. Between 0 and 255 Default: 0
R/W	S256	Default Addressee	Indicates the default address to which every radio frame will be sent. Default: 0 (inactive)

4.4 Radio Test Commands

These AT commands are provided to enable measurements during continuous transmission to be taken and are primarily used during radio tests (radiated power, bandwidth, etc.) to show conformance to the ETS 300 220 standard.

A test that is in progress will terminate if the modem receives a character from the

- ATT0 <CR>: Transmit pure carrier at centre frequency
- ATT1 <CR>: Transmit pure carrier representing '1'
- ATT2 <CR>: Transmit pure carrier representing '0'
- ATT3 <CR>: Transmit modulated carrier at maximum
- ATT6 <CR>: Transmit modulated carrier at minimum

Notes

- After entering an AT command (ended by <CR>), the modem acknowledges it by returning a code which is either "O", or "E". O = OK E=Error
- The commands are effective after a maximum delay of 10 ms. A new command can be entered after the current command has been acknowledged by the modem

Ordering Information

Part Number	Description
TYPHOON-800	RF modem, 800 Metre, RS232/485, IP68 enclosure
PSU-12V1AIN-IP	Power supply, 240Vac/12Vdc/1A, wall mount, 3-pin IEC mains plug

For more information or general enquiries, please contact

**R. F. Solutions Ltd.,
Unit 21, Cliffe Industrial Estate,
South Street, Lewes,
E Sussex, BN8 6JL. England**

Tel +44 (0)1273 898 000

Fax +44 (0)1273 480 661

Email sales@rfsolutions.co.uk

<http://www.rfsolutions.co.uk>