

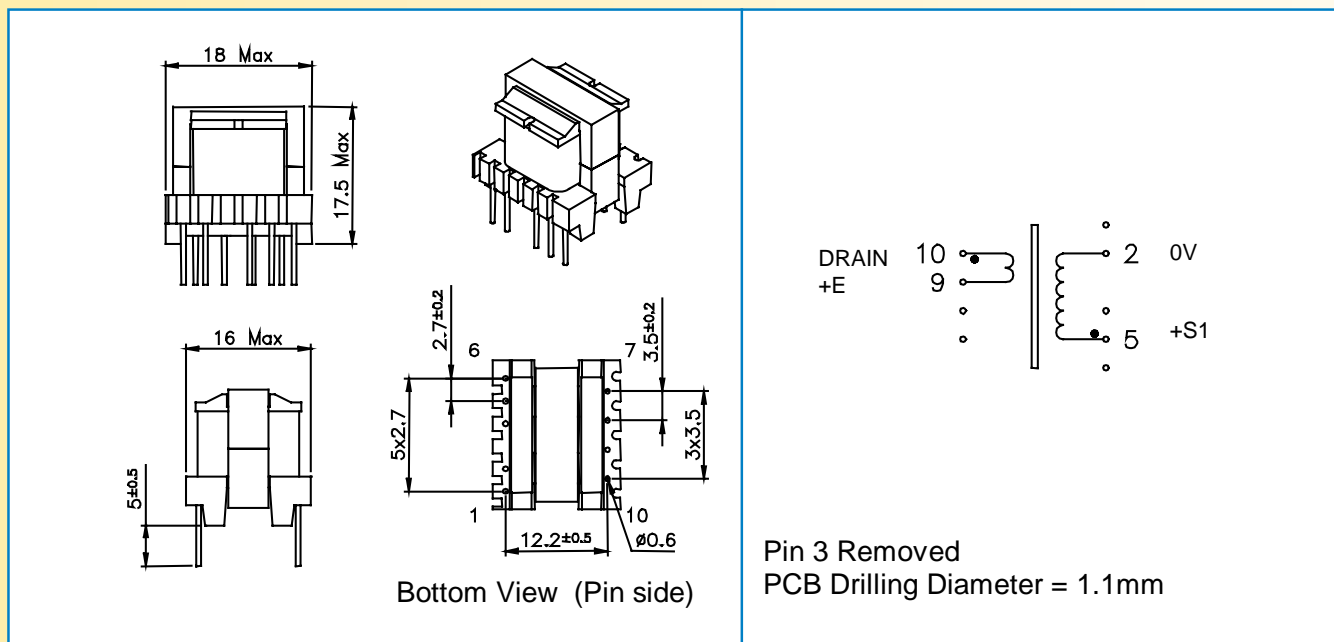

- Primary / Secondary Insulation  $\geq 4000V$
- Creepage distance Primary / Secondary  $\geq 6mm$
- Ambient temperature  $< 70^{\circ}C$
- Construction conforms to IEC950, IEC335, IEC61558 for reinforced insulation
- Exclusively uses UL94-V0 listed materials



MYRRA P / N	Output Power maximum	Windings					
			Pins	Turns	Voltage	Current maximum	Inductance (+/-10%)
74092	3.1 w	Pri	10 - 9	191	55 - 100 (VOR)	0.34 Apeak	4200µH
		S1	5 - 2	13	3.3 - 6 Vdc	0.9 Adc	
74093	3.1 w	Pri	10 - 9	191	65 - 125 (VOR)	0.34 Apeak	4200µH
		S1	5 - 2	24	7.5 - 15 Vdc	0.4 Adc	

Examples of application with Integrated Circuits :

MYRRA P / N	Control IC Manufacturer	Control IC P / N	Input voltage	Power	Frequency
74092	Power Integrations	TNY254	85 - 265Vrms	3.1w	44kHz
74093	Power Integrations	TNY254	85 - 265Vrms	3.1w	44kHz