

Configuration ANSMANN Version

- Push button for one hand operation
 - 1 x push: XENON "ON"
 - 2 x push: LUXEON "ON"
 - 3 x push: LUXEON "BLINKING" (~1Hz)
 - 4 x push: all lamps "OFF"
- With XENON lamp 6.5W 5W is the flash duration approx. 5h (main lamp)
- With LUXEON LED 1W is the flash duration approx. 20h (economy lamp)
- Filament breaks monitoring of the main lamp automatic switch over to economy lamp in the case of filament break
- Microprocessor-controlled technology for charge and discharge with battery capacity indication by means of five LEDs
- High protection IP 65
- High stability of the portable lamp
- Integrated pocket for insertable lenses e.g. diffuser
- Wall adapter for parking the portable lamp
- For 12V, 24V and 100-240V power supply
- Emergency light functions of the parked portable lamp, i.e. the portable lamp light in the event of mains failure

Technical data

Battery charge/discharge is indicated via five LEDs

Battery capacity	LED lights	indication	notes
>75%	green (5 LED)	■■■■■	
>50%	green (2 LED)	■■■■	
>25%	green (1 LED)	■■■■	
<25%	yellow (1 LED)	■■■■	charging required
<10%	red (1 LED)	■■■■	charging urgently required

Deep discharge protection : when the battery voltage is low (~5.3V, red LED-indication) automatic switching over from main lamp to economy lamp; residual lighted: >1h

Battery : Lead-acid, maintenance free, 6V 4.5Ah

Chargerfunktion : integrated into the lamp charging starts when lamp insert into the charger unit; voltage and charging current indication via LED's

Charging end voltage : at a regulated output voltage dropped over 7.2V the charger will be changed 6.9V for trickle charge
LED yellow is charge, LED green battery is fully charged

Charging current : approx. 0.9A, 1.3A

Charging time : approx. 3h...4.5h

Emergency light function : emergency light function with parked portable lamp
- in case of mains failure portable lamps goes in function (main lamp)

operating temperature : -20° +50°C

storage temperature : -20° +50°C

Input voltage : 100-240V AC 50/60Hz or AC/AC plug in power supply and 12V/24V input into the wall adapter

Mounting : for wall mounting incl. 4pcs panhead screws and 4pcs wall plugs

Safety class : II (all - insulated)

protection : lamp IP65 (EN 60529) / wall holder IP20

Approvals : emark, CE

Housing colour : black and Pantone "300 C" blue

Weight : XXXXg incl. accessories and package

Package : colour folding box

dimensions 345x272x135mm(LxWxH)

incl. adapter cable with a car lighter plug, exchangeable primary plug system, power supply and two colour disk diffuser

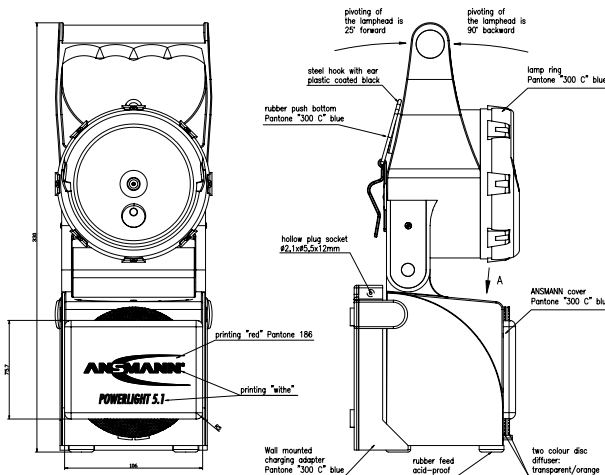

Push button for one hand operation:
 1 x push: XENON "ON"
 2 x push: LUXEON "ON"
 3 x push: LUXEON "BLINKING" (~1Hz)
 4 x push: all lamps "OFF"

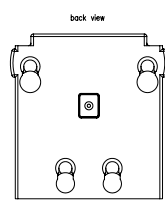
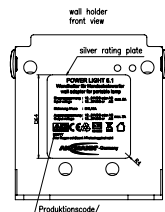
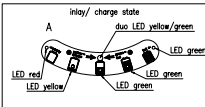
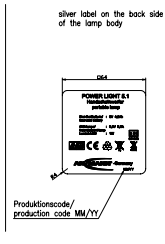
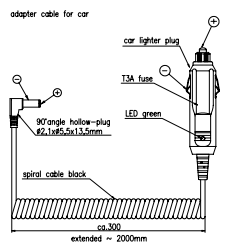
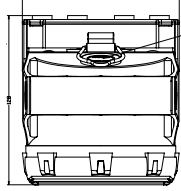

black label with white printing, scale 3:1

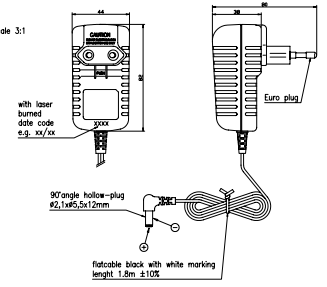

primary plug set



Technical data plug-in power supply

input data : 100-240V AC 50/60Hz 0.4A
 output data : 15V DC ±10% 1000mA
 insulation : 4kV primary/secondary
 protection : IP 20
 operating temperature : 0°C.....+25°C
 storage temperature : -25°C.....+70°C
 approval : CE, cULus, SAA, BEAR, GS
 case : plug-in case black

Part No.	Part Name	Part No.	Part Name
5802082	Working Lamp POWER LIGHT 5.1		
5802082	Working Lamp POWER LIGHT 5.1		