



Short Form Catalogue

Quick Reference Guide

Company profile

Weidmüller is the leading manufacturer of components for electrical and electronic interconnection technologies.

The company develops, produces and sells customer-oriented solutions comprising the entire Weidmüller product portfolio. As an OEM supplier, the company sets global standards in the field of electrical connection technology.

The Weidmüller product portfolio ranges from terminal blocks, PCB connectors and terminals, protected components, Industrial Ethernet components and relay sockets to power supply and overvoltage protection modules suitable for all applications. Electrical installation and marking solutions, basic I/O components and a variety of tools round off the range. Weidmüller products are mainly used in control cabinets and for field wiring. Customers also benefit from our wide range of services.

In addition to our expertise in manufacturing precision mechanics, we offer a customer oriented product portfolio for our international customers in the fields of industrial, process and transportation technology. Our developments and activities are driven solely by the individual requirements of our customers in these areas.

The Weidmüller Group has a strong international orientation with production facilities, sales companies and agencies in over 70 countries. Due to our high standards of quality and service, customers around the world value us as a highly competent and flexible partner.

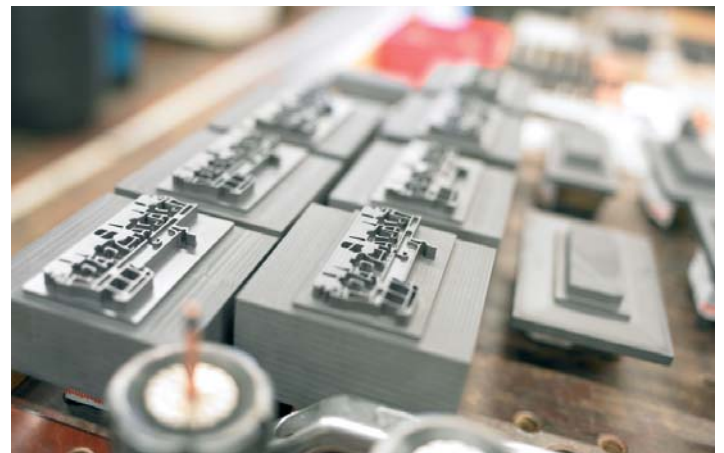

All the catalogues at a glance

Catalogue 1: Modular Terminal Blocks

Order number: 5650110000

- P-Series (Push In technology)
- I-Series (IDC technology)
- Z-Series (Tension clamp technology)
- W-Series (Screw connection technology)
- Stud style (Screw connection technology)

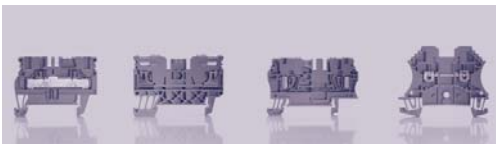

Catalogue 3: RockStar® – Heavy Duty Connectors

Order number: 5650130000

- Inserts
- Modular system
- Housings IP65 + IP69K



Catalogue 5: Enclosures and Cable Glands

Order number: 5650150000

- Enclosures
- Cable gland and Cabtite



Catalogue 2: PCB Terminals and Connectors

Order number: 5650120000

PCB Terminals with

- leaf spring connection, clamping yoke connection, TOP clamp connection, tension clamp connection, Push In spring connection, spade connection

PCB Connectors of

- Minimate, Omnimate, Unimate, Powermate and Crimpmate Ranges



Catalogue 4: Electronics

Order number: 5650140000

- Interface units
- Digital signal processing - relays, optos, timers
- Analogue signal processing
- Power supplies
- Overvoltage protection



Catalogue 6: Tools

Order number: 5650160000

- Cutting
- Stripping
- Crimping
- Screwdrivers
- Measuring/Testing
- Automatic machines



Catalogue 7: Marking Systems

Order number: 5650170000

- Terminal markers
- Wire and cable markers
- Device and equipment markers
- Printing systems
- Software



Catalogue 9: Industrial Ethernet

Order number: 5650190000

- Active components
- Passive components
- Accessories



Online Catalogue

If you have questions about the specifications and details of our products, perhaps even outside normal business hours, then our online catalogue at <http://catalog.weidmuller.com> – open 24 hours a day, 365 days a year – is the perfect source of information. Besides product features and part numbers, it contains extensive additional information on all product groups. For further information, specials and contacts, simply consult the Weidmüller website at www.weidmuller.ca

To access the online catalog click on the button:



Catalogue 8: Sensor Actuator Interface

Order number: 5650180000

- SAI Passive
- SAI Active
- Cables and connectors
- JACKPAC® IP67



Complete Set

Order number: 5650100000

- composed of catalogue 1 to catalogue 9 inclusive



CD-ROM

Order number: 5650500000

As well as browsing through our printed and online catalogues you can now gain an overview of our products with the help of our CD-ROM. You don't need Internet access nor do you have to install the CD. Simply insert the CD-ROM into the drive and browse away.

Please note that this Short Form Catalog is a *condensed* version of our complete catalog set, which is comprised of nine individual product line catalogs. Only a *selected* range of products are represented here. For details on SAI, PCB, enclosures or other products not referenced within, please refer to the applicable individual catalog, the catalog CD or our on-line catalog service.

This catalog has been created to provide an targeted overview of our vast range of products and as such will serve as a guide to your interface solutions. It is not, however, a replacement for technical discussion with a Product or Technical Applications Specialists when necessary. We welcome the opportunity to help our customers solve their individual challenges and to specify our products. Please call your local Sales Representative or speak to our Inside Sales staff or Technical Support staff at (905) 475-1507 or (800) 268-4080.

Every care has been taken to ensure the accuracy of our catalog data. We do not, however, accept responsibility for damage, loss or expense resulting from any error or omission. We reserve the right to make alterations in line with technical advances and industry standards. Goods are supplied accordance with our Terms and Conditions of Sale.

Note: Dimensions are in mm unless otherwise stated.

Short Form Catalogue**Terminal Blocks**

Circuit Breakers

Heavy Duty Connectors

Electronics

Tools

Installation Products

Industrial Ethernet

Appendix**Index**Search according to description or part number

Notes

Contents

A

B

C

D

E

F

G

Terminal Blocks

Terminal Blocks

W-Series	A.2
SAK-Series	A.6
Z-Series	A.10
I-Series	A.14
P-Series	A.16
DIN Mounting Rail and Accessories	A.16

Terminal Blocks - W Series

W Series - Feed Through Terminal Blocks



WDU 2.5



WDK 2.5 ZQV

W Series - Ground Terminal Blocks

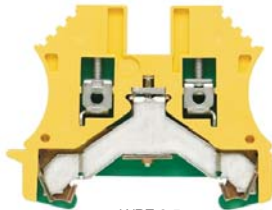

WPE 2.5



WDK 2.5PE

W Series - Fuse Terminal Blocks

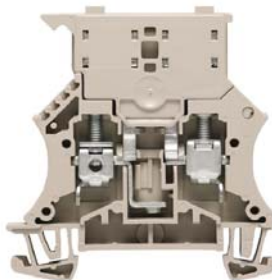

WSI 6

* Note: WSI 6 uses 5x20mm fuses
WSI 6/2 uses 1¼"x¼" fuses

Ratings/Width	Wire Range	Part Number	Description
600V/20A/5mm	26-12 AWG	102000000	WDU 2.5
600V/20A/6mm	26-10 AWG	102010000	WDU 4
600V/45A/8mm	20-8 AWG	102020000	WDU 6
600V/65A/10mm	16-6 AWG	102030000	WDU 10
600V/65A/12mm	14-6 AWG	102040000	WDU 16
600V/120A/16mm	12-2 AWG	102050000	WDU 35
600V/205A/27mm	6-2/0 AWG	102460000	WDU 70/95
600V/285A/32mm	2-250MCM	102450000	WDU 120/150
600V/400A/36mm	1/0-500MCM	180278000	WDU 240
300V/10A/5mm	26-12 AWG	102150000	WDK 2.5
300V/25A/5mm	26-12 AWG	104110000	WDK 2.5 ZQV
300V/10A/5mm	26-12 AWG	102230000	WDK 2.5V
300V/20A/5mm	26-12 AWG	104160000	WDK 2.5N
300V/20A/5mm	26-12 AWG	104161000	WDK 2.5NV
300V/30A/6mm	26-10 AWG	104190000	WDK 4N
300V/30A/6mm	26-10 AWG	104191000	WDK 4NV
600V/5mm	26-12 AWG	101000000	WPE 2.5
600V/6mm	26-10AWG	101010000	WPE 4
600V/8mm	20-8 AWG	101020000	WPE 6
600V/10mm	16-6 AWG	101030000	WPE 10
600V/12mm	14-6 AWG	101040000	WPE 16
600V/16mm	12-2 AWG	101050000	WPE 35
600V/27mm	6-2/0 AWG	103730000	WPE 70/95
600V/32mm	2-250MCM AWG	101970000	WPE 120/150
300V/5mm	26-12 AWG	103630000	WDK 2.5PE
300V/5mm	26-12 AWG	104162000	WDK 2.5N PE
300V/6mm	26-10 AWG	104192000	WDK 4N PE
300V/10A/8mm	20-8 AWG	101100000	WSI 6 *
300V/10A/8mm	20-8 AWG	101130000	WSI 6 LD 10-36VAC/DC *
300V/10A/8mm	20-8 AWG	101220000	WSI 6 LD 30-70VAC/DC *
300V/10A/8mm	20-8 AWG	101230000	WSI 6 LD 60-150VAC/DC *
300V/10A/8mm	20-8 AWG	101240000	WSI 6 LD 140-250VAC/DC *
300V/10A/12mm	20-8 AWG	101400000	WSI 6/2 *
300V/10A/12mm	20-8 AWG	101410000	WSI 6/2 LD 10-36VAC/DC *
300V/10A/12mm	20-8 AWG	101420000	WSI 6/2 LD 30-70VAC/DC *
300V/10A/12mm	20-8 AWG	101430000	WSI 6/2 LD 60-150VAC/DC *
300V/10A/12mm	20-8 AWG	101440000	WSI 6/2 LD 140-250VAC/DC *

Terminal Blocks - W Series

End Plate / Partition	End Bracket *	Jumpers (# of poles)	Labels	DIN Rail *	Screwdriver
105000000/105010000	0383560000/1061200000	1054460000/1909000000 (10/20)	1609860000	0514500000	9008320000
105000000/105010000	0383560000/1061200000	1052060000/1909000000 (10/20)	1609900000	0514500000	9008330000
105000000/105010000	0383560000/1061200000	1052260000/0545400000 (10/58)	1609920000	0514500000	9008340000
105000000/105010000	0383560000/1061200000	1052460000 (10)	1609920000	0514500000	9008350000
1050100000	1061200000/1059000000	1053360000 (10)	1609920000	0514500000	9009350000
1050100000	1061200000/1059000000	1053160000 (10)	1609920000	0514500000	9009010000
N/A	1061200000/1059000000	1063600000 (3)	1609920000	0514500000	9008860000
N/A	1061200000/1059000000	1063300000/1063400000 (2/3)	1609920000	0514500000	9008860000
N/A	1061200000/1059000000	1802790000/1802800000 (2/3)	1609880000	0514500000	9008860000
1059100000/1058800000	0383560000/1061200000	1054460000 (10)	1640740000	0514500000	9008320000
1059100000/1058800000	0383560000/1061200000	1909000000 (20)	1640740000	0514500000	9008320000
1059100000/1058800000	0383560000/1061200000	1054460000 (10)	1640740000	0514500000	9008320000
1084000000/1058800000	0383560000/1061200000	1909000000 (20)	1640740000	0514500000	9008320000
1084000000/1058800000	0383560000/1061200000	1909000000 (20)	1640740000	0514500000	9008320000
1084000000/1058800000	0383560000/1061200000	1909000000 (20)	1640740000	0514500000	9008320000
1084000000/1058800000	0383560000/1061200000	1909000000 (20)	1640740000	0514500000	9008320000
1050000000/1050100000	0383560000/1061200000	N/A	1609860000	0514500000	9008320000
N/A	0383560000/1061200000	N/A	1609900000	0514500000	9008330000
N/A	0383560000/1061200000	N/A	1609920000	0514500000	9008340000
N/A	0383560000/1061200000	N/A	1609920000	0514500000	9008350000
N/A	0383560000/1061200000	N/A	1609920000	0514500000	9008350000
N/A	0383560000/1061200000	N/A	1609920000	0514500000	9009010000
N/A	1061200000/1059000000	N/A	1609920000	0514500000	9008860000
N/A	1061200000/1059000000	N/A	1609920000	0514500000	9008860000
1059100000	0383560000/1061200000	N/A	1640740000	0514500000	9008320000
1084000000	0383560000/1061200000	N/A	1640740000	0514500000	9008320000
1084000000	0383560000/1061200000	N/A	1640740000	0514500000	9008320000
1050000000/1050100000	0383560000/1061200000	0338000000 + 1052100000 (10)	1609920000	0514500000	9008340000
1050000000/1050100000	0383560000/1061200000	0338000000 + 1052100000 (10)	1609920000	0514500000	9008340000
1050000000/1050100000	0383560000/1061200000	0338000000 + 1052100000 (10)	1609920000	0514500000	9008340000
1050000000/1050100000	0383560000/1061200000	0338000000 + 1052100000 (10)	1609920000	0514500000	9008340000
1050000000/1050100000	0383560000/1061200000	0338000000 + 1052100000 (10)	1609920000	0514500000	9008340000
1050000000/1050100000	0383560000/1061200000	0338000000 + 1052100000 (10)	1609920000	0514500000	9008340000
1050000000/1050100000	0383560000/1061200000	0338000000 + 1052100000 (10)	1609920000	0514500000	9008340000
1050000000/1050100000	0383560000/1061200000	0338000000 + 1052100000 (10)	1609920000	0514500000	9008340000
1050000000/1050100000	0383560000/1061200000	0338000000 + 1052100000 (10)	1609920000	0514500000	9008340000
1050000000/1050100000	0383560000/1061200000	0338000000 + 1052100000 (10)	1609920000	0514500000	9008340000
1050000000/1050100000	0383560000/1061200000	0338000000 + 1052100000 (10)	1609920000	0514500000	9008340000

* See page A.16 for details or other options

Terminal Blocks - W Series

W Series - Fuse Terminal Blocks



WSI 4/2

* Note: WSI 4/2 uses 1¼"x¼" fuses

W Series - Disconnect Terminal Blocks



WTR 2.5

Rating/Width	Wire Range	Part Number	Description
300V/15A/9mm	30-10 AWG	1880430000	WSI 4/2 *
300V/15A/9mm	30-10 AWG	1880410000	WSI 4/2 LD 10-36V AC/DC *
300V/15A/9mm	30-10 AWG	1880440000	WSI 4/2 LD 30-70V AC/DC *
300V/15A/9mm	30-10 AWG	1880420000	WSI 4/2 LD 60-150V AC/DC *
300V/15A/9mm	30-10 AWG	1880390000	WSI 4/2 LD 140-250V AC/DC *
300V/10A/5mm	26-12 AWG	1855610000	WTR 2.5
300V/10A/5mm	26-12 AWG	1855620000	WTR 2.5 STB
300V/10A/6mm	26-12 AWG	7910180000	WTR 4
300V/10A/6mm	26-12 AWG	7910210000	WTR 4 STB

Terminal Blocks - SAK Series

SAK Series - Feed Through Terminal Blocks

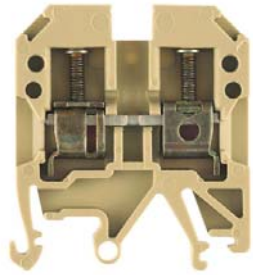

SAK 4/EN

Ratings/Width	Wire Range	Part Number	Description
600V/25A/6mm	26-10 AWG	0380420000	SAK 2.5/35 KRG
600V/25A/6mm	26-10 AWG	0279620000	SAK 2.5 KRG
600V/25A/6mm	26-10 AWG	0380460000	SAK 2.5/35 PA
600V/25A/6mm	26-10 AWG	0279660000	SAK 2.5 PA
600V/25A/6mm	26-10 AWG	0218660000	SAK 2.5/EN
600V/36A/6.5mm	26-10 AWG	0443620000	SAK 4/35 KRG
600V/36A/6.5mm	26-10 AWG	0128320000	SAK 4 KRG
600V/36A/6.5mm	26-10 AWG	0443660000	SAK 4/35 PA
600V/36A/6.5mm	26-10 AWG	1716240000	SAK 4 PA
600V/36A/6.5mm	26-10 AWG	0467460000	SAK 4/EN
600V/47A/8mm	20-8 AWG	0380520000	SAK 6N/35 KRG
600V/47A/8mm	20-8 AWG	0193220000	SAK 6N KRG
600V/47A/8mm	20-8 AWG	0380560000	SAK 6/35 PA
600V/47A/8mm	20-8 AWG	0193260000	SAK 6N PA
600V/47A/8mm	26-8 AWG	0212860000	SAK 6 EN
600V/65A/10mm	14-6 AWG	0443720000	SAK 10/35 KRG
600V/65A/10mm	14-6 AWG	0110020000	SAK 10 KRG
600V/65A/10mm	14-6 AWG	0443760000	SAK 10/35 PA
600V/65A/10mm	14-6 AWG	0110060000	SAK 10 PA
600V/65A/10mm	16-16 AWG	0337660000	SAK 10 EN
600V/87A/12mm	10-4 AWG	0380620000	SAK 16/35 KRG
600V/87A/12mm	10-4 AWG	0271020000	SAK 16 KRG
600V/87A/12mm	10-4 AWG	0380660000	SAK 16/35 PA
600V/87A/12mm	10-4 AWG	0271060000	SAK 16 PA
600V/87A/12mm	10-4 AWG	0339760000	SAK 16 EN
600V/145A/18mm	6-2 AWG	0608220000	SAK 35N/35 KRG
600V/145A/18mm	6-2 AWG	0303520000	SAK 35 KRG
600V/120A/18mm	12-2 AWG	0608260000	SAK 35N/35 PA
600V/120A/18mm	12-2 AWG	0550660000	SAK 35N PA
600V/145A/18mm	6-2 AWG	0339860000	SAK 35 EN

Terminal Blocks - SAK Series

End Plate / Partition	End Bracket *	Jumpers (# of poles)	Labels	DIN Rail *	Screwdriver
0279520000 / 0302820000	0383560000	0368700000 (10)	1609820000	0514500000	9008330000
0279520000 / 0302820000	0206160000	0368700000 (10)	1609820000	0122800000	9008330000
0460560000 / 0302860000	0383560000	0368700000 (10)	1609820000	0514500000	9008330000
0279560000 / 0302860000	0206160000	0368700000 (10)	1609820000	0122800000	9008330000
0460560000 / 0302860000	0383560000 / 0206160000	0368700000 (10)	1609820000	0514500000 / 0122800000	9008330000
0117920000 / 0130120000	0383560000	0368700000 (10)	1609840000	0514500000	9008330000
0117920000 / 0130120000	0206160000	0368800000 (10)	1609840000	0122800000	9008330000
0117960000 / 0130160000	0383560000	0368800000 (10)	1609840000	0514500000	9008330000
0117960000 / 0130160000	0206160000	0368800000 (10)	1609840000	0122800000	9008330000
0117960000 / 0130160000	0383560000	0368800000 (10)	1609840000	0514500000 / 0122800000	9008330000
0117920000 / 0130120000	0383560000	0457000000 (10)	1609840000	0514500000	9008350000
0117920000 / 0130120000	0206160000	1063300000/1063400000 (2/3)	1609840000	0122800000	9008350000
0117960000 / 0130160000	0383560000	0368800000 (10)	1277060000	0514500000	9008350000
0117960000 / 0130160000	0206160000	0457000000 (10)	1277060000	0122800000	9008350000
0117960000 / 0130160000	0383560000 / 0206160000	0457000000 (10)	1609840000	0514500000 / 0122800000	9008350000
0117920000 / 0130120000	1061200000	0457400000 (10)	1609840000	0514500000	9008350000
0117920000 / 0130120000	1067600000	0457400000 (10)	1609840000	0122800000	9008350000
0117960000 / 0130160000	1061200000	0457400000 (10)	1609840000	0514500000	9008350000
0117960000 / 0130160000	1067600000	0457400000 (10)	1609840000	0122800000	9008350000
0117960000 / 0130160000	0383560000 / 0206160000	0457400000 (10)	1609840000	0514500000 / 0122800000	9008350000
0271120000 / 0281120000	1061200000	0457800000 (10)	1609801044	0514500000	9008350000
0271120000 / 0281120000	1067600000	0457800000 (10)	1609801044	0122800000	9008350000
0271160000 / 0303660000	1061200000	0457800000 (10)	1609801044	0514500000	9008350000
0271160000 / 0303660000	1067600000	0457800000 (10)	1609801044	0122800000	9008350000
0271160000 / 0303660000	1061200000 / 1067600000	0457800000 (10)	1609801044	0514500000 / 0122800000	9008350000
0303620000 / 0304320000	1061200000	033860 + 026700 + 026710 (10)	1609801044	0514500000	9009010000
0303620000 / 0304320000	1067600000	033860 + 026700 + 026710 (10)	1609801044	0122800000	9009010000
0303660000 / 0304360000	1061200000	056520 + 026700 + 026710 (10)	1609801044	0514500000	9009010000
0303660000 / 0304360000	1067600000	056520 + 026700 + 026710 (10)	1609801044	0122800000	9009010000
0303660000 / 0304330000	1061200000 / 1067600000	033860 + 026700 + 026710 (10)	1609801044	0514500000 / 0122800000	9009010000

Terminal Blocks

A

* See page A.16 for details or other options

Terminal Blocks - SAK Series

SAK Series - Ground Terminal Blocks



EK 2.5N

Ratings/Width	Wire Range	Part Number	Description
600V/6mm	26-10 AWG	0661060000	EK 2.5/35 PA
600V/6mm	26-10 AWG	0474360000	EK 2.5N PA
600V/8mm	26-10 AWG	0661160000	EK 4/35 PA
600V/8mm	26-10 AWG	0354560000	EK 4 PA
600V/8mm	20-8 AWG	0661260000	EK 6/35 PA
600V/10mm	14-6 AWG	0661360000	EK 10/35 PA
600V/10mm	14-6 AWG	0354660000	EK 10 PA
600V/12mm	10-4 AWG	0190160000	EK 16/35 PA
600V/12mm	10-2 AWG	0374660000	EK 16 PA
600V/18mm	12-2 AWG	0661460000	EK 35/35 PA
600V/18mm	10-2 AWG	0354760000	EK 35 PA

SAK Series - Fuse Terminal Blocks

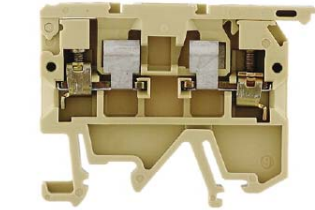

ASK 1/EN

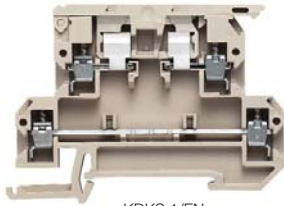

KDKS 1/EN

* Note: ASK /SAKS 1 uses 5x20mm fuses
 KDKS uses 5x20mm/5x25mm fuses
 SAKS 3/SAKS 6 uses 1 1/4"x3/4" fuses

300V/10A/8mm	26-12 AWG	0474560000	ASK 1 EN PA
300V/10A/8mm	26-12 AWG	0222760001	ASK1EN/SMT10-60Vuc BFI H-
300V/10A/8mm	26-12 AWG	9123140001	ASK1EN/SMT10-60Vuc BFI H+
300V/10A/8mm	26-12 AWG	0225560001	ASK1EN/SMT100-250Vuc BFI H-
300V/10A/8mm	26-12 AWG	9118290001	ASK1EN/SMT100-250Vuc BFI H+
300V/10A/8mm	26-12 AWG	9503350000	KDKS 1 EN PA
300V/10A/8mm	26-12 AWG	9802720001	KDKS1EN/SMT10-60Vuc BFI H-
300V/10A/8mm	26-12 AWG	9908510001	KDKS1EN/SMT10-60Vuc BFI H+
300V/10A/8mm	26-12 AWG	9802760001	KDKS1EN/SMT100-250Vuc BFI H-
300V/10A/8mm	26-12 AWG	9915820001	KDKS1EN/SMT100-250Vuc BFI H+
300V/10A/8mm	26-12 AWG	9528110000	KDKS 1 PE PA
300V/10A/8mm	26-12 AWG	9158330001	KDKS1PE/SMT10-60Vuc BFI H-
300V/10A/8mm	26-12 AWG	9158340001	KDKS1PE/SMT10-60Vuc BFI H+
300V/10A/8mm	26-12 AWG	9158350001	KDKS1PE/SMT100-250Vuc BFI H-
300V/10A/8mm	26-12 AWG	9915150001	KDKS1PE/SMT100-250Vuc BFI H+
600V/10A/13mm	26-10 AWG	0501600000	SAKS 1/35
600V/10A/13mm	26-10 AWG	0191220000	SAKS 1 KRG
600V/10A/13mm	26-10 AWG	0501620000	SAKS 1/35/35 KRG
600V/10A/13mm	22-10 AWG	0328920000	SAKS 3/35 KRG
600V/10A/13mm	22-10 AWG	0297520000	SAKS 3 KRG
300V/10A/13mm	20-8 AWG	0531820000	SAKS 6/32 KRG

Terminal Blocks - SAK Series

End Plate / Partition	End Bracket *	Jumpers (# of poles)	Labels	DIN Rail *	Screwdriver
N/A	N/A	N/A	1609820000	0514500000	9008330000
N/A	N/A	N/A	1609820000	0122800000	9008330000
N/A	N/A	N/A	1609840000	0514500000	9008330000
N/A	N/A	N/A	1609840000	0122800000	9008330000
N/A	N/A	N/A	1609840000	0514500000	9008340000
N/A	N/A	N/A	1609800000	0514500000	9008350000
N/A	N/A	N/A	1609800000	0122800000	9008350000
N/A	N/A	N/A	1609800000	0514500000	9008350000
N/A	N/A	N/A	1609800000	0122800000	9008350000
N/A	N/A	N/A	1609800000	0514500000	9009010000
N/A	N/A	N/A	1609800000	0122800000	9008350000
0380360000	0383560000	0545400000 + 0546000000 (58)	1609800000	0514500000 / 0122800000	9008330000
0380360000	0383560000	0545400000 + 0546000000 (58)	1609800000	0514500000 / 0122800000	9008330000
0380360000	0383560000	0545400000 + 0546000000 (58)	1609800000	0514500000 / 0122800000	9008330000
0380360000	0383560000	0545400000 + 0546000000 (58)	1609800000	0514500000 / 0122800000	9008330000
0380360000	0383560000	0545400000 + 0546000000 (58)	1609800000	0514500000 / 0122800000	9008330000
9503330000	1061200000	0545400000 + 0546000000 (58)	1609800000	0514500000 / 0122800000	9008330000
9503330000	1061200000	0545400000 + 0546000000 (58)	1609800000	0514500000 / 0122800000	9008330000
9503330000	1061200000	0545400000 + 0546000000 (58)	1609800000	0514500000 / 0122800000	9008330000
9503330000	1061200000	0545400000 + 0546000000 (58)	1609800000	0514500000 / 0122800000	9008330000
9503330000	1061200000	0545400000 + 0546000000 (58)	1609800000	0514500000 / 0122800000	9008330000
9503330000	1061200000	0545400000 + 0546000000 (58)	1609800000	0514500000 / 0122800000	9008330000
9503330000	1061200000	0545400000 + 0546000000 (58)	1609800000	0514500000 / 0122800000	9008330000
9503330000	1061200000	0545400000 + 0546000000 (58)	1609800000	0514500000 / 0122800000	9008330000
9503330000	1061200000	0545400000 + 0546000000 (58)	1609800000	0514500000 / 0122800000	9008330000
9503330000	1061200000	0545400000 + 0546000000 (58)	1609800000	0514500000 / 0122800000	9008330000
0191320000	1061200000	N/A	1609800000	0514500000	9008350000
0191320000	1061200000	N/A	1609800000	0514500000	9008350000
0191320000	1061200000	N/A	1609800000	0514500000	9008350000
0191320000	1061200000	N/A	1609800000	0514500000	9008350000
0191320000	1061200000	N/A	1609800000	0514500000	9008350000
0146720000	0206160000	0338800000 + 0346200000 (10)	1609820000	0122800000	9008350000

* See page A.16 for details or other options

Terminal Blocks - SAK & Z Series

SAK Series - Disconnect Terminal Blocks



SAKR

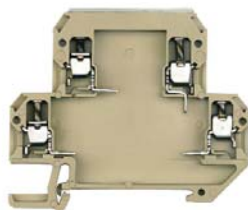

DKT 4

Ratings/Width	Wire Range	Part Number	Description
300V/10A/6.5mm	26-12 AWG	0412120000	SAKR KRG
300V/10A/6.5mm	26-12 AWG	0172160000	SAKR/35 PA
300V/10A/6.5mm	26-12 AWG	0412160000	SAKR PA
300V/10A/6.5mm	26-12 AWG	0687460000	DKT 4/35 KRG
300V/10A/6mm	26-12 AWG	0687360000	DKT 4 KRG
300V/10A/6mm	26-12 AWG	0687460000	DKT 4/35 PA
300V/10A/6mm	26-12 AWG	0687460000	DKT 4 PA
300V/25A/6.5mm	22-10 AWG	0357520000	SAKC 4/35 KRG
300V/25A/6.5mm	22-10 AWG	0340720000	SAKC 4 KRG
600V/25A/12mm	20-10 AWG	1404620000	SAKC 10/35 KRG
600V/25A/12mm	20-10 AWG	0324120000	SAKC 10 KRG

Z Series - Feed Through Terminal Blocks

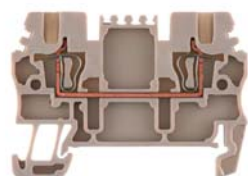

ZDU 1.5



ZDU 6-2/2AN

300V/20A/3.5mm	26-14 AWG	1775480000	ZDU 1.5
300V/20A/3.5mm	26-14AWG	1775530000	ZDU 1.5/3AN
600V/27A/5mm	26-12 AWG	1608510000	ZDU 2.5
600V/23A/5mm	26-14 AWG	1772060000	ZDU 2.5-2
600V/35A/6mm	26-10 AWG	1632050000	ZDU 4
600V/35A/6mm	26-10 AWG	1770370000	ZDU 4-2/2AN
600V/35A/6mm	26-10 AWG	7904180000	ZDU 4/3AN
600V/50A/8mm	20-8 AWG	1608620000	ZDU 6
600V/50A/8mm	20-8 AWG	1771380000	ZDU 6-2/2AN
600V/50A/8mm	20-8 AWG	7907410000	ZDU 6/3AN
600V/55A/10mm	16-6 AWG	1746750000	ZDU 10
600V/55A/10mm	16-6 AWG	1767690000	ZDU 10/3AN
600V/65A/12mm	14-4 AWG	1745230000	ZDU 16
600V/65A/12mm	14-4 AWG	1768320000	ZDU 16/3 AN
600V/120A/16mm	12-2 AWG	1739620000	ZDU 35

Z Series - Ground Terminal Blocks



ZPE 2.5



ZDK 2.5-2 PE

300V/3.5mm	26-14 AWG	1775510000	ZPE 1.5
600V/5mm	26-12 AWG	1608640000	ZPE 2.5
600V/5mm	26-14 AWG	1772090000	ZPE 2.5-2
600V/3.5mm	26-12 AWG	1791010000	ZDK 2.5-2 PE
600V/6mm	26-10 AWG	1632080000	ZPE 4
600V/6mm	26-10 AWG	1770380000	ZPE 4-2/2AN
600V/8mm	20-8 AWG	1608670000	ZPE 6
600V/8mm	20-8 AWG	1771370000	ZPE 6-2/2AN
600V/10mm	16-6 AWG	1746770000	ZPE 10
600V/12mm	14-4 AWG	1745250000	ZPE 16
600V/16mm	12-2 AWG	1739650000	ZPE 35

Terminal Blocks - SAK & Z Series

End Plate / Partition	End Bracket *	Jumpers (# of poles)	Labels	DIN Rail *	Screwdriver
0211320000	0206160000	0482900000 (4)	1609840000	0122800000	9008330000
0211360000	0383560000	0482900000 (4)	1609840000	0514500000	9008330000
0211360000	0206160000	0482900000 (4)	1609840000	0122800000	9008330000
0687560000	0383560000	0482900000 (4)	1609820000	0514500000	9008330000
0687360000	0206160000	0482900000 (4)	1609820000	0122800000	9008330000
0687560000	0383560000	0482900000 (4)	1609820000	0514500000	9008330000
0687560000	0206160000	0482900000 (4)	1609820000	0122800000	9008330000
0117920000	0383560000	0482900000 (4)	1609840000	0514500000	9008330000
0117920000	0206160000	0482900000 (4)	1609840000	0122800000	9008330000
0146720000	0383560000	0338500000 (10)	1609840000	0514500000	9008330000
0146720000	0206160000	0338500000 (10)	1609840000	0122800000	9008330000
1776030000	9540000000	1776200000 (10)	1778270000	0514500000	9037160000
1776060000	9540000000	1776200000 (10)	1609900000	0514500000	9037160000
1608740000	9540000000	1908960000 (20)	1635000000	0514500000	9008330000
1706110000	9540000000	1608940000 (10)	1768090000	0514500000	9008330000
1632090000	9540000000	1609030000 (10)	1828450000	0514500000	9008330000
1770400000	9540000000	1609030000 (10)	1609900000	0514500000	9008330000
7904100000	9540000000	1609030000 (10)	1609900000	0514500000	9009330000
1608830000	9540000000	1908990000 (24)	1609900000	0514500000	9008350000
1771440000	9540000000	1908990000 (24)	1277060000	0514500000	9008340000
7907410000	9540000000	1908990000 (24)	1609900000	0514500000	9008350000
1748660000	9540000000	1739680000 (2)	1609860000	0514500000	9008350000
1749580000	9540000000	1739680000 (2)	1609860000	0514500000	9008350000
1745150000	9540000000	1739690000 (2)	1609880000	0514500000	9008350000
1749580000	9540000000	N/A	1609880000	0514500000	9008350000
1739620000	9540000000	1739700000 (2)	1609880000	0514500000	9008350000
1776030000	9540000000	N/A	1778270000	0514500000	9037160000
1608740000	9540000000	N/A	1635000000	0514500000	9008330000
1706110000	9540000000	N/A	1768090000	0514500000	9008330000
1791050000	9540000000	N/A	1635000000	0514500000	9008320000
1632080000	9540000000	N/A	1609900000	0514500000	9008330000
1770400000	9540000000	N/A	1609900000	0514500000	9008330000
1608830000	9540000000	N/A	1609900000	0514500000	9008350000
1771440000	9540000000	N/A	1277060000	0514500000	9008340000
1748660000	9540000000	N/A	1609900000	0514500000	9008350000
1745150000	9540000000	N/A	1609880000	0514500000	9008350000
N/A	9540000000	N/A	1609880000	0514500000	9008350000

* See page A.16 for details or other options

Terminal Blocks - Z Series

Z Series - Fuse Terminal Blocks



ZSI 2.5



ZSI 6-2

* Note: ZSI 2.5 uses 5x25mm fuses
 ZSI 6 uses 5x20mm/5x25mm fuses
 ZSI 16-2/FC uses automotive fuses

Z Series - Disconnect Terminal Blocks



ZTR 2.5

Ratings/Width	Wire Range	Part Number	Description
600V/15A/8mm	26-12 AWG	1616400000	ZSI 2.5 *
600V/15A/8mm	26-12 AWG	1616440000	ZSI 2.5/LD 10-36 AC/DC *
600V/15A/8mm	26-12 AWG	1616430000	ZSI 2.5/LD 30-70 AC/DC *
600V/15A/8mm	26-12 AWG	1616420000	ZSI 2.5/LD 60-150 AC/DC *
600V/15A/8mm	26-12 AWG	1616410000	ZSI 2.5/LD 140-250 AC/DC *
600V/15A/8mm	26-12 AWG	1730900000	ZSI 2.5/ 5X25 *
600V/15A/8mm	26-12 AWG	1616460000	ZSI 2.5/2 *
600V/15A/8mm	26-12 AWG	1616470000	ZSI 2.5/2/LD 10-36 AC/DC *
600V/15A/8mm	26-12 AWG	1616480000	ZSI 2.5/2/LD 30-70 AC/DC *
300V/10A/8mm	26-12 AWG	1616490000	ZSI 2.5/2/LD 60-150 AC/DC *
300V/15A/8mm	26-12 AWG	1616500000	ZSI 2.5/2/LD 140-250 AC/DC *
300V/10A/12.2mm	26-8 AWG	1820930000	ZSI 6-2 *
300/25A/8mm	22-10 AWG	1814690000	ZSI 6-2/FC *
300V/10A/5mm	26-12 AWG	1831130000 + 7921590000	ZTR 2.5/SI
300V/10A/5mm	26-12 AWG	1831130000 + 7921570000	ZTR 2.5/SI LD 10-36V
300V/10A/5mm	26-12 AWG	1831130000 + 7921580000	ZTR 2.5/SI LD 30-70V
300V/10A/5mm	26-12 AWG	1831130000 + 7921590000	ZTR 2.5/SI LD 60-150V
300V/10A/5mm	26-12 AWG	1831130000 + 7921600000	ZTR 2.5/SI LD 140-250V
300V/15A/5mm	26-12 AWG	1831280000	ZTR 2.5
300V/15A/5mm	26-12 AWG	8731720000	ZTR 2.5/3AN
300V/10A/5mm	26-12 AWG	7920900000	ZTR 2.5/4AN
300V/10A/5mm	26-12 AWG	1745400000	ZDTR 2.5

Terminal Blocks - Z Series

End Plate / Partition	End Bracket *	Jumpers (# of poles)	Labels	DIN Rail *	Screwdriver
160880000	954000000	1627870000 (4)	1635000000	0514500000	9008330000
160880000	954000000	1627870000 (4)	1635000000	0514500000	9008330000
160880000	954000000	1627870000 (4)	1635000000	0514500000	9008330000
160880000	954000000	1627870000 (4)	1635000000	0514500000	9008330000
160880000	954000000	1627870000 (4)	1635000000	0514500000	9008330000
160880000	954000000	1627870000 (4)	1635000000	0514500000	9008330000
N/A	954000000	1633220000 (4)	1635000000	0514500000	9008330000
N/A	954000000	1633220000 (4)	1635000000	0514500000	9008330000
N/A	954000000	1633220000 (4)	1635000000	0514500000	9008330000
N/A	954000000	1633220000 (4)	1635000000	0514500000	9008330000
N/A	954000000	1633220000 (4)	1635000000	0514500000	9008330000
1814710000	954000000	1627870000 (4)	1635000000	0514500000	9008340000
1814711111	954000000	1627870000 (4)	1635000000	0514500000	9008340000
1608770000	954000000	1608940000 (10)	1635000000	0514500000	9008330000
1608770000	954000000	1608940000 (10)	1635000000	0514500000	9008330000
1608770000	954000000	1608940000 (10)	1635000000	0514500000	9008330000
1608770000	954000000	1608940000 (10)	1635000000	0514500000	9008330000
1608770000	954000000	1608940000 (10)	1635000000	0514500000	9008330000
1608770000	954000000	1608940000 (10)	1609860000	0514500000	9008330000
1608800000	954000000	1608940000 (10)	1609860000	0514500000	9008330000
1608800000	954000000	1608940000 (10)	1609900000	0514500000	9008330000
1745420000	954000000	1693880000 (10)	1609900000	0514500000	9008330000

* See page A.16 for details or other options

Terminal Blocks - I Series

Terminal Blocks

A

I Series - Feed Through Terminal Blocks



IDU 1.5N



IDK 1.5N

I Series - Ground Terminal Blocks

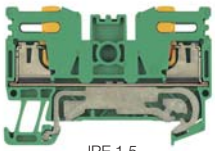

IPE 1.5

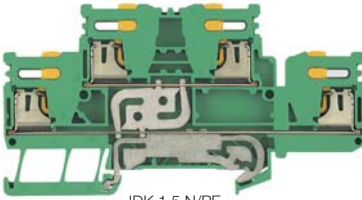

IDK 1.5 N/PE



IPE 2.5N/ZF

I Series - Fuse Terminal Blocks



ITR 2.5N/SI

* Note: ITR uses 5x20mm fuses

I Series - Disconnect Terminal Blocks

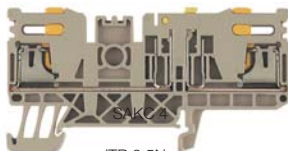

ITR 2.5N







Ratings/Width	Wire Range	Part Number	Description
300V/10A/5mm	24-16 AWG	1792540000	IDU 1.5N
300V/10A/5mm	24-16 AWG	1792570000	IDU 1.5N/3AN
300V/10A/5mm	24-16 AWG	1792600000	IDU 1.5N/4AN
300V/10A/5mm	24-16 AWG	1792700000	IDU 1.5N/ZF
300V/10A/5mm	24-16 AWG	1806150000	IDU 1.5N/ZF/3AN
300V/10A/5mm	24-16 AWG	1792730000	IDU 1.5N/ZB
300V/10A/5mm	24-16 AWG	1806170000	IDU 1.5N/ZB/3AN
300V/10A/5mm	24-16 AWG	1792650000	IDK 1.5N
600V/15A/5mm	20-14 AWG	1812900000	IDU 2.5N
600V/15A/6mm	20-14 AWG	1812930000	IDU 2.5N/3AN
600V/15A/6mm	20-14 AWG	1812960000	IDU 2.5N/4AN
600V/15A/6mm	20-14 AWG	1821260000	IDU 2.5N/ZF
600V/15A/6mm	20-14 AWG	1821290000	IDU 2.5N/ZB
600V/15A/6mm	20-14 AWG	1848300000	IDU 2.5N/3AN/ZB
N/A/5mm	24-16 AWG	1792560000	IPE 1.5
N/A/5mm	24-16 AWG	1792590000	IPE 1.5N/3AN
N/A/5mm	24-16 AWG	1792620000	IPE 1.5 N/4AN
N/A/5mm	24-16 AWG	1792720000	IPE 1.5N/ZF
N/A/5mm	24-16 AWG	1806140000	IPE 1.5N/ZF/3AN
N/A/5mm	24-16 AWG	1792750000	IPE 1.5N/ZB
N/A/5mm	24-16 AWG	1806160000	IPE 1.5N/ZB/3AN
N/A/5mm	24-16 AWG	1792690000	IDK 1.5 N/PE
N/A/5mm	20-14 AWG	1812920000	IPE 2.5N
N/A/6mm	20-14 AWG	1812950000	IPE 2.5N/3AN
N/A/6mm	20-14 AWG	1812980000	IPE 2.5N/4AN
N/A/6mm	20-14 AWG	1821280000	IPE 2.5N/ZF
N/A/6mm	20-14 AWG	1821310000	IPE 2.5N/ZB
N/A/6mm	20-14 AWG	1848320000	IPE 2.5N/3AN/ZB
300V/10A/5mm	24-16 AWG	1792630000	ITR 1.5N *
300V/10A/5mm	24-16 AWG	1812510000	ITR 1.5N/3AN
300V/6.3A/5mm	24-16 AWG	1792640000	ITR 1.5N/SI *
300V/6.3A/5mm	24-16 AWG	1820390000	ITR 1.5N/3AN/SI *
300V/10A/6mm	20-14 AWG	1812990000	ITR 2.5N/ *
300V/6.3A/6mm	20-14 AWG	1813010000	ITR 2.5N/SI *

Terminal Blocks - I Series

End Plate / Partition	End Bracket *	Jumpers (# of poles)	Labels	DIN Rail *	Screwdriver
1792430000	0383560000/9540000000	1908960000 (20)	1635000000	0514500000	9006060000
1792450000	0383560000/9540000000	1908960000 (20)	1635000000	0514500000	9006060000
1792600000	0383560000/9540000000	1908960000 (20)	1635000000	0514500000	9006060000
1792430000	0383560000/9540000000	1908960000 (20)	1635000000	0514500000	9006060000
1792450000	0383560000/9540000000	1908960000 (20)	1635000000	0514500000	9006060000
1792430000	0383560000/9540000000	1908960000 (20)	1635000000	0514500000	9006060000
1792450000	0383560000/9540000000	1908960000 (20)	1635000000	0514500000	9006060000
1792650000	1061200000/9540000000	1908960000 (20)	1635000000	0514500000	9006060000
1813020000	1061200000/9540000000	1609030000 (10)	1828450000	0514500000	9006060000
1813040000	0383560000/9540000000	1609030000 (10)	1828450000	0514500000	9006060000
1813070000	0383560000/9540000000	1609030000 (10)	1828450000	0514500000	9006060000
1813020000	0383560000/9540000000	1609030000 (10)	1828450000	0514500000	9006060000
1813020000	0383560000/9540000000	1609030000 (10)	1828450000	0514500000	9006060000
1813040000	0383560000/9540000000	1609030000 (10)	1828450000	0514500000	9006060000
1792430000	0383560000/9540000000	N/A	1635000000	0514500000	9006060000
1792450000	0383560000/9540000000	N/A	1635000000	0514500000	9006060000
1792470000	0383560000/9540000000	N/A	1635000000	0514500000	9006060000
1792430000	0383560000/9540000000	N/A	1635000000	0514500000	9006060000
1792450000	0383560000/9540000000	N/A	1635000000	0514500000	9006060000
1792430000	0383560000/9540000000	N/A	1635000000	0514500000	9006060000
1792450000	0383560000/9540000000	N/A	1635000000	0514500000	9006060000
1803800000	0383560000/9540000000	N/A	1635000000	0514500000	9006060000
1813020000	0383560000/9540000000	N/A	1828450000	0514500000	9006060000
1813040000	0383560000/9540000000	N/A	1828450000	0514500000	9006060000
1813070000	0383560000/9540000000	N/A	1828450000	0514500000	9006060000
1813020000	0383560000/9540000000	N/A	1828450000	0514500000	9006060000
1813020000	0383560000/9540000000	N/A	1828450000	0514500000	9006060000
1813040000	0383560000/9540000000	N/A	1828450000	0514500000	9006060000
1792450000	0383560000/9540000000	1608940000 (10)	1635000000	0514500000	9006060000
1792470000	0383560000/9540000000	1608940000 (10)	1635000000	0514500000	9006060000
1792450000	0383560000/9540000000	1608940000 (10)	1635000000	0514500000	9006060000
1792470000	0383560000/9540000000	1608940000 (10)	1635000000	0514500000	9006060000
1813040000	0383560000/9540000000	1609030000 (10)	1828450000	0514500000	9006060000
1813020000	0383560000/9540000000	1609030000 (10)	1828450000	0514500000	9006060000

* See page A.16 for details or other options

Terminal Blocks - P Series & Rail Accessories

P Series - Feed Through Terminal Blocks		Ratings/Width	Wire Range	Part Number	Description
 <p>PDU 2.5/4</p>		600V/30/5mm	26-10 AWG	1896110000	PDU 2.5/4
		600V/30/5mm	26-10 AWG	1896120000	PDU 2.5/4 3AN
		600V/30/5mm	26-10 AWG	1896130000	PDU 2.5/4 4AN
P Series - Ground Terminal Blocks		600V/5mm	26-10 AWG	1896170000	PPE 2.5/4
 <p>PPE 2.5/4</p>		600V/5mm	26-10 AWG	1896200000	PPE 2.5/4 3AN
		600V/5mm	26-10 AWG	1896160000	PPE 2.5/4 4AN
Rail Accessories		Solid	M5 Slot	M6 Slot	End Bracket
 <p>TS35 7.5x1.0</p>		TS35x7.5 0383400000	TS35x7.5 0514500000	TS35x7.5 0676200000	EW35 0383560000
					WEW/2 1061200000
					WEW35/1 1059000000
					ZEW TS35 9540000000
					ZEW 35/2 8630740000
 <p>TS35 15x1.5</p>		TS35x15 023640000	TS35x15 023650000		EW35 0383560000
					WEW/2 1061200000
					WEW35/1 1059000000
					ZEW TS35 9540000000
					ZEW 35/2 8630740000
 <p>TS35 15x2.3</p>		TS35x15 0498000000			EW35 0383560000
					WEW/2 1061200000
					WEW35/1 1059000000
					ZEW TS35 9540000000
					ZEW 35/2 8630740000
 <p>TS32</p>		TS32 0122800000	TS32 0514400000	TS32 0676100000	EWK1 0206160000
					EWK2 0199360000
					WEW32/1 1067600000
					EWK 0495160000

Terminal Blocks - P Series & Rail Accessories

End Plate / Partition	End Bracket *	Jumpers (# of poles)	Labels	DIN Rail *	Screwdriver
1896300000	9540000000	1908960000 (20)	1635000000	0514500000	9008320000
1896480000	9540000000	1908960000 (20)	1635000000	0514500000	9008320000
1896320000	9540000000	1908960000 (20)	1635000000	0514500000	9008320000
1896300000	9540000000	N/A	1635000000	0514500000	9008320000
1896480000	9540000000	N/A	1635000000	0514500000	9008320000
1896320000	9540000000	N/A	1635000000	0514500000	9008320000

Terminal Blocks

A

Mounting Bases



Description	Part Number
FM 4 (M4) TS 35	0687900000
FM 5 (M5) TS35	0636800000
FM 6 (M6) TS35	0636900000

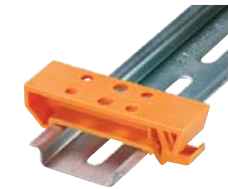

Description	Part Number
MOFU 35/LO/1	0646260000

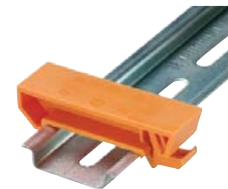

Description	Part Number
MOFU 35	0495660000



Description	Part Number
MB M3/M5 TS32	0503500000
MB M5/M3 TS32	0553400000
MB M6/M4 TS32	0334900000

Rail Support - straight

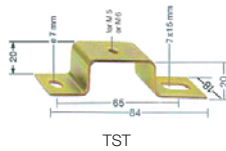
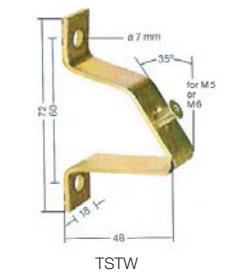

Rail Support - straight

TST 2/M5	1286600000
TST 2/M6	0101700000
TST 30mm	7924270030
TST 40mm	7924270040
TST 50mm	7924270050
TST 70mm	7924270070
TST 90mm	7924270090

Rail Support - angled

TSTW 5/M5	01781035000
TSTW 5/M6	1779103500
TSTW 6/M6	0164003500
TSTW 49mm	7924273549
TSTW 58mm	7924273558
TSTW 68mm	7924273568
TSTW 78mm	7924273578
TSTW 88mm	7924273588
TSTW 98mm	7924273598

Rail Support - screws







FKSC M5X8	0295900000
FKSC M6X8	0642600000
FKSC M6X12	0353500000

SH 1 TS 15 compl.	0299860000
SH 1 socket	0401460000
SH 1 yoke	0635900000
SH 2 TS 32/35	0494920000
SH 2 S	0641720000

SchT5	0292460000
ESO 5 white	1607710000
STR5	0294000000
SchT5S	1631930000
ESO5S white	1631920000
STR5S	1631940000

* See page A.16 for details or other options

Accessories - End Brackets

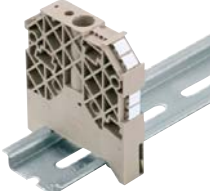
	Fits on	Width	Part Number	Description
 EWK 1	TS32	8.5mm	0206160000	EWK1
 EWK 1 ALT	TS32	12.2mm	0495160000	EWK 1 ALT
 EWK 2	TS32	8mm	0199360000	EWK 2
 EW 35	TS35	8.5mm	0383560000	EW 35
 WEW 35/2	TS35	8mm	1061200000	WEW 35/2
 ZEW 35/2	TS35	8mm	9540000000 8630740000	ZEW 35 ZEW 35/2
 WEW 35/1	TS35	12.2mm	1059000000	WEW35/1

Circuit Breakers

Circuit Breakers

Branch Circuit Protectors	B.2
Supplementary Circuit Breakers 91H Series	B.2
Supplementary Circuit Breakers 2210 Series	B.3
Supplementary Circuit Breakers 4201 Series	B.4

Circuit Breakers

Branch Circuit Protectors



1 and 2 pole versions available (AC version only)
 TS 35 DIN rail mountable
 10KA interrupting capacity
 CSA22.2 No.5.02, UL 489
 120Vac single pole/240Vac double pole 50/60Hz
 80Vdc single pole version

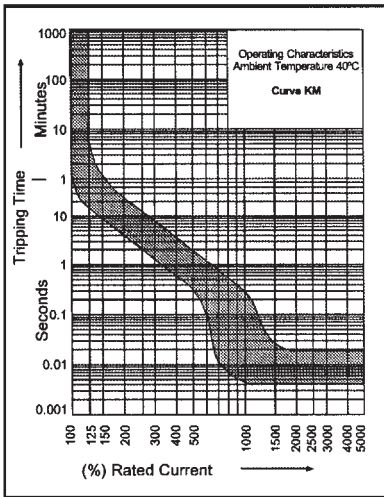

KM Trip Curve

Accessories:
 Lockout piece QFAP001
 Busbar SABBM54

AC Current/Internal Resistance	Part Number 1 Pole/120Vac	Part Number 2 Pole/240Vac
1amp / 1.36ohms	9926251001	9926252001
2 amp / 0.297ohms	9926251002	9926252002
5amp / 0.039ohms	9926251005	9926252005
10amp / 0.014ohms	9926251010	9926252010
15amp / 0.07ohms	9926251015	9926252015
20amp / 0.006ohms	9926251020	9926252020
25amp / 0.0042ohms	9926251025	9926252025

DC Current/Internal Resistance	Part Number 1 Pole/80Vdc
1amp / 1.18ohms	9926251901
2 amp / 0.266ohms	9926251902
5amp / 0.0388ohms	9926251905
10amp / 0.0136ohms	9926251910
15amp / 0.0067ohms	9926251915
20amp / 0.0058ohms	9926251920
25amp / 0.004ohms	9926251925
30amp / 0.0028ohms	9926251930
35amp / 0.0024ohms	9926251935
40amp / 0.0023ohms	9926251940
45amp / 0.0023ohms	9926251945
50amp / 0.0023ohms	9926251950
55amp / 0.0023ohms	9926251955
60amp / 0.0023ohms	9926251960

Circuit Breakers

Supplementary Circuit Breakers 91H Series



1,2,3 poles versions available
 TS 35 rail mountable
 Optional Auxiliary contact
 UL and CSA approvals
 CSA277Vac (1 pole) or 480Vac (2&3 pole)
 50 Vdc (0.5A to 50A) 1 pole
 110 Vdc (0.5 to 50A) 2 pole

Accessories:
 Aux. Contacts
 E901001 (1C0)
 Y30415301 3 phase busbar
 Y30415701 single phase busbar
 Y30484501 Lockout piece

Current / Internal Resistance	Part Number 1 Pole	Part Number 2 Pole	Part Number 3 Pole
0.5amp / 6.20ohms	9925350000	9925650000	9925810000
1.0amp / 1.70ohms	9925360000	9925660000	9925820000
2.0amp / 0.45ohms	9925380000	9925680000	9925840000
3.0amp / 0.22ohms	9925390000	9925690000	9925850000
4.0amp / 0.125ohms	9925400000	9925700000	9925860000
6.0amp / 0.05ohms	9925410000	0025710000	9925870000
10.0amp / <0.02ohms	9925430000	9925710000	9925890000
13.0amp / <0.02ohms	9929820000	9929830000	9929840000
16.0amp / <0.02ohms	9925440000	9925740000	9925900000
20.0amp / <0.02ohms	9925450000	9925750000	9925910000
25.0amp / <0.02ohms	9925460000	9925760000	9925920000
32.0amp / <0.02ohms	9925470000	9925770000	9925930000
40.0amp / <0.02ohms	9925480000	9925780000	9925940000
50.0amp / <0.02ohms	9925490000	9925790000	9925950000
63.0amp / <0.02ohms	9925500000	9925800000	9925960000

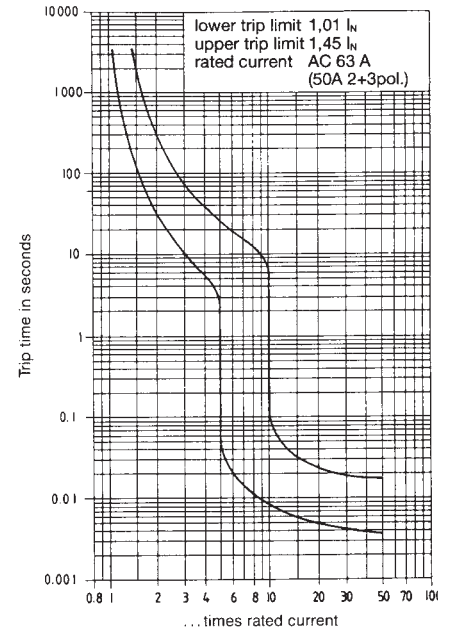
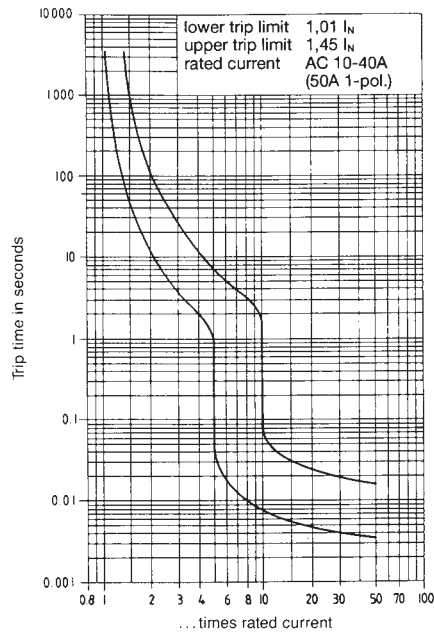
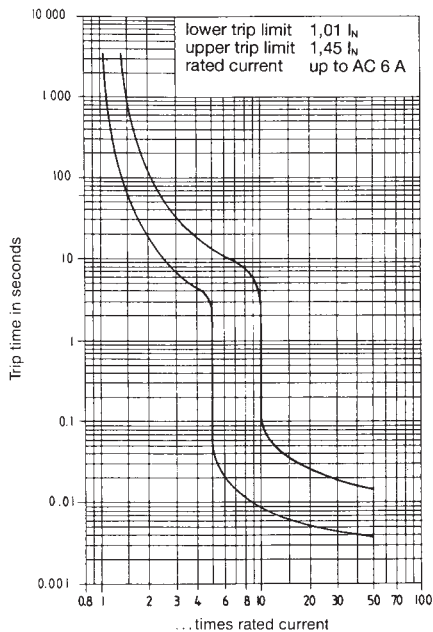

(multipole types: all poles symmetrically loaded)

Circuit Breakers

Supplementary Circuit Breakers 2210 Series



1,2,3 pole versions available
 TS 35 and TS32 DIN rail mountable
 CSA, UL, VDE approvals
 250Vac (0.1 to 32A)
 65Vdc (0.1 to 32A)

0.1 to 5A 400A interrupting capacity
 6 to 16A 800A interrupting capacity
 20A 1000A at AC, 800A at DC interrupting capacity

Current / Internal Resistance	Part Number 1 Pole	Part Number 2 Pole	Part Number 3 Pole
0.1amp / 92ohms	9911010000	9912010000	9913010000
0.2amp / 26.1ohms	9911020000	9912020000	9913020000
0.3amp / 11.6ohms	9911030000	9912030000	9913030000
0.4amp / 6.6ohms	9911040000	9912040000	9913040000
0.5amp / 4.1ohms	9911050000	9912050000	9913050000
0.6amp / 3ohms	9911060000	9912060000	9913060000
0.8amp / 1.65ohms	9911080000	9912080000	9913080000
1.0amp / 1.1ohms	9911100000	9912100000	9913100000
1.5amp / 0.47ohms	9911150000	9912150000	9913150000
2.0amp / 0.28ohms	9911200000	9912200000	9913200000
2.5amp / 0.18ohms	9911250000	9912250000	9913250000
3.0amp / 0.12ohms	9911300000	9912300000	9913300000
4.0amp / 0.08ohms	9911400000	9912400000	9913400000
5.0amp / 0.06ohms	9911500000	9912500000	9913500000
6.0amp / 0.04ohms	9911600000	9912600000	9913600000
8.0amp / 0.02ohms	9911800000	9912800000	9913800000
10.0amp / 0.01ohms	9921100000	9922100000	9923100000
12.0amp / 0.01ohms	9921120000	9922120000	9923120000
15.0amp / 0.01ohms	9921150000	9922150000	9923150000
16.0amp / <0.01ohms	9921160000	9922160000	9923160000
18.0amp / <0.01ohms	9921180000	9922180000	9923180000
20.0amp / <0.01ohms	9921200000	9922200000	9923200000
25.0amp / <0.01ohms	9921250000	9922250000	9923250000
32.0amp / <0.01ohms	9921320000	9922320000	9923320000

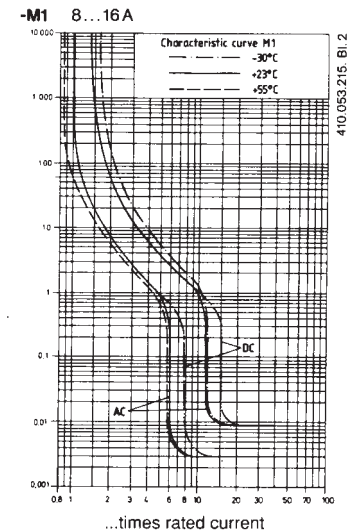
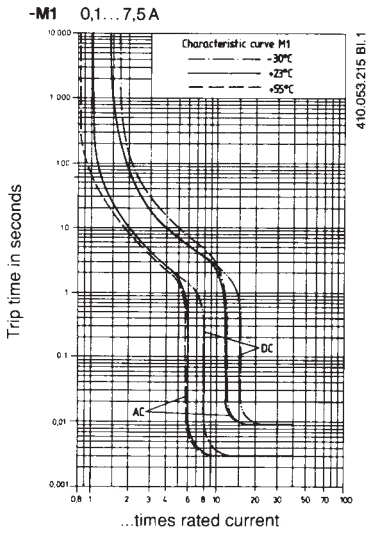

Supplementary Circuit Breakers 4201 Series



1,2 pole versions available
 TS 35 and TS32 DIN rail mountable (with adaptor)
 CSA, UL, VDE approvals
 250Vac (0.05 to 16A)
 65Vdc (0.05 to 16A)

0.05 to 2A 100x rated current or
 200A max. interrupting capacity
 2.0 to 16A 200A max. interrupting capacity
 20A max. 400A interrupting capacity

Typical time/current Characteristics

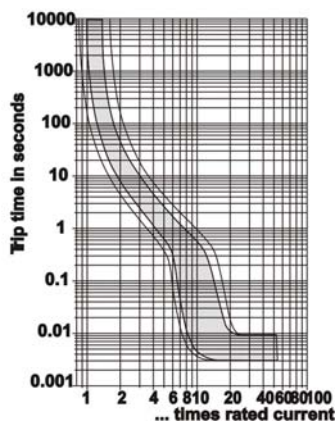
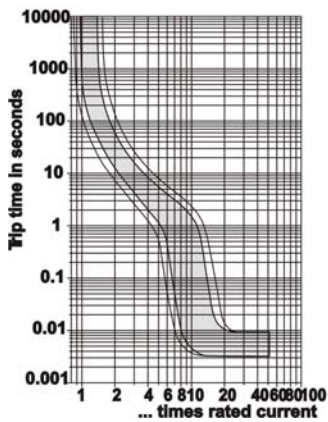

Adaptor foot
 9102100000

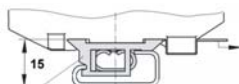

Current / Internal Resistance	Part Number 1 Pole	Part Number 2 Pole
0.05amp / 447ohms	9124080000	9124220000
0.08amp / 220ohms	9104650000	9124230000
0.1amp / 131ohms	9104170000	9120350000
0.2amp / 40ohms	9104180000	9124240000
0.3amp / 19.3ohms	9129810000	9124260000
0.4amp / 10.4ohms	9124090000	9124270000
0.5amp / 7.1ohms	9101000000	9129580000
0.6amp / 4.3ohms	9124110000	9124280000
0.7amp / 3.57ohms	9129560000	9124290000
0.8amp / 2.5ohms	9101100000	9129590000
1.0amp / 1.67ohms	9101200000	9129610000
1.2amp / 1.22ohms	9101300000	9129620000
1.3amps / 1.08ohms	9124120000	9124310000
1.4amps / 1.0ohms	9124130000	9124320000
1.5amps / 0.61ohms	9101400000	9129630000
1.8amps / 0.56ohms	9124140000	9124330000
2.0amps / 0.38ohms	9101500000	9129640000
2.5amps / 0.24ohms	9101600000	9129650000
3.0amps / 0.19ohms	9101700000	9129660000
3.5amps / 0.14ohms	9124160000	9124340000
4.0amps / 0.090ohms	9104350000	9129710000
4.5amps / 0.090ohms	9124170000	9124350000
5.0amps / 0.061ohms	9101800000	9129670000
5.5amps / 0.07ohms	9107830000	9124360000
6.0amps / 0.041ohms	9103810000	9124370000
6.5amps / 0.46ohms	9120040000	9124380000
7.0amps / 0.034ohms	9104150000	9124390000
8.0amps / <0.02ohms	9103000000	9104670000
9.0amps / <0.02ohms	9104610000	9124420000
10.0amps / <0.02ohms	9101900000	9129680000
11.0amps / <0.02ohms	9124180000	9124430000
12.0amps / <0.02ohms	9107840000	9124440000
13.0amps / <0.02ohms	9124190000	9124450000
14.0amps / <0.02ohms	9107850000	9124460000
15.0amps / <0.02ohms	9102000000	9129690000
16.0amps / <0.02ohms	9124210000	9124470000

Notes

B

Heavy Duty Connectors

Heavy Duty Connectors

Heavy Duty Connector Kits

C.2

Heavy Duty Connectors - Kits

Number of Poles	Specifications	Version 1	Version 2	Version 3
HA-3 Group Size 1	Voltage / Current	Screw / Side	Screw / Top	Screw / Side DSTV
 1498100000  1498200000	600V / 10A	1712580000 PG11/P METAL	1712560000 PG11/P METAL	
	600V / 10A	1712630000 PG11/P PLASTIC	1712570000 PG11/P PLASTIC	
	600V / 10A	1802450000 M20G METAL	1802470000 M20G METAL	
	600V / 10A		1802460000 M20G PLASTIC	
 1498300000  1498400000	600V / 16A	1712590000 PG11/P METAL	1712610000 PG11/P METAL	
	600V / 16A	1712600000 PG11/P PLASTIC	1712650000 PG11/P PLASTIC	
	600V / 16A	1802440000 M20G METAL	1802700000 M20 METAL	
	600V / 16A	1802430000 M20G PLASTIC		
 1200000000  1200020000	600V / 16A	1712460000 PG16/P METAL	1712660000 PG16/P METAL	1712700000 PG16/P METAL
	600V / 16A	1802730000 M20 METAL	1802740000 M20 METAL	
 1203900000  1204100000	600V / 16A	1712510000 PG16/P METAL	1712670000 PG 16/P METAL	1712710000 PG16/P METAL
	600V / 16A	1802420000 M25 METAL	1802410000 M25 METAL	
	600V / 16A	1763870000 NPT1/2" METAL	1763910000 NPT1/2" METAL	
 1207500000  1207700000	600V / 16A	1712520000 PG21/P METAL	1712680000 PG21/P METAL	1712720000 PG21/P METAL
	600V / 16A	1802400000 M25 METAL	1802390000 M25 METAL	
	600V / 16A	1763860000 NPT3/4" METAL	1763920000 NPT3/4" METAL	
 1211100000  1211300000	600V / 16A	1712530000 PG21/P METAL	1712690000 PG21/P METAL	1712730000 PG21/P METAL
	600V / 16A	1802380000 M32 METAL	1802480000 M32 METAL	
	600V / 16A	1763890000 NPT3/4" METAL	1763930000 NPT3/4" METAL	
 1207500000+1215700000  1207700000+1216100000	600V / 16A	1712540000 PG29/P METAL		
	600V / 16A	1802370000 M32 METAL		
	600V / 16A	1763900000 NPT1" METAL		
 1211100000+1220800000  1211300000+1221200000	600V / 16A	1712550000 PG29/P METAL		
	600V / 16A	1802360000 M40 METAL		
 1498700000  1498900000	600V / 35A	1724000000 PG21/P METAL		

Electronics

Electronics

Interface Modules	D.2
DIN Rail Mountable Outlets	D.4
Non-Incendive Barriers	D.5
Instrumentation Make-before-break Terminals	D.5
Relays	D.6
Optocouplers	D.10
Delcon Pulse Transformer Modules	D.14
Analog Signal Conditioners	D.18
Power Supplies	D.26

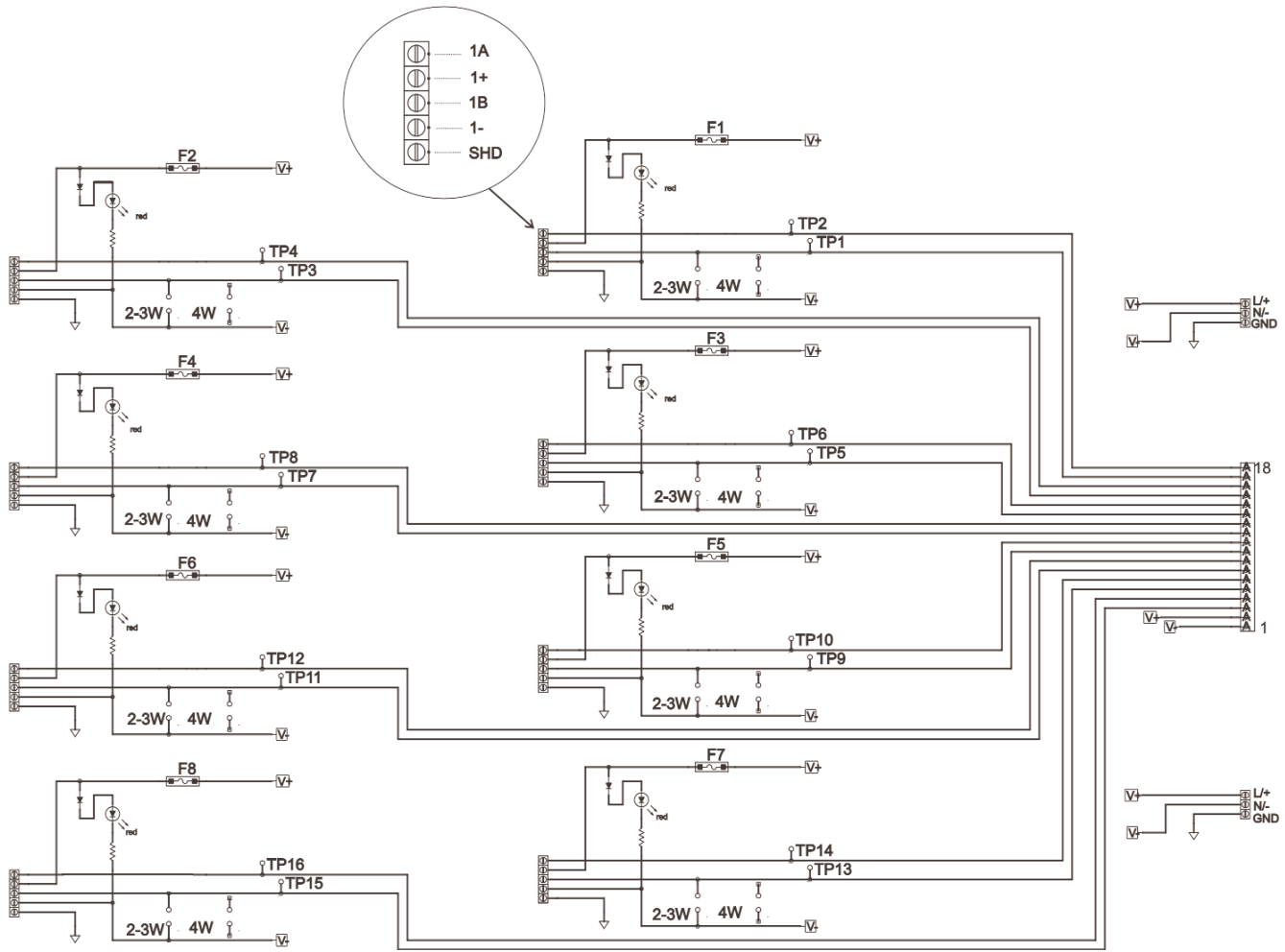

Sample wiring diagram for Universal QUICKbloc

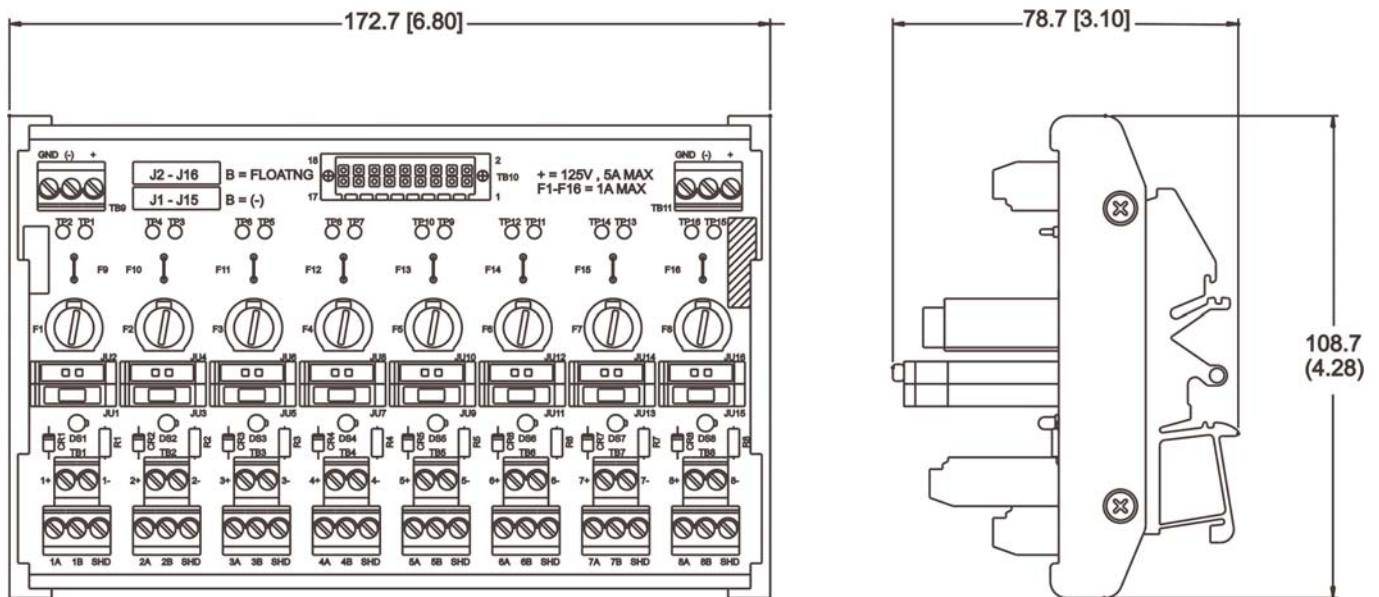

Universal QUICKbloc

Electronics - Interface Modules

RSF Poles/Dimensions

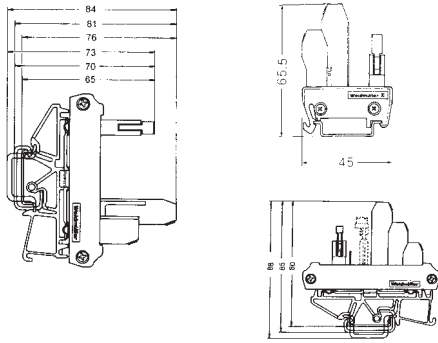

# of Poles	Width
10	50.00mm
14	50.00mm
20	65.00mm
34	110.00mm
40	115.00mm

RSF (2 Tier Compact)



RSF (2 Tier)



RSF (3 Tier)



Connection Type (Control)	Ribbon cable connector to DIN 41651	Ribbon cable connector to DIN 41651	Ribbon cable connector to DIN 41651
Connection Type (Field)	Screw Connection (AWG 26-14)	Screw Connection (AWG 26-14)	Screw Connection (AWG 26-14)
Voltage	60Vac, 75Vdc	60Vac, 75Vdc	60Vac, 75Vdc
Current per contact	1A	1A	1A
Cross-Section	2.5mm ²	2.5mm ²	2.5mm ²
Ambient Temperature	0°C to +55°C	0°C to +55°C	0°C to +55°C
Mounting Options	TS32 / TS35	TS32 / TS35	TS32 / TS35
Approvals	CE	SP CE	CE
Part Number	10 Pole - 8155610000 14 Pole - 8258980000 20 Pole - 8155600000 34 Pole - 8155590000 40 Pole - 8155580000	10 Pole - 0224961001 14 Pole - 0225061001 20 Pole - 0224261001 34 Pole - 0224361001 40 Pole - 0224461001	10 Pole - 8012850000 14 Pole - 8012860000 20 Pole - 8012910000 34 Pole - 8012930000 40 Pole - 8012940000

Other pole counts available on request

RSSD Poles/Dimensions

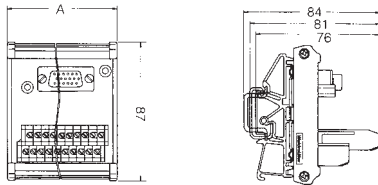

# of Poles	Width
9	40.00mm
15	60.00mm
25	80.00mm
37	110.00mm
50	145.00mm

RSSD S



RSSD B













Universal QuickBLOC











Connection Type (Control)	Male D-Sub connector to DIN 41 652	Female D-Sub connector to DIN 41 652	18 pole male S2L withlocking screws
Connection Type (Field)	Screw Connection (AWG 26-14)	Screw Connection (AWG 26-14)	Screw Connection (AWG26-12)
Voltage	125Vac, 150Vdc	125Vac, 150Vdc	125Vmax
Current per contact	1.5A	1.5A	5A (supply); 1A (signal box)
Cross-Section	0.5 - 2.5mm ²	0.5 - 2.5mm ²	0.5 - 4mm ²
Ambient Temperature	0°C to +55°C	0°C to +55°C	0°C to +55°C
Mounting Options	TS32 / TS35	TS32 / TS35	TS32 / TS35
Approvals	SP CE	SP CE	SP
Part Number	9 Pole - 8003901001 15 Pole - 8005201001 25 Pole - 8005181001 37 Pole - 8003881001 50 Pole - 8005161001	9 Pole - 8003911001 15 Pole - 8005211001 25 Pole - 8005191001 37 Pole - 8003891001 50 Pole - 8005171001	16 ch w/ 1 fuse - 7940000602 16 ch w/ 2 fuses - 7940000604 cable 2m - - 7940000628 *

* contact factory for other lengths

Electronics - DIN Rail Mountable Outlets

	120Vac Single w/ Breaker	120Vac Duplex	230Vac Single		
					
Input Voltage	120Vac	120Vac	230Vac		
Rated Current	5A max via outlet 10A via redundant terminals	15A max	16A		
Breaker interrupting capacity	1kA	-	-		
Terminations	Side Entry LP 5.08	Side Entry LP 5.08	Side Entry Molded screw connections		
Wire Range	26-12AWG (0.14-4.0mm ²)	26-12AWG (0.14-4.0mm ²)	14AWG (1.5mm ²)		
Dimensions (LxWxH)	70 x 35 x 55mm	70 x 75 x 48mm	76 x 45 x 60mm		
Mounting Options	TS32  / TS35 	TS32  / TS35 	TS35 		
Part Number	9915480001	9915490000	8734580000		
Type	RS-AC/CB 120Vac	RS-DUPLEX 120Vac	AC OUTLET EUROPEAN		
Approvals	 LR-229352, UL E252394	 LR-82859, UR E141197			

	120Vac GFI Outlet	120Vac Duplex			DIN Rail Mountable Drawer
					
Input Voltage	120Vac	120Vac			-
Rated Current	15A max.	15A via Duplex 20A via Terminals			-
Terminations	Top Entry, Tension Clamp LPZF	Side Entry, screw clamp (LLP 6.35)			-
Wire Range	26-14AWG (0.14-6.0mm ²)	26-14AWG (0.14-6.0mm ²)			-
Dimensions (LxWxH)	95 x 130 x 67mm	95 x 130 x 67mm			54.5 x 54.5 x 80.8mm
Mounting Options	TS35  / opt. direct mount	TS35  / opt. direct mount			TS35 
Part Number	7940000037	7940000036			7914760001
Type	GFI Outlet, 15A	GFI Outlet, 20A			DIN Rail Mountable Utility Box
Approvals	 LR-82859, UR E232318	 LR-82859, UR E232318			-
Notes	Direct mounting kit - 7920560000	Direct mounting kit - 7920560000			Can be mounted on horizontal or vertical rails

Electronics - Non-Incendive Barriers and Make-before-break Terminals

Digital Non-Incendive Barrier



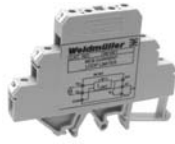

Analogue Current Limiter



Rated Voltage	24Vdc	24Vdc		
Rated Current	51.1mA	20mA		
Max. Voltage	35Vdc	24Vdc (2.5Vdc drop max)		
Max. Current	75mA	24mA		
Output Alarm	-	24Vdc @50mA transistor output		
Status Led	-	Red LED (ON indicates Fault)		
Wire Size	22-12AWG	22-12AWG		
Mounting Options	TS32  / TS35 	TS32  / TS35 		
Dimensions (LxWxH)	88.4 x 12 x 68.2mm	88.4 x 9.5 x 68.2mm		
Part Number	9916290000	9918010000		
Description	MC6 Non-Incendive Barrier Digital	MC6 Non-Incendive Barrier Analogue		
Approvals	 Class 1, Division 2, Groups A, B, C & D, T3C (160°C)	 Class 1, Division 2, Groups A, B, C & D, T3C (160°C)		

MC6 Instrumentation Terminal



Voltage	30Vdc		
Current	25mA max.		
Wire Size	22-12AWG		
Moulding Material	polyamid 6.6, UL94-V2		
Temperature Rating	0-60deg C.		
Meter Connection	1/8" phono jack (see accessories)		
Mounting Options	TS32  / TS35 		
Dimensions	89 x 9.5 x 68mm		
Part Number	9917841000		
Description	MC6 MBB-INS		
Accessories	Endplate - C9040396 Test Leads - 9917851000		

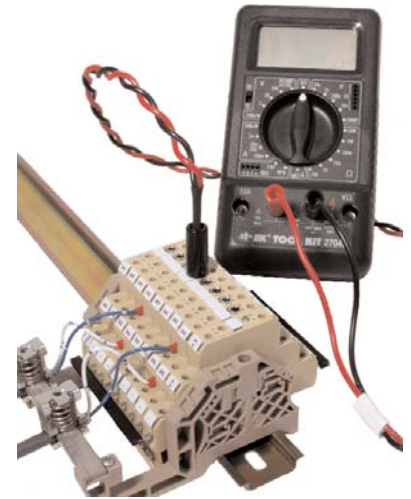

Picture Shows MC6 MBB-INS and Test Leads

Electronics - Relays

PicoPak DK4/5

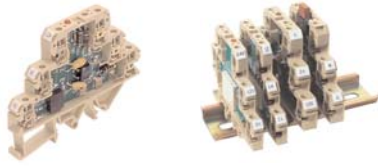

Accessories	Description	Part Number
End plate	AP DK4	0687560000
	AP DK5	C9039986
Jumper		
Comb Insulated	2 Pole - QB2	0482700000
	3 Pole - QB3	0482800000
	4 Pole - QB4	0482900000
Jumper Comb		
Uninsulated	75 Pole straight QB75	0535200000
	75 Pole angled QB75	0526400000
Insulating cover strip	75 Pole IP75	0526700000
Marking Tag		
	Blank - White DEK5/6	1609820000

MicroSeries



Accessories	Description	Part Number
Pluggable jumpers*		
	2 Pole Red ZQV 4N / 2 RT	1793950000
	3 Pole Red ZQV 4N / 3 RT	1793980000
	41 Pole Red ZQV 4N / 41 RT	1794070000
	2 Pole Black ZQV 4N / 2 SW	1793970000
	3 Pole Black ZQV 4N / 3 SW	1794000000
	41 Pole Black ZQV 4N / 41 SW	1794090000
	2 Pole Blue ZQV 4N / 2 BL	1793960000
	3 Pole Blue ZQV 4N / 3 BL	1793990000
	41 Pole Blue ZQV 4N / 41 BL	1794080000
Marking Tag		
	Blank - White WS 12/6	1609900000

*other colours and pole counts also available

MCZ



Accessories	Description	Part Number
Endplate	ZAP	8389030000
Pluggable Jumpers		
	4 Pole - ZQV4/4	1608970000
	10 Pole - ZQV4/10	1609030000
Marking Tag		
	Blank - White DEK5/6	1609820000

Input	Output Configuration	Max Contact Rating	Part Number
5Vdc	1CO (SPDT)	6A@24Vdc 4A@120Vac	8556080000 8556150000
5-15V logic (24Vdc aux.)	NO (Normally Open)	4A@30Vdc 4A@250Vac	7901580000
5-15V logic (24Vdc aux.)	NO (Normally Open)	4A@30Vdc 4A@250Vac	7901590000
12Vdc	1CO (SPDT)	6A@24Vdc 4A@120Vac	8556070000 8556140000
12Vdc	1CO (SPDT)	6A@24Vdc 4A@120Vac	7940004779 7940004780
12Vdc	2CO (DPDT)	5A @ 224 Vdc 5A @ 120Vdc	330075
12Vdc	1CO (SPDT)	10A@24Vdc 10A@120Vac	8536471001 8536571001
12Vdc	2CO (DPDT)	10A@24Vdc 10A@120Vac	8536501001 8536591001
12Vdc (24Vdc)	NO (Normally Open)	4A@30Vdc 4A@250Vac	7901540000
12Vac/dc (24Vac/dc)	NO (Normally Open)	4A@30Vdc 4A@250Vac	7901560000
24Vdc	1CO (SPDT)	5A@30Vdc 5A@250Vac	7901620000
24Vdc	1CO (SPDT)	6A@24Vdc 4A@120Vac	8533640000 8533660000
24Vdc	1CO (SPDT)	6A@24Vdc 4A@120Vac	7940004781 7940004782
24Vdc	1CO (SPDT)	6A@24Vdc 4A@120Vac	8596060000 8596080000
24Vdc	NO (Normally Open)	5A@24Vdc (fused) 5A@120Vac (fused)	7923450024
24Vdc	1CO (SPDT)	4A@30Vdc 4A@250Vac	37SM400F
24Vdc	1CO (SPDT)	6A@24Vdc 4A@120Vac	8660920000 8660910000
24Vdc	- Only NU contact used	10A@24Vdc 10A@120Vac	8530621001 8530691001
24Vdc	NO (Normally Open)	6A@30Vdc 5A@250Vac	1101611001
24Vdc	NC (Normally Closed)	6A@30Vdc 5A@250Vac	1100911001
24Vdc	1CO (SPDT)	6A@30Vdc 5A@250Vac	1100210000
24Vdc	2CO (DPDT)	10A@24Vdc 10A@120Vac	8530631001 8530701001
24Vdc	4CO (4PDT)	6A@24Vdc 5A@120Vac	7940007063 8798740000
24Vac/dc	1CO (SPDT)	6A@24Vdc 4A@120Vac	8556050000 8556120000
24Vac/dc	NO (Normally Open)	10A@24Vdc 10A@120Vac 3.5A@125Vdc	9906310000

Note: VUC = Vac/dc on all pages for relays/optos

Description	Connection Type	Dimensions (LxWxH)	Accessories	Notes / Features	Approvals
MRS 5Vdc 1CO MRZ 5Vdc 1CO	Screw Clamp Tension Clamp	MicroSeries 93x6.1x92mm MicroSeries 94x6.1x91mm	see Accessories for MicroSeries	Replacement Relay - 4061580000	CSA, cULus, CE
MC5RL 5-15VIN/AUX	Screw Clamp	PicoPak 78x6x63mm	see Accessories for DK4/5	-	CSA, cURrs, CE
MC5RL 5-15L LOGIC	Screw Clamp	PicoPak 78x6x63mm	see Accessories for DK4/5	-	CSA, cURrs, CE
MRS 12Vdc 1CO MRZ 12Vdc 1CO	Screw Clamp Tension Clamp	MicroSeries 93x6.1x92mm MicroSeries 94x6.1x91mm	see Accessories for MicroSeries	Replacement Relay - 4061610000	CSA, cULus, CE
MRS 12Vdc 1CO C1D2 MRZ 12Vdc 1CO C1D2	Screw Clamp Tension Clamp	MicroSeries 93x6.1x92mm MicroSeries 94x6.1x91mm	see Accessories for MicroSeries	Non-replacable Relay	CSA, cULus, CE, CSA C1D2
RS70 12Vdc 2CO C1D2	Screw Clamp	Rider Series 70x20.1x57.3mm	-	-	CSA C1D2
PRS 12Vdc LD 1CO PRZ 12Vdc LD 1CO	Screw Clamp Tension Clamp	PlugSeries 92x15.3x95mm PlugSeries 92x15.3x87mm	see Accessories for PlugSeries	Replacement Relay - 4058470000	CSA, cURus, CE
PRS 12Vdc LD 2CO PRZ 12Vdc LD 2CO	Screw Clamp Tension Clamp	PlugSeries 92x15.3x95mm PlugSeries 92x15.3x87mm	see Accessories for PlugSeries	Replacement Relay - 4058560000	CSA, cURus, CE
MC5R 12V/24VDC	Screw Clamp	PicoPak 78x6x63mm	see Accessories for DK4/5	-	CSA, cURrs, CE, CSA C1D2
MC5R 12/24VAC/DC	Screw Clamp	PicoPak 78x6x63mm	see Accessories for DK4/5	-	CSA, cURrs, CE
MC5R 24VDC 1CO	Screw Clamp	PicoPak 78x6x63mm	see Accessories for DK4/5	-	CSA, cURrs, CE
MRS 24Vdc 1CO MRZ 24Vdc 1CO	Screw Clamp Tension Clamp	MicroSeries 93x6.1x92mm MicroSeries 94x6.1x91mm	see Accessories for MicroSeries	Replacement Relay - 4060120000	CSA, cULus, CE
MRS 24Vdc 1CO C1D2 MRZ 24Vdc 1CO C1D2	Screw Clamp Tension Clamp	MicroSeries 93x6.1x92mm MicroSeries 94x6.1x91mm	see Accessories for MicroSeries	Non-replacable Relay	CSA, cULus, CE, CSA C1D2
MRS 24Vdc 1CO Au MRZ 24Vdc 1CO Au	Screw Clamp Tension Clamp	MicroSeries 93x6.1x92mm MicroSeries 94x6.1x91mm	see Accessories for MicroSeries	Replacement Relay - 4061590000 (Gold Plated Contacts)	cULus, CE
MC6RF 24VUC	Screw Clamp	PicoPak 89x8x71mm	Endplate - C9040396	Ouput fused @ 5A Fuse:- Wickmann type TE5	CSA
RSHV-Fused	Screw Clamp	RS70 70x16x74mm	-	Ouput fused @ 4A Fuse:- Wickmann TR5-F 19370K	CSA, CE
MRS 24Vdc ACT MRZ 24Vdc ACT	Screw Clamp Tension Clamp	MicroSeries 93x6.1x92mm MicroSeries 94x6.1x91mm	see Accessories for MicroSeries	Replacement Relay - 4060120000	cURus, CE
PRS 24Vdc LD 1CO PRZ 24Vdc LD 1CO	Screw Clamp Tension Clamp	PlugSeries 92x15.3x95mm PlugSeries 92x15.3x87mm	see Accessories for PlugSeries	Replacement Relay - 4058480000	CSA, cURus, CE
RS 30 24Vdc, NO GN	Screw Clamp	RS30 74x11.2x51.5mm	-	-	CSA, CE
RS 30 24Vdc, NC GN	Screw Clamp	RS30 74x11.2x51.5mm	-	-	CSA, CE
RS 30 24Vdc, 1CO	Screw Clamp	RS30 74x11.2x51.5mm	-	Pluggable BL/SL	CSA, CE
PRS 24Vdc LD 2CO PRZ 24Vdc LD 2CO	Screw Clamp Tension Clamp	PlugSeries 92x15.3x95mm PlugSeries 92x15.3x87mm	see Accessories for PlugSeries	Replacement Relay - 4058570000	CSA, cURus, CE
RCMKIT 24Vdc 4CO LED GN RCMKITZ 24Vdc 4CO LED GN	Screw Clamp Tension Clamp	RiderSeries 75x27x82mm RiderSeries 96x31x60mm	-	Replacement Relay - 8690200000	cURus, CE
MRS 24Vuc 1CO MRZ 24Vuc 1CO	Screw Clamp Tension Clamp	MicroSeries 93x6.1x92mm MicroSeries 94x6.1x91mm	see Accessories for MicroSeries	Replacement Relay - 4060120000	CSA, cULus, CE
HVDC 24VAC/DC	Screw Clamp	RS HVDC 70x40x100mm	-	Uses 3PST relay contacts in series	CSA

Electronics - Relays

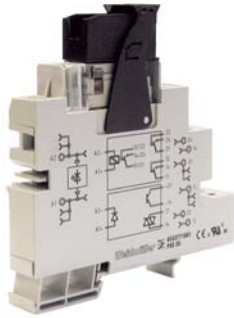

** relay shown with optional blocker (sold separately)

Plug Series	Input	Output Configuration	Max Contact Rating	Part Number
	24Vdc (48Vdc)	NO (Normally Open)	4A@30Vdc 4A@250Vac	7901550000
	24Vac/dc (48Vac/dc)	NO (Normally Open)	4A@30Vdc 4A@250Vac	7901570000
	24Vdc (120Vac)	1CO (SPDT)	2A@30Vdc 0.5A@120Vdc	9910590000
	24Vac	1CO (SPDT)	10A@24Vdc 10A@120Vac	8536530000 8536651001
	24Vac	2CO (DPDT)	10A@24Vdc 10A@120Vac	8536560000 8536681001
	48Vac/dc	1CO (SPDT)	6A@24Vdc 4A@120Vac	8556040000 8556110000
	60Vdc	1CO (SPDT)	6A@24Vdc 4A@120Vac	8556060000 8556130000
	115Vdc	1CO (SPDT)	10A@24Vdc 10A@120Vac	8536510000 8536610000
	115Vdc	2CO (DPDT)	10A@24Vdc 10A@120Vac	8536520000 8536630000
	115Vac	NO (Normally Open)	4A@30Vdc 4A@250Vac	7901600000
115Vac	NO (Normally Open)	6A@30Vdc 5A@250Vac	1102111001	
120Vac	1CO (SPDT)	5A@30Vdc 5A@250Vac	9902860000	
120Vac	NO (Normally Open)	5A@24Vdc (fused) 5A@120Vac (fused)	7923450120	
120Vdc	1CO (SPDT)	6A@24Vdc 4A@120Vac	8556030000 8556100000	
120Vac	1CO (SPDT)	6A@24Vdc 4A@120Vac	8825970000 8825960000	
120Vac/dc	1CO (SPDT)	6A@24Vdc 4A@120Vac	7940004783 7940004784	
120Vac	1CO (SPDT)	6A@24Vdc 4A@120Vac	8652030000 8652040000	
120Vac	1CO (SPDT)	6A@24Vdc 4A@120Vdc	7940023882* 7940023881*	
120Vac	1CO (SPDT)	10A@24Vdc 10A@120Vac	8530641001 8530710000	
120Vac	2CO (DPDT)	10A@24Vdc 10A@120Vac	8530661001 8530720000	
120Vac	4CO (4PDT)	6A@24Vdc 5A@120Vac	8810150000 8810080000	
230Vac	1CO (SPDT)	6A@24Vdc 4A@120Vac	8596050000 8596070000	
230Vac	1CO (SPDT)	6A@24Vdc 4A@120Vac	8556020000 8556090000	
230Vac	2CO (DPDT)	10A@24Vdc 10A@120Vac	8530681001 8530741001	
230Vac	1CO (SPDT)	10A@24Vdc 10A@120Vac	8530671001 8530731001	

Accessories	Description	Part Number
Pluggable Jumpers *		
2 Pole black	ZQV2.5N/4-2SW	1784270000
2 Pole red	ZQV2.5N/4-2RT	1784280000
2 Pole blue	ZQV2.5N/4-2BL	1784290000
Marking Tag		
	WS 10/5	1635000000
Blank - White	WS 15/5	1609880000
Holding Clamp	PRC	8536700000
Lever Blocking Device **	Plug Series Blocker	1836880000

* other colours and pole counts also available

Rider Series



RS30

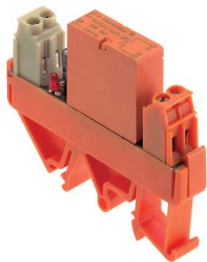

Description	Connection Type	Dimensions (LxWxH)	Accessories	Notes / Features	Approvals
MC5R 24V/48VDC	Screw Clamp	RS70 PicoPak 78x6x63mm	see Accessories for DK4/5	-	CSA, cURrs, CE
MC5R 24/48VAC/DC	Screw Clamp	PicoPak 78x6x63mm	see Accessories for DK4/5	-	CSA, cURrs, CE
PICOPAK DK6RELAY 24VDC/120VAC	Screw Clamp	PicoPak 89x8x68mm	Endplate - C9040396	-	CSA
PRS 24Vac LD 1CO PRZ 24Vac LD 1CO	Screw Clamp Tension Clamp	PlugSeries 92x15.3x95mm PlugSeries 92x15.3x87mm	see Accessories for PlugSeries	Replacement Relay - 4058510000	CSA, cURus, CE
PRS 24Vac LD 2CO PRZ 24Vac LD 2CO	Screw Clamp Tension Clamp	PlugSeries 92x15.3x95mm PlugSeries 92x15.3x87mm	see Accessories for PlugSeries	Replacement Relay - 4058600000	CSA, cURus, CE
MRS 48Vdc 1CO MRZ 48Vdc 1CO	Screw Clamp Tension Clamp	MicroSeries 93x6.1x92mm MicroSeries 94x6.1x91mm	see Accessories for MicroSeries	Replacement Relay - 4061620000	CSA, cULus, CE
MRS 60Vdc 1CO MRZ 60Vdc 1CO	Screw Clamp Tension Clamp	MicroSeries 93x6.1x92mm MicroSeries 94x6.1x91mm	see Accessories for MicroSeries	Replacement Relay - 4061630000	CSA, cURus, CE
PRS 115Vdc LD 1CO PRZ 115Vdc LD 1CO	Screw Clamp Tension Clamp	PlugSeries 92x15.3x95mm PlugSeries 92x15.3x87mm	see Accessories for PlugSeries	Replacement Relay - 4058500000	CSA, cURus, CE
PRS 115Vdc LD 2CO PRZ 115Vdc LD 2CO	Screw Clamp Tension Clamp	PlugSeries 92x15.3x95mm PlugSeries 92x15.3x87mm	see Accessories for PlugSeries	Replacement Relay - 4058590000	CSA, cURus, CE
MC5R 115VAC	Screw Clamp	PicoPak 78x6x63mm	see Accessories for DK4/5	-	cURrs, CE
RS 30 115Vac GN	Screw Clamp	RS30 74x11.2x51.5mm	-	-	CSA, CE
RSHV-AC	Screw Clamp	RS70 70x25x62mm	-	Leakage immune up to 6.5mA	CSA, CE
MC6RF 120VAC	Screw Clamp	PicoPak 89x8x71mm	Endplate - C9040396	Ouput fused @5A Fuse - Wickmann type TE5	CSA
MRS 120Vdc 1CO MRZ 120Vdc 1CO	Screw Clamp Tension Clamp	MicroSeries 93x6.1x92mm MicroSeries 94x6.1x91mm	see Accessories for MicroSeries	Replacement Relay - 4061630000	CSA, cULus, CE
MRS 120Vac 1CO RC MRZ 120Vac 1CO RC	Screw Clamp Tension Clamp	MicroSeries 93x6.1x92mm MicroSeries 94x6.1x91mm	see Accessories for MicroSeries	Leakage immune up to 3mA Replacement Relay - 4061630000	cULus, CE
MRS 120Vdc 1CO C1D2 MRZ 120Vdc 1CO C1D2	Screw Clamp Tension Clamp	MicroSeries 93x6.1x92mm MicroSeries 94x6.1x91mm	see Accessories for MicroSeries	Non-replacable Relay Replacement Relay - 4061600000	CSA, cULus, CE, CSA C1D2
MRS 120Vdc 1CO Au MRZ 120Vdc 1CO Au	Screw Clamp Tension Clamp	MicroSeries 93x6.1x92mm MicroSeries 94x6.1x91mm	see Accessories for MicroSeries	(Gold Plated Contacts) Replacement Relay - 4061600000	cULus, CE
MRS 120Vac RC C1D2 MRZ 120Vac RC C1D2	Screw Clamp Tension Clamp	MicroSeries 93x6.1x92mm MicroSeries 94x6.1x91mm	see Accessories for MicroSeries	Leakage immune up to 3mA Non-replacement Relay	CSA, cULus, CE, CSA pending C1D2
PRS 120Vac LD 1CO PRZ 120Vac LD 1CO	Screw Clamp Tension Clamp	PlugSeries 92x15.3x95mm PlugSeries 92x15.3x87mm	see Accessories for PlugSeries	Replacement Relay - 4058520000	CSA, cURus, CE
PRS 120Vac LD 2CO PRZ 120Vac LD 2CO	Screw Clamp Tension Clamp	PlugSeries 92x15.3x95mm PlugSeries 92x15.3x87mm	see Accessories for PlugSeries	Replacement Relay - 4058610000	CSA, cURus, CE
RCMKIT 120Vac 4CO LED RT RCMKITZ 120Vac 4CO LED RT	Screw Clamp Tension Clamp	RiderSeries 75x27x82mm RiderSeries 96x31x60mm	-	Replacement Relay - 1180800000	cURus, CE
MRS 230Vac 1CO Au MRZ 230Vac 1CO Au	Screw Clamp Tension Clamp	MicroSeries 93x6.1x92mm MicroSeries 94x6.1x91mm	see Accessories for MicroSeries	Replacement Relay - 4061590000 (Gold Plated Contacts)	cULus, CE
MRS230Vac 1CO MRZ 230Vac 1CO	Screw Clamp Tension Clamp	MicroSeries 93x6.1x92mm MicroSeries 94x6.1x91mm	see Accessories for MicroSeries	Replacement Relay - 4060120000	CSA, cULus, CE
PRS230Vac LD 2CO PRZ 230Vac LD 2CO	Screw Clamp Tension Clamp	PlugSeries 92x15.3x95mm PlugSeries 92x15.3x87mm	see Accessories for PlugSeries	Replacement Relay - 4058630000	CSA, cURus, CE
PRS 230Vac LD 1CO PRZ 230Vac LD 1CO	Screw Clamp Tension Clamp	PlugSeries 92x15.3x95mm PlugSeries 92x15.3x87mm	see Accessories for PlugSeries	Replacement Relay - 4058540000	CSA, cURus, CE

Electronics - Optocouplers

PicoPak DK4/5



Accessories	Description	Part Number
End plate	AP DK4	0687560000
	AP DK5	C9039986
Jumper Comb Insulated	2 Pole - QB2	0482700000
	3 Pole - QB3	0482800000
	4 Pole - QB4	0482900000
Jumper Comb Uninsulated	75 Pole straight QB75	0535200000
	75 Pole angled QB75	0526400000
Insulating cover strip	75 Pole IP75	0526700000
Marking Tag	Blank - White DEK5/6	1609820000

Input	Output Configuration	Output Specs	Part Number
24Vdc (11.5 to 28Vdc) 120Vac		5-30Vdc @ 100mA	9915700000
24Vdc (11.5 to 28Vdc)	 MOSFET Switching	5-34Vdc @ 10A	7901690001
24Vdc (11.5 to 28Vdc)	 MOSFET Switching	5-34Vdc @ 10A	7940000063
24Vdc		5-48Vdc @ 20mA	8028300000
24Vdc		5-48Vdc @ 500mA	8019590000
24Vdc		5VTTL @ 8mA	8228640000
24Vac/dc		5-48Vdc @ 20mA	8365940000
24Vdc		5VTTL @ 8mA	8324610000
24Vdc		5-48Vdc @ 100mA	8607340000 8607360000

MicroSeries



Accessories	Description	Part Number
Pluggable jumpers*	2 Pole Red ZQV 4N / 2RT	1793950000
	3 Pole Red ZQV 4N / 3RT	1793980000
	41 Pole Red ZQV 4N / 41RT	1794070000
	2 Pole Black ZQV 4N / 2SW	1793970000
	3 Pole Black ZQV 4N / 3SW	1794000000
	41 Pole Black ZQV 4N / 41SW	1794090000
Marking Tag	Blank - White WS 12/6	1609900000





*other colours and pole counts also available

24Vdc	 MOSFET Switching	3-33Vdc @ 2A	8607350000 8607370000
24Vdc		3-30Vdc @ 2.5A	8610840000 8610920000
24Vdc		3-30Vdc @ 5A	8610900000 8610970000
24Vdc	 MOSFET Switching	3-30Vac/dc @ 1A	8610890000 8610960000
24Vdc	 TRIAC Switching	3-33Vdc @ 2A	8676250000 8676230000
24Vdc	 TRIAC Switching	12-275Vac @ 2A	8610860000 8610930000
24Vdc	 TRIAC Switching	12-275Vac @ 4A	8610910000 8610980000
24Vdc	 MOSFET Switching	75-250Vac @ 1A	8652010000 8652020000
3.2-5Vdc 12-28Vdc		5-28Vdc @ 50mA	9916080000
3.5-15Vdc		5-48Vdc @ 100mA	8275390000

Electronics - Optocouplers









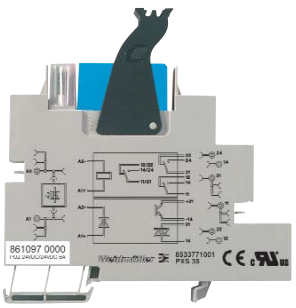

Description	Connection Type	Dimensions / Packaging Style	Accessories	Notes / Features	Approvals
PICOPAK OPTO 24/120 C/W LEAKAGE	Screw Clamp	PicoPak DK5 78x6x63mm	see Accessories for DK5	120Vac input protected up to 5mA of leakage current	CSA, cURus, CE
MC50 24VDC/5-34VDC 10A RES	Screw Clamp	MCZ 92x6x64mm	see Accessories for MCZ	Solenoid Driver - 6A rated for Inductive loads	CSA, cURus, CE, CSA C1D2, Zone 2
MCZ50 24VDC/5-34VDC 10A RES	Tension Clamp	PicoPak DK5 78x6x63mm	see Accessories for DK5	Solenoid Driver - 6A rated for Inductive loads	CSA, cURus, CE,
DKO 35 24Vdc 3KHz	Screw Clamp	PicoPak DK4 65x6x57mm	see Accessories for DK4	-	CE
DKO 35 24Vdc	Screw Clamp	PicoPak DK4 65x6x57mm	see Accessories for DK4	-	CE
DKO DK5 24Vdc 50KHz	Screw Clamp	PicoPak DK4 65x6x57mm	see Accessories for DK4	5Vdc Aux. Supply on output	CE
MCZO 24Vuc	Tension Clamp	MCZ 92x6x64mm	see Accessories for MCZ	-	cURus, CE
MCZO 24Vdc	Tension Clamp	MCZ 92x6x64mm	see Accessories for MCZ	5Vdc Aux. Supply on output	cURus, CE
MOS 24Vdc/24Vdc 0.1A MOZ 24Vdc/24Vdc 0.1A	Screw Clamp Tension Clamp	MicroSeries 93x6.1x92mm	see Accessories for MicroSeries	Replacement opto : 4061180000	cULus, CE
MOS 24Vdc/24Vdc 2A MOZ 24Vdc/24Vdc 2A	Screw Clamp Tension Clamp	MicroSeries 93x6.1x92mm	see Accessories for MicroSeries	Replacement opto : 4061190000	cULus, CE
POS 24Vdc/24Vdc 2A POZ 24Vdc/24Vdc 2A	Screw Clamp Tension Clamp	PlugOpto 92x15.3x95mm 92x15.3x87mm	see Accessories for PlugOpto	Replacement Opto : 8576350000	CSA, cURus, CE
POS 24Vdc/24Vdc 5A POZ 24Vdc/24Vdc 5A	Screw Clamp Tension Clamp	PlugOpto 92x15.3x95mm 92x15.3x87mm	see Accessories for PlugOpto	Replacement Opto : 8576350000	CSA, cURus, CE
POS 24Vdc/24Vuc 1A POZ 24Vdc/24Vuc 1A	Screw Clamp Tension Clamp	PlugOpto 92x15.3x95mm 92x15.3x87mm	see Accessories for PlugOpto	Replacement Opto : 8576380000	CSA, cURus, CE
MOS 24Vdc/24Vdc ACT MOZ 24Vdc/24Vdc ACT	Screw Clamp Tension Clamp	MicroSeries 93x6.1x92mm	see Accessories for MicroSeries	Replacement Opto : 4061190000	cULus, CE
POS 24Vdc/230Vac 2A POZ 24Vdc/230Vac 2A	Screw Clamp Tension Clamp	PlugOpto 92x15.3x95mm 92x15.3x87mm	see Accessories for PlugOpto	Replacement Opto : 8576370000	CSA, cURus, CE
POS 24Vdc/230Vac 4A POZ 24Vdc/230Vac 4A	Screw Clamp Tension Clamp	PlugOpto 92x15.3x95mm 92x15.3x87mm	see Accessories for PlugOpto	Replacement Opto : 8576360000	CSA, cURus, CE
MOS 24Vdc/230Vac 1A MOZ 24Vdc/230Vac 1A	Screw Clamp Tension Clamp	MicroSeries 93x6.1x92mm	see Accessories for MicroSeries	Replacement Opto : 4061210000	cULus, CE
MPI-Opto	Screw Clamp	WaveSeries 90x17.7x105.2mm	-	50Khz response time. Dual channel output + Inverted outputs	CSA, CE, CSA C1D2, Zone 2
WOS1 3.5-15Vdc 5KHz	Screw Clamp	WaveSeries 72x22x92.4mm	-	-	cURus, CE

Electronics - Optocouplers

MCZ			Input	Output Configuration	Output Specs	Part Number
			5VTTL @ 1mA min.		5-48Vdc @ 100mA	8228650000
			5VTTL @ 1mA min.		5-48Vdc @ 100mA	8398940000
			5Vdc @ 7.1 mA min.		5-48Vdc @ 100mA	8633020000 8633010000
Accessories						
Endplate						
Jumper Comb						
Insulated*						
Marking Tag						

Accessories	Description	Part Number
Endplate	ZAP	8389030000
Jumper Comb		
Insulated*	2 Pole - ZQV4/2	1608950000
	3 Pole - ZQV4/3	1608960000
	4 Pole - ZQV4/4	1608970000
	10 Pole - ZQV4/10	1609030000
Marking Tag		
	Blank - White DEK5/6	1609820000

*other colours and pole counts also available

Plug-Opto Series			Input	Output Configuration	Output Specs	Part Number
			5-60Vdc		5-48Vdc @ 100mA	8237730000
			16-60Vac/dc		24-230Vac @ 3.5A	8275440000
			120Vac/dc		5-48Vdc @ 100mA	8607690000 8607730000
			120Vac/dc		3-33Vdc @ 2A	8607700000 8607740000
			120Vac/dc		75-250Vac @ 1A	8651930000 8651950000
Accessories						
Jumper Comb						
Insulated*						
Marking Tag						
Holding Clamp						
Lever Blocking Device						
			115Vac/dc		19-28Vdc @ 5A	8296250000
			115Vac/dc		24-230Vac @ 3.5A	8259950000
			230Vac		5-48Vdc @ 100mA	8607710000 8607750000
			230Vac		3-33Vdc @ 2A	8607720000 8607760000
			230Vac		-230Vac @ 1A	8561990000 8651970000

Accessories	Description	Part Number
Jumper Comb Red	2 Pole - ZQV 2.5N/2 RT	1717900000
Jumper Comb Black	2 Pole - ZQV 2.5N/2 SW	1718080000
Jumper Comb Blue	2 Pole - ZQV 2.5N/2 BL	1717990000
Jumper Comb Yellow	2 Pole - ZQV 2.5N/2 GE	1693800000
Multicard for Plotter - White	WS10/5	1635000000

Description	Connection Type	Dimensions / Packaging Style	Accessories	Notes / Features	Approvals
DKO DK5 5VTTL	Screw Clamp	PicoPak DK5 78x6x63mm	see Accessories for DK5	-	cURus, CE
MCZ O 5VTTL	Tension Clamp	MCZ 92x6x64mm	see Accessories for MCZ	-	cURus, CE
MOS 5Vdc/24Vdc 0.1A MOZ 5Vdc/24Vdc 0.1A	Screw Clamp Tension Clamp	MicroSeries 93x6.1x92mm	see Accessories for MicroSeries	Replacement opto : 4064320000	cULus, CE
MOS 5Vdc/24Vdc 2A MOZ 5Vdc/24Vdc 2A	Screw Clamp Tension Clamp	MicroSeries 93x6.1x92mm	see Accessories for MicroSeries	Replacement opto : 4064310000	cULus, CE
RS-40C	Screw Clamp	RS40 70x11.2x45mm	-	Input current determined by External resistor	CSA
WOS1 15-60Vdc 1KHz	Screw Clamp	WaveSeries 72x22x92.4mm	-	-	cURus, CE
WOS2 15-60Vuc	Screw Clamp	WaveSeries 72x22x112.4mm	-	-	cURus, CE
MOS 120Vuc/24Vdc 0.1A MOZ 120Vuc/24Vdc 0.1A	Screw Clamp Tension Clamp	MicroSeries 93x6.1x92mm	see Accessories for MicroSeries	Replacement opto : 4061230000	cULus, CE
MOS 120Vuc/24Vdc 2A MOZ 120Vuc/24Vdc 2A	Screw Clamp Tension Clamp	MicroSeries 93x6.1x92mm	see Accessories for MicroSeries	Replacement opto : 4061200000	cULus, CE
MOS 120Vuc/230Vdc 1A MOZ 120Vuc/230Vdc 1A	Screw Clamp Tension Clamp	MicroSeries 93x6.1x92mm	see Accessories for MicroSeries	Replacement opto : 4061220000	cULus, CE
WOS2 115Vuc	Screw Clamp	WaveSeries 92.4x22x112.4mm	-	-	cURus, CE
WOS2 115Vuc	Screw Clamp	WaveSeries 72x22x112.4mm	-	-	cURus, CE
MOS 230Vac/24Vdc 0.1A MOZ 230Vac/24Vdc 0.1A	Screw Clamp Tension Clamp	MicroSeries 93x6.1x92mm	see Accessories for MicroSeries	Replacement opto : 4061180000	cULus, CE
MOS 230Vac/24Vdc 2A MOZ 230Vac/24Vdc 2A	Screw Clamp Tension Clamp	MicroSeries 93x6.1x92mm	see Accessories for MicroSeries	Replacement opto : 4061190000	cULus, CE
MOS 230Vac/230Vac 1A MOZ 230Vac/230Vac 1A	Screw Clamp Tension Clamp	MicroSeries 93x6.1x92mm	see Accessories for MicroSeries	Replacement opto : 4061220000	cULus, CE

Electronics - Delcon

Input Modules (SLI units)

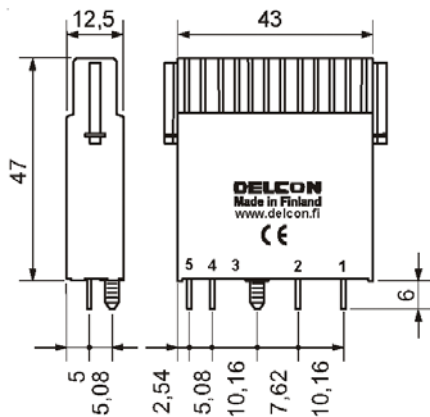







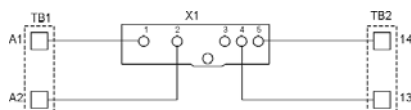
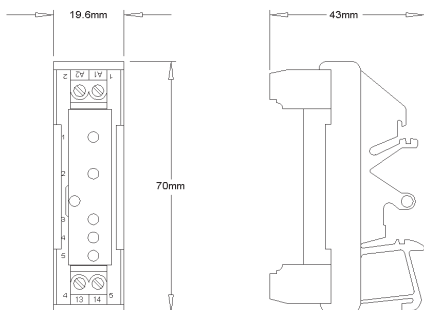





























Input Base (SLI units)



Input Base only: 9908910000



Input Voltage	Output Voltage	Output Current	Part Number
5Vdc	0-60Vdc	3A	SLO5CR
5Vdc	0-250Vdc	1.8A	SLO5CRA
5Vdc	0-32Vdc	10A	SLO5CRX
5Vdc	0-240Vac/dc	1.8A	SLO5IRA
5Vdc	0-230Vac	3A	SLO5TR
12Vdc	0-60Vdc	50mA	SLI12CR
12Vdc	0-60Vdc	50mA	SLI12CRI
12Vdc	0-60Vdc	3A	SLO12CR
12Vdc	0-250Vdc	1.8A	SLO12CRA
12Vdc	0-250Vdc	4A	SLO12CRA4
12Vdc	0-24Vdc	10A	SLO12CRX
24Vac	0-60Vdc	50mA	SLI25CR
24Vac	0-60Vdc	100mA	SLI25CRI
24Vdc	0-60Vdc	50mA	SLI24CR
24Vdc	0-60Vdc	50mA	SLI24CRF
24Vdc	0-60Vdc	50mA	SLI24CRI
24Vdc	0-60Vdc	50mA	SLI24CRL
24Vdc	0-60Vdc	3A	SLO24CL
24Vdc	0-60Vdc	3A	SLO24CR
24Vdc	0-250Vdc	1.8A	SLO24CRA
24Vdc	0-250Vdc	4A	SLO24CRA4
24Vdc	0-24Vdc	10A	SLO24CRX
24Vdc	0-240Vac/dc	1.2A	SLO24IRA
24Vdc	0-240Vac	3A	SLO24TH
24Vdc	0-240Vac	3A	SLO24TL
24Vdc	0-240Vac	3A	SLO24TR
48Vac	0-60Vdc	50mA	SLI49CR
48Vac	0-60Vdc	100mA	SLI49CRI
48Vdc	0-60Vdc	50mA	SLI48CR
48Vdc	0-60Vdc	30mA	SLI48CRI
48Vdc	0-250Vdc	1.8A	SLO48CRA
48Vdc	0-250Vdc	4A	SLO48CRA4
120Vac	0-60Vdc	50mA	SLI120CH
120Vac	0-60Vdc	50mA	SLI120CR
120Vac	0-60Vdc	100mA	SLI120CRI
120Vac	0-60Vdc	50mA	SLI120CRP
120Vac	0-240Vac	1A	SLOA120TR
120Vac	0-240Vac	3A	SLOP120TR

Application	Base Part Number	Switching Devices	Plug-in packaging colour *	Output Surge @ 20 secs.	Approvals
for Standard DC applications	9908920000	power MOSFET		15A	CE, cURus
for High DC voltage on O/P	9908920000	power MOSFET		8A	CE, cURus
for High DC currents	9908920000	power MOSFET		40A	CE, cURus
for High speed AC/DC switching	9908920000	back-to-back power MOSFET		8A	CE, cURus
for Standard AC applications	9908920000	Triac		90A	CE, cURus
for Standard DC applications	9908910000	transistor		-	CE, cURus
Normally Closed	9908910000	transistor		-	CE, cURus
for Standard DC applications	9908920000	power MOSFET		15A	CE, cURus
for High DC voltage on O/P	9908920000	power MOSFET		8A	CE, cURus
for High DC voltage on O/P	9908920000	power MOSFET		15A	CE, cURus
for High DC current on O/P	9908920000	power MOSFET		40A	CE, cURus
for Standard DC applications	9908910000	transistor		-	CE, cURus
Normally Closed	9908910000	transistor		-	CE, cURus
for Standard DC applications	9908910000	transistor		-	CE, cURus
for Fast DC Applications	9908910000	transistor		-	CE, cURus
Normally Closed	9908910000	transistor		-	CE, cURus
for High Leakage immunity	9908910000	transistor		-	CE, cURus
Low Input Current Draw	9908920000	transistor		15A	CE, cURus
for Standard DC applications	9908920000	power MOSFET		15A	CE, cURus
for High DC voltage on O/P	9908920000	power MOSFET		8A	CE, cURus
for High DC voltage on O/P	9908920000	power MOSFET		15A	CE, cURus
for High DC current on O/P	9908920000	power MOSFET		20A	CE, cURus
for High speed AC/DC switching with built in Snubber for Voltage spikes	9908920000	back-to-back power MOSFET		8A	CE, cURus
Low Input Current Draw	9908920000	Triac		90A	CE, cURus
for Standard AC applications	9908920000	Triac		90A	CE, cURus
for Standard DC applications	9908910000	transistor		-	CE, cURus
Normally Closed	9908910000	transistor		-	CE, cURus
for Standard DC applications	9908910000	transistor		-	CE, cURus
Normally Closed	9908910000	transistor		-	CE, cURus
for High DC voltage on O/P	9908920000	power MOSFET		8A	CE, cURus
for High DC voltage on O/P	9908920000	power MOSFET		15A	CE, cURus
Transient Protected	9908910000	transistor		-	CE, cURus
for Standard DC applications	9908910000	transistor		-	CE, cURus
Normally Closed	9908910000	transistor		-	CE, cURus
for proxy cables	9908910000	transistor		-	CE, cURus
for Standard AC applications	9908920000	Triac		90A	CE, cURus
Low Leakage currents on input	9908920000	Triac			

* Note:  DC Input  AC Input  AC Input/Specialty  DC Output  AC Output

Electronics - Delcon

Output Modules (SLO units)

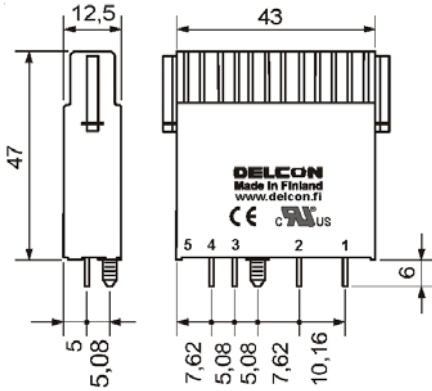

Input Voltage	Output Voltage	Output Current	Part Number
120Vdc	0-250Vdc	1.8A	SLO120CRA
120Vdc	0-250Vdc	4A	SLO120CRA4
125Vdc	0-60Vdc	50mA	SLI125CH
125Vdc	0-60Vdc	50mA	SLI125CR
125Vdc	0-60Vdc	30mA	SLI125CRI
220Vdc	0-250Vdc	1.8A	SLO220CRA
220Vdc	0-250Vdc	4A	SLO220CRA4
230Vac	0-60Vdc	50mA	SLI230CH
230Vac	0-60Vdc	50mA	SLI230CR
230Vac	0-60Vdc	100mA	SLI230CRI
230Vac	0-60Vdc	50mA	SLI230CRP
230Vac	0-60Vdc	50ma	SLI230CRR
230Vac	0-240Vac	1A	SLOA230TR
230Vac	0-240Vac	1.5A	SLOP230TR
250Vdc	0-60Vdc	50mA	SLI250CH
250Vdc	0-60Vdc	50mA	SLI250CR
250Vdc	0-60Vdc	30mA	SLI250CRI

Output base (SLO units)



Output Base only: 9908910000

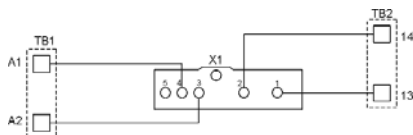
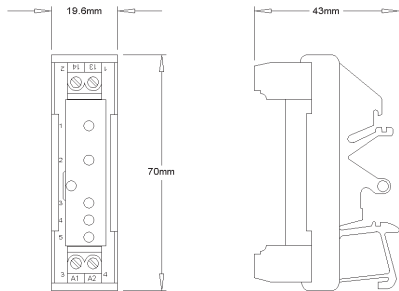

Electronics - Analog Signal Conditioners

PicoPak (DK6)

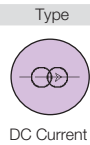
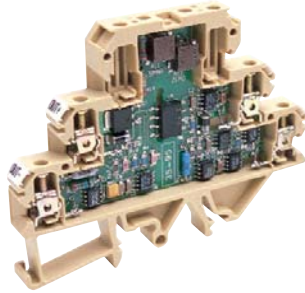

Accessories	Description	Part Number
Endplate	AP DK6	C9040396
Jumper Comb		
Insulated		
2 Pole -	QB2	0461100000
3 Pole -	QB3	0461200000
4 Pole -	QB4	0461300000
Jumper Comb Uninsulated		
58 Pole straight -	QB58	0545400000
58 Pole angled -	QB58	0545300000
Insulating cover strip		
58 Pole -	IP58	0546000000
Marking Tag		
Blank - White	DEK5/8	1856740000

Type	Input	Output	Aux. Supply	Configuration
DC Current	±1mA to ± 100mA selectabl (eg. 4-20mA)	±20mA, ±10V configurable	20-230V ac/dc	
	±1mA to ± 100mA selectable (eg. 4-20mA)	±5Vdc or ±10Vdc selectable	9-30Vdc	
	±1mA to ± 100mA selectable (eg. 4-20mA)	0-5Vdc, 0-10Vdc, 0-1mA, 0-20mA, 4-20mA selectable	9-30Vdc	
	±1mA to ± 100mA selectabl (eg. 4-20mA)	relay set point x2 SPDT	9-30Vdc	
	0-1mA	4-20mA	Output Loop Powered	
	0(4)-20mA	0(4)-20mA	Input Loop Powered	
	0(4)-20mA	0(4)-20mA	24Vdc	
	0(4)-20mA	0(4)-20mA	Input Loop Powered	
	0(4)-20mA	0(4)-20mA	Input Loop Powered	
	0(4)-20mA	0(4)-20mA	18-30Vdc	
	0(4)-20mA	0(4)-20mA	18-30Vdc	
	0(4)-20mA	0(4)-20mA	18-30Vdc	
	0(4)-20mA	0(4)-20mA	Output Loop Powered	
	0(4)-20mA	0(4)-20mA	9-30Vdc	
	0(4)-20mA	0-20A, 4-20mA, 0-10V selectable frequency	24Vdc	
	0(4)-20mA (x2)	0(4)-20mA (x2)	Input Loop Powered	
	0(4)-20mA (x2)	0(4)-20mA (x2)	Input Loop Powered	
	0-20mA	0Hz-1kHz, 4kHz, 8kHz, 16kHz selectable frequency	24Vdc	
	0-20mA	4-20mA	9-30Vdc	
	0-20mA	4-20mA	Output Loop Powered	
	0-20mA, 4-20mA selectable	0-20A, 4-20mA, 0-10V selectable	18-30Vdc	
	0-20mA, 4-20mA selectable	relay set point x2 SPDT	18-30Vdc	
	4-20mA	0-10Vdc	18-30Vdc	
	4-20mA	0-10Vdc	18-30Vdc	
	4-20mA	0-10Vdc	18-30Vdc	
	4-20mA	0-10Vdc	18-30Vdc	
	4-20mA	0-10Vdc	9-30Vdc	
	4-20mA	0-20mA	9-30Vdc	
	4-20mA	0-5Vdc	9-30Vdc	
	4-20mA	0Hz-1kHz, 4kHz, 8kHz, 16kHz selectable	24Vdc	
	4-20mA	4-20mA	Input & Output Loop Powered	
	4-20mA	4-20mA	Input & Output Loop Powered	
	4-20mA	4-20mA	18-30Vdc	
	4-20mA	4-20mA	120Vac	
	4-20mA	4-20mA	9-30Vdc	
	4-20mA	4-20mA	Input Loop Powered	
	4-20mA	4-20mA	Output Loop Powered	
	4-20mA	4-20mA (x2)	Output Loop Powered	
	4-20mA	4-20mA (x2)	Output Loop Powered	

PicoPak (DK5)



Accessories	Description	Part Number
Endplate	AP DK5	C9039986
Jumper Comb		
Insulated		
2 Pole -	QB2	0482700000
3 Pole -	QB3	0482800000
4 Pole -	QB4	0482900000
Jumper Comb Uninsulated		
75 Pole straight -	QB75	0535200000
75 Pole angled -	QB75	0526400000
Insulating cover strip		
75 Pole -	IP75	0526700000
Marking Tag		
Blank - White	DEK5/6	1609820000

Electronics - Analog Signal Conditioners

Part Number	Description	Connection Type	Packing Style / Dimensions	Accessories	Approvals
8560740000	WAS4 PRO DC/DC	Screw Clamp	WaveSeries		
8560750000	WAZ4 PRO DC/DC	Tension Clamp	90.0 x 12.5 x 113.0	ZQV 2-Pole Jumpers	cULus, CE, GL
G408-1000	UPAC Analog, X-X, BiPolar Out	Screw Clamp	Ultra SlimPak 90 x 17.7 x 112.7	Heak Sink	CSA, UL, CE
G408	UPAC Analog, X-X, UniPolar Out	Screw Clamp	Ultra SlimPak 90 x 17.7 x 112.7	Heak Sink	CSA, UL, CE
G108	UPAC ALARM DC X-X	Screw Clamp	Ultra SlimPak 90 x 17.7 x 112.7	Heak Sink	CSA, UL, CE
7940005523	DECIPAK 0-1MA		DeciPak		
Old # 992061	4-20MA/24V 2W	Screw Clamp	75.5 x 22.5 x 119.0	-	cURus, CE
8411190000	MCZ CCC	Tension Clamp	MCZ 91.0x6.0x71.0 Add 1.5mm for end plate	see Accessories MCZ	CSA, cULus, CE
8721150000	MAS RPS	Screw Clamp	MicroSeries 88.0 x 6.1 x 98.0	ZQV Jumpers	cULus, CE
8444950000	WAS5 CCC LP	Screw Clamp	WaveSeries		
8444960000	WAZ5 CCC LP	Tension Clamp	90.0 x 17.5 x 113.0	ZQV 2-Pole Jumpers	cULus, CSA, CE
8444950000C1D2	WAS5 CCC LP	Screw Clamp	WaveSeries		cULus, CSA, CE
8444960000C1D2	WAZ5 CCC LP	Tension Clamp	90.0 x 17.5 x 113.0	ZQV 2-Pole Jumpers	CSA Class 1 Div 2
8445070000	WAS4 CCC	Screw Clamp	WaveSeries		
8445080000	WAZ4 CCC	Tension Clamp	90.0 x 12.5 x 113.0	ZQV 2-Pole Jumpers	cULus, CSA, CE
8447160000	WAS5 CCC HF	Screw Clamp	WaveSeries		
8447170000	WAZ5 CCC HF	Tension Clamp	90.0 x 17.5 x 113.0	ZQV 2-Pole Jumpers	cULus, CSA, CE
8540180000	WAS5 CCC	Screw Clamp	WaveSeries		
8540190000	WAS5 CCC	Tension Clamp	90.0 x 17.5 x 113.0	ZQV 2-Pole Jumpers	cULus, CSA, CE
8543720000	WAS5 OLP	Screw Clamp	WaveSeries		
8543730000	WAZ5 OLP	Tension Clamp	90.0 x 17.5 x 113.0	ZQV 2-Pole Jumpers	cULus, CSA, CE
7940005488	DECIPAK 0-20MA		DeciPak		
Old # 992028	0-20MA/24V 4W	Screw Clamp	75.5 x 22.5 x 119.0	-	cURus, CE
8721170000	MAS RPSH	Screw Clamp	MicroSeries 88.0 x 6.1 x 98.0	ZQV Jumpers	cULus, CE
8463580000	WAS5 CCC LP 2CH.	Screw Clamp	WaveSeries		
8463590000	WAZ5 CCC LP 2CH.	Tension Clamp	90.0 x 17.5 x 113.0	ZQV 2-Pole Jumpers	cULus, CSA, CE
8463580000C1D2	WAS5 CCC LP 2CH. C1D2	Screw Clamp	WaveSeries		cULus, CSA, CE
8463590000C1D2	WAZ5 CCC LP 2CH. C1D2	Tension Clamp	90.0 x 17.5 x 113.0	ZQV 2-Pole Jumpers	CSA Class 1 Div 2
8461480000	MCZ CFC 0-20MA	Tension Clamp	MCZ 91x6.0x71.0 Add 1.5mm for end plate	see Accessories MCZ	cRUus, CE
7940005485	DECIPAK 0-20MA		DeciPak		
Old # 992025	4-20MA/24V 4W	Screw Clamp	75.5 x 22.5 x 119.0	-	cURus, CE
7940005524	DECIPAK 0-20MA		DeciPak		
Old # 992062	4-20MA/24V 2W	Screw Clamp	75.5 x 22.5 x 119.0	-	cURus, CE
8594810000	MAS DC/DC SELECT	Screw Clamp	MicroSeries		
8594840000	MAZ DC/DC SELECT	Tension Clamp	88.0 x 6.1 x 98.0	ZQV Jumpers	cULus, CE
8543820000	WAS5 WAVEANALOG DC/ALARM	Screw Clamp	WaveSerie		
8543880000	WAZ5 WAVEANALOG DC/ALARM	Tension Clamp	90.0 x 17.5 x 113.0	ZQV 2-Pole Jumpers	cULus, CSA, CE
8445040000	WAS4 CCVC DC	Screw Clamp	WaveSeries		
8445050000	WAZ4 CVC DC	Tension Clamp	90.0 x 17.5 x 113.0	ZQV 2-Pole Jumpers	cULus, CSA, CE
8447280000	WAS5 CVC HF	Screw Clamp	WaveSeries		
8447290000	WAZ5 CVC HF	Tension Clamp	90.0 x 17.5 x 113.0	ZQV 2-Pole Jumpers	cULus, CSA, CE
8540230000	WAS5 CVC DC	Screw Clamp	WaveSeries		
8540240000	WAZ5 CVC DC	Tension Clamp	90.0 x 17.5 x 113.0	ZQV 2-Pole Jumpers	cULus, CSA, CE
7940005478	DECIPAK 4-20MA		DeciPak		
Old # 992019	0-10V/24V 4W	Screw Clamp	75.5 x 22.5 x 119.0	-	cURus, CE
7940005476	DECIPAK 4-20MA		DeciPak		
Old # 992016	0-20MA/24V 4W	Screw Clamp	75.5 x 22.5 x 119.0	-	cURus, CE
7940005482	DECIPAK 4-20MA		DeciPak		
Old # 992022	0-5V/24V 4W	Screw Clamp	75.5 x 22.5 x 119.0	-	cURus, CE
8461490000	MCZ CFC 4-20MA CLP	Tension Clamp	MCZ 91x6.0x71.0 Add 1.5mm for end plate	see Accessories MCZ	cURus, CE
9908800000	PICOPAK I/I	Screw Clamp	PicoPak (DK6) 88.4x8.0x78.5 Add 1.5mm for end plate	see Accessories DK6	CSA, CE, CSA Class 1 Div 2, Zone 2
9916010000	PICOPAK MCZ I/I	Tension Clamp	MCZ 91x6.0x71.0 Add 1.5mm for end plate	see Accessories MCZ	CSA, CE
8444980000	WAS4 CCC DC	Screw Clamp	WaveSeries		
8444990000	WAZ4 CCC DC	Tension Clamp	90.0 x 17.5 x 113.0	ZQV 2-Pole Jumpers	cULus, CSA, CE
7940005471	DECIPAK 4-20MA		DeciPak		
Old # 992011	4-20MA/120V 4W	Screw Clamp	75.5 x 22.5 x 119.0	-	cURus, CE
7940005473	DECIPAK 4-20MA		DeciPak		
Old # 992013	4-20MA/24V 4W	Screw Clamp	75.5 x 22.5 x 119.0	-	cURus, CE
7940005521	DECIPAK 4-20/4-20		DeciPak		
Old # 992059	LOOP POWERED	Screw Clamp	75.5 x 22.5 x 119.0	-	cURus, CE
7940005522	DECIPAK 4-20MA		DeciPak		
Old # 992060	4-20MA/24V 2W	Screw Clamp	75.5 x 22.5 x 119.0	-	cURus, CE
7920400000	WAVEPAK LOOP SPLITTER	Screw Clamp	WaveSeries 90.0 x 12.5 x 113.0	-	CSA, CE, CSA Class 1 Div 2, Zone 2
8581160000	WAS5 CCC 20LP	Screw Clamp	WaveSeries		
8581170000	WAZ5 CCC 20LP	Tension Clamp	90.0 x 17.5 x 113.0	ZQV 2-Pole Jumpers	cULus, CSA, CE

Electronics - Analog Signal Conditioners

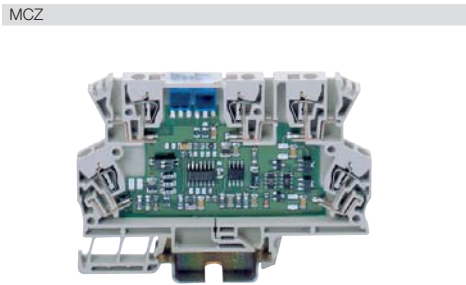

Accessories	Description	Part Number
Endplate	ZAP	8389030000
Jumper Comb Insulated	2 Pole - ZQV4/2	1608950000
	3 Pole - ZQV/3	1608960000
	4 Pole - ZQV/4	1608970000
	5 Pole - ZQV/5	1608980000
	6 Pole - ZQV/6	1608990000
	7 Pole - ZQV/7	1609000000
	8 Pole - ZQV/8	1609010000
	9 Pole - ZQV/9	1609020000
	10 Pole - ZQV/10	1609030000
Marking Tag	Blank - White DEK5/6	1609820000

Type	Input	Output	Aux. Supply	Configuration
 DC Current	500mA-2.5A	Single Relay NO/NC	24Vdc	
	500mA-6.5A	Single Relay NO/NC	24Vdc	
	2A-4A	Single Relay NO/NC	24Vdc	
	4.5A-10A	Single Relay NO/NC	24Vdc	

Type	Input	Output	Aux. Supply	Configuration
 DC Voltage	±10mVdc to ±100Vdc selectable	+5Vdc or +10Vdc selectable	9-30Vdc	
	±10mVdc to ±100Vdc selectable	0-5Vdc, 0-10Vdc, 0-1mA, 0-20mA selectable	9-30Vdc	
	±10mVdc to ±200Vdc selectable	relay set point x2 SPDT	9-30Vdc	
	±1mV to ± 200V selectable (eg. 0-10Vdc)	+20mA, +10V configurable	20-230V ac/dc	
	0-100mVdc	4-20mA	Output Loop Powered	
	0-10mVdc	4-20mA	Output Loop Powered	
	0-10Vdc	0-10Vdc	18-30Vdc	
	0-10Vdc	0-10Vdc	18-30Vdc	
	0-10Vdc	0-10Vdc	18-30Vdc	
	0-10Vdc	0-5Vdc	9-30Vdc	
	0-10Vdc	0Hz-1kHz, 4kHz, 8kHz, 16kHz selectable	24Vdc	
	0-10Vdc	0Hz-1kHz, 4kHz, 8kHz, 16kHz selectable	24Vdc	
	0-10Vdc	4-20mA	18-30Vdc	
	0-10Vdc	4-20mA	18-30Vdc	
	0-10Vdc	4-20mA	9-30Vdc	
	0-10Vdc	4-20mA	Output Loop Powered	
	0-10Vdc	relay set point x2 SPDT	18-30Vdc	
	0-10Vdc	Transistor set point (x2)	24Vdc	
0-10Vdc	Transistor set point (x2)	18-30Vdc		
0-300Vdc selectable	4-20mA	18-30Vdc		

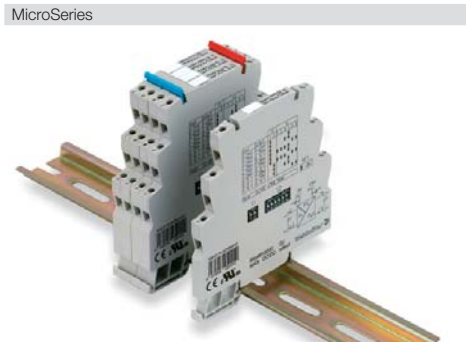

Accessories	Description	Part Number
Jumper Comb Red	2 Pole - ZQV 4N/2 RT	1793950000
	3 Pole - ZQV 4N/3 RT	1793980000
	4 Pole - ZQV 4N/4 RT	1794010000
	10 Pole - ZQV 4N/10 RT	1794040000
	41 Pole - ZQV 4N/41 RT	1794070000
Jumper Comb Blue	2 Pole - ZQV 4N/2 BL	1793960000
	3 Pole - ZQV 4N/3 BL	1793990000
	4 Pole - ZQV 4N/4 BL	1794020000
	10 Pole - ZQV 4N/10 BL	1794050000
	41 Pole - ZQV 4N/41 BL	1794080000
Marking Tag	Blank - White WS10/6	1828450000

Type	Input	Output	Aux. Supply	Configuration
 RTD	Pt100, Pt500, Pt1000, Cu10, Cu100, Ni120 or NiFe604 selectable	relay set point x2 SPDT	9-30Vdc	
	Pt100, Pt500, Pt1000, Cu10, Cu25, Cu100 selectable	0-5Vdc, 0-10Vdc, 0-1mA, 0-20mA, 4-20mA selectable	9-30Vdc	
	Pt100 -200°C to +850°C, Ni100 -60°C to +250°C configurable	0-20mA, 4-20mA, 0-10Vdc electable	18-30Vdc	
	Pt100 -200°C to +850°C, Ni100 -60°C to +250°C configurable	0-20mA, 4-20mA, 0-10Vdc selectable	18-30Vdc	
	Pt100 -40 to +100° C	4-20mA	Output Loop Powered	
	Pt100 -50 to +150° C	4-20mA	Output Loop Powered	
	Pt100 0 to +100° C	4-20mA	Output Loop Powered	
	Pt100 0 to +100° C	0-20mA, 4-20mA, 0-5Vdc, 0-10Vdc selectable	19-30Vdc	
	Pt100 0 to +120° C	4-20mA	Output Loop Powered	













Electronics - Analog Signal Conditioners

Part Number	Description	Connection Type	Packing Style / Dimensions	Accessories	Approvals
8742610000	PAS CMR 0.52.5A DC	Screw Clamp	PlugControl 92 x 15.3 x 95	-	CE, cULus
9916450000	DC CURRENT SENSOR + AMP	Screw Clamp	WaveSeries 72.0 x 22.5 x 92.4	-	CE
8742620000	PAS CMR 2.05.0 A DC	Screw Clamp	PlugControl 92 x 15.3 x 95	-	CE, cULus
8742630000	PAS CMR 4.510A DC	Screw Clamp	PlugControl 92 x 15.3 x 95	-	CE, cULus
Part Number	Description	Connection Type	Packing Style / Dimensions	Accessories	Approvals
G408-1000	UPAC Analog, X-X, BiPolar Out	Screw Clamp	Ultra SlimPak 90 x 17.7 x 112.7	Heak Sink	CSA, UL, CE
G408	UPAC Analog, X-X, UniPolar Out	Screw Clamp	Ultra SlimPak 90 x 17.7 x 112.7	Heak Sink	CSA, UL, CE
G108	UPAC ALARM DC X-X	Screw Clamp	Ultra SlimPak 90 x 17.7 x 112.7	Heak Sink	CSA, UL, CE
8560740000	WAS4 PRO DC/DC	Screw Clamp	WaveSeries		
8560750000	WAZ4 PRO DC/DC	Tension Clamp	90.0 x 12.5 x 113.0	ZQV 2-Pole Jumpers	cULus, CE, GL
7940005531	DECIPAK 0-100MV//		DeciPak		
Old # 992070	4-20MA/24V 2W	Screw Clamp	75.5 x 45.0 x 119.0	-	cURus, CE
7940005529	DECIPAK 0-10MV//		DeciPak		
Old # 992067	4-20MA/24V 2W	Screw Clamp	75.5 x 45.0 x 119.0	-	cURus, CE
8447130000	WAS4 VVC DC	Screw Clamp	WaveSeries		
8447140000	WAZ4 VVC DC	Tension Clamp	90.0 x 17.5 x 113.0	ZQV 2-Pole Jumpers	cULus, CE, GL
8447370000	WAS5 VCC HF	Screw Clamp	WaveSeries		
8447380000	WAZ5 VCC HF	Tension Clamp	90.0 x 17.5 x 113.0	ZQV 2-Pole Jumpers	cULus, CE, GL
8540330000	WAS5 VVC DC	Screw Clamp	WaveSeries		
8540340000	WAZ5 VVC DC	Tension Clamp	90.0 x 17.5 x 113.0	ZQV 2-Pole Jumpers	cULus, CE, GL
7940005508			DeciPak		
Old # 992046	DECIPAK 0-10V/0-5V/24V 4W	Screw Clamp	75.5 x 45.0 x 119.0	-	cURus, CE
8242040000	DK U-F DK5 0-10V	Screw Clamp	PicoPak (DK6) 88.4x8.0x78.5 Add 1.5mm for end plate	see Accessories DK6	cURus, CE
8461470000	MCZ VFC 0-10V	Tension Clamp	MCZ 91x6.0x71.0 Add 1.5mm for end plate	see Accessories MCZ	cURus, CE
8447100000	WAS4 VCC DC	Screw Clamp	WaveSeries		
8447110000	WAZ4 VCC DC	Tension Clamp	90.0 x 17.5 x 113.0	ZQV 2-Pole Jumpers	cULus, CE, GL
8447340000	WAS5 VCC HF	Screw Clamp	WaveSeries		
8447350000	WAZ5 VCC HF	Tension Clamp	90.0 x 17.5 x 113.0	ZQV 2-Pole Jumpers	cULus, CE, GL
8540290000	WAS5 VCC DC	Screw Clamp	WaveSeries		
8540300000	WAZ5 VCC DC	Tension Clamp	90.0 x 17.5 x 113.0	ZQV 2-Pole Jumpers	cULus, CE, GL
7940005499	DECIPAK 0-10V//		DeciPak		
Old # 992037	4-20MA/24V 4W	Screw Clamp	75.5 x 45.0 x 119.0	-	cURus, CE
7940005528	DECIPAK 0-10V//		DeciPak		
Old # 992066	4-20MA/24V 2W	Screw Clamp	75.5 x 45.0 x 119.0	-	cURus, CE
8543820000	WAS5 WAVEANALOG DC/ALARM	Screw Clamp	WaveSeries		
8543880000	WAZ5 WAVEANALOG DC/ALARM	Tension Clamp	90.0 x 17.5 x 113.0	ZQV 2-Pole Jumpers	cULus, CE, GL
8019640000	DKSC 0-10V IN/ 2 SET POINT OUT	Screw Clamp	PicoPak (DK5) 78.0x6.0x60.5 Add 1.5mm for end plate	see Accessories DK5	cURus, CE
8260280000	MCZ SC 0-10VDC SET POINT	Tension Clamp	PicoPak (MCZ) 91.0x6.0x 71.0 Add 1.5mm for end plate	see Accessories MCZ	cURus, CE
9916340000	WAVEPAK 0-300VDC/ 4-20MA/24V 3W	Screw Clamp	WaveSeries 72.5 x 22.5 x 91.5	-	CSA, CE
Part Number	Description	Connection Type	Packing Style / Dimensions	Accessories	Approvals
G118	UPAC RTD input, Setpoint Relay Out	Screw Clamp	Ultra SlimPak 90 x 17.7 x 112.7	Heak Sink	CSA, UL, CE
G418	UPAC RTD input, Analogue UniPolar Out	Screw Clamp	Ultra SlimPak 90 x 17.7 x 112.7	Heak Sink	CSA, UL, CE
8560700000	WAS5 WAVEPRO RTD	Screw Clamp	WaveSeries		
8560710000	WAZ5 WAVEPRO RTD	Tension Clamp	90.0 x 17.5 x 113.0	ZQV 2-Pole Jumpers	cULus, CE, GL
856070000C1D2	WAS5 WAVEPRO RTD C1D2	Screw Clamp	WaveSeries		cULus, CE, GL, CSA C1D2
8560710000C1D2	WAZ5 WAVEPRO RTD C1D2	Tension Clamp	90.0 x 12.5 x 113.0	ZQV 2-Pole Jumpers	Zone 2, UL Zone 2
8604430000	MCZ PT100/3 CLP -40 to +100	Tension Clamp	PicoPak (MCZ) 91.0x6.0x 71.0 Add 1.5mm for end plate	see Accessories for MCZ	cURus, CE
8473000000	MCZ PT100/3 CLP -50 to +150	Tension Clamp	PicoPak (MCZ) 91.0x6.0x 71.0 Add 1.5mm for end plate	see Accessories for MCZ	cURus, CE
8425720000	MCZ PT100/3 CLP 0-100C	Tension Clamp	PicoPak (MCZ) 91.0x6.0x 71.0 Add 1.5mm for end plate	see Accessories for MCZ	cURus, CE
8594820000	MAS PT100 0...100C Output Select	Screw Clamp	MicroSeries		
8594850000	MAZ PT100 0-100C Output Select	Tension Clamp	88.0 x 6.1 x 98.0	ZQV Jumpers	cULus, CE
8483680000	MCZ PT100/3 CLP 0-120 DEG C	Tension Clamp	PicoPak (MCZ) 91.0x6.0x 71.0 Add 1.5mm for end plate	see Accessories for MCZ	cURus, CE

Electronics - Analog Signal Conditioners









WaveSeries



Type	Input	Output	Aux. Supply	Configuration
 RTD	Pt100 0 to +150° C	4-20mA	Output Loop Powered	
	Pt100 0 to +200° C	4-20mA	Output Loop Powered	
	Pt100 0 to +300° C	4-20mA	Output Loop Powered	
	Pt100 2 wire selectable -200 to +800 deg C	0(4)-20mA	19-30Vdc	
	Pt100 2 wire selectable -200 to +800 deg C	0-10Vdc	19-30Vdc	
	Pt100 3 wire selectable -200 to +800 deg C	0(4)-20mA	19-30Vdc	
	Pt100 3 wire selectable -200 to +800 deg C	0-10Vdc	19-30Vdc	
	Pt1004 wire selectable -200 to +800 deg C	0(4)-20mA	19-30Vdc	
	Pt100 4 wire selectable -200 to +800 deg C	0-10Vdc	19-30Vdc	
	Pt1000 -200°C to +850°C, Ni1000 -60°C to +250° configurable	0-20mA, 4-20mA, 0-10Vdc selectable	18-30Vdc	
	Cu10, Cu25, Cu50, Cu100 -200° to +260°C	0-20mA, 4-20mA, 0-10Vdc selectable	18-30Vdc	

D









Accessories	Description	Part Number
Jumper Comb Red	2 Pole - ZQV 2.5N/2 RT	1717900000
Jumper Comb Black	2 Pole - ZQV 2.5N/2 SW	1718080000
Jumper Comb Blue	2 Pole - ZQV 2.5N/2 BL	1717990000
Jumper Comb Yellow	2 Pole - ZQV 2.5N/2 GE	1693800000
Marking Tag	White WS10/5	1635000000

Type	Input	Output	Aux. Supply	Configuration
 Thermocouple	Type K, J, E, N, R, S, B DIP switch selectable	0-20mA, 4-20mA, 0-10Vdc	18-30Vdc	
	Type K, J, E, N, R, S, B DIP switch selectable	0-20mA, 4-20mA, 0-10Vdc	18-30Vdc	
	Type J: -210 to 780°C Type K: -270 to 1372°C Type E: -270 to 1000°C Type T: -270 to 390°C Type R: 0 to 1760°C Type S: 0 to 1750°C Type B: 0 to 1820°C selectable	relay set point x2 SPDT	9-30Vdc	
	Type J: -210 to 780°C Type K: -270 to 1372°C Type E: -270 to 1000°C Type T: -270 to 390°C Type R: 0 to 1760°C Type S: 0 to 1750°C Type B: 0 to 1820°C selectable	0-5Vdc, 0-10Vdc, 0-1mA, 0-20mA, 4-20mA Selectable	9-30Vdc	
	Type J: -200 to 1200°C Type K: -200 to 1372°C Type E: -200 to 1000°C Type T: -200 to 400°C Type R: -50 to 1760°C Type S: -50 to 1760°C Type B: 50 to 1820°C Type N: -200 to 1300°C selectable	0-20mA, 4-20mA, 0-10Vdc	18-30Vdc	
	Type J 0 to 700°C	0-20mA, 4-20mA, 0-10Vdc	18-30Vdc	
	Type K 0 to 1000°C	0-20mA, 4-20mA, 0-10Vdc	18-30Vdc	

DeciPak



Accessories	Description	Part Number
Marking Tag	Blank - White DEK5/6.5	1609840000

Type	Input	Output	Aux. Supply	Configuration	
 Potentiometer	0-100Ω to 0-100kΩ 3 wire selectable	0-5Vdc, 0-10Vdc, 0-1mA, 0-20mA, 4-20mA selectable	9-30Vdc		
	<100kΩ 3 wire selectable 0-450Ω 2 wire selectable	0-20mA, 4-20mA, 0-10Vdc selectable	18-30Vdc		
	<100kΩ 3 wire selectable 0-450Ω 2 wire selectable	0-20mA, 4-20mA, 0-10Vdc selectable	18-30Vdc		
	>1kΩ 3 wire selectable <100kΩ 3 wire selectable 0-4500Ω 2 wire selectable	4-20mA 0-20mA, 4-20mA, 0-10Vdc selectable	Output Loop Powered 18-30Vdc		
	 Bridge/Strain	±5mV to ±200mVdc selectable	0-5Vdc, 0-10Vdc, 0-1mA, 0-20mA, 4-20mA selectable	18-30Vdc	
		0 to 200mV ±500mV selectable	0-5Vdc, 0-10Vdc, 0-20mA, 4-20mA selectable	18-30Vdc	

Electronics - Analog Signal Conditioners

Part Number	Description	Connection Type	Packing Style / Dimensions	Accessories	Approvals
8604420000	MCZ PT100/3 CLP 0-150 DEG C	Tension Clamp	PicoPak (MCZ) 91.0x6.0x 71.0 Add 1.5mm for end plate	see Accessories for MCZ	cURus, CE
8473010000	MCZ PT100/3 CLP 0-200 DEG C.	Tension Clamp	PicoPak (MCZ) 91.0x6.0x 71.0 Add 1.5mm for end plate	see Accessories for MCZ	cURus, CE
8473020000	MCZ PT100/3 CLP 0-300 DEG C	Tension Clamp	PicoPak (MCZ) 91.0x6.0x 71.0 Add 1.5mm for end plate	see Accessories for MCZ	cURus, CE
8432210000	WTS PT100/2 C	Screw Clamp	WaveSeries		
8432220000	WTZ PT100/2 C	Tension Clamp	90.0 x 17.5 x 113.0	ZQV 2-Pole Jumpers	cULus, CE,
8432180000	WTS4 PT 100/2 V	Screw Clamp	WaveSeries		
8432190000	WTZ4 PT 100/2 V	Tension Clamp	90.0 x 17.5 x 113.0	ZQV 2-Pole Jumpers	cULus, CE,
8432150000	WTS4 PT 100/3 C	Screw Clamp	WaveSeries		
8432160000	WTZ4 PT 100/3 C	Tension Clamp	90.0 x 17.5 x 113.0	ZQV 2-Pole Jumpers	cULus, CE,
8432090000	WTS4 PT 100/3 V	Screw Clamp	WaveSeries		
8432130000	WTZ4 PT 100/3 V	Tension Clamp	90.0 x 17.5 x 113.0	ZQV 2-Pole Jumpers	cULus, CE
8432270000	WTS4 PT 100/4 C	Screw Clamp	WaveSeries		
8432280000	WTZ4 PT 100/4 C	Tension Clamp	90.0 x 17.5 x 113.0	ZQV 2-Pole Jumpers	cULus, CE
8432240000	WTS4 PT 100/4 V	Screw Clamp	WaveSeries		
8432250000	WTZ4 PT 100/4 V	Tension Clamp	90.0 x 17.5 x 113.0	ZQV 2-Pole Jumpers	cULus, CE
8679490000	WAS PRO RTD PT1000	Screw Clamp	90.0 x 17.5 x 113.0 WaveSeries	ZQV 2-Pole Jumpers	cULus, CE
8638950000	WAS PRO RTD Cu	Screw Clamp	90.0 x 17.5 x 113.0 WaveSeries	ZQV 2-Pole Jumpers	cULus, CE
Part Number	Description	Connection Type	Packing Style / Dimensions	Accessories	Approvals
8560720000	WAS5 PRO Thermo	Screw Clamp	WaveSeries		
8560730000	WAZ5 PRO Thermo	Tension Clamp	90.0 x 17.5 x 113.0	ZQV 2-Pole Jumpers	cULus, CE
8560720000C1D2	WAS5 PRO Thermo C1D2	Screw Clamp	WaveSeries		
8560730000C1D2	WAZ5 PRO Thermo C1D2	Tension Clamp	90.0 x 17.5 x 113.0	ZQV 2-Pole Jumpers	cULus, CE
G128	UPAC Thermo input, Setpoint Relay Out	Screw Clamp	Ultra SlimPak 90 x 17.7 x 112.7	Heak Sink	CSA, UL, CE
G428	UPAC Thermo input, Analogue UniPolar Out	Screw Clamp	Ultra SlimPak 90 x 17.7 x 112.7	Heak Sink	CSA, UL, CE
8432300000	WTS4 Thermo Select	Screw Clamp	WaveSeries		
8432310000	WTZ4 Thermo Select	Tension Clamp	90.0 x 12.5 x 113.0	ZQV 2-Pole Jumpers	cULus, CE
8615210000	MAS Thermo-J Output Select	Screw Clamp	MicroSeries		
8615240000	MAZ Thermo-J Output Select	Tension Clamp	88.0 x 6.1 x 98.0	ZQV Jumpers	cULus, CE
8594830000	MAS Thermo-K Output Select	Screw Clamp	MicroSeries		
8594860000	MAZ Thermo-K Output Select	Tension Clamp	88.0 x 6.1 x 98.0	ZQV Jumpers	cULus, CE
Part Number	Description	Connection Type	Packing Style / Dimensions	Accessories	Approvals
G438	UPAC Potentiometer input, Analogue UniPolar Out	Screw Clamp	Ultra SlimPak 90 x 17.7 x 112.7	Heak Sink	CSA, UL, CE
8560700000	WAS5 WAVEPRO RTD	Screw Clamp	WaveSeries		
8560710000	WAZ5 WAVEPRO RTD	Tension Clamp	90.0 x 12.5 x 113.0	ZQV 2-Pole Jumpers	cULus, CE, GL
8560700000C1D2	WAS5 WAVEPRO RTD C1D2	Screw Clamp	WaveSeries		cULus, CE, GL, CSA C1D2
8560710000C1D2	WAZ5 WAVEPRO RTD C1D2	Tension Clamp	90.0 x 12.5 x 113.0	ZQV 2-Pole Jumpers	Zone 2, UL Zone 2
9908810000	PICOPAK 3 WIRE POTENTIOMETER	Screw Clamp	PicoPak (DK5) 78.0 x 6.0 x 60.5 Add 1.5mm for end plate	See Accessories DK5	CSA
8679490000	WAS5 PRO RTD 1000	Screw Clamp	90.0 x 17.5 x 113.0 WaveSeries	ZQV 2-Pole Jumpers	cULus, CE
Part Number	Description	Connection Type	Packing Style / Dimensions	Accessories	Approvals
G448	UPAC Bridge input, Analogue UniPolar Out	Screw Clamp	Ultra SlimPak 90 x 17.7 x 112.7	Heak Sink	CSA, UL, CE
8581200000	WAS5 PRO Bridge	Screw Clamp	WaveSeries		
8581210000	WAZ5 PRO Bridge	Tension Clamp	90.0 x 17.5 x 113.0	ZQV 2-Pole Jumpers	cULus, CE

Electronics - Analog Signal Conditioners

Ultra SlimPak (UPAC)



Type	Input	Output	Aux. Supply	Configuration
Frequency 	0-2Hz to 0-10kHz selectable	0-5Vdc, 0-10Vdc, 0-1mA, 0-20mA, 4-20mA selectable	18-30Vdc	
	0-1Hz to 0-1MHz	Frequency division 1 to 240 times	24Vdc	
Frequency	0-100kHz	0-20mA 4-20mA 0-10Vdc selectable	18-30Vdc	
	0 to 50Hz/100Hz/ 500Hz/1kHz/5kHz/ 10kHz/16kHz selectable	0-10Vdc	24Vdc	
Frequency	0 to 50Hz/100Hz/ 500Hz/1kHz/5kHz/ 10kHz/16kHz selectable	0(4)-20mA	24Vdc	

Accessories	Description	Part Number
Heat sink (1.6mm wide)	-	HS01-A
Shunt Resistor (for use with external current transformer)	-	C006
Marking Tag		
Blank Strips- White	DEK 5/5	0473360000
Preprinted for multi-purpose	DEK 5/5	
USP versions	(preprinted)	1609800000

Type	Input	Output	Aux. Supply	Configuration
AC Current 	0-10mA to 0-100mA selectable	set point Relay 2x SPDT	18-30Vdc	
	0-10mA to 0-100mA selectable	0-5Vdc, 0-10Vdc, 0-1mA, 0-20mA, 4-20mA Selectable	18-30Vdc	
AC Current	1/5/10A selectable	relay set point SPDT	18-30Vdc	
	1/5/10A selectable	0-20mA, 4-20mA, 0-10Vdc selectable	18-30Vdc	
AC Current	1/5/10A selectable	4-20mA	Output Loop Powered	
	0-5A	4-20mA	Output Loop Powered	
AC Current	20/40/60A selectable	relay set point SPDT	18-30Vdc	
	0.25A-25A	relay set point SPDT	18-30Vdc	

Type	Input	Output	Aux. Supply	Configuration
AC/DC Current 	5A/10A selectable	0-20mA, 4-20mA, 0-10Vdc selectable	18-30Vdc	
	20A/25A/30A selectable	0-20mA, 4-20mA, 0-10Vdc selectable	18-30Vdc	
	40A/50A/60A selectable	0-20mA, 4-20mA, 0-10Vdc selectable	18-30Vdc	







Type	Input	Output	Aux. Supply	Configuration
AC Voltage 	0-100mV to 0-200V selectable	relay set point x2 SPDT	9-30Vdc	
	0-100mV to 0-200V selectable	0-5Vdc, 0-10Vdc, 0-1mA, 0-20mA, 4-20mA Selectable	9-30Vdc	
	0-30V/70V/130V/250V/450V selectable	0-20mA, 4-20mA	1	
	1 Phase	0-10Vdc selectable	8-30Vdc	
	0-70V/140V/210V/260V selectable	relay set point SPDT	1	
	3 Phase	Set point Relay 2x SPDT	1	
	0-250V/400V selectable		8-30Vdc	

Electronics - Analog Signal Conditioners

Part Number	Description	Connection Type	Packing Style / Dimensions	Accessories	Approvals
G478	UPAC Bridge input, Analogue UniPolar Out	Screw Clamp	Ultra SlimPak 90 x 12.5 x 112.7	Heak Sink	CSA, UL, CE
9806370000	PICOPAK FREQUENCY DIVIDER DK5	Screw Clamp	PicoPak (DK5) 78.0 x 6.0 x 60.5 Add 1.5mm for end plate	see Accessories DK5	CE, cURus
8581180000	WAS5 PRO Freq	Screw Clamp	WaveSeries		
8581190000	WAZ5 PRO Freq	Tension Clamp	90.0 x 12.5 x 113.0	ZQV 2-Pole Jumpers	cULus, CE
8283810001	DK F-U DK5 0-16KHZ 24V	Screw Clamp	PicoPak (DK5) 78.0 x 6.0 x 60.5 Add 1.5mm for end plate	see Accessories DK5	CE, cURus
8311870001	DK F-I DK5 0-16 KHZ	Screw Clamp	PicoPak (DK5) 78.0 x 6.0 x 60.5 Add 1.5mm for end plate	see Accessories DK5	CE, cURus
Part Number	Description	Connection Type	Packing Style / Dimensions	Accessories	Approvals
G168	UPAC AC input, Setpoint Relay Out	Screw Clamp	Ultra SlimPak 90 x 17.7 x 112.7	Heak Sink	CSA, UL, CE
G468	UPAC AC input, Analogue UniPolar Out	Screw Clamp	Ultra SlimPak 90 x 17.7 x 112.7	Heak Sink	CSA, UL, CE
8516560000	WAS2 CMR	Screw Clamp	Waveseries		
8516570000	WAZ2 CMR	Tension Clamp	92.4 x 22.5 x 113.0	ZQV 2-Pole Jumpers	cULus, CE
8523400000	WAS1 CMA	Screw Clamp	Waveseries		
8523410000	WAZ1 CMA	Tension Clamp	72.0 x 22.5 x 92.4	ZQV 2-Pole Jumpers	cULus, CE
8528650000	WAS1 LP CMA	Screw Clamp	Waveseries		
8528660000	WAZ1 LP CMA	Tension Clamp	72.0 x 22.5 x 92.4	ZQV 2-Pole Jumpers	cULus, CE
9916240000	PICOPAK MC6/ 0-5AAC/4-20MA 2W	Screw Clamp	PicoPak 75.5 x 22.5 x 119.0	See Accessories DK6	CSA, CE
8513340000	WAS2 CMR	Screw Clamp	Waveseries		
8526600000	WAZ2 CMR	Tension Clamp	92.4 x 22.5 x 113.0	ZQV 2-Pole Jumpers	cULus, CE
9916090000	CSR	Screw Clamp	RS45 45.0 x 66.0 x 60.5	-	CSA, CE
Part Number	Description	Connection Type	Packing Style / Dimensions	Accessories	Approvals
8526610000	WAS2 CMA	Screw Clamp	Waveseries		
8526620000	WAZ2 CMA	Tension Clamp	92.4 x 22.5 x 112.4	ZQV 2-Pole Jumpers	cULus, CE
8545830000	WAS2 CMA	Screw Clamp	Waveseries		
8545840000	WAZ2 CMA	Tension Clamp	92.4 x 22.5 x 112.4	ZQV 2-Pole Jumpers	cULus, CE
8513330000	WAS2 CMA	Screw Clamp	Waveseries		
8526590000	WAZ2 CMA	Tension Clamp	92.4 x 22.5 x 112.4	ZQV 2-Pole Jumpers	cULus, CE
Part Number	Description	Connection Type	Packing Style / Dimensions	Accessories	Approvals
G168	UPAC AC input, Setpoint Relay Out	Screw Clamp	Ultra SlimPak 90 x 17.7 x 112.7	Heak Sink	CSA, UL, CE
G468	UPAC AC input, Analogue UniPolar Out	Screw Clamp	Ultra SlimPak 90 x 17.7 x 112.7	Heak Sink	CSA, UL, CE
8581220000	WAS2 VMA Vac	Screw Clamp	Waveseries		
8581230000	WAZ2 VMA Vac	Tension Clamp	92.4x22.5x112.4	ZQV 2-Pole Jumpers	cULus, CE
8705640000	WAS2 VMR 1PHASE	Screw Clamp	Waveseries 92.4 x 22.5 x 112.4	ZQV 2-Pole Jumpers	cULus, CE
8705630000	WAS2 VMR 3PHASE	Screw Clamp	Waveseries 92.4 x 22.5 x 112.4	ZQV 2-Pole Jumpers	cULus, CE





Electronics - Power Supplies



Single Phase	0.5A	1A	2.3A	6.5A	12.5
Advanced Features Power Supplies					
Input Voltage	85 - 264Vac / 120 - 300Vdc	85 - 264Vac / 120 - 300Vdc	85 - 264Vac / 120 - 300Vdc	85 - 138Vac / 195 - 250Vac Selectable	85 - 264Vac / 100 - 200Vdc
Output Voltage	24Vdc	24Vdc	24Vdc	24Vdc	24Vdc
Output Current	0.5A	1A	2.3A	6.5A	12.5A
Output Surge / Time	-	-	-	13A / 1 sec	18.5A / 300mS
Efficiency	80%	78%	80%	85%	80%
Operating Temp	-40°C - +50°C (-40°F - +122°F)	-20°C - +50°C (-4°F - +122°F)	-40°C - +50°C (-40°F - +122°F)	-20°C - +50°C (-4°F - +122°F)	-20°C - +50°C (-4°F - +122°F)
Features	Jumperable output, pluggable connectors	Plastic housing, output LED, compact size	Pluggable connectors, robust metal housing	Pluggable connectors, status relay, robust metal housing, built-in load sharing	Pluggable connectors, status relay, robust metal housing, analogue outputs, Active PFC, built-in load sharing
Dimensions (LxWxH)	90 x 18 x 112.5mm 3.54 x 0.71 x 4.43"	90.5 x 52 x 62.5mm 3.56 x 2.05 x 2.46"	98 x 57 x 131mm 3.86 x 2.24 x 5.16"	127 x 57 x 175mm 5 x 2.24 x 6.9"	104 x 240 x 155mm 4.1 x 9.45 x 6.1"
Part Number	9918840024	9928890024	9927480024	9925340024	9916250024
Type	CP SNT 12W	CP SNT 24W	CP SNT 55W	CP SNT 160W	CP SNT 300W
Approvals	CSA, UL 508 Listed, CE	CSA, UL 508 Listed, CE, UL 1310 (Class 2) for 992889 0024, CSA Class 1 Div. 2 and Zone 2 for 992889 0024 and 992889 0012	CSA, UL 508 Listed, CE, UL 1310 (Class 2) for 992748 0024, CSA Class 1 Div. 2 and Zone 2 for 992748 0024 and 992748 0012	CSA, UL 508 Listed, CE, CSA Class 1 Div. 2 and Zone 2 for 992534 0024 & 9925340012	CSA, UL 508 Listed, CE, CSA Class 1 Div 2 & Zone 2 pending
Other Voltage Variants		5Vdc @ 2A 9928890005 12Vdc @ 1.5A 9928890012 15Vdc @ 1.5A 9928890015 28Vdc @ 1A 9928890028	5Vdc @ 3A 9927480005 12-15Vdc @ 3A 9927480012 48Vdc @ 1.04A 9927480048	5Vdc @ 10A 9925340005 12-15Vdc @ 10A 9925340012 48Vdc @ 3.25A 9925340048	
Three Phase	2.3A	6.5A	12.5A	25A	40A
Advanced Features Power Supplies					
Input Voltage	342 - 528Vac Three phase	342 - 528Vac Three phase	342 - 528Vac Three phase	342 - 528Vac Three phase	342 - 528Vac Three phase
Output Voltage	24Vdc	24Vdc	24Vdc	24Vdc	24Vdc
Output Current	2.3A	6.5A	12.5A	25A	40A
Output Surge / Time	10A / 180mS	13A / 1sec	19A / 1sec	50A / 1sec	80A / 1 sec
Efficiency	85%	83%	80%	88%	90%
Operating Temp	-15°C - +50°C (5°F - +122°F)	-20°C - +50°C (-4°F - +122°F)	-0°C - +50°C (32°F - +122°F)	-10°C - +50°C (-14°F - +122°F)	-10°C - +50°C (-14°F - +122°F)
Features	Pluggable connectors, robust metal housing	Pluggable connectors, status relay, robust metal housing, built-in load sharing	Pluggable connectors, status relay, robust metal housing, built-in load sharing	Pluggable connectors, status relay, robust metal housing, analogue outputs, built-in load sharing	Pluggable connectors, status relay, robust metal housing, analogue outputs, built-in load sharing
Dimensions (LxWxH)	108 x 60 x 168mm 4.25 x 2.36 x 6.61"	138.2 x 58.4 x 177.8mm 5.44 x 2.3 x 7"	170 x 82 x 160mm 6.7 x 3.2 x 6.3"	173 x 238 x 135mm 6.8 x 9.4 x 5.3"	182 x 268 x 133mm 7.2 x 10.6 x 5.3"
Part Number	9917790324	9925340324	7924740324	7920210324	7918960324
Type	CP SNT 55W 2.3A 3 Phase	CP SNT 160W 6.5A 3 Phase	CP SNT 300W 12.5A 3 Phase	CP SNT 600W 25A 3 Phase	CP SNT 1000W 40A 3 Phase
Approvals	CSA, UL 508 Listed, CE	cULus 508 Listed, CE	cULus 508 Listed, CE	cULus 508 Listed, CE	cULus 508 Listed, CE

Single Phase	3A	5A	10A	20A	
ECO Line					
Input Voltage	85 - 264Vac / 120 - 300Vdc	85 - 138Vac / 195 - 250Vac Selectable	85 - 138Vac / 195 - 250Vac Selectable	85 - 138Vac / 195 - 250Vac Selectable	
Output Voltage	24Vdc	24Vdc	24Vdc	24Vdc	
Output Current	3A	5A	10A	20A	
Output Surege / Time	-	-	-	-	
Efficiency	80%	84%	84%	86%	
Operating Temp	-10°C - +55°C (-14°F - +131°F)	-10°C - +55°C (-14°F - +131°F)	-10°C - +55°C (-14°F - +131°F)	-10°C - +55°C (-14°F - +131°F)	
Features	Status relay, robust metal housing	Status relay, robust metal housing	Status relay, robust metal housing	Status relay, robust metal housing	
Dimensions (LxWxH)	125 x 55.5 x 110mm 4.9 x 2.2 x 4.3"	125 x 65.5 x 110mm 4.9 x 2.6 x 4.3"	125 x 125.5 x 110mm 4.9 x 4.9 x 4.3"	125 x 227.5 x 110mm 4.9 x 9 x 4.3"	
Part Number	8708660000	8708670000	8708680000	8778870000	
Type	CP SNT 70W 24V 3A	CP SNT 120W 24V 5A	CP SNT 250W 24V 10A	CP SNT 500W 24V 20A	
Approvals	cULus 508 Listed, CE, UR 60950	cULus 508 Listed, CE, UR 60950	cULus 508 Listed, CE, UR 60950	cULus 508 Listed, CE, UR 60950	
Other Voltage Variants					
Three Phase	10A	20A	40A		
ECO Line					
Input Voltage	340 - 575Vac Three phase	340 - 575Vac Three phase	340 - 575Vac Three phase		
Output Voltage	24Vdc	24Vdc	24Vdc		
Output Current	10A	20A	40A		
Output Surege / Time	-	-	-		
Efficiency	88%	88%	88%		
Operating Temp	-10°C - +55°C (-14°F - +131°F)	-10°C - +55°C (-14°F - +131°F)	-10°C - +55°C (-14°F - +131°F)		
Features	Status relay, robust metal housing	Status relay, robust metal housing	Status relay, robust metal housing		
Dimensions (LxWxH)	125 x 125.5 x 110mm 4.9 x 4.9 x 4.3"	125 x 227.5 x 110mm 4.9 x 9 x 4.3"	125 x 280 x 150mm 4.9 x 11 x 5.9"		
Part Number	8708700000	8708710000	870873 0000		
Type	CP SNT3 250W 24V 10A	CP SNT3 500W 24V 20A	CP SNT3 1000W 24V 40A		
Approvals	cULus 508 Listed, CE, UR 60950	cULus 508 Listed, CE, UR 60950	cULus 508 Listed, CE, UR 60950		

Electronics - Power Supplies

DC - DC Converters	12V - 5V	12V - 12V	12V - 15V	12V - 24V
				
Input Voltage	10.2 - 13.8 Vdc	10.2 - 13.8 Vdc	10.2 - 13.8 Vdc	10.2 - 13.8 Vdc
Output Voltage (Nominal)	5Vdc	12Vdc	15Vdc	24Vdc
Output Voltage (Adj. Range)	4.6 - 5.5Vdc	10.5 - 14.5Vdc	13 - 18Vdc	20.5 - 29.5Vdc
Output Current	8A	3A	3A	2A
Efficiency	75%	80%	80%	80%
Operating Temp	-10°C - +50°C (14°F - +122°F)	-10°C - +50°C (14°F - +122°F)	-10°C - +50°C (14°F - +122°F)	-10°C - +50°C (14°F - +122°F)
Features	Pluggable connectors, robust metal housing	Pluggable connectors, robust metal housing	Pluggable connectors, robust metal housing	Pluggable connectors, robust metal housing
Dimensions (LxWxH)	98 x 57 x 131mm 3.86 x 2.24 x 5.16"	98 x 57 x 131mm 3.86 x 2.24 x 5.16"	98 x 57 x 131mm 3.86 x 2.24 x 5.16"	98 x 57 x 131mm 3.86 x 2.24 x 5.16"
Part Number	9919371205	9919371212	9919371215	9919371224
Type	CP DCDC 12-5	CP DCDC 12-12	CP DCDC 12-15	CP DCDC 12-24
Approvals	CSA, UL 508 Listed, CE, CSA Class 1 Div. 2 and Zone 2	CSA, UL 508 Listed, CE, CSA Class 1 Div. 2 and Zone 2	CSA, UL 508 Listed, CE, CSA Class 1 Div. 2 and Zone 2	CSA, UL 508 Listed, CE, CSA Class 1 Div. 2 and Zone 2

DC - DC Converters	24V - 5V	24V - 12V	24V - 15V	24V - 24V
				
Input Voltage	20.4 - 30Vdc	20.4 - 30Vdc	20.4 - 30Vdc	20.4 - 30Vdc
Output Voltage (Nominal)	5Vdc	12Vdc	15Vdc	24Vdc
Output Voltage (Adj. Range)	4.6 - 5.5Vdc	10.5 - 14.5Vdc	13 - 18Vdc	20.5 - 29.5Vdc
Output Current	8A	3A	3A	2A
Efficiency	75%	80%	80%	80%
Operating Temp	-10°C - +50°C (14°F - +122°F)	-10°C - +50°C (14°F - +122°F)	-10°C - +50°C (14°F - +122°F)	-10°C - +50°C (14°F - +122°F)
Features	Pluggable connectors, robust metal housing	Pluggable connectors, robust metal housing	Pluggable connectors, robust metal housing	Pluggable connectors, robust metal housing
Dimensions (LxWxH)	98 x 57 x 131mm 3.86 x 2.24 x 5.16"	98 x 57 x 131mm 3.86 x 2.24 x 5.16"	98 x 57 x 131mm 3.86 x 2.24 x 5.16"	98 x 57 x 131mm 3.86 x 2.24 x 5.16"
Part Number	9919372405	9919372412	9919372415	9919372424
Type	CP DCDC 24-5	CP DCDC 24-12	CP DCDC 24-15	CP DCDC 24-24
Approvals	CSA, UL 508 Listed, CE, CSA Class 1 Div. 2 and Zone 2	CSA, UL 508 Listed, CE, CSA Class 1 Div. 2 and Zone 2	CSA, UL 508 Listed, CE, CSA Class 1 Div. 2 and Zone 2	CSA, UL 508 Listed, CE, CSA Class 1 Div. 2 and Zone 2

Battery Back-up Unit (BBU)	12Vdc	24Vdc
		
Input Voltage	85 - 264Vac / 120 - 300Vdc	85 - 264Vac / 120 - 300Vdc
Output Voltage	12Vdc	24Vdc
Output Current	15A Load	15A Load
Charge Current	3A bulk	2A bulk
Operating Temp	-20°C - +50°C (-4°F - +122°F)	-20°C - +50°C (-4°F - +122°F)
Features	Inputs for enable, drain cycle and drain reset. Relay outputs for battery status and fault. A variety of status LED's.	Inputs for enable, drain cycle and drain reset. Relay outputs for battery status and fault. A variety of status LED's.
Dimensions (LxWxH)	127.5 x 72.5 x 161mm 5.02 x 2.85 x 6.34"	125 x 65.5 x 110mm 4.9 x 2.6 x 4.3"
Part Number	9916280012	9916280024
Type	CP SNT BBU 12V	CP SNT BBU 24V
Approvals	CSA, UL 508 Listed, CE, CSA Class 1 Div. 2 and Zone 2	CSA, UL 508 Listed, CE, CSA Class 1 Div. 2 and Zone 2
Battery Size	3Ahr - Unlimited	2Ahr - Unlimited

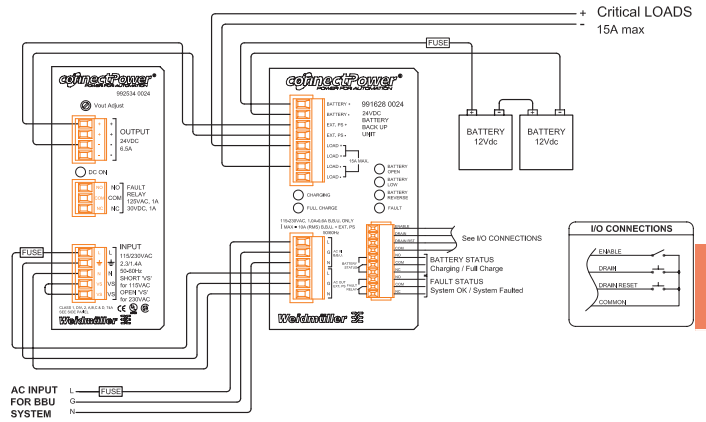





Diode Modules	DM10	DM20	RS-2D	RSD-40A	
					
Input Voltage	40Vdc maximum	40Vdc maximum	24Vdc nominal	24Vdc nominal	
Input Current	2 x 10A max.	2 x 20A max.	2 x 15A max.	2 x 20A max.	
Output Voltage	V _{in} - 0.5Vdc (typical)	V _{in} - 0.5Vdc (typical)	V _{in} - 0.38 (typical)	V _{in} - 0.4V (typical)	
Output Current	20A max.	40A max.	30A max.	40A max.	
Operating Temp	-10°C - +50°C (14°F - +122°F)	-10°C - +50°C (14°F - +122°F)	0°C - +50°C (32°F - +122°F)	0°C - +40°C (32°F - +104°F)	
Features	Robust metal housing	Robust metal housing	Voltage sensing and status relay	Fan turns on at a heatsink temperature of 60°C (140°F) and its speed will raise proportionally as the heatsink temperature increases.	
Dimensions (LxWxH)	125 x 55.5 x 110mm 4.9 x 2.2 x 4.3"	125 x 55.5 x 110mm 4.9 x 2.2 x 4.3"	70 x 110 x 90mm 2.75 x 4.33 x 3.5"	109.2 x 109.2 x 99mm 4.3 x 4.3 x 3.9"	
Part Number	8710620000	8768650000	9987390000	7940005219	
Type	CP DM 10	CP DM 20	RS-2D/SC	RSD-40A	
Approvals	cULus 508 Listed, CE	cULus 508 Listed, CE	UL recognized	cULus 508 Listed	
Variations	-	-	9987860000 - Without voltage sensing	7940005218 - One input of 40A	





Tools





Tools	Cutting and stripping tools	E.2
	Crimpers	E.3
	Screwdrivers	E.4
	Ferrules	E.8

Tools

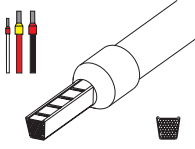
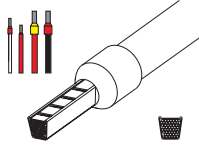
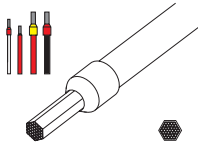
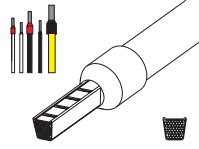
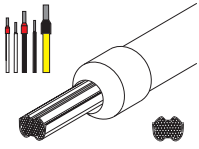
Cutters	KT 8	KT 12	KT 20	KT 36	KT 45
					
Part Number	9002650000	9002660000	9002300000	9001090000	9002000000
Solid mm ² /AWG	16/6	16/6	16/6	240/500	300/600
Stranded mm ² /AWG	16/6	25/3	35/2	240/500	300/600
Flexible mm ² /AWG	16/6	35/2	70/ 2/0	240/500	300/600

Strippers	Stripax	Stripax 16	AM12	AM25	AM35
					
Part Number	9005000000	9005610000	9030060000	9001540000	9001080000
Conductor cross-section mm ² /AWG	0.08...6/28-10AWG	6...16/10-6AWG	0.5...4/20-11AWG	-	-
Max. stripping length mm	20	20	-	-	-
Max. cutting performance mm ²	6	6	-	-	-
Length mm	190	190	97	135	140
Weight g	155	155	36	135	135
Cleaning brush	9005450000	9005450000	-	-	-
Spare stripping blade	9054030000	9054030000	-	9001530000	9001530000
Adjustable depth to cut mm	-	-	-	up to 4.5mm	up to 4.5mm

Crimpers	Stripax plus 2.5	PZ 1.5	PZ 6 HEX	PZ 4	PZ 6/5
					
					
Part Number	902000000	9005990000	9013850000	9012500000	9011460000
Crimping range mm ²	0.52...5	0.25...1.5	0.14...6	0.5...4	0.25...6
Wire range AWG	20...14	24...16	24...10	20...12	24...10
length mm	210	170	180	200	200
Weight g	260	170	380	448	423
Spare knife	9050340000				
Die Set					9011620000

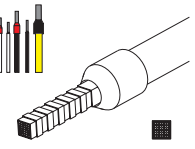
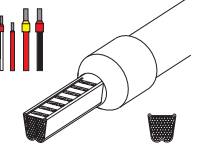
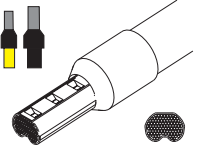
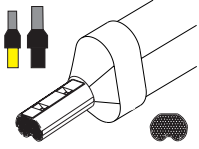
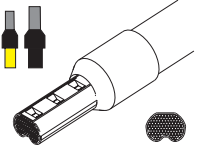
Crimpers	PZ 3	PZ 6 Roto	PZ 16	PZ ZH16	PZ 50
					
					
Part Number	0567300000	9014350000	9012600000	9013600000	9006450000
Crimping range mm ²	0.5...6	0.14...6	6...16	6...16	25...50
Wire range AWG	20...10	26...10	10...6	10...6	3...1
length mm	200	200	200	260	260
Weight g	426	428	418	700	700
Spare knife					
Die Set	9011450000	9014480000	9012640000	9054580000	9006280000

Tools

VDE Insulated Screwdriver

VDE-insulated screwdriver sets, for working on live parts up to 1000 V AC and 1500 V DC. DIN EN 60900, IEC 900. safety tested GS, checked individually. Blade made from high-alloy chromium-vanadium-molybdenum steel, through-hardened, browned

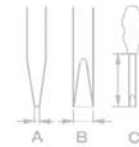

SDI S

VDE-insulated slot-head screwdriver, SDI DIN 7437, ISO 2380/2, output acc. to DIN 5264, ISO 2380/1, SoftFinish-grip



Type	Size / SW	A	B	C	Order No.
SDI 0,4x2,5x75		0.4	2.5	80	9008370000
SDI 0,5x3,0x100		0.5	3	100	9008380000
SDI 0,6x3,5x100		0.6	3.5	100	9008390000
SDI 0,8x4,0x100		0.8	4	100	9008400000
SDI 1,0x4,5x125		1	4.5	125	9008910000
SDI 1,0x5,5x125		1	5.5	125	9008410000
SDI 1,2x6,5x150		1.2	6.5	150	9008420000
SDI 1,6x8,0x175		1.6	8	200	9008430000

SDIK PH

VDE-insulated crosshead screwdriver type Phillips, SDIK PH DIN 7438, ISO 8764/2-PH, output acc. to DIN 5260-PH, ISO 8764/1-PH, SoftFinish-grip



SDIK PH0	0		60		9008560000
SDIK PH1	1		80		9008570000
SDIK PH2	2		100		9008580000
SDIK PH3	3		150		9008590000

SDIK PZ

VDE-insulated crosshead screwdriver type Pozidriv SDIK PZ DIN 7438, ISO 8764/2-PZ, output acc. to DIN 5260-PZ, ISO 8764/1-PZ, SoftFinish-grip



SDIK PZ1	1		80		9008900000
SDIK PZ2	2		100		9008890000

SDIT

VDE-insulated Torx®-screwdriver, SDIT SoftFinish-grip



SDIT 8	8		60		9201940000
SDIT 10	10		80		9009640000
SDIT 15	15		80		9009650000
SDIT 20	20		80		9009660000
SDIT 25	25		80		9009670000
SDIT 30	30		100		9009680000
SDIT 40	40		150		9009690000

SKI

VDE-insulated hexagon socket wrench, SKI SoftFinish-grip



SKI 5,0x129	5		125		9009000000
SKI 5,5x128	5,5		125		9008990000
SKI 6,0x128	6		125		9008980000
SKI 7,0x127	7		125		9008970000
SKI 8,0x127	8		125		9008960000
SKI 9,0x126	9		125		9008950000
SKI 10,0x126	10		125		9008940000
SKI 11,0x125	11		125		9008930000
SKI 13,0x125	13		125		9008920000

Uninsulated Screwdriver

Weidmüller SoftFinish screwdriver for general uses, blade made from high-alloy chromium-vanadium-molybdenum steel, through-hardened, matte chrome finish.

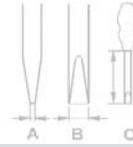

SD S

Slot-head screwdriver with circular blade SD DIN 5265, ISO 2380/2, output acc. to DIN 5264, ISO 2380/1, point chromium top, SoftFinish-grip



Type	Size / SW	A	B	C	Order No.
SD 0,4x2,0x60		0.4	2	60	9037160000
SD 0,4x2,5x75		0.4	2.5	75	9009030000
SD 0,5X3,0X80		0.5	3	80	9008320000
SD 0,6X3,5X100		0.6	3.5	100	9008330000
SD 0,6X3,5X200		0.6	3.5	200	9010110000
SD 0,8X4,0X100		0.8	4	100	9008340000
SD 1,2x6,5x150		1.2	6.5	150	9009010000
SD 0,8x4,5x125		0.8	4.5	125	9009020000
SD 1,0x5,5x150		1	5.5	125	9008350000

SDK PH

Crosshead screwdriver Type Phillips, SDK PH DIN 5262, ISO 8764/2-PH, output acc. to DIN 5260-PH, ISO 8764/1-PH, point chromium top, SoftFinish-grip



SDK PH0	0		60		9008470000
SDK PH1	1		80		9008480000
SDK PH2	2		100		9008490000
SDK PH3	3		150		9008500000

SDK PZ

Crosshead screwdriver Type Pozidriv, SDK PZ DIN 5262, ISO 8764/2-PZ, output acc. to DIN 5260-PZ, ISO 8764/1-PZ, point chromium top, SoftFinish-grip



SDK PZ0	0		60		9008520000
SDK PZ1	1		80		9008530000
SDK PZ2	2		100		9008540000
SDK PZ3	3		150		9008550000

SDTR

Torx® TR-screwdriver with drill hole in the blade point (Tamper Resistant), SD TR for screwing of Torx® and Torx®-TR safety screws (centre pin in profile), point chromium top, SoftFinish-grip



SDTR 8	8		60		9009190000
SDTR 10	10		80		9009180000
SDTR 15	15		80		9009170000
SDTR 20	20		100		9009160000
SDTR 25	25		100		9009150000
SDTR 30	30		115		9009140000

SK

Hexagon socket wrench SK DIN 3125, output acc. to DIN 3125, SoftFinish-grip



SK 5,0x125	5		125		9009130000
SK 5,5x125	5,5		125		9009120000
SK 6,0x125	6		125		9009110000
SK 7,0x125	7		125		9009100000
SK 8,0x125	8		125		9009090000
SK 9,0x125	9		125		9009080000
SK 10,0x125	10		125		9009070000
SK 11,0x125	11		125		9009060000
SK 12,0x125	12		125		9009050000
SK 13,0x125	13		125		9009040000

Tools

Torque Screwdriver (insulated)

VDE insulated torque screwdriver Weidmüller SoftFinish electric for work on live parts up to 1000 Vac and 1500 Vdc. DIN EN 60900, IEC 900, GS symbol, every one tested.



Type	Size / SW	A	B	C	Order No.
DMSI manual 0,5-1,70.5	1.7 Nm				9918390000
DMSI manual 2,0-8,02.0	8.0 Nm				9918400000

DMSI manual

VDE-insulated torque-screwdriver EN ISO 6798, BS EN 26789, ASME B107.14M



WK SI

VDE-insulated interchangeable blades for VDE-insulated torque-screwdriver output according to DIN 5264, ISO 2380/1

WK SI 0,4 x 2,5	max. 0.6 Nm	0.4	2.5	175	9918410000
WK SI 0,5 x 3,0	max. 0.6 Nm	0.5	3	175	9918420000
WK SI 0,6 x 3,5	max. 1.1 Nm	0.6	3.5	175	9918430000
WK SI 0,8 x 4,0	max. 2.5 Nm	0.8	4	175	9918440000
WK SI 1,0 x 5,5	max. 3.8 Nm	1	5.5	175	9918450000



WK IK PH

VDE-insulated interchangeable blades for VDE-insulated torque-screwdriver output according to DIN 5260-PH, ISO 8764/1-PH

WK IK PH 0	max. 0.9 Nm			175	9918460000
WK IK PH 1	max. 3.8 Nm			175	9918470000
WK IK PH 2	max. 5.5 Nm			175	9918480000



WK IK PZ

VDE-insulated interchangeable blades for VDE-insulated torque-screwdriver output according to DIN 5260-PZ, ISO 8764/1-PZ

WK IK PZ 0	max. 0.9 Nm			175	9918490000
WK IK PZ 1	max. 3.8 Nm			175	9918500000
WK IK PZ 2	max. 5.5 Nm			175	9918510000



SDIS 2,5-5,5/PH/1/2 (Screwdriver Set)

6-part set: VDE-insulated slot-head and cross-head PH Screwdriver set

SDI 0,4x2,5x75		0.4	2.5	75	
SDI 0,5x3,0x100		0.5	3	100	
SDI 0,8x4,0x100		0.8	4	100	
SDI 1,0x5,5x125		1	5.5	125	
SDI PH 1	1			80	
SDI PH 2	2			100	
SDIS 2,5-5,5/PH1/2					9009730000



Torque Screwdriver (non-insulated)

Torque-screwdriver Weidmüller SoftFinish

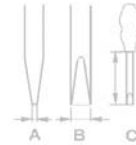

DMS manual

Torque-screwdriver

Type	Size / SW	A	B	C	Order No.
DMS manual 0,5-1,70.5 - 1.7 Nm					9918370000
DMS manual 2,0-8,02.0 - 8.0 Nm					9918380000



WK K S

Interchangeable blades for torque-screwdriver output according to DIN 5264, ISO 2380/1

WK S 0,4 x 2,5	max. 0.6 Nm	0.4	2.5	175	9918520000
WK S 0,5 x 3,0	max. 0.6 Nm	0.5	3	175	9918530000
WK S 0,6 x 3,5	max. 1.1 Nm	0.6	3.5	175	9918540000
WK S 0,8 x 4,0	max. 2.5 Nm	0.8	4	175	9918550000
WK S 1,0 x 5,5	max. 3.8 Nm	1	5.5	175	9918560000



WK K PH

Interchangeable blades for torque-screwdriver output according to DIN 5260-PH, ISO 8764/1 -PH

WK K PH 0	max. 0.9 Nm			175	9918570000
WK K PH 1	max. 3.8 Nm			175	9918580000
WK K PH 2	max. 5.5 Nm			175	9918590000



WK K PZ

Interchangeable blades for torque-screwdriver output according to DIN 5260-PZ, ISO 8764/1 -PZ

WK K PZ 0	max. 0.9 Nm			175	9918600000
WK K PZ 1	max. 3.8 Nm			175	9918610000
WK K PZ 2	max. 5.5 Nm			175	9918620000



Set S 2.5/3.0/4.0/5.5/PH 1/2 (Screwdriver Set)

12-part set of interchangeable blades for slot-head, cross-head PH screwdriver set with circular blades

SD 0,4x2,5x75		0.4	2.5	75	
SD 0,5x3,0x80		0.5	3	80	
SD 0,8x4,0x100		0.8	4	100	
SD 1,5x5,5x125		1	5.5	125	
SD PH 1	1			80	
SD PH 2	2			100	
SDS 2,5-5,5/PH1/2					9009740000



Tools

Wire end ferrules with plastic collars

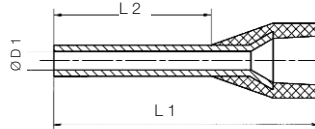

Weidmüller standard

Nominal cross-section	AWG	Dimensions (mm)				Stripping length (mm)	Qty	Type	Colour	Order No.	Strip pack Order No.	Ferrules in strip form Order No.	Ferrules on reels Order No.
		L 1	L 2	D 1	D 2								
0.14	26	10	6	0.6	1.5	8	500	H 0.14/10	● grey		9005180000		
	26	12	8	0.6	1.5	10	500	H 0.14/12	● grey		9028240000		
0.25	24	10	6	0.8	1.8	8	500	H 0.25/10	● light blue	9025740000	9026050000		
	24	12	8	0.8	1.8	10	500	H 0.25/12	● light blue	9025760000	9025780000		
0.34	22	10	6	0.8	2	8	500	H 0.34/10	● turquoise	9025750000	9026030000		
	22	12	8	0.8	2	10	500	H 0.34/12	● turquoise	9025770000	9025790000		
	22	12	8	0.8	2	10	5000	H 0.34/12	● turquoise			9004390000	
0.5	20	10	6	1	2.6	8	500	H 0.5/10	● orange		9028260000		
	20	12	6	1	2.6	8	500	H 0.5/12	● orange	0409500000			
	20	14	8	1	2.6	10	500	H 0.5/14	● orange	0690700000	9026060000	9004270000	
	20	14	8	1	2.6	10	5000	H 0.5/14	● orange				9005810000
	20	16	10	1	2.6	12	500	H 0.5/16	● orange	9025870000	9028270000		
0.75	18	12	6	1.2	2.8	8	500	H 0.75/12	○ white	0409600000	9028280000		
	18	14	8	1.2	2.8	10	500	H 0.75/14	○ white	0462900000	9026070000	9004290000	
	18	14	8	1.2	2.8	10	5000	H 0.75/14	○ white				9005820000
	18	16	10	1.2	2.8	12	500	H 0.75/16	○ white	9025860000	9028290000		
1	17	12	6	1.4	3	8	500	H 1/12	● yellow	0409700000	9028310000		
	17	14	8	1.4	3	10	500	H 1/14	● yellow	0463000000	9026080000	9004320000	
	17	14	8	1.4	3	11	5000	H 1/14	● yellow				9005830000
	17	16	10	1.4	3	12	500	H 1/16	● yellow	9025950000	9028320000		
	17	18	12	1.4	3	15	500	H 1/18	● yellow	9025930000	9028340000		
1.5	16	14	8	1.7	3.5	10	500	H 1.5/14	● red	0463100000	9026090000		
	16	14	8	1.7	3.2	10	5000	H 1.5/14	● red				9005840000
	16	14	8	1.7	3.2	10	500	H 1.5/14	● red				9004340000
	16	16	10	1.7	3.5	12	500	H 1.5/16	● red	0635100000	9028350000		
	16	18	12	1.7	3.5	15	500						
2.5	14	14	8	2.2	4.2	10	500	H 2.5/14 D	● blue	9019160000	9026100000		
	14	14	8	2.2	4	11	3000	H 2.5/14 D	● blue				9005850000
	14	14	8	2.2	4	11	500	H 2.5/14 D	● blue			9004360000	
	14	18	12	2.2	4.2	14	500	H 2.5/18 D	● blue	9019170000			
	14	24	18	2.2	4.2	20	500	H 2.5/24 D	● blue	9019180000			
4	12	17	10	2.8	4.8	12	500	H 4/17 D	● grey	9019190000	9026010000*		
	12	20	12	2.8	4.8	14	500	H 4/20 D	● grey	9019200000			
	12	26	18	2.8	4.8	20	500	H 4/26 D	● grey	9019210000			
6	10	20	12	3.5	6.3	14	100	H 6/20	● black	0533500000			
	10	26	18	3.5	6.3	20	100	H 6/26	● black	0565700000			
10	7	22	12	4.5	7.6	15	100	H 10/22	● ivory	0534200000			
	7	28	18	4.5	7.6	21	100	H 10/28	● ivory	0565800000			
Conductor													
16	6	24	12	5.8	8.8	15	100	H 16/24	● green	0565900000			
	6	28	18	5.8	8.8	21	100	H 16/28	● green	0566000000			
25	3	30	16	7.3	11.2	18	50	H 25/30	● brown	0317000000			
	3	36	22	7.3	11.2	24	50	H 25/36	● brown	0317100000			
35	2	30	16	8.3	12.7	19	50	H 35/30	● beige	0317200000			
	2	30	18	8.3	12.7	21	50						
	2	39	25	8.3	12.7	28	50	H 35/39	● beige	0317300000			
50 ...	1	36	20	10.3	15	26	50	H 50/36	● olive	0444200000			
	1	40	25	10.3	15	31	50						
	2/0	37	20	12.7	16	26	25	H 70/40	● yellow	9028200000			
	3/0	44	25	14.7	18	31	25	H 95/44	● red	9028210000			
	4/0	50	30	16.5	21	36	25	H 120/50	● blue	9028220000			
150	300 MCM	54	32	18.5	23.5	38	25	H 150/54	● yellow	9028230000			

Strip pack 5 x 100 ferrules
* 5 x 50 ferrules

Wire end ferrules without plastic collars

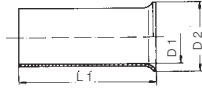

		Nominal cross-section		Dimensions (mm)			Stripping length		Type	Order No.
		(mm²)	AWG	L 1	D 1	D 2	mm	Qty		
0.25		0.25	24	5	0.7	1.65	5	1000	H 0.25/5	9018910000
0.5		0.5	20	6	1	2.1	6	1000	H 0.5/6	0282600000
		0.5	20	10	1	2.1	10	1000	H 0.5/10	9004050000
0.75		0.75	18	6	1.2	2.3	6	1000	H 0.75/6	0282700000
		0.75	18	10	1.2	2.3	10	1000	H 0.75/10	0542500000
1		1	17	6	1.4	2.5	6	1000	H 1/6	0372600000
		1	17	10	1.4	2.5	10	1000	H 1/10	0282800000
1.5		1.5	16	7	1.7	2.8	7	1000	H 1.5/7	0372700000
		1.5	16	10	1.7	2.8	10	1000	H 1.5/10	0186500000
		1.5	16	12	1.7	2.8	12	1000	H 1.5/12	9004060000
		1.5	16	18	1.7	2.8	18	1000	H 1.5/18	9004070000
2.5		2.5	14	7	2.2	3.4	7	1000	H 2.5/7	0373000000
		2.5	14	10	2.2	3.4	10	1000	H 2.5/10	9004080000
		2.5	14	12	2.2	3.4	12	1000	H 2.5/12	0186100000
		2.5	14	18	2.2	3.4	18	1000	H 2.5/18	9004090000
4		4	12	9	2.8	4	9	500	H 4/9	0373100000
		4	12	12	2.8	4	12	1000	H 4/12	0244100000
		4	12	15	2.8	4	15	500	H 4/15	9004100000
		4	12	18	2.8	4	18	1000	H 4/18	9004110000
6		6	10	10	3.5	4.7	10	500	H 6/10	9004120000
		6	10	12	3.5	4.7	12	500	H 6/12	0191900000
		6	10	15	3.5	4.7	15	500	H 6/15	0124700000
		6	10	18	3.5	4.7	18	500	H 6/18	9004130000
10		10	7	12	4.5	5.8	12	500	H 10/12	0282900000
		10	7	15	4.5	5.8	15	500	H 10/15	0124800000
		10	7	18	4.5	5.8	18	500	H 10/18	0379300000
16		16	6	12	5.8	7.5	12	500	H 16/12	0492500000
		16	6	15	5.8	7.5	15	500	H 16/15	0124300000
		16	6	18	5.8	7.5	18	100	H 16/18	0375200000
		16	6	25	5.8	7.5	25	100	H 16/25	9004150000
		16	6	32	5.8	7.5	32	100	H 16/32	9004160000
25		25	3	15	7.3	9.5	15	250	H 25/15	0124400000
		25	3	18	7.3	9.5	18	100	H 25/18	0375300000
		25	3	25	7.3	9.5	25	100	H 25/25	9004170000
		25	3	32	7.3	9.5	32	100	H 25/32	9004180000
35		35	2	18	8.3	11	18	100	H 35/18	0368900000
		35	2	25	8.3	11	25	100	H 35/25	9004190000
		35	2	30	8.3	11	30	500	H 35/30 S	9451000000
		35	2	32	8.3	11	32	100	H 35/32	9004200000
50 ...		50	1	18	10.3	13	18	100	H 50/18	9004210000
		50	1	25	10.3	13	25	100	H 50/25	9025880000
		50	1	32	10.3	13	32	100	H 50/32	9004220000
		70	2/0	25	12.5	15	25	50	H 70/25	9004230000
		70	2/0	32	12.5	15	32	50	H 70/32	9004240000
		95	3/0	25	14.5	17	25	50	H 95/25	9004250000
		95	3/0	32	14.5	17	32	50	H 95/32	9004260000
		120	4/0	32	16.5	19	32	50	H 120/32	9036240000
		150	300 MCM	32	18.5	21	32	50	H 150/32	9036250000
		185	350 MCM	32	20	23.5	32	50	H 185/32	9036260000

Tools

Crimping tools for ferrules

	PZ 1.5	stripax® plus 2.5	PZ 3	PZ 4	PZ 6 roto	PZ 6 HEX	PZ 6/5	PZ 16	PZ 50
Order No.									
	9005990000	9020000000	0567300000	9012500000	9014350000	9013650000	9011460000	9012600000	9006450000
AEH mm²									
H 0.25	●				●	●	●		
H 0.34	●				●	●	●		
H 0.5	●	●	●	●	●	●	●		
H 0.75	●	●	●	●	●	●	●		
H 1.0	●	●	●	●	●	●	●		
H 1.5	●	●	●	●	●	●	●		
H 2.5		●	●	●	●	●	●		
H 4.0			●	●	●	●	●		
H 6.0			●		●	●	●	●	
H 10.0								●	
H 16.0								●	
H 25.0								●	
H 35.0									●
H 50.0									●

● = ferrules in strip form only

Tools

E

Twin wire end ferrules are to be crimped according to the following table:

Tool	Order No.	Ferrules								
		H 0,5	H 0,75	H 1,0	H 1,5	H 2,5	H 4,0	H 6,0	H 10,0	H 16,0
PZ 1.5	9005990000	●	●							
PZ 3	0567300000	●	●	●	●	●				
PZ 4	9012500000	●	●	●	●	●				
PZ6 roto	9014350000	●	●	●	●	●	●			
PZ 6/5	9011460000		●	●	●	●	●			
PZZH16	9013600000							●	●	●

Weidmüller stocks a comprehensive range of wire end ferrules and insulated cable lugs for immediate supply.

Wire end ferrules

Wire end ferrules ensure the long-term quality of electrical connections. Another advantage is their usefulness during installation. The wide range of products embraces wire end ferrules with or without plastic collars and twin wire end ferrules in all the colours normally required by users.



Twin wire end ferrules with plastic collar

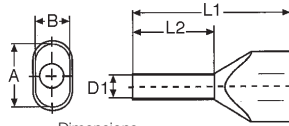

	Nominal cross-section (mm ²)	AWG	Dimensions (mm)				Stripping length (mm)	Qty
			L 1	L 2	D 1	A/B		
0.5	0.5	20	15	8	1.4	5/3	11	500
	0.5	20	16	10	1.4	5/3	13	500
	0.5	20	19	12	1.4	5/3	15	500
0.75	0.75	18	15	8	1.7	5.5/3	11	500
	0.75	18	17	10	1.7	5.5/3	13	500
	0.75	18	24	18	1.7	5.5/3	21	500
1	1.0	17	16	8	2.2	6.5/3.6	12	500
	1.0	17	15	8	2.0	5.8/3.2	12	500
	1.0	17	19	12	2.0	5.8/3.2	16	500
	1.0	17	25	18	2.0	5.8/3.2	22	500
1.5	1.5	16	16	8	2.2	6.5/3.6	11	500
	1.5	16	20	12	2.2	6.5/3.6	15	500
	1.5	16	26	18	2.2	6.5/3.6	21	100
2.5	2.5	14	19	10	2.8	8/4.5	13	500
	2.5	14	19	10	2.8	8/4.5	13	250
	2.5	14	21	12	2.8	8/4.5	15	500
	2.5	14	21	12	2.8	8/4.5	15	250
	2.5	14	27	18	2.8	8/4.5	21	500
4	4.0	12	22	12	3.5	9/5.2	15	100
	4.0	12	28	18	3.5	9/5.2	21	100
6	6.0	10	25	12	4.5	11.4/6.2	20	100
	6.0	10	29	18	4.5	11.4/6.2	24	100
10	10.0	7	24	12	5.8	13.4/7.6	17	100
	10.0	7	30	18	5.8	13.4/7.6	23	100
	10.0	7	24	12	6.5	13.4/7.6	17	100
	10.0	7	30	18	6.5	13.4/7.6	23	100
16	16.0	6	29	16	8.3	17.2/9.5	20	50

Weidmüller standard

Type	Colour	Order No.	Strip pack Order No.
H 0.5/15	orange	9037200000	9004440000*
H 0.5/16.5	orange	9037210000	
H 0.5/18.5	orange	9037220000	
H 0.75/15	white	9037230000	9018510000***
H 0.75/17	white	9037240000	9004900000*
H 0.75/24.5	white	9037250000	
H 1/15S	yellow	9018690000	9018650000*
H 1/15	yellow	9037260000	9018530000*
H 1/20	yellow	9037270000	9004910000*
H 1/25.6	yellow	9037280000	
H 1.5/16	red	9037290000	9004410000*
H 1.5/20	red	9037300000	9004920000*
H 1.5/25.6	red	9037310000	
H 2.5/18.5D	blue	9037500000	
H 2.5/18.5D	blue		9004430000**
H 2.5/20.5D	blue	9037510000	
H 2.5/20.5D	blue		9004740000**
H 2.5/26.5D	blue	9037520000	
H 4/22D	grey	9037530000	9004730000***
H 4/28D	grey	9037540000	
H 6/25	black	9037320000	9004930000***
H 6/29	black	9037330000	
H 10/26	ivory	9037340000	9004940000***
H 10/30	ivory	9037350000	
H 10/24 S	ivory	9018860000	
H 10/30 S	ivory	9018870000	
H 16/29	green	9037360000	

* 5 x 100 ** 5 x 50 *** 5 x 20

Notes

Installation Products

Installation Products

Terminal Markers	F.2
Wire and Cable Markers	F.4
Protective Sleeves	F.16
Equipment Markers	F.22
Printers	F.28
Software	F.30

Installation Products - Terminal Markers

Dekafix

Dekafix (DEK) markers are universal markers for all terminals and plug-in connectors as well as electronics modules. Including a wide range of ready-for-use prints, the system is particularly suitable for short sequences of digits.

Rapid strip mounting allows the markers to be clipped on in a single action. Available in five widths, the high-contrast print is easily legible.

- Large selection of ready-printed markers
- Rapid mounting in strips
- Terminal markers suitable for all Weidmüller terminal connectors



* NOTE: DEK 5/5 Plus MC eliminates carrier strip for easier mounting.

WS

WS markers have been optimised for W-Series terminal connectors. Thanks to their system compatibility, WS tags can be used for products from the I-Series and the Z-Series. The large marking surface is suitable for long sequences of characters as well as several lines of information.

WS markers are particularly suitable for marking lengthier, individually created sequences of characters. The proven MultiCard format means it is possible to print with the PrintJet and Plotter.

- Mount in strips or individually



* NOTE: WS 10/5 Middle and 10/6 Middle are equipped with a centred foot.

ZS

ZS markers – available in the proven MultiCard format – have been specially developed for the Z-Series. They offer a large marking surface. The hinged mechanism even allows access to cross-connectors without having to dismount the markers first. Snap-on attachment of individual tags in strips guarantees rapid mounting. The individual tags can easily be separated from the strips.

- Hinged marker surface
- Mount in strips or individually



Technical Data

Material: Polyamide - halogen-free
 Flammability class to UL94 V2 (Unless specified V0 in product description)
 Temperature range: -40 to 100°C

Possible printing systems: Plotter and PrintJet

Notes on mounting:

- Assemble in strips when the marker width = terminal width
- Assemble individually when the marker width < terminal width

Ordering data

Custom and standard pre-printed markers available.

Colour variations on request:

- brown
- yellow
- violet
- red
- green
- grey
- orange
- blue
- white

Part Number (white)	Description	Dimensions	Qty. per box
1755270000	DEK 5/3.5 MC	5mm Length, 3.5mm Width	500
1609801044	DEK 5/5 MC	5mm Length, 5mm Width	1000
1854490000	DEK 5/5 Plus MC	5mm Length, 5mm Width	1000
1609820000	DEK 5/6 MC	5mm Length, 6mm Width	1000
1789590000	DEK 5/6 MC V0	5mm Length, 6mm Width	1000
1609840000	DEK 5/6.5 MC	5mm Length, 6.5mm Width	900
1720620000	DEK 5/7.5 MC	5mm Length, 7.5mm Width	320
1856740000	DEK 5/8 MC	5mm Length, 8mm Width	800
1640740000	WS 8/5 MC	8mm Length, 5mm Width	720
1635000000	WS 10/5 MC	10mm Length, 5mm Width	720
1792000000	WS 10/5 MC Middle	10mm Length, 5mm Width	720
1828450000	WS 10/6 MC	10mm Length, 6mm Width	600
1818400000	WS 10/6 MC Middle	10mm Length, 6mm Width	600
1905950000	WS 10/8 MC	10mm Length, 8mm Width	420
1905970000	WS 10/12 MC	10mm Length, 12mm Width	300
1854090000	WS 10/15 MC	10mm Length, 15mm Width	240
1778270000	WS 12/3.5 MC	12mm Length, 3.5mm Width	600
1609860000	WS 12/5 MC	12mm Length, 5mm Width	720
1609900000	WS 12/6 MC	12mm Length, 6mm Width	600
1609920000	WS 12/6.5 MC	12mm Length, 6.5mm Width	540
1906000000	WS 12/8 MC	12mm Length, 8mm Width	420
1768090000	WS 14/5 MC	14mm Length, 5mm Width	480
1609880000	WS 15/5 MC	15mm Length, 5mm Width	480
1610000000	ZS 10/5 MC	10mm Length, 5mm Width	480
1610020000	ZS 12/6 MC	12mm Length, 6mm Width	400
1646630000	ZS 15/5 MC	15mm Length, 5mm Width	480

Installation Products - Wire & Cable

SlimFix (SFX)

SlimFix are wire and cable markers featuring a space-saving design. The markers can also be attached to the wires after these have been installed. They are made from halogen-free material and fulfill flammability class VO requirements. SlimFix is an approved and listed marker for traffic engineering. Attaching even small markers is no problem when using the SF tool.

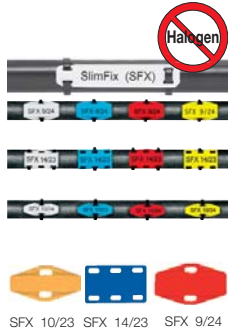

- Halogen-free material
- Flammability class VO/V2
- Approved and listed markers includes traffic engineering
- Attach to conductor cross-sections greater than 16.0 mm² with cable ties



SFX 10/23 SFX 14/23 SFX 9/24

* NOTE: SFX only - max. width of cable tie = 3.6 mm

Part Number	Description	Colour	Dimensions
1852490000	SFX 9/24	White	24mm Length, 9mm Width
1852460000	SFX 9/24	Yellow	24mm Length, 9mm Width
1852500000	SFX 9/24	Blue	24mm Length, 9mm Width
1852470000	SFX 9/24	Red	24mm Length, 9mm Width
1852390000	SFX 10/23	White	23mm Length, 10mm Width
1852360000	SFX 10/23	Yellow	23mm Length, 10mm Width
1852400000	SFX 10/23	Blue	23mm Length, 10mm Width
1852370000	SFX 10/23	Red	23mm Length, 10mm Width
1860120000	SFX 11/60	White	60mm Length, 11mm Width
1860150000	SFX 11/60	Yellow	60mm Length, 11mm Width
1860130000	SFX 11/60	Grey	60mm Length, 11mm Width
1852440000	SFX 14/23	White	23mm Length, 14mm Width
1852410000	SFX 14/23	Yellow	23mm Length, 14mm Width
1852450000	SFX 14/23	Blue	23mm Length, 14mm Width
1852420000	SFX 14/23	Red	23mm Length, 14mm Width

F

SlimFix V0 (SFX)

SlimFix are wire and cable markers featuring a space-saving design. The markers can also be attached to the wires after these have been installed. They are made from halogen-free material and fulfill flammability class VO requirements. SlimFix is an approved and listed marker for traffic engineering. Attaching even small markers is no problem when using the SF tool.

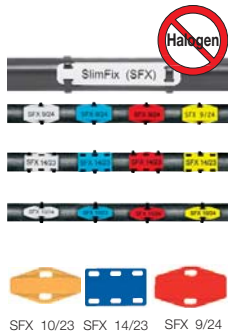

- Halogen-free material
- Flammability class VO/V2
- Approved and listed markers includes traffic engineering
- Attach to conductor cross-sections greater than 16.0 mm² with cable ties
- Markers available in the proven MultiCard format

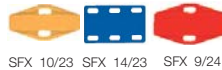

SFX 10/23 SFX 14/23 SFX 9/24

* NOTE: SFX only - max. width of cable tie = 3.6 mm

1696140001	SFX V0 9/24	White	24mm Length, 9mm Width
1696140004	SFX V0 9/24	Yellow	24mm Length, 9mm Width
1696140002	SFX V0 9/24	Blue	24mm Length, 9mm Width
1696140003	SFX V0 9/24	Red	24mm Length, 9mm Width
1727750001	SFX V0 10/23	White	23mm Length, 10mm Width
1727750004	SFX V0 10/23	Yellow	23mm Length, 10mm Width
1727750002	SFX V0 10/23	Blue	23mm Length, 10mm Width
1727750003	SFX V0 10/23	Red	23mm Length, 10mm Width
1713660001	SFX V0 14/23	White	23mm Length, 14mm Width
1713660004	SFX V0 14/23	Yellow	23mm Length, 14mm Width
1713660002	SFX V0 14/23	Blue	23mm Length, 14mm Width
1713660003	SFX V0 14/23	Red	23mm Length, 14mm Width

SlimFix (SF)

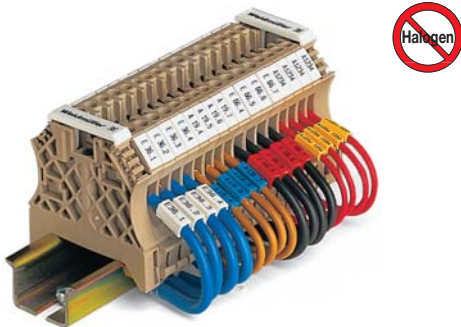

1740830001	SF 00/12	White	12mm Length
1740830004	SF 00/12	Yellow	12mm Length
1740830002	SF 00/12	Blue	12mm Length
1740830003	SF 00/12	Red	12mm Length
1724050001	SF 0/12	White	12mm Length
1724050004	SF 0/12	Yellow	12mm Length
1724050002	SF 0/12	Blue	12mm Length
1724050003	SF 0/12	Red	12mm Length
1711320001	SF 1/12	White	12mm Length

Installation Products - Wire & Cable

Qty. per box	Char. per tag using Font 10	Ext. diameter of wire (mm)	AWG	Cross-section (mm ²)	
160	11 Characters	from 7.0 mm	from AWG 8	from 16.0 mm ²	
160	11 Characters	from 7.0 mm	from AWG 8	from 16.0 mm ²	
160	11 Characters	from 7.0 mm	from AWG 8	from 16.0 mm ²	
160	11 Characters	from 7.0 mm	from AWG 8	from 16.0 mm ²	
160	11 Characters	from 7.0 mm	from AWG 8	from 16.0 mm ²	
160	11 Characters	from 7.0 mm	from AWG 8	from 16.0 mm ²	
160	11 Characters	from 7.0 mm	from AWG 8	from 16.0 mm ²	
160	11 Characters	from 7.0 mm	from AWG 8	from 16.0 mm ²	
60	22 Characters	from 7.0 mm	from AWG 8	from 16.0 mm ²	
60	22 Characters	from 7.0 mm	from AWG 8	from 16.0 mm ²	
60	22 Characters	from 7.0 mm	from AWG 8	from 16.0 mm ²	
160	11 Characters	from 7.0 mm	from AWG 8	from 16.0 mm ²	
160	11 Characters	from 7.0 mm	from AWG 8	from 16.0 mm ²	
160	11 Characters	from 7.0 mm	from AWG 8	from 16.0 mm ²	
160	11 Characters	from 7.0 mm	from AWG 8	from 16.0 mm ²	
160	11 Characters	from 7.0 mm	from AWG 8	from 16.0 mm ²	
160	11 Characters	from 7.0 mm	from AWG 8	from 16.0 mm ²	
160	11 Characters	from 7.0 mm	from AWG 8	from 16.0 mm ²	
160	11 Characters	from 7.0 mm	from AWG 8	from 16.0 mm ²	
160	11 Characters	from 7.0 mm	from AWG 8	from 16.0 mm ²	
160	11 Characters	from 7.0 mm	from AWG 8	from 16.0 mm ²	
160	11 Characters	from 7.0 mm	from AWG 8	from 16.0 mm ²	
160	11 Characters	from 7.0 mm	from AWG 8	from 16.0 mm ²	
160	11 Characters	from 7.0 mm	from AWG 8	from 16.0 mm ²	
160	11 Characters	from 7.0 mm	from AWG 8	from 16.0 mm ²	
160	11 Characters	from 7.0 mm	from AWG 8	from 16.0 mm ²	
160	11 Characters	from 7.0 mm	from AWG 8	from 16.0 mm ²	
160	11 Characters	from 7.0 mm	from AWG 8	from 16.0 mm ²	
400	5 Characters	1.0 mm - 1.3 mm	26 - 24 AWG	<0.25 mm ²	
400	5 Characters	1.0 mm - 1.3 mm	26 - 24 AWG	<0.25 mm ²	
400	5 Characters	1.0 mm - 1.3 mm	26 - 24 AWG	<0.25 mm ²	
400	5 Characters	1.0 mm - 1.3 mm	26 - 24 AWG	<0.25 mm ²	
400	5 Characters	1.3 mm - 1.6 mm	24 - 20 AWG	0.25 mm ² - 0.5 mm ²	
400	5 Characters	1.3 mm - 1.6 mm	24 - 20 AWG	0.25 mm ² - 0.5 mm ²	
400	5 Characters	1.3 mm - 1.6 mm	24 - 20 AWG	0.25 mm ² - 0.5 mm ²	
400	5 Characters	1.3 mm - 1.6 mm	24 - 20 AWG	0.25 mm ² - 0.5 mm ²	
400	5 Characters	1.6 mm - 2.1 mm	20 - 16 AWG	0.5 mm ² - 0.75 mm ²	

Installation Products

F

Installation Products - Wire & Cable

SlimFix (SF) cont'd

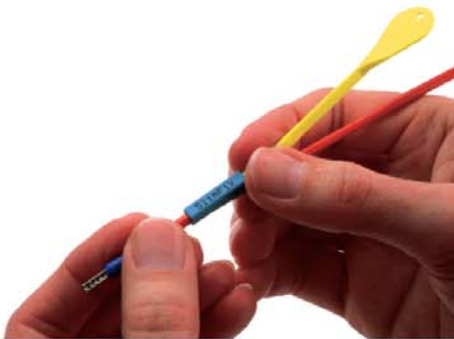
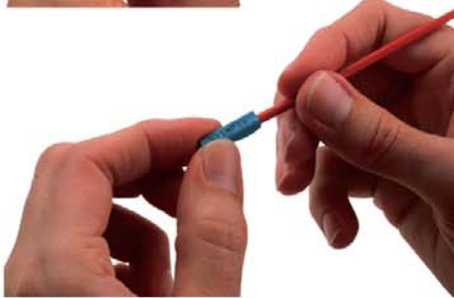

Part Number	Description	Colour	Dimensions
1711320004	SF 1/12	Yellow	12mm Length
1711320002	SF 1/12	Blue	12mm Length
1711320003	SF 1/12	Red	12mm Length
1711350001	SF 2/12	White	12mm Length
1711350004	SF 2/12	Yellow	12mm Length
1711350002	SF 2/12	Blue	12mm Length
1711350003	SF 2/12	Red	12mm Length
1711370001	SF 3/12	White	12mm Length
1711370004	SF 3/12	Yellow	12mm Length
1711370002	SF 3/12	Blue	12mm Length
1711370003	SF 3/12	Red	12mm Length
1743490001	SF 4/12	White	12mm Length
1743490004	SF 4/12	Yellow	12mm Length
1743490002	SF 4/12	Blue	12mm Length
1743490003	SF 4/12	Red	12mm Length
1743500001	SF 5/12	White	12mm Length
1743500004	SF 5/12	Yellow	12mm Length
1743500002	SF 5/12	Blue	12mm Length
1743500003	SF 5/12	Red	12mm Length
1740840001	SF 00/21	White	21mm Length
1740840004	SF 00/21	Yellow	21mm Length
1740840002	SF 00/21	Blue	21mm Length
1740840003	SF 00/21	Red	21mm Length
1740850001	SF 0/21	White	21mm Length
1740850004	SF 0/21	Yellow	21mm Length
1740850002	SF 0/21	Blue	21mm Length
1740850003	SF 0/21	Red	21mm Length
1696090001	SF 1/21	White	21mm Length
1696090004	SF 1/21	Yellow	21mm Length
1696090002	SF 1/21	Blue	21mm Length
1696090003	SF 1/21	Red	21mm Length
1696100001	SF 2/21	White	21mm Length
1696100004	SF 2/21	Yellow	21mm Length
1696100002	SF 2/21	Blue	21mm Length
1696100003	SF 2/21	Red	21mm Length
1696110001	SF 3/21	White	21mm Length
1696110004	SF 3/21	Yellow	21mm Length
1696110002	SF 3/21	Blue	21mm Length

F

Installation Products - Wire & Cable

Qty. per box	Char. per tag using Font 10	Ext. diameter of wire (mm)	AWG	Cross-section (mm ²)	
400	5 Characters	1.6 mm - 2.1 mm	20 - 16 AWG	0.5 mm ² - 0.75 mm ²	
400	5 Characters	1.6 mm - 2.1 mm	20 - 16 AWG	0.5 mm ² - 0.75 mm ²	
400	5 Characters	1.6 mm - 2.1 mm	20 - 16 AWG	0.5 mm ² - 0.75 mm ²	
400	5 Characters	2.1 mm - 2.9 mm	16 - 14 AWG	0.75 mm ² - 1.5 mm ²	
400	5 Characters	2.1 mm - 2.9 mm	16 - 14 AWG	0.75 mm ² - 1.5 mm ²	
400	5 Characters	2.1 mm - 2.9 mm	16 - 14 AWG	0.75 mm ² - 1.5 mm ²	
400	5 Characters	2.1 mm - 2.9 mm	16 - 14 AWG	0.75 mm ² - 1.5 mm ²	
320	5 Characters	2.9 mm - 3.6 mm	14 - 10 AWG	1.5 mm ² - 2.5 mm ²	
320	5 Characters	2.9 mm - 3.6 mm	14 - 10 AWG	1.5 mm ² - 2.5 mm ²	
320	5 Characters	2.9 mm - 3.6 mm	14 - 10 AWG	1.5 mm ² - 2.5 mm ²	
320	5 Characters	2.9 mm - 3.6 mm	14 - 10 AWG	1.5 mm ² - 2.5 mm ²	
128	5 Characters	3.6 mm - 4.5 mm	12 - 8 AWG	2.5 mm ² - 4 mm ²	
128	5 Characters	3.6 mm - 4.5 mm	12 - 8 AWG	2.5 mm ² - 4 mm ²	
128	5 Characters	3.6 mm - 4.5 mm	12 - 8 AWG	2.5 mm ² - 4 mm ²	
128	5 Characters	3.6 mm - 4.5 mm	12 - 8 AWG	2.5 mm ² - 4 mm ²	
160	5 Characters	4.7 mm - 5.8 mm	8 - 6 AWG	6 mm ² - 10 mm ²	
160	5 Characters	4.7 mm - 5.8 mm	8 - 6 AWG	6 mm ² - 10 mm ²	
160	5 Characters	4.7 mm - 5.8 mm	8 - 6 AWG	6 mm ² - 10 mm ²	
160	5 Characters	4.7 mm - 5.8 mm	8 - 6 AWG	6 mm ² - 10 mm ²	
400	10 Characters	1.0 mm - 1.3 mm	26 - 24 AWG	<0.25 mm ²	
400	10 Characters	1.0 mm - 1.3 mm	26 - 24 AWG	<0.25 mm ²	
400	10 Characters	1.0 mm - 1.3 mm	26 - 24 AWG	<0.25 mm ²	
400	10 Characters	1.0 mm - 1.3 mm	26 - 24 AWG	<0.25 mm ²	
400	10 Characters	1.3 mm - 1.6 mm	24 - 20 AWG	0.25 mm ² - 0.5 mm ²	
400	10 Characters	1.3 mm - 1.6 mm	24 - 20 AWG	0.25 mm ² - 0.5 mm ²	
400	10 Characters	1.3 mm - 1.6 mm	24 - 20 AWG	0.25 mm ² - 0.5 mm ²	
400	10 Characters	1.3 mm - 1.6 mm	24 - 20 AWG	0.25 mm ² - 0.5 mm ²	
400	10 Characters	1.6 mm - 2.1 mm	20 - 16 AWG	0.5 mm ² - 0.75 mm ²	
400	10 Characters	1.6 mm - 2.1 mm	20 - 16 AWG	0.5 mm ² - 0.75 mm ²	
400	10 Characters	1.6 mm - 2.1 mm	20 - 16 AWG	0.5 mm ² - 0.75 mm ²	
400	10 Characters	1.6 mm - 2.1 mm	20 - 16 AWG	0.5 mm ² - 0.75 mm ²	
400	10 Characters	2.1 mm - 2.9 mm	16 - 14 AWG	0.75 mm ² - 1.5 mm ²	
400	10 Characters	2.1 mm - 2.9 mm	16 - 14 AWG	0.75 mm ² - 1.5 mm ²	
400	10 Characters	2.1 mm - 2.9 mm	16 - 14 AWG	0.75 mm ² - 1.5 mm ²	
400	10 Characters	2.1 mm - 2.9 mm	16 - 14 AWG	0.75 mm ² - 1.5 mm ²	
320	10 Characters	2.9 mm - 3.6 mm	14 - 10 AWG	1.5 mm ² - 2.5 mm ²	
320	10 Characters	2.9 mm - 3.6 mm	14 - 10 AWG	1.5 mm ² - 2.5 mm ²	
320	10 Characters	2.9 mm - 3.6 mm	14 - 10 AWG	1.5 mm ² - 2.5 mm ²	

Installation Products - Wire & Cable

SlimFix (SF) cont'd

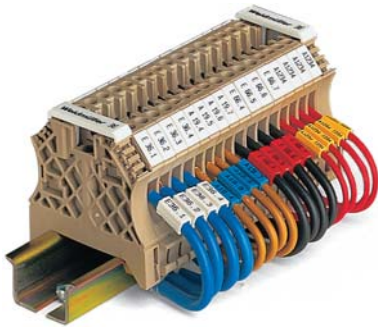

* NOTE: Attach to connected wires using SlimFix tool, see pg. F.12

Part Number	Description	Colour	Dimensions
1696110003	SF 3/21	Red	21mm Length
1696120001	SF 4/21	White	21mm Length
1696120004	SF 4/21	Yellow	21mm Length
1696120002	SF 4/21	Blue	21mm Length
1696120003	SF 4/21	Red	21mm Length
1740860001	SF 4.5/21	White	21mm Length
1740860004	SF 4.5/21	Yellow	21mm Length
1740860002	SF 4.5/21	Blue	21mm Length
1740860003	SF 4.5/21	Red	21mm Length
1696130001	SF 5/21	White	21mm Length
1696130004	SF 5/21	Yellow	21mm Length
1696130002	SF 5/21	Blue	21mm Length
1696130003	SF 5/21	Red	21mm Length
1740870001	SF 6/21	White	21mm Length
1740870004	SF 6/21	Yellow	21mm Length
1740870002	SF 6/21	Blue	21mm Length
1740870003	SF 6/21	Red	21mm Length

F

SlimFix V0 (VT-SF)

SlimFix are wire and cable markers featuring a space-saving design. The markers can also be attached to the wires after these have been installed. They are made from halogen-free material and fulfil flammability class V0 requirements. SlimFix is an approved and listed marker for traffic engineering. Attaching even small markers is no problem when using the SF tool.



- Halogen-free material
- Flammability class V0
- Approved and listed markers, includes traffic engineering
- Attach to wire cross-sections above 16.0 mm² with cable ties



1752200001	VT-SF V0 00/12	White	12mm Length
1752200004	VT-SF V0 00/12	Yellow	12mm Length
1752200002	VT-SF V0 00/12	Blue	12mm Length
1752200003	VT-SF V0 00/12	Red	12mm Length
1752110001	VT-SF V0 0/12	White	12mm Length
1752110004	VT-SF V0 0/12	Yellow	12mm Length
1752110002	VT-SF V0 0/12	Blue	12mm Length
1752110003	VT-SF V0 0/12	Red	12mm Length
1718470001	VT-SF V0 1/12	White	12mm Length
1718470004	VT-SF V0 1/12	Yellow	12mm Length
1718470002	VT-SF V0 1/12	Blue	12mm Length
1718470003	VT-SF V0 1/12	Red	12mm Length
1718480001	VT-SF V0 2/12	White	12mm Length
1718480004	VT-SF V0 2/12	Yellow	12mm Length
1718480002	VT-SF V0 2/12	Blue	12mm Length
1718480003	VT-SF V0 2/12	Red	12mm Length
1718490001	VT-SF V0 3/12	White	12mm Length
1718490004	VT-SF V0 3/12	Yellow	12mm Length
1718490002	VT-SF V0 3/12	Blue	12mm Length
1718490003	VT-SF V0 3/12	Red	12mm Length

* NOTE: Attach to connected wires using SlimFix tool, see pg. F.12

Installation Products - Wire & Cable

Qty. per box	Char. per tag using Font 10	Ext. diameter of wire (mm)	AWG	Cross-section (mm ²)
320	10 Characters	2.9 mm - 3.6 mm	14 - 10 AWG	1.5 mm ² - 2.5 mm ²
192	10 Characters	3.6 mm - 4.5 mm	12 - 8 AWG	2.5 mm ² - 4 mm ²
192	10 Characters	3.6 mm - 4.5 mm	12 - 8 AWG	2.5 mm ² - 4 mm ²
192	10 Characters	3.6 mm - 4.5 mm	12 - 8 AWG	2.5 mm ² - 4 mm ²
192	10 Characters	3.6 mm - 4.5 mm	12 - 8 AWG	2.5 mm ² - 4 mm ²
96	10 Characters	4.1 mm - 4.9 mm	10 AWG	4 mm ² - 6 mm ²
96	10 Characters	4.1 mm - 4.9 mm	10 AWG	4 mm ² - 6 mm ²
96	10 Characters	4.1 mm - 4.9 mm	10 AWG	4 mm ² - 6 mm ²
96	10 Characters	4.1 mm - 4.9 mm	10 AWG	4 mm ² - 6 mm ²
160	10 Characters	4.7 mm - 5.8 mm	8 - 6 AWG	6 mm ² - 10 mm ²
160	10 Characters	4.7 mm - 5.8 mm	8 - 6 AWG	6 mm ² - 10 mm ²
160	10 Characters	4.7 mm - 5.8 mm	8 - 6 AWG	6 mm ² - 10 mm ²
160	10 Characters	4.7 mm - 5.8 mm	8 - 6 AWG	6 mm ² - 10 mm ²
160	10 Characters	5.8 mm - 7.0 mm	6 - 4 AWG	10 mm ² - 16 mm ²
160	10 Characters	5.8 mm - 7.0 mm	6 - 4 AWG	10 mm ² - 16 mm ²
160	10 Characters	5.8 mm - 7.0 mm	6 - 4 AWG	10 mm ² - 16 mm ²
160	10 Characters	5.8 mm - 7.0 mm	6 - 4 AWG	10 mm ² - 16 mm ²
800	5 Characters	1.0 mm - 1.3 mm	26 - 24 AWG	<0.25 mm ²
800	5 Characters	1.0 mm - 1.3 mm	26 - 24 AWG	<0.25 mm ²
800	5 Characters	1.0 mm - 1.3 mm	26 - 24 AWG	<0.25 mm ²
800	5 Characters	1.0 mm - 1.3 mm	26 - 24 AWG	<0.25 mm ²
800	5 Characters	1.3 mm - 1.6 mm	24 - 20 AWG	0.25 mm ² - 0.5 mm ²
800	5 Characters	1.3 mm - 1.6 mm	24 - 20 AWG	0.25 mm ² - 0.5 mm ²
800	5 Characters	1.3 mm - 1.6 mm	24 - 20 AWG	0.25 mm ² - 0.5 mm ²
800	5 Characters	1.3 mm - 1.6 mm	24 - 20 AWG	0.25 mm ² - 0.5 mm ²
800	5 Characters	1.6 mm - 2.1 mm	20 - 16 AWG	0.5 mm ² - 0.75 mm ²
800	5 Characters	1.6 mm - 2.1 mm	20 - 16 AWG	0.5 mm ² - 0.75 mm ²
800	5 Characters	1.6 mm - 2.1 mm	20 - 16 AWG	0.5 mm ² - 0.75 mm ²
800	5 Characters	1.6 mm - 2.1 mm	20 - 16 AWG	0.5 mm ² - 0.75 mm ²
800	5 Characters	2.1 mm - 2.9 mm	16 - 14 AWG	0.75 mm ² - 1.5 mm ²
800	5 Characters	2.1 mm - 2.9 mm	16 - 14 AWG	0.75 mm ² - 1.5 mm ²
800	5 Characters	2.1 mm - 2.9 mm	16 - 14 AWG	0.75 mm ² - 1.5 mm ²
800	5 Characters	2.1 mm - 2.9 mm	16 - 14 AWG	0.75 mm ² - 1.5 mm ²
640	5 Characters	2.9 mm - 3.6 mm	14 - 10 AWG	1.5 mm ² - 2.5 mm ²
640	5 Characters	2.9 mm - 3.6 mm	14 - 10 AWG	1.5 mm ² - 2.5 mm ²
640	5 Characters	2.9 mm - 3.6 mm	14 - 10 AWG	1.5 mm ² - 2.5 mm ²
640	5 Characters	2.9 mm - 3.6 mm	14 - 10 AWG	1.5 mm ² - 2.5 mm ²

Installation Products - Wire & Cable

SlimFix V0 (VT-SF) cont'd



Part Number	Description	Colour	Dimensions
1746030001	VT-SF V0 4/12	White	12mm Length
1743490004	VT-SF V0 4/12	Yellow	12mm Length
1746030002	VT-SF V0 4/12	Blue	12mm Length
1746030003	VT-SF V0 4/12	Red	12mm Length
1746040001	VT-SF V0 5/12	White	12mm Length
1746040004	VT-SF V0 5/12	Yellow	12mm Length
1746040002	VT-SF V0 5/12	Blue	12mm Length
1746040003	VT-SF V0 5/12	Red	12mm Length
1730580001	VT-SF V0 00/21	White	21mm Length
1730580004	VT-SF V0 00/21	Yellow	21mm Length
1730580002	VT-SF V0 00/21	Blue	21mm Length
1730580003	VT-SF V0 00/21	Red	21mm Length
1730590001	VT-SF V0 0/21	White	21mm Length
1730590004	VT-SF V0 0/21	Yellow	21mm Length
1730590002	VT-SF V0 0/21	Blue	21mm Length
1730590003	VT-SF V0 0/21	Red	21mm Length
1689390001	VT-SF V0 1/21	White	21mm Length
1689390004	VT-SF V0 1/21	Yellow	21mm Length
1689390002	VT-SF V0 1/21	Blue	21mm Length
1689390003	VT-SF V0 1/21	Red	21mm Length
1689410001	VT-SF V0 2/21	White	21mm Length
1689410004	VT-SF V0 2/21	Yellow	21mm Length
1689410002	VT-SF V0 2/21	Blue	21mm Length
1689410003	VT-SF V0 2/21	Red	21mm Length
1689430001	VT-SF V0 3/21	White	21mm Length
1689430004	VT-SF V0 3/21	Yellow	21mm Length
1689430002	VT-SF V0 3/21	Blue	21mm Length
1689430003	VT-SF V0 3/21	Red	21mm Length
1689450001	VT-SF V0 4/21	White	21mm Length
1689450004	VT-SF V0 4/21	Yellow	21mm Length
1689450002	VT-SF V0 4/21	Blue	21mm Length
1689450003	VT-SF V0 4/21	Red	21mm Length
1730570001	VT-SF V0 4.5/21	White	21mm Length
1730570004	VT-SF V0 4.5/21	Yellow	21mm Length
1730570002	VT-SF V0 4.5/21	Blue	21mm Length
1730570003	VT-SF V0 4.5/21	Red	21mm Length
1689470001	VT-SF V0 5/21	White	21mm Length
1689470004	VT-SF V0 5/21	Yellow	21mm Length

Installation Products - Wire & Cable

Qty. per box	Char. per tag using Font 10	Ext. diameter of wire (mm)	AWG	Cross-section (mm ²)
192	5 Characters	3.6 mm - 4.5 mm	12 - 8 AWG	2.5 mm ² - 4 mm ²
192	5 Characters	3.6 mm - 4.5 mm	12 - 8 AWG	2.5 mm ² - 4 mm ²
192	5 Characters	3.6 mm - 4.5 mm	12 - 8 AWG	2.5 mm ² - 4 mm ²
192	5 Characters	3.6 mm - 4.5 mm	12 - 8 AWG	2.5 mm ² - 4 mm ²
160	5 Characters	4.7 mm - 5.8 mm	8 - 6 AWG	4 mm ² - 6 mm ²
160	5 Characters	4.7 mm - 5.8 mm	8 - 6 AWG	4 mm ² - 6 mm ²
160	5 Characters	4.7 mm - 5.8 mm	8 - 6 AWG	4 mm ² - 6 mm ²
160	5 Characters	4.7 mm - 5.8 mm	8 - 6 AWG	4 mm ² - 6 mm ²
800	10 Characters	1.0 mm - 1.3 mm	26 - 24 AWG	<0.25 mm ²
800	10 Characters	1.0 mm - 1.3 mm	26 - 24 AWG	<0.25 mm ²
800	10 Characters	1.0 mm - 1.3 mm	26 - 24 AWG	<0.25 mm ²
800	10 Characters	1.0 mm - 1.3 mm	26 - 24 AWG	<0.25 mm ²
800	10 Characters	1.3 mm - 1.6 mm	24 - 20 AWG	0.25 mm ² - 0.5 mm ²
800	10 Characters	1.3 mm - 1.6 mm	24 - 20 AWG	0.25 mm ² - 0.5 mm ²
800	10 Characters	1.3 mm - 1.6 mm	24 - 20 AWG	0.25 mm ² - 0.5 mm ²
800	10 Characters	1.3 mm - 1.6 mm	24 - 20 AWG	0.25 mm ² - 0.5 mm ²
800	10 Characters	1.6 mm - 2.1 mm	20 - 16 AWG	0.5 mm ² - 0.75 mm ²
800	10 Characters	1.6 mm - 2.1 mm	20 - 16 AWG	0.5 mm ² - 0.75 mm ²
800	10 Characters	1.6 mm - 2.1 mm	20 - 16 AWG	0.5 mm ² - 0.75 mm ²
800	10 Characters	1.6 mm - 2.1 mm	20 - 16 AWG	0.5 mm ² - 0.75 mm ²
800	10 Characters	2.1 mm - 2.9 mm	16 - 14 AWG	0.75 mm ² - 1.5 mm ²
800	10 Characters	2.1 mm - 2.9 mm	16 - 14 AWG	0.75 mm ² - 1.5 mm ²
800	10 Characters	2.1 mm - 2.9 mm	16 - 14 AWG	0.75 mm ² - 1.5 mm ²
800	10 Characters	2.1 mm - 2.9 mm	16 - 14 AWG	0.75 mm ² - 1.5 mm ²
512	10 Characters	2.9 mm - 3.6 mm	14 - 10 AWG	1.5 mm ² - 2.5 mm ²
512	10 Characters	2.9 mm - 3.6 mm	14 - 10 AWG	1.5 mm ² - 2.5 mm ²
512	10 Characters	2.9 mm - 3.6 mm	14 - 10 AWG	1.5 mm ² - 2.5 mm ²
512	10 Characters	2.9 mm - 3.6 mm	14 - 10 AWG	1.5 mm ² - 2.5 mm ²
288	10 Characters	3.6 mm - 4.5 mm	12 - 8 AWG	2.5 mm ² - 4 mm ²
288	10 Characters	3.6 mm - 4.5 mm	12 - 8 AWG	2.5 mm ² - 4 mm ²
288	10 Characters	3.6 mm - 4.5 mm	12 - 8 AWG	2.5 mm ² - 4 mm ²
288	10 Characters	3.6 mm - 4.5 mm	12 - 8 AWG	2.5 mm ² - 4 mm ²
192	10 Characters	4.1 mm - 4.9 mm	10 AWG	4 mm ² - 6 mm ²
192	10 Characters	4.1 mm - 4.9 mm	10 AWG	4 mm ² - 6 mm ²
192	10 Characters	4.1 mm - 4.9 mm	10 AWG	4 mm ² - 6 mm ²
192	10 Characters	4.1 mm - 4.9 mm	10 AWG	4 mm ² - 6 mm ²
160	10 Characters	4.7 mm - 5.8 mm	8 - 6 AWG	4 mm ² - 6 mm ²
160	10 Characters	4.7 mm - 5.8 mm	8 - 6 AWG	4 mm ² - 6 mm ²

Installation Products - Wire & Cable

SlimFix V0 (VT-SF) cont'd



Part Number	Description	Colour	Dimensions
1689470002	VT-SF V0 5/21	Blue	21mm Length
1689470003	VT-SF V0 5/21	Red	21mm Length
1730560001	VT-SF V0 6/21	White	21mm Length
1730560004	VT-SF V0 6/21	Yellow	21mm Length
1730560002	VT-SF V0 6/21	Red	21mm Length
1730560003	VT-SF V0 6/21	Blue	21mm Length

SlimFix Tool

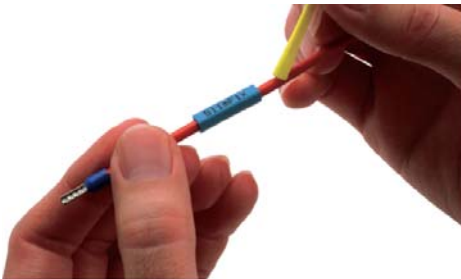

Part Number	Description	Qty. per package	Use On
1782970000	SF-Tool 1	10	SF 1/xx wire markers
1782960000	SF-Tool 2-3	10	SF 2/xx, SF 3/xx wire markers
1782980000	SF-Tool 4-5	10	SF 4/xx, SF 4.5/xx, SF 5/xx markers
1950820000	SF-Tool 00-6	10	SF 00/xx - SF 6/xx markers
1770080000	SF Tool Assortment	1	Contains 3 ea. of SF-Tool 1, 2-3, 4-5

Technical data

Material: Polyamide / Wemid - halogen-free
 Flammability class to UL94 V2 (Unless specified V0 in product description)
 Temperature range V0: -50 to 120°C / V2: -40 to 100 °C

Possible printing systems: Plotter and PrintJet

Notes on mounting:

- SF: Slide onto unconnected wires attach to connected wires using SlimFix tool
- SFX: Attach using cable ties

Ordering data

Custom and standard pre-printed markers available.

Installation Products - Wire & Cable

SlimFix Clip (SFC)

The **SlimFix Clip (SFC)** unites the optimal combination of a secure fit and high flexibility during the marking process. The unique clip mechanism offers the security of a closed marker and the rapid fitting of an open marker in one. **SlimFix Clip** is available in 3 different sizes and in 12, 21 and 30 mm lengths. The blank conductor and cable markers in MultiCard format can be printed using various marking systems. Very long number combinations are possible, depending on the tag length.

- Halogen-free material with flammability rating V2
- Slim marker with compensating device for secure fitting
- Clip mechanism enables secure fitting even after the conductor is connected
- Rapid fitting without the use of additional tools
- Three sizes for conductor cross sections of 0.5 – 4.0 mm²
- Available in 12, 21 and 30 mm lengths.
- Additional marking space for exact project allocation
- Available as customized markers according to individual requirements

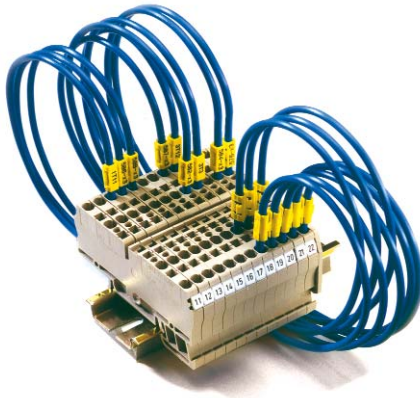
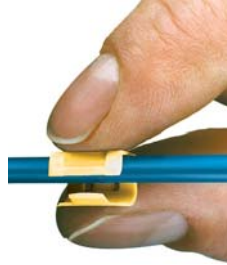

Technical data

Material: Polyamide - halogen-free
 Flammability class to UL94 V2 (Unless specified V0 in product description)
 Temperature range: -40 to 100°C

Possible printing systems: Plotter and PrintJet

Notes on mounting:

- Attach to unconnected wires and connected wires

Ordering data

Custom and standard pre-printed markers available.

Part Number	Description	Colour	Dimensions
1813130000	SFC 0/12	White	12mm Length
1813160000	SFC 0/12	Yellow	12mm Length
1813170000	SFC 0/12	Blue	12mm Length
1813150000	SFC 0/12	Red	12mm Length
1747320001	SFC 1/12	White	12mm Length
1747320004	SFC 1/12	Yellow	12mm Length
1747320002	SFC 1/12	Blue	12mm Length
1747320003	SFC 1/12	Red	12mm Length
1758320001	SFC 2/12	White	12mm Length
1758320004	SFC 2/12	Yellow	12mm Length
1758320002	SFC 2/12	Blue	12mm Length
1758320003	SFC 2/12	Red	12mm Length
1813190000	SFC 0/21	White	21mm Length
1813210000	SFC 0/21	Yellow	21mm Length
1813220000	SFC 0/21	Blue	21mm Length
1813200000	SFC 0/21	Red	21mm Length
1779080001	SFC 1/21	White	21mm Length
1779080004	SFC 1/21	Yellow	21mm Length
1779080002	SFC 1/21	Blue	21mm Length
1779080003	SFC 1/21	Red	21mm Length
1805810000	SFC 2/21	White	21mm Length
1805780000	SFC 2/21	Yellow	21mm Length
1805770000	SFC 2/21	Blue	21mm Length
1805790000	SFC 2/21	Red	21mm Length
1813240000	SFC 0/30	White	30mm Length
1813260000	SFC 0/30	Yellow	30mm Length
1813270000	SFC 0/30	Blue	30mm Length
1813250000	SFC 0/30	Red	30mm Length
1805760000	SFC 1/30	White	30mm Length
1805730000	SFC 1/30	Yellow	30mm Length
1805720000	SFC 1/30	Blue	30mm Length
1805740000	SFC 1/30	Red	30mm Length
1805870000	SFC 2/30	White	30mm Length
1805830000	SFC 2/30	Yellow	30mm Length
1805820000	SFC 2/30	Blue	30mm Length
1805850000	SFC 2/30	Red	30mm Length

Installation Products - Wire & Cable

Qty. per box	Char. per tag using Font 10	Ext. diameter of wire (mm)	AWG	Cross-section (mm ²)	
200	5 Characters	1.5 mm - 2.5 mm	20 - 16 AWG	0.5 mm ² - 1.0 mm ²	
200	5 Characters	1.5 mm - 2.5 mm	20 - 16 AWG	0.5 mm ² - 1.0 mm ²	
200	5 Characters	1.5 mm - 2.5 mm	20 - 16 AWG	0.5 mm ² - 1.0 mm ²	
200	5 Characters	1.5 mm - 2.5 mm	20 - 16 AWG	0.5 mm ² - 1.0 mm ²	
200	5 Characters	2.0 mm - 3.5 mm	18 - 12 AWG	0.75 mm ² - 2.5 mm ²	
200	5 Characters	2.0 mm - 3.5 mm	18 - 12 AWG	0.75 mm ² - 2.5 mm ²	
200	5 Characters	2.0 mm - 3.5 mm	18 - 12 AWG	0.75 mm ² - 2.5 mm ²	
200	5 Characters	2.0 mm - 3.5 mm	18 - 12 AWG	0.75 mm ² - 2.5 mm ²	
120	5 Characters	2.5 mm - 5.0 mm	12 - 10 AWG	2.5 mm ² - 4.0 mm ²	
120	5 Characters	2.5 mm - 5.0 mm	12 - 10 AWG	2.5 mm ² - 4.0 mm ²	
120	5 Characters	2.5 mm - 5.0 mm	12 - 10 AWG	2.5 mm ² - 4.0 mm ²	
120	5 Characters	2.5 mm - 5.0 mm	12 - 10 AWG	2.5 mm ² - 4.0 mm ²	
200	10 Characters	1.5 mm - 2.5 mm	20 - 16 AWG	0.5 mm ² - 1.0 mm ²	
200	10 Characters	1.5 mm - 2.5 mm	20 - 16 AWG	0.5 mm ² - 1.0 mm ²	
200	10 Characters	1.5 mm - 2.5 mm	20 - 16 AWG	0.5 mm ² - 1.0 mm ²	
200	10 Characters	1.5 mm - 2.5 mm	20 - 16 AWG	0.5 mm ² - 1.0 mm ²	
200	10 Characters	2.0 mm - 3.5 mm	18 - 12 AWG	0.75 mm ² - 2.5 mm ²	
200	10 Characters	2.0 mm - 3.5 mm	18 - 12 AWG	0.75 mm ² - 2.5 mm ²	
200	10 Characters	2.0 mm - 3.5 mm	18 - 12 AWG	0.75 mm ² - 2.5 mm ²	
200	10 Characters	2.0 mm - 3.5 mm	18 - 12 AWG	0.75 mm ² - 2.5 mm ²	
120	10 Characters	2.5 mm - 5.0 mm	12 - 10 AWG	2.5 mm ² - 4.0 mm ²	
120	10 Characters	2.5 mm - 5.0 mm	12 - 10 AWG	2.5 mm ² - 4.0 mm ²	
120	10 Characters	2.5 mm - 5.0 mm	12 - 10 AWG	2.5 mm ² - 4.0 mm ²	
120	10 Characters	2.5 mm - 5.0 mm	16 - 14 AWG	2.5 mm ² - 4.0 mm ²	
150	14 Characters	1.5 mm - 2.5 mm	20 - 16 AWG	0.5 mm ² - 1.0 mm ²	
150	14 Characters	1.5 mm - 2.5 mm	20 - 16 AWG	0.5 mm ² - 1.0 mm ²	
150	14 Characters	1.5 mm - 2.5 mm	20 - 16 AWG	0.5 mm ² - 1.0 mm ²	
150	14 Characters	1.5 mm - 2.5 mm	20 - 16 AWG	0.5 mm ² - 1.0 mm ²	
150	14 Characters	2.0 mm - 3.5 mm	18 - 12 AWG	0.75 mm ² - 2.5 mm ²	
150	14 Characters	2.0 mm - 3.5 mm	18 - 12 AWG	0.75 mm ² - 2.5 mm ²	
150	14 Characters	2.0 mm - 3.5 mm	18 - 12 AWG	0.75 mm ² - 2.5 mm ²	
150	14 Characters	2.0 mm - 3.5 mm	18 - 12 AWG	0.75 mm ² - 2.5 mm ²	
90	14 Characters	2.5 mm - 5.0 mm	12 - 10 AWG	2.5 mm ² - 4.0 mm ²	
90	14 Characters	2.5 mm - 5.0 mm	12 - 10 AWG	2.5 mm ² - 4.0 mm ²	
90	14 Characters	2.5 mm - 5.0 mm	12 - 10 AWG	2.5 mm ² - 4.0 mm ²	
90	14 Characters	2.5 mm - 5.0 mm	12 - 10 AWG	2.5 mm ² - 4.0 mm ²	

Installation Products - Protective Sleeves

TM-HF Sleeve

TM sleeves are halogen free and practically free from pollutants. The sleeves can be fitted with insert tags TM-I 12 or TM-I 18. They offer a wide range of applications for cables and wires. This system has proven particularly successful in traffic engineering. The slim design guarantees a secure attachment to the wire.



- Halogen-free
- Slim design guarantees secure attachment to the wire.

* NOTE: Use TM-I insert for marking

TMX-HF Sleeve

TMX rounds Weidmüller's extensive assortment of sleeves. By utilising cable ties, the transparent, halogen-free TMX sleeves can be fitted to any size of wire. The TMX sleeve is fitted with the insert tag TM-I 18. It is designed for a wide range of applications. The TMX sleeves are suitable for cables and wires with an external diameters from 15 mm and upwards. Cable ties guarantee secure attachment.



- Halogen-free
- Secure attachment with cable ties

* NOTE: Attach with cable ties - max. width of cable tie = 4.8 mm, use TM-I insert for marking

TM Twin Sleeve

Twin sleeves provide a two-side marking option of wires. They can be fitted with two TM-I 18 tags, so that input and output designations of a wire can be viewed from a single vantage point. The transparent, halogen-free sleeves can be used for external wire-insulation diameters from 1.3 to 4.0 mm.



* NOTE: Use TM-I insert for marking

WPT Sleeve

WPT wire and cable markers are high-quality, transparent markers available in various lengths for marking cables with cross-sections from 0.22 mm² to maximum 75 mm².

- Wider cross-section range per sleeve
- Wider application range thanks to special resilient bellow profile
- Marker tag inserts easily into marker pocket before and after wire is connected
- Available in five lengths and four sizes



* NOTE: Use TM-I insert for marking

Part Number	Description	Dimensions	Qty. per bag
1719760000	TM 0/12 HF	12mm Length	1000
1719780000	TM 1/12 HF	12mm Length	1000
1719800000	TM 2/12 HF	12mm Length	1000
1719820000	TM 3/12 HF	12mm Length	500
1719840000	TM 4/12 HF	12mm Length	500
1719860000	TM 5/12 HF	12mm Length	200
1719880000	TM 6/12 HF	12mm Length	200
1719770000	TM 0/18 HF	18mm Length	1000
1719790000	TM 1/18 HF	18mm Length	1000
1719810000	TM 2/18 HF	18mm Length	1000
1719830000	TM 3/18 HF	18mm Length	500
1719850000	TM 4/18 HF	18mm Length	500
1719870000	TM 5/18 HF	18mm Length	200
1719890000	TM 6/18 HF	18mm Length	200
1748820000	TMX	18mm Length	500
1841810000	TM 0/18 Twin HF/HB	18mm Length	500
1841780000	TM 1/18 Twin HF/HB	18mm Length	500
1764060000	WPT 02-12	12mm Length	200
1764070000	WPT 02-15	15mm Length	200
1764140000	WPT 02-18	18mm Length	200
1764150000	WPT 02-20	20mm Length	200
1889580000	WPT 02-30	30mm Length	200
1764190000	WPT 1-12	12mm Length	200
1764200000	WPT 1-15	15mm Length	200
1764210000	WPT 1-18	18mm Length	200
1764220000	WPT 1-20	20mm Length	200
1889560000	WPT 1-30	30mm Length	200
1764230000	WPT 2-12	12mm Length	200
1764240000	WPT 2-15	15mm Length	200
1764250000	WPT 2-18	18mm Length	200
1764260000	WPT 2-20	20mm Length	200
1889570000	WPT 2-30	30mm Length	200
1764270000	WPT 3-12	12mm Length	200
1764280000	WPT 3-15	15mm Length	200
1764290000	WPT 3-18	18mm Length	200
1764300000	WPT 3-20	20mm Length	200
1889550000	WPT 3-30	30mm Length	200

Installation Products - Protective Sleeves

Insert Tag *	Ext. diameter of wire (mm)	AWG	Cross-section (mm ²)		
TM-I 12	1.3 mm - 2.0 mm	20 AWG	0.22 mm ² - 0.5 mm ²		
TM-I 12	1.8 mm - 2.5 mm	18 - 14 AWG	0.5 mm ² - 1.5 mm ²		
TM-I 12	2.5 mm - 4.0 mm	16 - 12 AWG	0.75 mm ² - 2.5 mm ²		
TM-I 12	4.0 mm - 6.5 mm	12 - 8 AWG	2.5 mm ² - 6.0 mm ²		
TM-I 12	6.0 mm - 10.0 mm	6 - 1 AWG	10.0 mm ² - 35.0 mm ²		
TM-I 12	9.0 mm - 15.0 mm	2 - 0 AWG	25.0 mm ² - 70.0 mm ²		
TM-I 12	15.0 mm - 24.0 mm	1 - 0 AWG	35.0 mm ² - 150.0 mm ²		
TM-I 18	1.3 mm - 2.0 mm	20 AWG	0.22 mm ² - 0.5 mm ²		
TM-I 18	1.8 mm - 2.5 mm	18 - 14 AWG	0.5 mm ² - 1.5 mm ²		
TM-I 18	2.5 mm - 4.0 mm	16 - 12 AWG	0.75 mm ² - 2.5 mm ²		
TM-I 18	4.0 mm - 6.5 mm	12 - 8 AWG	2.5 mm ² - 6.0 mm ²		
TM-I 18	6.0 mm - 10.0 mm	6 - 1 AWG	10.0 mm ² - 35.0 mm ²		
TM-I 18	9.0 mm - 15.0 mm	2 - 0 AWG	25.0 mm ² - 70.0 mm ²		
TM-I 18	15.0 mm - 24.0 mm	1 - 0 AWG	35.0 mm ² - 150.0 mm ²		
TM-I 18	15 mm	4 - 1 AWG	up to 25 mm ²		
TM-I 18	1.3 mm - 2.6 mm	20 - 14 AWG	0.22 mm ² - 1.5 mm ²		
TM-I 18	2.4 mm - 4.0 mm	16 - 10 AWG	1.0 mm ² - 2.5 mm ²		
TM-I 12	1.3 mm - 3.0 mm	20 - 14 AWG	0.22 mm ² - 1.5 mm ²		
TM-I 15	1.3 mm - 3.0 mm	20 - 14 AWG	0.22 mm ² - 1.5 mm ²		
TM-I 18	1.3 mm - 3.0 mm	20 - 14 AWG	0.22 mm ² - 1.5 mm ²		
TM-I 20	1.3 mm - 3.0 mm	20 - 14 AWG	0.22 mm ² - 1.5 mm ²		
TM-I 30	1.3 mm - 3.0 mm	20 - 14 AWG	0.22 mm ² - 1.5 mm ²		
TM-I 12	2.5 mm - 5.0 mm	18 - 10 AWG	0.75 mm ² - 6.0 mm ²		
TM-I 15	2.5 mm - 5.0 mm	18 - 10 AWG	0.75 mm ² - 6.0 mm ²		
TM-I 18	2.5 mm - 5.0 mm	18 - 10 AWG	0.75 mm ² - 6.0 mm ²		
TM-I 20	2.5 mm - 5.0 mm	18 - 10 AWG	0.75 mm ² - 6.0 mm ²		
TM-I 30	2.5 mm - 5.0 mm	18 - 10 AWG	0.75 mm ² - 6.0 mm ²		
TM-I 12	4.0 mm - 10.0 mm	10 - 1 AWG	4.0 mm ² - 35.0 mm ²		
TM-I 15	4.0 mm - 10.0 mm	10 - 1 AWG	4.0 mm ² - 35.0 mm ²		
TM-I 18	4.0 mm - 10.0 mm	10 - 1 AWG	4.0 mm ² - 35.0 mm ²		
TM-I 20	4.0 mm - 10.0 mm	10 - 1 AWG	4.0 mm ² - 35.0 mm ²		
TM-I 30	4.0 mm - 10.0 mm	10 - 1 AWG	4.0 mm ² - 35.0 mm ²		
TM-I 12	8.0 mm - 16.0 mm	8 - 0 AWG	6.0 mm ² - 75.0 mm ²		
TM-I 15	8.0 mm - 16.0 mm	8 - 0 AWG	6.0 mm ² - 75.0 mm ²		
TM-I 18	8.0 mm - 16.0 mm	8 - 0 AWG	6.0 mm ² - 75.0 mm ²		
TM-I 20	8.0 mm - 16.0 mm	8 - 0 AWG	6.0 mm ² - 75.0 mm ²		
TM-I 30	8.0 mm - 16.0 mm	8 - 0 AWG	6.0 mm ² - 75.0 mm ²		

* See page F.20 for inserts

Installation Products - Protective Sleeves

WPM Sleeve

WPM is the right sleeve for larger wire cross-sections. The transparent sleeve pocket protects the insert tags against environmental conditions. The transparent WPM sleeves are securely attached using cable ties. TM-I 18 for WPM 10/33 or ESG 9/17 for WPM 20/33 provide the markings. Both insert tags have been designed in the proven MultiCard format for convenient printing with PrintJet and Plotter. The tag PF 2/17.5 is suitable for the WPM 20/66.



- Secure attachment with cable ties
- Professional printing assured thanks to Weidmüller's printing system for MultiCards

* NOTE: Attach using cable ties

WKM Sleeve

Providing secure attachment to the wire or cable, WKM is the right marker for tough conditions. The transparent sleeve pocket guarantees reliable protection of the marking in tough environmental conditions. Cable tie attachment facilitates their use with practically all wire cross-sections. WKM provides numerous markings options, for example, laser print, matrix print or STI marking pen on paper or polyester labels.



* NOTE: Attach using cable ties

Technical Data

Material: TM-HF, TMX-HF, TM Twin Sleeve - Polyethylene, WPT - Soft PVC, WPM - PVC, WKM - Polypropylene
 Flammability class to UL94 V2 (Unless specified V0 in product description)
 Temperature range: TM-HF, TMX-HF, TM Twin Sleeve -20 to 80°C, WPT -30 to 80°C, WPM -30 to 60°C, WKM -40 to 80°C .

Possible printing systems: Plotter and PrintJet

Notes on mounting:

- TM-HF, TM Twin Sleeve, WPT: Slide onto unconnected wires
- TMX-HF, WPM, WKM: Attach using cable ties

Ordering data

Attach to unconnected wires using and connected wires
 Custom and standard pre-printed markers available.

Part Number	Description	Dimensions	Qty. per bag
1763270000	WPM 10/33	33mm Length, Width 6mm	100
1763280000	WPM 20/33	33mm Length, Width 11.3mm	100
1763390000	WPM 20/66	66mm Length, Width 11.3mm	50
1753490000	WKM 8/20	20mm Length, Width 8mm	50
1631910000	WKM 8/30	30mm Length, Width 8mm	50
1610700000	WKM 18/43	43mm Length, Width 18mm	50

Installation Products - Protective Sleeves

ESG Insert

ESG is the proven marker in MultiCard format for many well-known electrical devices. The result is high-quality device markings with a contrast-rich appearance.

We offer versions for the devices produced by the following manufacturers:

- ABB
- Siemens
- Moeller
- Télémécanique
- For universal use, self-adhesive or clip-on tags are available (depending on the type)

ESG for clipping onto tag rails; suitable for devices mounted in rows, such as miniature circuit-breakers.



WPF Insert

WPF insert tags are made from a halogen-free polyester material. The perforated edges ensure the tags can easily be separated from the A4 sheets in which they are supplied. The pre-print treated material guarantees rapid and permanent marking by means of laser, matrix print.



TM-I Insert

Easy to fit and secure attachment thanks to the special contour of the TM-I. They are compatible with numerous commercially available sleeves. The MultiCard format means that the tags can be rapidly and easily printed with the printing systems, PrintJet, Plotter, or the STI pen. Thanks to the project marker surface of the MultiCard, they can easily be separated and then attached. There are five marker lengths available for custom prints with long sequences of characters.

- Project marker surface for easy separation & attachment
- Approved and listed markers for traffic engineering
- Top flexibility through advanced attachment of sleeve and retrospective fitting of tags

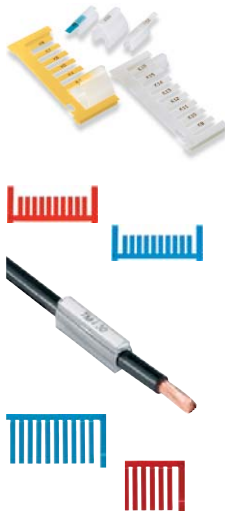

Technical Data

Material: ESG, TM-I - Polyamide - halogen-free, ESO - Paper or Polyester, WPF - Polyester foil - halogen-free
 Flammability class to UL94 V2 (Unless specified V0 in product description)
 Temperature range: ESG, TM-I -40 to 100°C, WPF -30 to 120°C, ESO -40 to 80°C.

Possible printing systems: ESO, WPF - Laser Printer, ESG, TM-I - Plotter and PrintJet

Notes on mounting:

- Insert into protective sleeve

Ordering data

Custom and standard pre-printed markers available.

Part Number	Description	Colour	Dimensions
1736181044	ESG 7/20	White	20mm Length, Width 7mm
1724760000	ESG 9/17	White	17mm Length, Width 9mm
1607720000	ESO 7 - Paper	White	6.3mm Length, Width 27mm
1634780000	ESO 7 - Paper	Yellow	6.3mm Length, Width 27mm
1670390000	ESO 7 - Polyester	White	6.3mm Length, Width 27mm
1670400000	ESO 7 - Polyester	Yellow	6.3mm Length, Width 27mm
1607710000	ESO 5 - Paper	White	16.5mm Length, Width 40mm
1631350000	ESO 5 - Paper	Yellow	16.5mm Length, Width 40mm
1670370000	ESO 5 - Polyester	White	16.5mm Length, Width 40mm
1670380000	ESO 5 - Polyester	Yellow	16.5mm Length, Width 40mm
1919890000	ESO 8/20 Paper	White	20mm Length, Width 7mm
1919900000	ESO 8/20 Paper	Yellow	20mm Length, Width 7mm
1919870000	ESO 8/20 Polyester	White	20mm Length, Width 7mm
1919880000	ESO 8/20 Polyester	Yellow	20mm Length, Width 7mm
1764050000	WPF 2/17.5	White	17.5mm Length
1600740000	WPF 1/20	White/Yellow	20mm Length
1718411044	TM-I 12	White	12mm Length, 4mm Width
1718411686	TM-I 12	Red	12mm Length, 4mm Width
1718411687	TM-I 12	Yellow	12mm Length, 4mm Width
1718411688	TM-I 12	Green	12mm Length, 4mm Width
1718411693	TM-I 12	Blue	12mm Length, 4mm Width
1609981044	TM-I 15	White	15mm Length, 4mm Width
1609981686	TM-I 15	Red	15mm Length, 4mm Width
1609981687	TM-I 15	Yellow	15mm Length, 4mm Width
1609981688	TM-I 15	Green	15mm Length, 4mm Width
1609981693	TM-I 15	Blue	15mm Length, 4mm Width
1718431044	TM-I 18	White	18mm Length, 4mm Width
1718431686	TM-I 18	Red	18mm Length, 4mm Width
1718431687	TM-I 18	Yellow	18mm Length, 4mm Width
1718431688	TM-I 18	Green	18mm Length, 4mm Width
1718431693	TM-I 18	Blue	18mm Length, 4mm Width
1680411044	TM-I 20	White	20mm Length, 4mm Width
1680411686	TM-I 20	Red	20mm Length, 4mm Width
1680411687	TM-I 20	Yellow	20mm Length, 4mm Width
1680411688	TM-I 20	Green	20mm Length, 4mm Width
1680411693	TM-I 20	Blue	20mm Length, 4mm Width
1876390000	TM-I 30	White	30mm Length, 4mm Width
1876380000	TM-I 30	Red	30mm Length, 4mm Width
1876370000	TM-I 30	Yellow	30mm Length, 4mm Width
1876400000	TM-I 30	Blue	30mm Length, 4mm Width

Installation Products - Protective Sleeves

Qty. per box	Char. per tag using Font 10	Fits Into		
200	10 Characters	WPM		
200	8 Characters	WPM		
1 Sheet (240 Tags)	4 Characters	WKM		
1 Sheet (240 Tags)	4 Characters	WKM		
1 Sheet (240 Tags)	4 Characters	WKM		
1 Sheet (240 Tags)	4 Characters	WKM		
1 Sheet (60 Tags)	8 Characters	WKM		
1 Sheet (60 Tags)	8 Characters	WKM		
1 Sheet (60 Tags)	8 Characters	WKM		
1 Sheet (60 Tags)	8 Characters	WKM		
1 Sheet (342 Tags)	5 Characters	WKM		
1 Sheet (342 Tags)	5 Characters	WKM		
1 Sheet (342 Tags)	5 Characters	WKM		
1 Sheet (342 Tags)	5 Characters	WKM		
1 Sheet (352 Tags)	8 Characters	WPT, WPM		
1 Sheet (594 Tags)	10 Characters	WPT, WPM		
320	5 Characters	TM-HF, TMX-HF TM Twin Sleeve, WPT, WPM		
320	5 Characters	TM-HF, TMX-HF TM Twin Sleeve, WPT, WPM		
320	5 Characters	TM-HF, TMX-HF TM Twin Sleeve, WPT, WPM		
320	5 Characters	TM-HF, TMX-HF TM Twin Sleeve, WPT, WPM		
320	5 Characters	TM-HF, TMX-HF TM Twin Sleeve, WPT, WPM		
400	7 Characters	TM-HF, TMX-HF TM Twin Sleeve, WPT, WPM		
400	7 Characters	TM-HF, TMX-HF TM Twin Sleeve, WPT, WPM		
400	7 Characters	TM-HF, TMX-HF TM Twin Sleeve, WPT, WPM		
400	7 Characters	TM-HF, TMX-HF TM Twin Sleeve, WPT, WPM		
400	7 Characters	TM-HF, TMX-HF TM Twin Sleeve, WPT, WPM		
320	8 Characters	TM-HF, TMX-HF TM Twin Sleeve, WPT, WPM		
320	8 Characters	TM-HF, TMX-HF TM Twin Sleeve, WPT, WPM		
320	8 Characters	TM-HF, TMX-HF TM Twin Sleeve, WPT, WPM		
320	8 Characters	TM-HF, TMX-HF TM Twin Sleeve, WPT, WPM		
320	8 Characters	TM-HF, TMX-HF TM Twin Sleeve, WPT, WPM		
400	9 Characters	TM-HF, TMX-HF TM Twin Sleeve, WPT, WPM		
400	9 Characters	TM-HF, TMX-HF TM Twin Sleeve, WPT, WPM		
400	9 Characters	TM-HF, TMX-HF TM Twin Sleeve, WPT, WPM		
400	9 Characters	TM-HF, TMX-HF TM Twin Sleeve, WPT, WPM		
400	9 Characters	TM-HF, TMX-HF TM Twin Sleeve, WPT, WPM		
300	14 Characters	TM-HF, TMX-HF TM Twin Sleeve, WPT, WPM		
300	14 Characters	TM-HF, TMX-HF TM Twin Sleeve, WPT, WPM		
300	14 Characters	TM-HF, TMX-HF TM Twin Sleeve, WPT, WPM		
300	14 Characters	TM-HF, TMX-HF TM Twin Sleeve, WPT, WPM		

Installation Products

F

Installation Products - Equipment Markers

ESG	Part Number	Description	Colour	Dimensions
<p>ESG is the proven marker in MultiCard format for many well-known electrical devices. The result is high-quality device markings with a contrast-rich appearance.</p> <p>We offer versions for the devices produced by the following manufacturers:</p> <ul style="list-style-type: none"> • ABB • Siemens • Moeller • Télémécanique <p>For universal use, self-adhesive or clip-on tags are available (depending on the type)</p> <p>ESG for clipping onto tag rails; suitable for devices mounted in rows, such as miniature circuit-breakers.</p>	1919940000	ESG 5/10 MC	White	10mm Length, 5mm Width
	1880130000	ESG 6/15 K MC	Yellow	15mm Length, 6mm Width
	1880100000	ESG 6/15 K MC	White	15mm Length, 6mm Width
	1881280000	ESG 6/15 K MC - RIDERSERIES	White	15mm Length, 6mm Width
	1880110000	ESG 6/17 K MC	Yellow	17mm Length, 6mm Width
	1880120000	ESG 6/17 K MC	White	17mm Length, 6mm Width
	1736181687	ESG 7/20 SIRIUS MC	Yellow	20mm Length, 7mm Width
	1736181044	ESG 7/20 SIRIUS MC	White	20mm Length, 7mm Width
	1736181696	ESG 7/20 SIRIUS MC	Turquoise	20mm Length, 7mm Width
	1736190000	ESG 8/10 ASI	White	10mm Length, 8mm Width
	1674740000	ESG 8/17 MC	White	17mm Length, 8mm Width
	1755340000	ESG 8/17 SYS PRO M	White	17mm Length, 8mm Width
	1720610000	ESG 8/17 SCHS MC	White	17mm Length, 8mm Width
	1890470000	ESG 8/17 L MC	White	17mm Length, 8mm Width
	1652220000	ESG 8/19 MC	White	19mm Length, 8mm Width
	1775910000	ESG 9/10 MC	White	10mm Length, 9mm Width
	1857440000	ESG 9/11 K MC	White	11mm Length, 9mm Width
	1753500000	ESG 9/17 K MC	Yellow	17mm Length, 9mm Width
	1674760000	ESG 9/17 K MC	White	17mm Length, 9mm Width
	1856700000	ESG 10/17 MC	White	17mm Length, 10mm Width
	1890460000	ESG 9/20 L MC	White	20mm Length, 9mm Width
	1766160000	ESG 9/20 K MC	Yellow	20mm Length, 9mm Width
	1609940000	ESG 9/20 K MC	White	20mm Length, 9mm Width
	1856720000	ESG 9/20 MC Universal	Transparent	20mm Length, 9mm Width
	0138900000	Tag rail SchS1	Black	1m Length
	0337400000	Tag rail SchS2	Black	1m Length
	1720600000	Tag rail SchS2, self-adhesive	Black	1m Length
	1753480000	Tag rail SchS3, self-adhesive	White	1m Length
1753460000	Tag rail SchS3, self-adhesive	Grey	1m Length	
0139000000	ESO/SCHS1	White	0.5m Length, 12.5mm Width	
0139200000	STR SCHS1	Transparent	0.5m Length, 12.5mm Width	

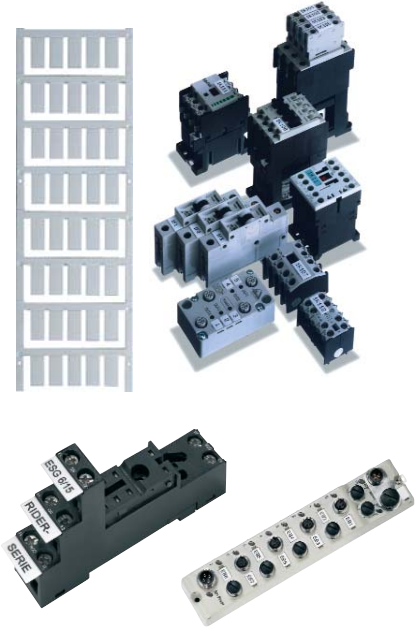

Tag Rail



Installation Products - Equipment Markers

Qty. per box	Char. per tag using Font 10	Application		
400	5 Characters	Turck/Beckhoff SAI distributor		
200	7 Characters	Self-adhesive		
200	7 Characters	Self-adhesive		
200	7 Characters	Riderseries SCM/SRC		
200	8 Characters	Self-adhesive		
200	8 Characters	Self-adhesive		
200	9 Characters	Siemens 3R / tag rail SchS3/4		
200	9 Characters	Siemens 3R / tag rail SchS3/4		
200	9 Characters	Siemens 3R / tag rail SchS3/4		
200	4 Characters	Siemens AS-interface		
200	8 Characters	Télemécanique		
200	8 Characters	GE power Controls (AEG) ABB-Stotz		
200	8 Characters	Tag rail SchS2		
200	8 Characters	Lumberg distributor (SAI)		
200	9 Characters	AEG		
200	4 Characters			
200	4 Characters	Self-adhesive		
200	8 Characters	Self-adhesive		
200	8 Characters	Self-adhesive		
200	8 Characters	Allen Bradley / Festo MT		
200	9 Characters	Lumberg distributor		
200	9 Characters	Siemens + Moeller+WI SAI distributor		
200	9 Characters	Siemens + Moeller+WI SAI distributor		
200	9 Characters	Siemens + Moeller+WI and		
1m		for ESO with protective strip		
1m		for ESG 18/17 S DEK WS		
1m		for ESG 18/17 S DEK WS		
1m		for ESG 7/20		
1m		for ESG 7/20		
0.5m		Insert strips for SCHS1		
0.5m		Protective strip for SCHS1		

Installation Products

F

Installation Products - Equipment Markers

SwitchMark (SM)

SwitchMark (SM) markers are used to identify command and signalling devices. The tags are either snapped into the holder or secured by means of the self-adhesive foil on their rear. Individual custom prints can be created using the printing system, PrintJet or Plotter.

- Create individual custom prints utilising Weidmüller's marking system for MultiCards.
- Fast production of custom prints to in-house specifications.
- No need to store expensive standard tags.
- Extremely resistant print quality with PrintJet instead of engraving.
- We recommend the protective foil ETO SM for extreme conditions.



F

SwitchMark Accessories - Holders (SM-H)

The device and installation markers are either snapped into the holder or secured by means of the self-adhesive foil on their rear.

- For example: insert the SM 27/18 into the holder that we offer as well as the markers
- We recommend that the transparent protective foil ETO SM be used if the print is subjected to extreme demands with respect to their wipe and scratch resistance in the presence of chemicals



*Note: For ø22mm push buttons

SwitchMark Accessories - Protective Foils (ETO-SM)



*Note: Details in round brackets indicate the number of markers per sheet

ClipCard (CC)

ClipCard device markers in MultiCard format offer an interesting alternative to engraving. This assortment is used to mark electrical installations and switchgear. The proven MultiCard format means it is possible to print with any of the PrintJet and Plotter printers.

- Extremely resilient print quality with PrintJet instead of engraving
- Universal attachment
 - Holder (screw attachment or with cable tie)
 - Tag rail (self-adhesive and screw attachment)
 - or self-adhesive markers

Part Number	Description	Colour	Dimensions
1699840000	SM 27/12.5	White	27mm Length, 12.5mm Width
1713700000	SM 27/12.5	Silver	27mm Length, 12.5mm Width
1699860000	SM 27/18	White	27mm Length, 18mm Width
1713740000	SM 27/18	Silver	27mm Length, 18mm Width
1773220000	SM 27/27	White	27mm Length, 27mm Width
1773230000	SM 27/27	Silver	27mm Length, 27mm Width
1812630000	SM 27/8 K	White	27mm Length, 8mm Width
1771930000	SM 27/8 K	Silver	27mm Length, 8mm Width
1699880000	SM 27/12.5 K	White	27mm Length, 12.5mm Width
1713720000	SM 27/12.5 K	Silver	27mm Length, 12.5mm Width
1707270000	SM 27/18 K	White	27mm Length, 18mm Width
1713760000	SM 27/18 K	Silver	27mm Length, 18mm Width
1877570000	SM 22/22 K	White	22mm Length, 22mm Width
1877590000	SM 22/22 K	Silver	22mm Length, 22mm Width
1783000000	SM 27/27 K	White	27mm Length, 27mm Width
1782990000	SM 27/27 K	Silver	27mm Length, 27mm Width
1716640000	SM-H 27/12.5		41.6mm Length, 29.5mm Width
1716630000	SM-H 27/18		49.8mm Length, 29.5mm Width
1782710000	SM-H 27/27		59.3mm Length, 29.5mm Width
1812630000	ETO SM 27/8		27mm Length, 8mm Width
1699880000	ETO SM 27/12.5		27mm Length, 12.5mm Width
1707270000	ETO SM 27/18		27mm Length, 18mm Width
1877570000	ETO SM 22/22		22mm Length, 22mm Width
1783000000	ETO SM 27/27		27mm Length, 27mm Width
1876570000	CC 15/17 MC	White	17mm Length, 15mm Width
1876610000	CC 15/17 MC	Silver	17mm Length, 15mm Width
1876770000	CC 15/27 MC	White	27mm Length, 15mm Width
1876760000	CC 15/27 MC	Silver	27mm Length, 15mm Width
1877260000	CC 15/49 MC	White	49mm Length, 15mm Width
1877240000	CC 15/49 MC	Silver	49mm Length, 15mm Width

Installation Products -Equipment Markers

Qty. per box	Char. per tag using Font 10	Application		
80		SM-H 27/12.5		
80		SM-H 27/12.5		
80		SM-H 27/18		
80		SM-H 27/18		
60		SM-H 27/27		
60		SM-H 27/27		
80		Self-adhesive		
80		Self-adhesive		
80		Self-adhesive		
80		Self-adhesive		
80		Self-adhesive		
80		Self-adhesive		
80		Self-adhesive		
80		Self-adhesive		
80		Self-adhesive		
60		Self-adhesive		
60		Self-adhesive		
25		SM 27/12.5		
25		SM 27/18		
20		SM 27/27		
1 (165)		SM 27/8, SM 27/8 K		
1 (100)		SM 27/12.5, SM 27/12.5 K		
1 (112)		SM 27/18, SM 27/18 K		
1 (112)		SM 22/22 K		
1 (70)		SM 27/27, SM 27/27 K		
80		CC-H 15/17		
80		CC-H 15/17		
80		CC-H 15/27		
80		CC-H 15/27		
40		CC-H 15/49		
40		CC-H 15/49		

Installation Products

F

Installation Products - Equipment Markers

ClipCard (CC) - continued

- For extreme conditions, we recommend:
 - Protective strips (holder)
 - Protective rail (CC-Rail)
 - Protective foil for markers



Part Number	Description	Colour	Dimensions
1877350000	CC 15/60 MC	White	60mm Length, 15mm Width
1877340000	CC 15/60 MC	Silver	60mm Length, 15mm Width
1934420000	CC 30/60 MC	White	60mm Length, 30mm Width
1934400000	CC 30/60 MC	Silver	60mm Length, 30mm Width
1876590000	CC 15/17 K MC	White	17mm Length, 15mm Width
1876580000	CC 15/17 K MC	Silver	17mm Length, 15mm Width
1876640000	CC 15/27 K MC	White	27mm Length, 15mm Width
1876780000	CC 15/27 K MC	Silver	27mm Length, 15mm Width
1877220000	CC 15/49 K MC	White	49mm Length, 15mm Width
1877270000	CC 15/49 K MC	Silver	49mm Length, 15mm Width
1877310000	CC 15/60 K MC	White	60mm Length, 15mm Width
1877360000	CC 15/60 K MC	Silver	60mm Length, 15mm Width
1934390000	CC 30/60 K MC	White	60mm Length, 30mm Width
1934330000	CC 30/60 K MC	Silver	60mm Length, 30mm Width

F

ClipCard - Holders (CC-H)

Universal attachment options with the possibility of being mounted either in a holder, per cable tie or screw as well as by utilising CC-Rail tag rails.

- Universal attachment options: per holder, cable tie or screw as well as by means of a tag rail
- For extreme conditions, we recommend:
 - Protective strips (holder)
 - Protective rail (CC-Rail)
 - Protective foil for markers



1790430000	CC-H 15/17	Black	
1790410000	CC-H 15/27	Black	
1790420000	CC-H 15/49	Black	
1878910000	CC-H 15/60	Black	
1934430000	CC-H 30/60	Black	

ClipCard - Protective Strips (STR CC)



1888310000	STR CC 15/17	Transparent	17mm Length, 15mm Width
1888290000	STR CC 15/27	Transparent	27mm Length, 15mm Width
1888300000	STR CC 15/49	Transparent	49mm Length, 15mm Width
1888280000	STR CC 15/60	Transparent	60mm Length, 15mm Width
1934450000	STR CC 30/60	Transparent	60mm Length, 30mm Width

ClipCard - Protective Foils & Tag Rail (ETO CC)



*NOTE: Details in round brackets indicate the number of markers per sheet

1880850000	ETO CC 15/17	Transparent	17mm Length, 15mm Width
1880810000	ETO CC 15/27	Transparent	27mm Length, 15mm Width
1880830000	ETO CC 15/49	Transparent	49mm Length, 15mm Width
1880840000	ETO CC 15/60	Transparent	60mm Length, 15mm Width
1934440000	ETO CC 30/60	Transparent	60mm Length, 30mm Width

Technical Data

Material: ESG - Polyamide halogen-free, SwitchMark - Polyamide 66 halogen-free, ClipCard - Polyamide 66 halogen-free
 Flammability class to UL94 V2 (Unless specified V0 in product description)
 Temperature range: -40 to 100°C
 Adhesive force on stainless steel: K = normal adhesive 22 N/m
 Possible printing systems: Plotter and PrintJet

Ordering data

Custom and standard pre-printed markers available.

1790150000	CC-Rail 1000	Black	1 m Length
1790160000	CC-Rail 1000	Transparent	1 m Length

Installation Products - Equipment Markers

Qty. per box	Char. per tag using Font 10	Application		
40	27 Characters	CC-H 15/60		
40	27 Characters	CC-H 15/60		
30	27 Characters	CC-H 30/60		
30	27 Characters	CC-H 30/60		
80	8 Characters	Self-adhesive		
80	8 Characters	Self-adhesive		
80	12 Characters	Self-adhesive		
80	12 Characters	Self-adhesive		
40	20 Characters	Self-adhesive		
40	20 Characters	Self-adhesive		
40	27 Characters	Self-adhesive		
40	27 Characters	Self-adhesive		
30	27 Characters	Self-adhesive		
30	27 Characters	Self-adhesive		
75		CC 15/17 MC		
45		CC 15/27 MC		
25		CC 15/49 MC		
25		CC 15/60 MC		
10		CC 30/60 MC		
80		CC 15/17 MC, CC-H 15/17		
80		CC 15/27 MC, CC-H 15/27		
40		CC 15/49 MC, CC-H 15/49		
40		CC 15/60 MC, CC-H 15/60		
10		CC 30/60 MC, CC-H 30/60		
1 (228)		CC 15/17 MC		
1 (133)		CC 15/27 MC		
1 (76)		CC 15/49 MC		
1 (57)		CC 15/60 MC		
1 (27)		CC 30/60 MC		
1		CC 15/17 MC, CC 15/27 MC, CC 15/49 MC, CC 15/60 MC		
1		CC-Rail 1000		

Installation Products - Printers

PrintJet II

The **PrintJet** printer allows you to print customised marker prints for terminal blocks, switchgear, cables, wires and circuit-breakers at your convenience.

- Sharp print contours
- High-contrast typeface
- Extremely resilient lettering
- Permanently readable identification
- Fast and user friendly
- Compatible with all MultiCards
- The PrintJet-Loader holds up to 20 MultiCards



Technical data

Type	PrintJet II
Application	Prints MultiCard markers
Technology	Ink-jet process
Print quality	2880 dpi
Printer drivers	Win 9X, Win NT, Windows 2000
Print software	Recommended: M-Print 1.60
System requirements	Windows 95/98/NT/2000/XP
Feed	Manual or with optional loader
Fusing	Thermal fusing
Interface	Centronics and USB
Connection	AC 230 V/AC 115 V
Location	Office conditions
Ambient temperature	20 °C – 35 °C
Dimensions (L x W x H)	800 x 450 x 200 mm
Cartridge system	Ink cartridge, black (210 000 characters, Arial font size 6); average print performance per day: 20 MultiCards; max. print performance per day: 100 MultiCards
Range of supply	PrintJet printer, power cable, printer drivers, manuals (CD), cleaning unit, Centronics cable, software M-Print

PrintJet-Loader

System requirements	PrintJet printer
Marker types	MultiCard format
Operating voltage	12 V/DC
Current input	approx. 1 A
Interface	Connection via plug-in connector
Location	Office conditions
Ambient temperature	20 °C – 35 °C
Dimensions (L x W x H)	345 x 305 x 155 mm
Weight	4 kg

Ordering data

Type	PrintJet II Order No.
PrintJet II 115 V	1858980000
PrintJet-Loader	1813090000
Accessories	
Ink cartridge PrintJet II	1858920000
Clean Unit PrintJet II	1858950000

MCP Plus

Plotter complements the Weidmüller MultiCard concept. It is suitable for smaller quantities of markers and when only part of a MultiCard is to be printed on. The special positioning frame for five MultiCards increases productivity by 20 % over comparable systems. With the positioning frame for SlimFix markers sizes 4 to 6, printing on more than 120 MultiCard types for terminals, cables, wires and equipment is possible. Labels are printed with the MCP-Label positioning frame. Suitable for use with the Weidmüller **M-Print® PRO** software.

- 2 positioning frames for more than 120 MultiCard types
- MultiCards easily fitted into the frame
- Easy to use with partly used MultiCards
- Automatic pen activation function
- Safe storage of the plotter pens

Plotter

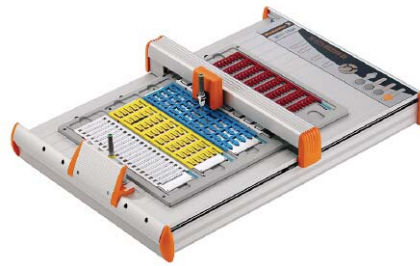

MCP Plus

Technical data

Type	Plotter
Application	printing of MultiCard markers and labels
Technology	plotting technique
Print software	M-Print® PRO
System requirements	Windows 95/98/NT/2000/XP
Interface	Parallel Centronics, USB
Power supply	230/115 V AC
Feed	manual
Location	office conditions
Ambient	temperature 10 °C – 35 °C
Dimensions (L x W x H)	660 x 440 x 125 mm
Weight	approx. 8 kg
Scope of supply	MCP Plus with Centronics cable, power pack (100-240 V AC/ 50-60 Hz), Euro and US plugs, MultiCard positioning frame, 0,25 mm plotter pen, M-Print® PRO software and manual

Ordering data

Type	MCP Plus Order no.
MCP Plus plotter set	1925000000

Ordering data

Type	For	Qty	MCP positioning frames Order no.
MCP pos. frame	MultiCards	1	1924360000
MCP pos. frame	SF 4-6 SlimFix sizes 4 to 6	1	1924310000
MCP pos. frame	Labels	1	1924370000

Ordering data

Type	For	Qty	MCP plotter pens Order no.
Plotter pen 0.18	Reusable pen	1	1768570000
Plotter pen 0.25	Reusable pen	1	1768540000
Plotter pen 0.25	P ink Disposable pen 8 ml	1	1920640000
Plotter pen 0.35	Reusable pen	1	1768550000
Plotter pen 0.35	P ink Disposable pen 8 ml	1	1920650000
Plotter pen 0.50	Reusable pen	1	1768560000

Ordering data

Type	Qty	Order no.	MCP ink
P ink	22 ml	1	1924340000
MCD ink	22 ml	1	1684470000

Ordering data

Type	Qty	Order no.	MCP miscellaneous
P cleaner	22 ml	1	1924330000
MCD cleaner	22 ml	1	1684460000
MCP cover		1	1924350000

Ordering data

Type	Qty	Order no.	STI pen
Adapter aluminium STI pen	1	1762440000	
STI pen SW	10	0508400000	



Adapter for STI-S



STI-S pen with adapter

Installation Products - Software

M-Print®

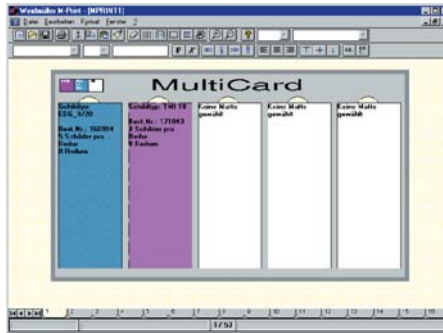

M-Print® PRO Label Designer

Print and ordering software for markers and labels.

M-Print® PRO is a professional software for printing and ordering Weidmüller markers and labels under Windows®. This software helps you to optimise your processes for marking electrical equipment. You can design, print and order your marking material effortlessly, professionally and quickly: texts, frames, lines, graphics, barcodes, serial numbers and photos.

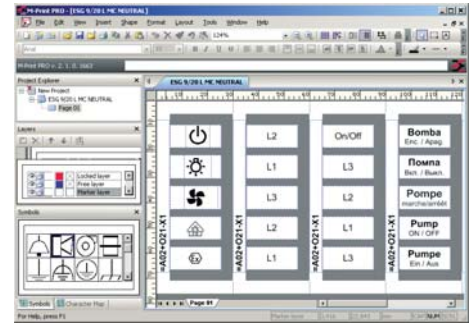

M-Print

- The software solution for labelling markers or labels and for cutting own label formats. .

M-Print is the universal labelling program for plotters and printers.

In conjunction with the MCP Plus Plotter and the PrintJet, all MultiCard varieties can be printed.

All configurations are clearly divided into 3 different areas. There is a choice of conductor markers, equipment markers and terminal markers. Data input is simplified through the MC mat, presented in its original form. All TrueType fonts can be used if the text information output is on a Windows printer.

The most up-to-date versions of the program may be found on the Internet at www.m-print.de

M-Print makes marking easy.

Ordering data

Type	Order No.
M-Print (multilingual version)	1784560000

Only software available in 16 bit format for use on old operating Windows systems. (Administrative rights reserved for NT and above versions).

Here is an overview of the main functions:

- Integrated product catalogue for all labels and markers, including images and links to the relevant web pages and product data sheets
- Markers and labels can be designed in as many levels as required
- Custom formatting of individual text characters (RTF)
- Perform copy-and-paste functions with texts and their formats
- Supports UNICODE for foreign-language texts, such as Russian, Chinese, Polish, etc.
- Enter data in labels and table sheet
- Permanent print preview: see how the printout will look during design phase
- Alphanumeric counts and sequences
- Extensive range of image formats (*.bmp, *.wmf, *.png, *.ico, *.jpeg, *.tif, *.gif)
- Image library including all of the important symbols used in electrical engineering
- Assign product to specific printer; for example, ESG 9/20 to PrintJet, LaserMark to laser printer, etc.
- Supported output devices: PrintJet II, ThermoCard, THM as well as standard printers with Windows drivers
- Optimum and rapid adjustment of the output devices
- Online update service via Internet
- Interface to RailDesigner®
- Import assistant to create your own import filter for numerous file formats (*.txt, *.asc, *.mak, *.wei, *.tmf, etc.)
- Integrates data from CAE systems

Supported operating systems:

WINDOWS® 98 SE, ME, NT, 2000, XP

System requirements:

- RAM: > 64 MB
- Processor: > Pentium III or comparable model
- Graphic: > 800 x 600 pixels with 256 colours optimum: 1024 x 768 with 16-bit High Colour
- Hard disk: > 90 MB free storage
- Miscellaneous: mouse, keyboard, CD-ROM drive (to install the software)

M-Print® PRO is available in two editions:

M-Print® PRO Standard Edition for professional printing results with all of Weidmüller's marking materials

M-Print® PRO Advanced Edition for professional printing results with all of Weidmüller's marking materials and customer specific labels

Ordering data

Type	Order No.
M-Print® PRO	1905490000

For planning and ordering rail assemblies.



When it comes to optimizing planning and ordering terminal rail assemblies, Weidmüller's RailDesigner software has proven itself to be a real time saver. True-to-detail display of products and an easy-to-use graphic user interface distinguish Weidmüller's RailDesigner software from other packages.

RailDesigner software provides you with:

- Complete product information and search functions that enable the user to quickly and easily select the necessary products through intelligent database queries and product libraries.
- Product libraries that can be customized to contain products Weidmüller offers for your specific requirements.
- Product images in flat and expanded views; add them to the rail assembly with the click of a mouse or the touch of a button.

And with the RailDesigner software, you won't make a mistake because errors are quickly detected and brought to the user's attention via the "Installation" function. Weidmüller's RailDesigner software is easy to learn and comes with a multimedia tutorial.

Advantages:

- Graphics user guidance and true-to-detail user interface
- On-line updates and service
- Intuitive commands through Windows® standard functions and clear menu structure
- Quick article selection through intelligent database queries and article libraries
- Ordering of terminal rails directly by email
- Multimedia tutorial for self-instruction
- Export/import interface to standard file formats (i.e. DXF, ASCII, Bitmap, etc.)
 - Bitmap export allows anyone to view a design with standard photo editing software

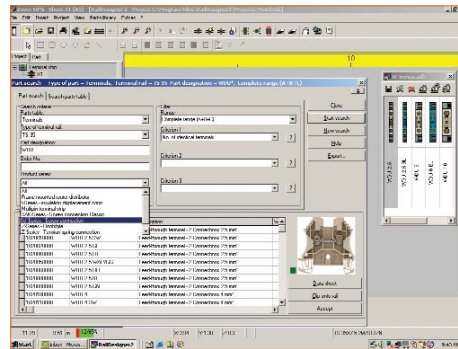

1. First Select

- Over 5,000 parts to select from
- Print out data sheet of selected parts

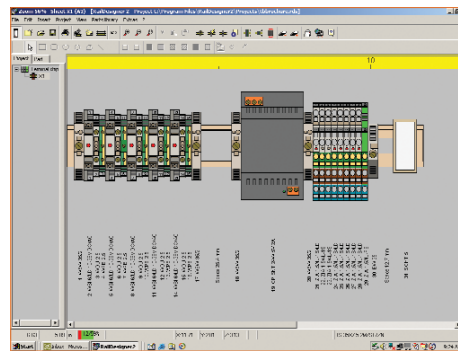

2. Then Build

- Assign products to the rail
- Jumper
- Insert customer specific components (i.e. contactors, interface boards, etc.)

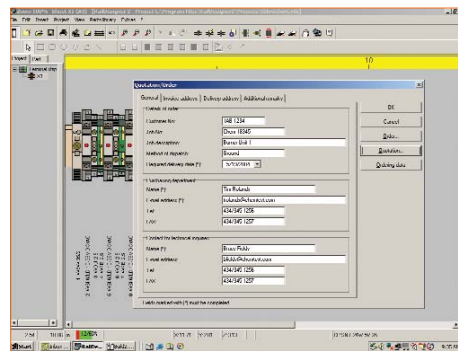

3. Now Order

- Contact local authorized Weidmüller distributor

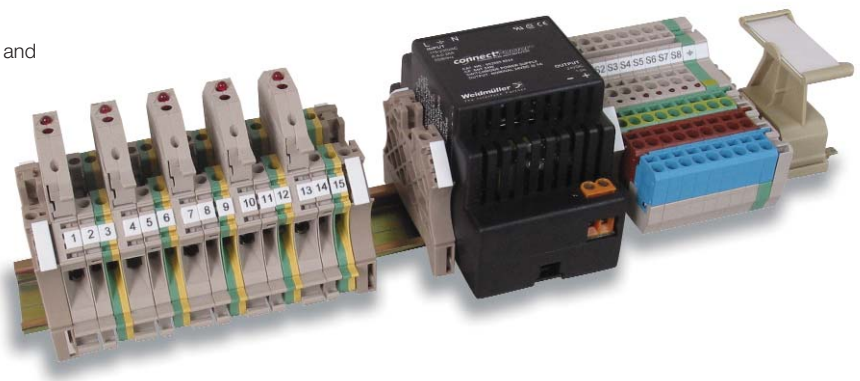



Industrial Ethernet

Industrial Ethernet

Unmanaged Switches	G.2
Media Converters	G.3
Managed Switches	G.4
Routers	G.5
Connectivity	G.5

Industrial Ethernet - Unmanaged Switches

Unmanaged Switches	
	
Number of Ports	5x RJ45
Data Rate	10 / 100 Mbps
Segment Length	100m
Input Voltage	10-36Vdc / 8-24Vac
Input Power	5 watts dc, 5VA ac
Operating Temp	0°C - +60°C
Dimensions (LxWxH)	116 x 25.4 x 70mm
Part Number	8808230000
Type	IE-SW5-ECO
Approvals	cULus, CE
Features	Auto MDIX Auto Negociation
	
Number of Ports	5 x RJ45
Data Rate	10 / 100 Mbps
Segment Length	100m
Input Voltage	10-36Vdc / 8-24Vac
Input Power	5 watts dc, 5VA ac
Operating Temp	0°C - +60°C
Dimensions (LxWxH)	100 x 90 x 24.6mm
Part Number	8833790000
Type	IE-SW5-ECO-FLAT
Approvals	cULus, CE
Features	Auto MDIX Auto Negociation
	
Number of Ports	8 x RJ45
Data Rate	10 / 100 Mbps
Segment Length	100m
Input Voltage	10-36Vdc / 8-24Vac
Input Power	5 watts dc, 5VA ac
Operating Temp	0°C - +60°C
Dimensions (LxWxH)	116 x 44.1 x 98mm
Part Number	8829430000
Type	IE-SW8-ECO
Approvals	cULus, CE
Features	Auto MDIX Auto Negociation Redundant Power Supply
	
Number of Ports	8 x RJ45
Data Rate	10 / 100 Mbps
Segment Length	100m
Input Voltage	10-36Vdc / 8-24Vac
Input Power	6 watts dc, 6VA ac
Operating Temp	0°C - +60°C
Dimensions (LxWxH)	156 x 44 x 164.5mm
Part Number	8808240000
Type	IE-SW8
Approvals	cULus, CE
Features	4K Mac addresses Auto Negociation Redundant Power Supply
	
Number of Ports	4 x RJ45, 2 SC
Data Rate	10 / 100 Mbps
Segment Length	100m RJ45, 2km Fibre
Input Voltage	10-36Vdc / 8-24Vac
Input Power	6 watts dc, 6VA ac
Operating Temp	0°C - +60°C
Dimensions (LxWxH)	156 x 44 x 164.5mm
Part Number	8808250000
Type	IE-SW4/2SC
Approvals	cULus, CE
Features	4K Mac addresses Auto Negociation Redundant Power Supply

Unmanaged Switches	
	
Number of Ports	24 x RJ45
Data Rate	10 / 100 Mbps
Segment Length	100m
Input Voltage	10-36Vdc / 8-24Vac
Input Power	20 watts dc, 20VA ac
Operating Temp	-40°C - +75°C
Dimensions (LxWxH)	140 x 44 x 156mm
Part Number	8808300000
Type	IE-SW24
Approvals	cULus, CE
Features	4K Mac addresses / 8 ports Auto Negociation, Auto MDIX Redundant Power Supply Status Relay
	
Number of Ports	22 x RJ45, 2 SC
Data Rate	10 / 100 Mbps
Segment Length	100m RJ45, 2km Fibre
Input Voltage	10-36Vdc / 8-24Vac
Input Power	20 watts dc, 20VA ac
Operating Temp	-40°C - +75°C
Dimensions (LxWxH)	140 x 44 x 156mm
Part Number	8808310000
Type	IE-SW22/2SC
Approvals	cULus, CE
Features	4K Mac addresses / 8 ports Auto Negociation, Auto MDIX Redundant Power Supply Status Relay
	
Number of Ports	22 x RJ45, 2 ST
Data Rate	10 / 100 Mbps
Segment Length	100m RJ45, 2km Fibre
Input Voltage	10-36Vdc / 8-24Vac
Input Power	20 watts dc, 20VA ac
Operating Temp	-40°C - +75°C
Dimensions (LxWxH)	140 x 44 x 156mm
Part Number	8808320000
Type	IE-SW22/2ST
Approvals	cULus, CE
Features	4K Mac addresses / 8 ports Auto Negociation, Auto MDIX Redundant Power Supply Status Relay

Industrial Ethernet - Unmanged Switches & Media Converters

Unmanaged Switches



4 x RJ45, 2 ST	16 x RJ45	14 x RJ45, 2 SC	14 x RJ45, 2 ST		
10 / 100 Mbps	10 / 100 Mbps	10 / 100 Mbps	10 / 100 Mbps		
100m RJ45, 2km Fibre	100m	100m RJ45, 2km Fibre	100m RJ45, 2km Fibre		
10-36Vdc / 8-24Vac	10-36Vdc / 8-24Vac	10-36Vdc / 8-24Vac	10-36Vdc / 8-24Vac		
6 watts dc, 6VA ac	20 watts dc, 20VA ac	20 watts dc, 20VA ac	20 watts dc, 20VA ac		
0°C - +60°C	-40°C - +75°C	-40°C - +75°C	-40°C - +75°C		
156 x 44 x 164.5mm	156 x 44 x 164.5mm	156 x 44 x 164.5mm	156 x 44 x 164.5mm		
8808260000	8808270000	8808280000	8808290000		
IE-SW4/2ST	IE-SW16	IE-SW14/2SC	IE-SW14/2ST		
cULus, CE	cULus, CE	cULus, CE	cULus, CE		
4K Mac addresses Auto Negociation Redundant Power Supply	4K Mac addresses / 8 ports Auto Negociation, Auto MDIX Redundant Power Supply Status Relay	4K Mac addresses / 8 ports Auto Negociation, Auto MDIX Redundant Power Supply Status Relay	4K Mac addresses / 8 ports Auto Negociation, Auto MDIX Redundant Power Supply Status Relay		

Media Converters



Number of Ports	2 x RJ45, 1 x SC	2 x RJ45, 1 x ST			
Data Rate	10 / 100 Mbps	10 / 100 Mbps			
Segment Length	100m RJ45, 2 km Fibre	100m RJ45, 2 km Fibre			
Input Voltage	10-36Vdc / 8-24Vac	10-36Vdc / 8-24Vac			
Input Power	4 watts dc, 4VA ac	4 watts dc, 4VA ac			
Operating Temp	0°C - +60°C	0°C - +60°C			
Dimensions (LxWxH)	79 x 40 x 85mm	79 x 40 x 85mm			
Part Number	8808220000	8808190000			
Type	IE-MC-SC	IE-MC-ST			
Approvals	cULus, CE	cULus, CE			
Features	MDI and MDIX RJ45 Inputs Auto Negotiation Redundant power supply inputs Invisible to other network components Full / Half duplex configurable	MDI and MDIX RJ45 Inputs Auto Negotiation Redundant power supply inputs Invisible to other network components Full / Half duplex configurable			



Industrial Ethernet - Managed Switches

Managed Switches						
Number of Ports		8x RJ45	6 x RJ45, 2 x SC	6 x RJ45, 2 x ST	16 x RJ45	14 x RJ45, 2 SC
Data Rate		10 / 100 Mbps	10 / 100 Mbps	10 / 100 Mbps	10 / 100 Mbps	10 / 100 Mbps
Segment Length		100m	100m RJ45, 2 km Fibre	100m RJ45, 2 km Fibre	100m	100m RJ45, 2km Fibre
Input Voltage		10-36Vdc / 8-24Vac	10-36Vdc / 8-24Vac	10-36Vdc / 8-24Vac	10-36Vdc / 8-24Vac	10-36Vdc / 8-24Vac
Input Power		20 watts dc, 20VA ac	20 watts dc, 20VA ac	20 watts dc, 20VA ac	20 watts dc, 20VA ac	20 watts dc, 20VA ac
Operating Temp		-40°C - +75°C	-40°C - +75°C	-40°C - +75°C	-40°C - +75°C	-40°C - +75°C
Dimensions (LxWxH)		156 x 44 x 164.5mm	156 x 44 x 164.5mm	156 x 44 x 164.5mm	156 x 44 x 164.5mm	156 x 44 x 164.5mm
Part Number		8845740000	8845840000	8845850000	8845800000	8845780000
Type		IE-SW8-M	IE-SW6/2SC-M	IE-SW6/2ST-M	IE-SW16-M	IE-SW14/2SC-M
Approvals		cULus, CE	cULus, CE	cULus, CE	cULus, CE	cULus, CE
Features		SNMP V1, Rapid Ring, IGMP Snooping Port Mirroring, Port Filtering, Trunking, VLAN, QoS, TOS 4K Mac addresses per 8 ports Auto MDIX, Auto Negotiation	SNMP V1, Rapid Ring, IGMP Snooping Port Mirroring, Port Filtering, Trunking, VLAN, QoS, TOS 4K Mac addresses per 8 ports Auto MDIX, Auto Negotiation	SNMP V1, Rapid Ring, IGMP Snooping Port Mirroring, Port Filtering, Trunking, VLAN, QoS, TOS 4K Mac addresses per 8 ports Auto MDIX, Auto Negotiation	SNMP V1, Rapid Ring, IGMP Snooping Port Mirroring, Port Filtering, Trunking, VLAN, QoS, TOS 4K Mac addresses per 8 ports Auto MDIX, Auto Negotiation	SNMP V1, Rapid Ring, IGMP Snooping Port Mirroring, Port Filtering, Trunking, VLAN, QoS, TOS 4K Mac addresses per 8 ports Auto MDIX, Auto Negotiation







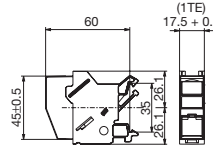

Managed Switches					
Number of Ports		14 x RJ45, 2 ST	24 x RJ45	22 x RJ45, 2 SC	22 x RJ45, 2 ST
Data Rate		10 / 100 Mbps	10 / 100 Mbps	10 / 100 Mbps	10 / 100 Mbps
Segment Length		100m RJ45, 2km Fibre	100m	100m RJ45, 2km Fibre	100m RJ45, 2km Fibre
Input Voltage		10-36Vdc / 8-24Vac	10-36Vdc / 8-24Vac	10-36Vdc / 8-24Vac	10-36Vdc / 8-24Vac
Input Power		20 watts dc, 20VA ac	20 watts dc, 20VA ac	20 watts dc, 20VA ac	20 watts dc, 20VA ac
Operating Temp		-40°C - +75°C	-40°C - +75°C	-40°C - +75°C	-40°C - +75°C
Dimensions (LxWxH)		156 x 44 x 164.5mm	156 x 44 x 164.5mm	156 x 44 x 164.5mm	156 x 44 x 164.5mm
Part Number		8845790000	8845830000	8845810000	8845820000
Type		IE-SW14/2ST-M	IE-SW24-M	IE-SW22/2SC-M	IE-SW22/2ST-M
Approvals		cULus, CE	cULus, CE	cULus, CE	cULus, CE
Features		SNMP V1, Rapid Ring, IGMP Snooping Port Mirroring, Port Filtering, Trunking, VLAN, QoS, TOS 4K Mac addresses per 8 ports Auto MDIX, Auto Negotiation	SNMP V1, Rapid Ring, IGMP Snooping Port Mirroring, Port Filtering, Trunking, VLAN, QoS, TOS 4K Mac addresses per 8 ports Auto MDIX, Auto Negotiation	SNMP V1, Rapid Ring, IGMP Snooping Port Mirroring, Port Filtering, Trunking, VLAN, QoS, TOS 4K Mac addresses per 8 ports Auto MDIX, Auto Negotiation	SNMP V1, Rapid Ring, IGMP Snooping Port Mirroring, Port Filtering, Trunking, VLAN, QoS, TOS 4K Mac addresses per 8 ports Auto MDIX, Auto Negotiation





Industrial Ethernet - Routers & Connectivity

Routers					
					
Number of Ports	2 x RJ45, 1 x RS232	1 x RJ45, 2 x RS232	1 x RJ45 Ethernet, 1 x RJ45 Modem, 2 x RS-232	1 x RJ45 Ethernet, 1 x RJ45 ISDN, 2 x RS-232	
Data Rate	10 / 100 Mbps	10 / 100 Mbps	10 / 100 Mbps	10 / 100 Mbps	
Segment Length	100m	100m	100m	100m	
Input Voltage	10-36Vdc / 8-24Vac	10-36Vdc / 8-24Vac	10-36Vdc / 8-24Vac	10-36Vdc / 8-24Vac	
Input Power	4 watts dc, 4VA ac	4 watts dc, 4VA ac	6 watts dc, 6VA ac	6 watts dc, 6VA ac	
Operating Temp	0°C - +60°C	0°C - +60°C	0°C - +60°C	0°C - +60°C	
Dimensions (LxWxH)	79 x 40 x 85mm	79 x 40 x 85mm	156 x 44 x 164.5mm	156 x 44 x 164.5mm	
Part Number	8845760000	8845770000	8845860000	8845750000	
Type	IE-ARM-E	IE-ARM-U	IE-AR-10T	IE-AR-10T-ISDN	
Approvals	cULus, CE	cULus, CE	cULus, CE	cULus, CE	
Features	Configurable Firewall Port forwarding, DND/DynDNS Dial on Demand, Call back Webserver / console programmable RS-232 for Console or ext. modem	Configurable Firewall Port forwarding, DND/DynDNS Dial on Demand, Call back Webserver / console programmable RS-232 for Console or ext. modem	Analog Modem, Firewall Port forwarding, DND/DynDNS Dial on Demand, Call back Webserver / console programmable RS-232 for Console or ext. modem	ISDN Modem, Firewall Port forwarding, DND/DynDNS Dial on Demand, Call back Webserver / console programmable RS-232 for Console or ext. modem	

Connectivity					
					
Mechanical					
Description	Terminal block for RJ45 with IDC on the back end	Terminal block for ST fibre optic cables	Terminal block for RJ45 with RJ45 on the back end		
Category Rating	Cat. 6e		Cat. 6e		
IRating	IP 20	IP 20	IP 20		
Front Connector	RJ45 Female	ST	RJ45 Female		
Back Connector	IDC	ST	RJ45 Female		
Standard Pack	1	1	1		
Part Number	8808360000	8808340000	8879050000		
Type	IE-XM-RJ45/IDC	IE-XM-ST/ST	IE-XM-RJ45/RJ45		

Industrial Ethernet - Connectivity

Connectivity					
Mechanical					
Description	IP 67 screw down Ethernet cable coupler	IP 67 Ethernet cable coupler	IP67 mating plug	Adapter for putting 2 ethernet networks on one 4 pair cable. Comes in pairs of 2.	
Category Rating	Cat. 6e	Cat. 6e	Cat. 6e	Cat. 5e	
IIP Rating	IP 67	IP 67	IP67	IP20	
Front Connector	RJ45 Female	RJ45 Female	RJ45 Male	1 x RJ45 Male	
Back Connector	IDC	IDC	IDC	2 x RJ45 female	
Standard Pack	1	1	1	2	
Part Number	8808370000	8813090000	8808380000	8808400000	
Type	IE-S-IP67	IE-C-IP67	IE-P-IP67	IE-CSM 1 Set	
Mechanical					
Description	Chasis mount flange with RJ45 insert (RJ45 to IDC)	Chasis mount flange with RJ45 insert (RJ45 to RJ45)	Chasis mount flange with RJ45 insert (90° downward RJ45 to RJ45)	Chasis mount flange with RJ45 insert (90° upward RJ45 to RJ45)	Ethernet IDC connection box used for extending or repairing Ethernet cables
Category Rating	Cat. 6e	Cat. 5e	Cat. 5e	Cat. 5e	Cat. 7
IIP Rating	IP67	IP67	IP67	IP67	IP 20
Front Connector	RJ45 Female	RJ45 Female	RJ45 Female	RJ45 Female	IDC
Back Connector	IDC	RJ45 Female	RJ45 Female	RJ45 Female	IDC
Standard Pack	1	1	1	1	1
Part Number	8808440000	8808450000	8829450000	8829440000	8808410000
Type	IE-XM-RJ45/IDC-IP67	IE-XM-RJ45/RJ45-IP67	IE-XM-6D-RJ45/RJ45-IP67	IE-XM-6U-RJ45/RJ45-IP67	IE-CCM

Accessories					
					
Functionality	Device for testing ethernet cables for: crossed wires, short cuts, line & core interruptions etc.	Punch down tool for ethernet cables AWG20 - AWG28 (0.08-0.34mm ²)	Crimping tool for 8-pole shielded RJ45 plugs AWG27 - AWG24 (0.09-0.20mm ²)	Sheathing stripper for shielded data lines AWG20 - AWG11 (0.5 - 3.9mm ²)	
Supply	9V battery				
Dimensions (LxWxH)	70x140x36mm (basic) 30x68x23mm (test box)				
Part Number	8808420000	9013970000	9202800000	9030060000	
Type	IE-CT	PDT	TT 8RJ MP8	AM12	
Features/Accessories	9V battery included	PD blade (standard) 9014000000 PD blade (scissors) 9014050000			

Patch Cables and Fiber Optics

True to the idea of "one-stop shopping", Weidmüller can also supply Ethernet copper as well as fibre optic connecting cables.

- Copper cables available in Cat 5, Cat 5e, Cat 6, Cat7 1:1 versions or crossover.
- Patch cables have a molded RJ45 plug that provides kink protection and provides good strain relief.
- Extended temp range pur: -40°C to +70°C

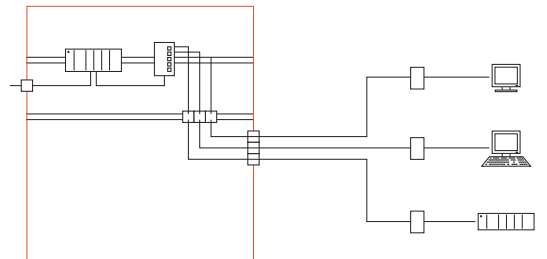

- All the FO cables from Weidmüller can be supplied with SC duplex or ST connectors.
- Available as PVC zip-cord
- Resistant to oils, acids, electrolytes

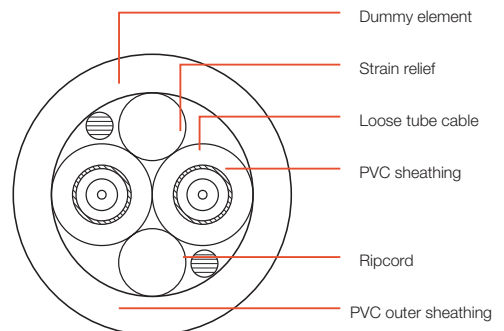

FO breakout cable

* Contact Weidmüller for more detailed information and part numbers.

Notes

Index

Index	Index by Description	X.2
	Index by Part Number	X.8

Appendix

Index
Search according to description or part number

Description	Part Number	Page
A		
AC OUTLET EUROPEAN FOR TS35	8734580000	D.4
ADAPTOR FOOT	9102100000	B.5
ADAPTOR PG 11/NPT 3/8	1712340000	C.3
ADAPTOR PG13.5 - NPT 1/2	1712350000	C.3
ADAPTOR PG36 - NPT 1 1/4	1712380000	C.3
AEH 0.75/18	9025910000	E.8
AEH 1.0/16 FERRULES (YELLOW)	9025950000	E.8
AEH 1.0/18 FERRULES	9025930000	E.8
AM 1/25/35 REPLACEMENT BLADE	9001530000	E.2
AM 12 GRAY	9030060000	E.2
AM 12 GRAY	9030060000	G.7
AM 25 STRIP TOOL	9001540000	E.2
AM 35 STRIPPING TOOL	9001080000	E.2
ANALOG ISOLATOR W/BIPOLAR VOLT	G408-1000	D.19
ANALOG ISOLATOR W/BIPOLAR VOLT	G408-1000	D.21
AP DK5 END PLATE	C9039986	D.6
AP DK5 END PLATE	C9039986	D.10
AP DK5 END PLATE	C9039986	D.18
AP DK6 END PLATE	C9040396	D.18
AP FOR DKT 4,PA,BG	0687560000	D.10
AP FOR DKT 4,PA,BG	0687560000	D.6
AP FOR MCZ PRODUCTS	8389030000	D.6
AP FOR MCZ PRODUCTS	8389030000	D.12
AP FOR MCZ PRODUCTS	8389030000	D.20
ASK 1 EN, NO LED, PA, BG	0474560000	A.8
ASK1EN/SMT10-60VUC BFI H-	0222760001	A.8
ASK1EN/SMT10-60VUC BFI H+	9123140001	A.8
ASK1EN/SMT100-250VUC BFI H-	0225560001	A.8
ASK1EN/SMT100-250VUC BFI H+	9118290001	A.8
B		
BLADE SET NEW STRIPAX 6	9054030000	E.2
BLUE STRIP FERRULES	9004360000	E.8
BLUE TWIN FERRULES	9004430000	E.11
BRUSH FOR STRIPAX	9005450000	E.2
BS M5X8 HEX F.TST/TSTW,ST	0295900000	A.17
BS M6X12 HEX F.TST/TSTW,ST	0353500000	A.17
BS M6X8 HEX F.TST/TSTW,ST	0642600000	A.17
C		
CB 80VDC, 10A, CURVE U2, 1P	9926251910	B.2
CB 80VDC, 15A, CURVE U2, 1P	9926251915	B.2
CB 80VDC, 1A, CURVE U2, 1P	9926251901	B.2
CB 80VDC, 20A, CURVE U2, 1P	9926251920	B.2
CB 80VDC, 2A, CURVE U2, 1P	9926251902	B.2
CB 120V, 1A, CURVE KM, 1 POLE	9926251001	B.2
CB 120V, 2A, CURVE KM, 1 POLE	9926251002	B.2
CB 120V, 5A, CURVE KM, 1 POLE	9926251005	B.2
CB 120V,10A, CURVE KM, 1 POLE	9926251010	B.2
CB 120V,15A, CURVE KM, 1 POLE	9926251015	B.2
CB 120V,20A, CURVE KM, 1 POLE	9926251020	B.2
CB 120V,25A, CURVE KM, 1 POLE	9926251025	B.2
CB 240V, 1A, CURVE KM, 2 POLE	9926252001	B.2
CB 240V, 2A, CURVE KM, 2 POLE	9926252002	B.2
CB 240V, 5A, CURVE KM, 2 POLE	9926252005	B.2
CB 240V,10A, CURVE KM, 2 POLE	9926252010	B.2
CB 240V,15A, CURVE KM, 2 POLE	9926252015	B.2
CB 240V,20A, CURVE KM, 2 POLE	9926252020	B.2
CB 240V,25A, CURVE KM, 2 POLE	9926252025	B.2
CC 15/17 K MC NEUTRAL SILVER	1876580000	F.26
CC 15/17 K MC NEUTRAL WHITE	1876590000	F.26
CC 15/17 MC NEUTRAL SILVER	1876610000	F.24
CC 15/17 MC NEUTRAL WHITE	1876570000	F.24
CC 15/27 K MC NEUTRAL SILVER	1876780000	F.26
CC 15/27 K MC NEUTRAL WHITE	1876640000	F.26
CC 15/27 MC NEUTRAL SILVER	1876760000	F.24
CC 15/27 MC NEUTRAL WHITE	1876770000	F.24
CC 15/49 K MC NEUTRAL SILVER	1877220000	F.26
CC 15/49 K MC NEUTRAL WHITE	1877220000	F.26
CC 15/49 MC NEUTRAL SILVER	1877240000	F.24
CC 15/49 MC NEUTRAL WHITE	1877260000	F.24
CC 15/60 K MC NEUTRAL SILVER	1877360000	F.26
CC 15/60 K MC NEUTRAL WHITE	1877310000	F.26
CC 15/60 MC NEUTRAL SILVER	1877340000	F.26
CC 15/60 MC NEUTRAL WHITE	1877350000	F.26
CC 30/60 K MC NEUTRAL SI	1934330000	F.26
CC 30/60 K MC NEUTRAL WS	1934390000	F.26
CC 30/60 MC NEUTRAL SI	1934400000	F.26
CC 30/60 MC NEUTRAL WS	1934420000	F.26
CC-H 15/17 BLACK HOLDER	1790430000	F.26
CC-H 15/27 BLACK HOLDER	1790410000	F.26
CC-H 15/49 BLACK HOLDER	1790420000	F.26
CC-H 15/60 BLACK HOLDER	1878910000	F.26
CC-H 30/60	1934430000	F.26
CC-RAIL 1000 BLACK CARRIER	1790150000	F.26
CC-RAIL 1000 TRANSPARENT COVER	1790160000	F.26
CIRCUIT BREAKER 1P .1A	9911010000	B.4
CIRCUIT BREAKER 1P .2A	9911020000	B.4
CIRCUIT BREAKER 1P .3A	9911030000	B.4
CIRCUIT BREAKER 1P .4A	9911040000	B.4
CIRCUIT BREAKER 1P .5A	9911050000	B.4
CIRCUIT BREAKER 1P .6A	9911060000	B.4
CIRCUIT BREAKER 1P .8A	9911080000	B.4
CIRCUIT BREAKER 1P 1.0A	9911100000	B.4
CIRCUIT BREAKER 1P 1.5A	9911150000	B.4
CIRCUIT BREAKER 1P 2.0A	9911200000	B.4
CIRCUIT BREAKER 1P 2.5A	9911250000	B.4
CIRCUIT BREAKER 1P 3.0A	9911300000	B.4
CIRCUIT BREAKER 1P 3.2A	9911320000	B.4
CIRCUIT BREAKER 1P 4.0A	9911400000	B.4
CIRCUIT BREAKER 1P 5.0A	9911500000	B.4
CIRCUIT BREAKER 1P 6.0A	9911600000	B.4
CIRCUIT BREAKER 1P 8.0A	9911800000	B.4
CIRCUIT BREAKER 2P .1A	9912010000	B.4
CIRCUIT BREAKER 2P .2A	9912020000	B.4
CIRCUIT BREAKER 2P .3A	9912030000	B.4
CIRCUIT BREAKER 2P .4A	9912040000	B.4
CIRCUIT BREAKER 2P .5A	9912050000	B.4
CIRCUIT BREAKER 2P .6A	9912060000	B.4
CIRCUIT BREAKER 2P .8A	9912080000	B.4
CIRCUIT BREAKER 2P 1.0A	9912100000	B.4
CIRCUIT BREAKER 2P 1.5A	9912150000	B.4
CIRCUIT BREAKER 2P 10A	9922100000	B.4
CIRCUIT BREAKER 2P 12A	9922120000	B.4
CIRCUIT BREAKER 2P 15A	9922150000	B.4
CIRCUIT BREAKER 2P 16A	9922160000	B.4
CIRCUIT BREAKER 2P 18A	9922180000	B.4
CIRCUIT BREAKER 2P 2.0A	9912200000	B.4
CIRCUIT BREAKER 2P 2.5A	9912250000	B.4
CIRCUIT BREAKER 2P 20A	9922200000	B.4
CIRCUIT BREAKER 2P 25A	9922250000	B.4
CIRCUIT BREAKER 2P 3.0A	9912300000	B.4
CIRCUIT BREAKER 2P 32A	9922320000	B.4
CIRCUIT BREAKER 2P 4.0A	9912400000	B.4
CIRCUIT BREAKER 2P 5.0A	9912500000	B.4
CIRCUIT BREAKER 2P 6.0A	9912600000	B.4
CIRCUIT BREAKER 2P 8.0A	9912800000	B.4
CIRCUIT BREAKER 3P .1A	9913010000	B.4
CIRCUIT BREAKER 3P .2A	9913020000	B.4
CIRCUIT BREAKER 3P .3A	9913030000	B.4
CIRCUIT BREAKER 3P .4A	9913040000	B.4
CIRCUIT BREAKER 3P .5A	9913050000	B.4
CIRCUIT BREAKER 3P .6A	9913060000	B.4
CIRCUIT BREAKER 3P .8A	9913080000	B.4
CIRCUIT BREAKER 3P 1.0A	9913100000	B.4
CIRCUIT BREAKER 3P 1.5A	9913150000	B.4
CIRCUIT BREAKER 3P 10A	9923100000	B.4
CIRCUIT BREAKER 3P 12A	9923120000	B.4
CIRCUIT BREAKER 3P 15A	9923150000	B.4
CIRCUIT BREAKER 3P 16A	9923160000	B.4
CIRCUIT BREAKER 3P 18A	9923180000	B.4
CIRCUIT BREAKER 3P 2.0A	9913200000	B.4
CIRCUIT BREAKER 3P 2.5A	9913250000	B.4
CIRCUIT BREAKER 3P 20A	9923200000	B.4
CIRCUIT BREAKER 3P 25A	9923250000	B.4
CIRCUIT BREAKER 3P 3.0A	9913300000	B.4
CIRCUIT BREAKER 3P 32A	9923320000	B.4
CIRCUIT BREAKER 3P 4.0A	9913400000	B.4
CIRCUIT BREAKER 3P 5.0A	9913500000	B.4
CIRCUIT BREAKER 3P 6.0A	9913600000	B.4
CIRCUIT BREAKER 3P 8.0A	9913800000	B.4
CP DM 20A DIODE MODULE	8768650000	D.29
CP-BBU 12VDC	9916280012	D.29
CP-BBU 24VDC	9916280024	D.29
CP-DCDC 12VDC IN/ 5VDC, 8A OUT	9919371205	D.28
CP-DCDC 12VDC IN/12VDC, 3A OUT	9919371212	D.28
CP-DCDC 12VDC IN/15VDC, 2A OUT	9919371215	D.28
CP-DCDC 12VDC IN/24VDC, 3A OUT	9919371224	D.28
CP-DCDC 24VDC IN/ 5VDC, 8A OUT	9919372405	D.28
CP-DCDC 24VDC IN/12VDC, 3A OUT	9919372412	D.28
CP-DCDC 24VDC IN/15VDC, 3A OUT	9919372415	D.28
CP-DCDC 24VDC IN/24VDC, 2A OUT	9919372424	D.28
CP-SNT 115,230VAC/ 5V2A	9928890005	D.26
CP-SNT 115,230VAC/12-15VDC 3A	9927480012	D.26
CP-SNT 115,230VAC/12V,1.5A	9928890012	D.26
CP-SNT 115,230VAC/15V,1.5A	9928890015	D.26
CP-SNT 115,230VAC/24-28V,2.3A	9927480024	D.26
CP-SNT 115,230VAC/24V,1.0A	9928890024	D.26
CP-SNT 115,230VAC/28V,1.0A	9928890028	D.26
CP-SNT 115,230VAC/48VDC,1.0A	9927480048	D.26
CP-SNT 115,230VAC/5VDC, 3A	9927480005	D.26
CP-SNT 120V 24V 5A	8708670000	D.27
CP-SNT 240V 24V 10A	8708680000	D.27
CP-SNT 360-480V 3PH/24VDC,2.3A	9917790324	D.26
CP-SNT 360-500V 3PH/24VDC,12.5	7924740324	D.26
CP-SNT 360-500V 3PH/24VDC,6.5A	9925340324	D.26
CP-SNT 380-480V 3PH/24VDC,25A	7920210324	D.26
CP-SNT 380-480V 3PH/24VDC,40A	7918960324	D.26
CP-SNT 70W 24V 3A	8708660000	D.27
CP-SNT DM 10 PARALLEL	8710620000	D.29
CP-SNT ECO 500W 24V 20A	8778870000	D.27
CP-SNT120W 115,230VAC/12V,10A	9925340012	D.26
CP-SNT12W 115,230VAC/24V,0.5A	9918840024	D.26
CP-SNT156W 115,230VAC/48V,3.25A	9925340048	D.26
CP-SNT160W 115,230V/24-28,6.5A	9925340024	D.26
CP-SNT3 1000W 24V 40A 3 PHASE	8708700000	D.27
CP-SNT3 250W 24V 10A 3 PHASE	8708700000	D.27
CP-SNT3 500W 24V 20A 3 PHASE	8708710000	D.27
CP-SNT300W 115-230V/24VDC,12.5A	9916250024	D.26
CP-SNT50W 115,230VAC/ 5V,10A	9925340005	D.26
CSR CUR. SEN. RELAY RS45 HOUS	9916090000	D.25
CUTTING BLADE FOR STRIPAX PLUS	9050340000	E.3
D		
DC BRANCH CB 25A 1 POLE	9926251925	B.2
DC BRANCH CB 30A 1 POLE	9926251930	B.2
DC BRANCH CB 35A 1 POLE	9926251935	B.2
DC BRANCH CB 40A 1 POLE	9926251940	B.2
DC BRANCH CB 45A 1 POLE	9926251945	B.2
DC BRANCH CB 50A 1 POLE	9926251950	B.2
DC BRANCH CB 55A 1 POLE	9926251955	B.2
DC BRANCH CB 6A 1 POLE	9926251905	B.2
DC BRANCH CB 10A 1 POLE	9926251910	B.2
DC BRANCH CB 15A 1 POLE	9926251915	B.2
DC BRANCH CB 20A 1 POLE	9926251920	B.2
DC BRANCH CB 25A 1 POLE	9926251925	B.2
DC BRANCH CB 30A 1 POLE	9926251930	B.2
DC BRANCH CB 35A 1 POLE	9926251935	B.2
DC BRANCH CB 40A 1 POLE	9926251940	B.2
DC BRANCH CB 45A 1 POLE	9926251945	B.2
DC BRANCH CB 50A 1 POLE	9926251950	B.2
DC BRANCH CB 55A 1 POLE	9926251955	B.2
DC BRANCH CB 60A 1 POLE	9926251960	B.2
DC CURRENT SENSOR + AMP	9916450000	D.21
DECIPAK 0-100MV/4-20MA/24V 2W	7940005531	D.21
DECIPAK 0-10MV/4-20MA/24V 2W	7940005529	D.21
DECIPAK 0-10V/0-5V/24V 4W	7940005508	D.21
DECIPAK 0-10V/4-20MA/24V 2W	7940005528	D.21
DECIPAK 0-10V/4-20MA/24V 4W	7940005599	D.21
DECIPAK 0-1MA/4-20MA/24V 2W	7940005523	D.19
DECIPAK 0-20MA/0-20MA/24V 4W	7940005488	D.19
DECIPAK 0-20MA/4-20MA/24V 4W	7940005524	D.19
DECIPAK 0-20MA/4-20MA/24V 4W	7940005485	D.19
DECIPAK 4-20/4-20/LOOP POWERED	7940005521	D.19
DECIPAK 4-20MA/0-10V/240V 4W	7940005478	D.19
DECIPAK 4-20MA/0-20MA/24V 2W	7940005542	D.19
DECIPAK 4-20MA/0-5V/24V 4W	7940005482	D.19
DECIPAK 4-20MA/120V 4W	7940005571	D.19
DECIPAK 4-20MA/4-20MA/24V 2W	7940005522	D.19
DECIPAK 4-20MA/4-20MA/24V 4W	7940005473	D.19
DEK 5/3.5 MC NEUTRAL WHITE	1755270000	F.2
DEK 5/5 MC-10 BLANK WHITE	1609801044	F.2
DEK 5/5 MC-10 NEUT. VAR	1609800000	D.24
DEK 5/5 PLUS MC NEUTRAL	1854490000	F.2
DEK 5/6 MC NEUTRAL WHITE	1609820000	D.6
DEK 5/6 MC NEUTRAL WHITE	1609820000	D.10
DEK 5/6 MC NEUTRAL WHITE	1609820000	D.12
DEK 5/6 MC NEUTRAL WHITE	1609820000	D.18
DEK 5/6 MC NEUTRAL WHITE	1609820000	D.20
DEK 5/6 MC NEUTRAL WHITE	1609820000	D.28
DEK 5/6 MC V0 NEUTRAL	1789590000	F.2
DEK 5/6.5 MC NEUTRAL WHITE	16	

Description	Part Number	Page
DKT 4/32,PA,BG	0687360000	A.10
DKT 4/35,PA,BG	0687460000	A.10
DMS MANUAL 0.5-1.7NM TORQUE	9918370000	E.7
DMS MANUAL 2.0-8.0NM TORQUE	9918380000	E.7
DMSI MANUAL 0.5-1.7NM TORQUE	9918390000	E.6
DMSI MANUAL 2.0-8.0NM TORQUE	9918400000	E.6

E

EK 10/32, PA,GN/YL	0354660000	A.8
EK 10/35,PA,GN/YL	0661360000	A.8
EK 16/32,PA,GN/YL	0374660000	A.8
EK 16/35,PA,GN/YL	0190160000	A.8
EK 2.5 N/32,PA,GN/YL	0474360000	A.8
EK 2.5/35,PA,GN/YL	0661060000	A.8
EK 35/32,PA,GN/YL	0354760000	A.8
EK 35/35,PA,GN/YL	0661460000	A.8
EK 4/32,PA,GN/YL	0354560000	A.8
EK 4/35,PA,GN/YL	0661160000	A.8
EK 6/35,PA,GN/YL	0661260000	A.8
ESG 10/17 MC NEUTRAL	1856700000	F.22
ESG 5/10 MC NEUTRAL WS	1919940000	F.22
ESG 6/15 K MC NEUTR. GE	1880130000	F.22
ESG 6/15 K MC NEUTR. WS	1880100000	F.22
ESG 6/15 MC RIDERSERIES	1881280000	F.22
ESG 6/17 K MC NEUTR. GE	1880110000	F.22
ESG 6/17 K MC NEUTR. WS	1880120000	F.22
ESG 7/20	1736181044	F.20
ESG 7/20	1736181044	F.22
ESG 7/20 SIRIUS TUERKIS	1736181696	F.22
ESG 7/20 SIRIUS YELLOW	1736181687	F.22
ESG 8/10	1736190000	F.22
ESG 8/17 F/MTG BAR SCH5 NEUTR	1720610000	F.22
ESG 8/17 L MC NEUTRAL	1890470000	F.22
ESG 8/17 MULTICARD NEUTRAL	1674740000	F.22
ESG 8/17 SYS PRO M	1755340000	F.22
ESG 8/19 MULTICARD NEUTRAL	1652220000	F.22
ESG 9/10 MC NEUTRAL WS	1917910000	F.22
ESG 9/11K MC NEUTRAL	1857440000	F.22
ESG 9/17 K NEUTRAL/GE	1753500000	F.22
ESG 9/17 WHITE BLANK NO ADHES.	1724760000	F.20
ESG 9/17K UNIVERSAL MULTICARD	1747760000	F.22
ESG 9/20 L MC NEUTRAL	1890460000	F.22
ESG 9/20 MC NEUTRAL GE	1766160000	F.22
ESG 9/20 MC UNIVERSAL	1856720000	F.22
ESG 9/20 MULTICARD	1609940000	F.22
ESO 5 (POLYESTER WHITE)	1670370000	F.20
ESO 5 POLYESTER YELLOW A4	1670380000	F.20
ESO 5 YELLOW	1631350000	F.20
ESO 7 A4 PAPER YELLOW	1634780000	F.20
ESO 7 A4 PAPER, WHITE 240PCS.	1607720000	F.20
ESO 7 POLYESTER WHITE	1670390000	F.20
ESO 7 POLYESTER YELLOW A4	1670400000	F.20
ESO 8/20 GE	1919900000	F.20
ESO 8/20 WS	1919890000	F.20
ESO 8/20P GE	1919880000	F.20
ESO 8/20P WS	1919870000	F.20
ESO FGPR MARK CARRIER	0139000000	F.22
ESOS FOR SCHT5 (60 PER SHEET)	1607710000	A.17
ESOS FOR SCHT5 (60 PER SHEET)	1607710000	F.20
ESOS5 F. SCHT5S(140 PER SHEET)	1631920000	A.17
ETO CC 15/17 TRANSPARENT LABEL	1880850000	F.26
ETO CC 15/27 TRANSPARENT LABEL	1880810000	F.26
ETO CC 15/49 TRANSPARENT LABEL	1880830000	F.26
ETO CC 15/60 TRANSPARENT LABEL	1880840000	F.26
ETO CC 30/60 TRANSPARENT LABEL	1934440000	F.26
EW 35 FOR TS 35,PA,BG	0383560000	A.16
EW 35 FOR TS 35,PA,BG	0383560000	A.18
EWK 1 FOR TS 32 SLOT,PA,BG	0495160000	A.16
EWK 1 FOR TS 32 SLOT,PA,BG	0495160000	A.18
EWK 1 FOR TS 32,PA,BG	0206160000	A.16
EWK 1 FOR TS 32,PA,BG	0206160000	A.18
EWK 2 FOR TS 32,PA,BG	0199360000	A.16
EWK 2 FOR TS 32,PA,BG	0199360000	A.18

F

FM 4 MOUNTING FOOT FOR TS 35	0687900000	A.17
FM5 (M5)	0636800000	A.17
FM6 (M6) FOR TS 35	0636900000	A.17

G

GFI OUTLET, 15A,LPZF TERMINALS	7940000037	D.4
GFI OUTLET, 20A, LLP TERMINALS	7940000036	D.4

H

H 0.14/10 GREY STRIP PACK	9005180000	E.8
H 0.14/12 GREY STRIP PACK	9028240000	E.8
H 0.25/10 LIGHT BLUE	9025740000	E.8
H 0.25/10,24AWG,INS,LIGHT BLUE	9026050000	E.8
H 0.25/12 LIGHT BLUE FERRULES	9025760000	E.8
H 0.25/12 LIGHT BLUE STRIP PKG	9025780000	E.8
H 0.25/5 UNINSULATED FERRULES	9018910000	E.9
H 0.34/10 TURQUOISE FERRULES	9025750000	E.8
H 0.34/12 FERRULES STRIP PCK	9025790000	E.8
H 0.34/12 TURQUOISE FERRULES	9025770000	E.8
H 0.34/12 TURQUOISE ON REELS	9004390000	E.8
H 0.5/10 FERRULES	9004050000	E.9
H 0.5/10 ORANGE STRIP PKG	9028260000	E.8
H 0.5/12,20 AWG,INS, ORANGE	0409500000	E.8
H 0.5/14 ORANGE REEL FERRULES	9005810000	E.8

Description	Part Number	Page
H 0.5/14,20AWG,INS,ORANGE	0690700000	E.8
H 0.5/15 ORANGE TWIN FERRULES	9004440000	E.11
H 0.5/15 ZH ORANGE	9037200000	E.11
H 0.5/16 OR SV	9028270000	E.8
H 0.5/16 ORANGE FERRULES	9025870000	E.8
H 0.5/16 ORANGE FERRULES	9026060000	E.8
H 0.5/16.5 ZH ORANGE FERRULES	9037210000	E.11
H 0.5/18.5 ZH ORANGE TWIN	9037220000	E.11
H 0.5/6,26-22AWG,UNINSULATED	0282600000	E.9
H 0.75/10,20AWG,UNINSULATED	0542500000	E.9
H 0.75/12 WHITE STRIP PKG	9028280000	E.8
H 0.75/12,18AWG,INS,WHITE	0409600000	E.8
H 0.75/14 WHITE	9026070000	E.8
H 0.75/14 WHITE REEL FERRULES	9005820000	E.8
H 0.75/14,18AWG,INS,WHITE	0462900000	E.8
H 0.75/15 ZH WHITE TWIN FERR	9037230000	E.11
H 0.75/15 ZH WHITE TWIN FERRULE	9018510000	E.11
H 0.75/16 WHITE	9025860000	E.8
H 0.75/16 WHITE FERRULES	9028290000	E.8
H 0.75/17 WHITE STRIP PACKAGE	9004900000	E.11
H 0.75/17 ZH WHITE	9037240000	E.11
H 0.75/18 W SV	9028300000	E.8
H 0.75/24, 5 ZH WHITE FERRULES	9037250000	E.11
H 0.75/6,20AWG,UNINSULATED	0282700000	E.9
H 1/14 YELLOW	9026080000	E.8
H 1/15 S ZH YELLOW	9018690000	E.11
H 1.0/10,18AWG,UNINSULATED	0282800000	E.9
H 1.0/12 GE SV	9028310000	E.8
H 1.0/12,18AWG,INS,YELLOW	0409700000	E.8
H 1.0/14 YELLOW FERRULES	9004320000	E.8
H 1.0/14 YELLOW REEL FERRULES	9005830000	E.8
H 1.0/14,18AWG,INS,YELLOW	0463000000	E.8
H 1.0/15 ZH YELLOW FERRULES	9037260000	E.11
H 1.0/15S ZH GE SV	9018650000	E.11
H 1.0/16 YELLOW STRIP PCK	9028320000	E.8
H 1.0/18 GE SV	9028340000	E.8
H 1.0/20 ZH GE SV	9004910000	E.11
H 1.0/20 ZH YELLOW	9037270000	E.11
H 1.0/25.6 ZH YELLOW	9037280000	E.11
H 1.0/6,18AWG,UNINSULATED	0372600000	E.9
H 1.5/10,16AWG,UNINSULATED	0188500000	E.9
H 1.5/12 NON-INSULATED	9004060000	E.9
H 1.5/14	9026090000	E.8
H 1.5/14 RED REEL FERRULES	9005840000	E.8
H 1.5/14,16AWG,INS,RED	0463100000	E.8
H 1.5/16 RED FERRULES STRIP PK	9028350000	E.8
H 1.5/16 RED TWIN FERRULES	9004410000	E.11
H 1.5/16 ZH RED FERRULES	9037290000	E.11
H 1.5/16,16AWG,INS,RED	0635100000	E.8
H 1.5/18 NON-INSULATED FERRULE	9004070000	E.9
H 1.5/20 ZH R SV	9004920000	E.11
H 1.5/20 ZH RED FERRULES	9037300000	E.11
H 1.5/24,16AWG,INS,RED	0566500000	E.11
H 1.5/25 6 ZH RED FERRULES	9037310000	E.11
H 1.5/7,16AWG,UNINSULATED	0372700000	E.9
H 2.5 FERRULES 14	9026100000	E.8
H 2.5/10 FERRULES	9004080000	E.9
H 2.5/12,14AWG,UNINSULATED	0186100000	E.9
H 2.5/14D	9019160000	E.8
H 2.5/14D BLUE REEL FERRULES	9005850000	E.8
H 2.5/18 D BLUE FERRULES	9019170000	E.8
H 2.5/18 FERRULES	9004090000	E.9
H 2.5/18 SD ZH BLUE	9037500000	E.11
H 2.5/20.5 D ZH BLUE FERRULES	9004740000	E.11
H 2.5/20.5D ZH BLUE	9037510000	E.11
H 2.5/25,14AWG, INS, BLUE	9019180000	E.8
H 2.5/26, 5D ZH BLUE FERRULES	9037520000	E.11
H 2.5/7,14AWG,UNINSULATED	0373000000	E.9
H 4/0/25, 12AWG, INS, GREY	9019210000	E.8
H 4/15 FERRULES	9004100000	E.9
H 4/17 D GREY FERRULE	9019190000	E.8
H 4/17 D GREY FERRULES	9026010000	E.8
H 4/18 NON-INSULATED FERRULE	9004110000	E.9
H 4/20D GREY FERRULES	9019200000	E.8
H 4/22 D GREY	9004730000	E.11
H 4.0/12,12AWG,UNINSULATED	0244100000	E.9
H 4.0/22D ZH GREY	9037530000	E.11
H 4.0/26D ZH GREY FERRULES	9037540000	E.11
H 4.0/9,12AWG,UNINSULATED	0373100000	E.9
H 6/10 FERRULES	9004120000	E.9
H 6/18 FERRULES W/O COLLAR	9004130000	E.9
H 6.0/12,10AWG,UNINSULATED	0191900000	E.9
H 6.0/15,10AWG,UNINSULATED	0124700000	E.9
H 6.0/20,10AWG,INS,BLACK	0533500000	E.8
H 6.0/25 ZH BLACK FERRULES	9037320000	E.11
H 6.0/25 ZH BLACK SV FERRULES	9004930000	E.11
H 6.0/26,10AWG,INS,BLACK	0565700000	E.8
H 6.0/29 ZH BLACK FERRULES	9037330000	E.11
H 10/24 ZH IVORY STRIP PACK	9018860000	E.11
H 10/30S ZH EB	9018870000	E.11
H 10.0/12,8AWG,UNINSULATED	0282900000	E.9
H 10.0/15,8AWG,UNINSULATED	0124800000	E.9
H 10.0/18,8AWG,UNINSULATED	0379300000	E.8
H 10.0/21,8AWG,INS,IVORY	0534200000	E.9
H 10.0/26 ZH IVORY FERRULES	9037340000	E.11
H 10.0/26 ZH IVORY STRIP PACK	9004940000	E.11
H 10.0/27,8AWG,INS,IVORY	0565800000	E.8
H 10.0/30 ZH EB	9037350000	E.11
H 16/18 6 AWG UNINSULATED	0375200000	E.9
H 16/25 FERRULE	9004150000	E.9
H 16.0/12,6AWG,UNINSULATED	0492500000	E.9
H 16.0/15,6AWG,UNINSULATED	0124300000	E.8
H 16.0/22,6AWG,INS,GREEN	0565900000	E.9
H 16.0/28,6AWG,INS,GREEN	0566000000	E.8
H 16.0/29 TWIN GREEN FERRULE	9037360000	E.11
H 16.0/32	9004160000	E.9
H 25/25 3 AWG UNINSULATED	9004170000	E.9

Description	Part Number	Page
H 25.0/15,4AWG,UNINSULATED	0124400000	E.9
H 25.0/18,2AWG,UNINSULATED	0375300000	E.9
H 25.0/29,4AWG,INS,BROWN	0317000000	E.8
HDC-KIT HA 03.300M	1802470000	C.2
HDC-KIT HA 04.402 M	1802700000	C.2
H 25.0/32	9004180000	E.9
H 25.0/35,4AWG,INS,BROWN	0317100000	E.8
H 35/32 2 AWG UNINSULATED	9004190000	E.9
H 35/32 2 AWG UNINSULATED	9004200000	E.9
H 35.0/18,2AWG,UNINSULATED	0368900000	E.9
H 35.0/30,2AWG,INS,BEIGE	0317200000	E.8
H 35.0/30S	9451000000	E.9
H 35.0/39,2AWG,INS,BEIGE	0317300000	E.8
H 50/18 FERRULES	9004210000	E.9
H 50/32 FERRULES W/O COLLAR	9004220000	E.9
H 50.0 FERRULES	9025880000	E.9
H 50.0/37, 1/0 AWG INS. OLIVE	0444200000	E.8
H 70/25 FERRULES	9004230000	E.9
H 70/32 FERRULES	9004240000	E.9
H 70.0/40 YELLOW	9028200000	E.8
H 95/25 FERRULES	9004250000	E.9
H 95/32 FERRULE W/O COLLAR	9004260000	E.9
H 95/44 RED FERRULES 3/0 AWG	9028210000	E.8
H 120/32 FERRULES W/O COLLARS	9036240000	E.9
H 120/50 BLUE	9028220000	E.8
H 150.0/32	9036250000	E.9
H 150/54 YELLOW	9028230000	E.8
H 185.0/32	9036260000	E.9
HDC-KIT-HA 03.300	1712560000	C.2
HDC-KIT-HA 03.301	1712570000	C.2
HDC-KIT-HA 03.301 M	1802460000	C.2
HDC-KIT-HA 03.302	1712580000	C.2
HDC-KIT-HA 03.302 M	1802450000	C.2
HDC-KIT-HA 03.404	1712630000	C.2
HDC-KIT-HA 04.400	1712690000	C.2
HDC-KIT-HA 04.400M	1802440000	C.2
HDC-KIT-HA 04.40		

Description	Part Number	Page
POZ 24VDC/230VAC 2A	8610930000	D.10
POZ 24VDC/230VAC 4A	8610980000	D.10
PPE 2.5/4	1896170000	A.16
PPE 2.5/4/3AN	1896200000	A.16
PPE 2.5/4/4AN	1896160000	A.16
PRC RETAINING CLIP PRS/PRZ	8536700000	D.8
PRC RETAINING CLIP PRS/PRZ	8536700000	D.8
PRINTJET II 115VAC	1858980000	F.28
PRINTJET II CLEANING UNIT	1858950000	F.28
PRS 12VDC LD 1CO COMPLETE	8536471001	D.6
PRS 12VDC LD 2CO COMPLETE	8536501001	D.6
PRS 24VAC LD 1CO COMPLETE	8536530000	D.8
PRS 24VAC LD 2CO COMPLETE	8536560000	D.8
PRS 24VDC LD 1CO COMPLETE	8536621001	D.6
PRS 24VDC LD 2CO COMPLETE	8536631001	D.6
PRS 115VDC LD 1CO COMPLETE	8536510000	D.8
PRS 115VDC LD 2CO COMPLETE	8536520000	D.8
PRS 120VAC LD 1CO COMPLETE	8536641001	D.8
PRS 120VAC LD 2CO COMPLETE	8536661001	D.8
PRS 230VAC LD 1CO COMPLETE	8536671001	D.8
PRS 230VAC LD 2CO COMPLETE	8536681001	D.8
PRZ 24VAC LD 1CO COMPLETE	8536651001	D.8
PRZ 24VAC LD 2CO COMPLETE	8536681001	D.8
PRZ 24VDC LD 1CO COMPLETE	8536691001	D.6
PRZ 24VDC LD 2CO COMPLETE	8536701001	D.6
PRZ 115VDC LD 1CO COMPLETE	8536610000	D.8
PRZ 115VDC LD 2CO COMPLETE	8536630000	D.8
PRZ 120VAC LD 1CO COMPLETE	8530710000	D.8
PRZ 120VAC LD 2CO COMPLETE	8530720000	D.8
PRZ 12VDC LD 1CO COMPLETE	8536571001	D.6
PRZ 12VDC LD 2CO COMPLETE	8536591001	D.6
PRZ 230VAC LD 1CO COMPLETE	8530731001	D.8
PRZ 230VAC LD 2CO COMPLETE	8530741001	D.8
PUNCH DOWN TOOL PDT	9013970000	G.7
PZ 1.5	9005990000	E.10
PZ 1.5	9005990000	E.3
PZ 3 CRIMP TOOL,22-10AWG	0567330000	E.10
PZ 3 CRIMP TOOL,22-10AWG	0567330000	E.3
PZ 4 FERRULE CRIMPER 0.5-4MM2	9012500000	E.10
PZ 4 FERRULE CRIMPER 0.5-4MM2	9012500000	E.3
PZ 50 CRIMP TOOL,4-1/0AWG	9006450000	E.10
PZ 50 CRIMP TOOL,4-1/0AWG	9006450000	E.3
PZ 6 HEX	9013650000	E.10
PZ 6 HEX	9013650000	E.3
PZ 6 ROTO	9014350000	E.10
PZ 6 ROTO	9014350000	E.3
PZ 6/5 FERRULE CRIMPER	9011460000	E.10
PZ 6/5 FERRULE CRIMPER	9011460000	E.3
PZ ZH16 FOR TWIN FERRULES	9013600000	E.10
PZ ZH16 FOR TWIN FERRULES	9013600000	E.3
PZ16 CRIMP TOOL/METRIC CABLES	9012600000	E.10
PZ16 CRIMP TOOL/METRIC CABLES	9012600000	E.3
Q		
QB 2 FOR 6/6.5MM TB,2 POLE	0482700000	D.10
QB 2 FOR 6/6.5MM TB,2 POLE	0482700000	D.6
QB 2 FOR 6/6.5MM TB,2 POLE	0482700000	D.18
QB 2 FOR 8MM TB,2 POLE	0461100000	D.18
QB 3 FOR 6/6.5MM TB,3 POLE	0482800000	D.10
QB 3 FOR 6/6.5MM TB,3 POLE	0482800000	D.6
QB 3 FOR 6/6.5MM TB,3 POLE	0482800000	D.18
QB 3 FOR 8MM TB,3 POLE	0461200000	D.18
QB 4 FOR 6/6.5MM TB,4 POLE	0482900000	D.10
QB 4 FOR 6/6.5MM TB,4 POLE	0482900000	D.18
QB 4 FOR 8MM TB,4 POLE	0461300000	D.18
QB 58 FOR 8MM TB,58 POLE,ANGLE	0545300000	D.18
QB 58 FOR 8MM TB,58 POLE,STRAI	0545400000	D.18
QB 75 FOR 6MM TB,75 POLE,ANGLE	0526400000	D.10
QB 75 FOR 6MM TB,75 POLE,ANGLE	0526400000	D.18
QB 75 FOR 6MM TB,75 POLE,ANGLE	0526400000	D.18
QB 75 FOR 6MM TB,75 POLE,STRAI	0535200000	D.10
QB 75 FOR 6MM TB,75 POLE,STRAI	0535200000	D.6
QB 75 FOR 6MM TB,75 POLE,STRAI	0535200000	D.18
R		
RCM KIT 115VAC 4CO LED RED	8810150000	D.8
RCM KIT 24VDC 4CO LED	8798740000	D.6
RCM KIT 24VDC 4CO LED GREEN	7940007063	D.6
RCM KIT Z 115VAC 4 CO LDRT	8810080000	D.8
RED STRIP FERRULES	9004340000	E.8
RS 30 110VAC,SPST,NO,GRN CSA	1102111001	D.8
RS 30 24VDC,SPDT,GRN LE CSA	1100210000	D.6
RS 30 24VDC,SPST,NC,GRN CSA	1100911001	D.6
RS 30 24VDC,SPST,NO,GRN CSA	1101611001	D.6
RS 30 24VDC SDT 250V 4A FUSE	37SM400F	D.6
RS-2D/SC FOR 24VDC P/S, 30A	9987390000	D.29
RS70-12V-C1D2-C	330075	D.6
RS-AC/BC 120V SINGLE OUTLET	9915480001	D.4
RS-D 2X20A DIO W/FAN&TEMP.MONI.	7940005219	D.29
RS-D 40A DIODE W/FAN&TEMP.MONI.	7940005218	D.27
RS-DUAL DIODE ARRAY 30A	9987860000	D.27
RS-DUPLEX 120VAC DUAL OUTLET	9915490000	D.4
RS-F10 IDC LP2N	0224961001	D.3
RS-F10 LPK 2H/12	8155610000	D.3
RS-F10 LPK 3/12	8012850000	D.3
RS-F14 IDC LP2N	0225061001	D.3
RS-F14 LPK 2H/16	8258980000	D.3
RS-F14 LPK 3/21	8012860000	D.3
RS-F20 IDC LP2N	0224261001	D.3
RS-F20 LPK 2H/22	8155600000	D.3
RS-F20 LPK 3/21	8012910000	D.3
RS-F34 IDC LP2N	0224361001	D.3

Description	Part Number	Page
RS-F34 LPK 2H/36	8155590000	D.3
RS-F34 LPK 3/36	8012930000	D.3
RS-F40	8155580000	D.3
RS-F40 IDC LP2N	0224461001	D.3
RS-F40 LPK 3/42	8012940000	D.3
RSHV AC, 110V W/O LED	9902860000	D.8
RS-SD 9B FEMALE LP2N	8003911001	D.3
RS-SD 9S MALE LP2N	8003901001	D.3
RS-SD 15B FEMALE LP2N	8005211001	D.3
RS-SD 15S MALE LP2N	8005201001	D.3
RS-SD 25B FEMALE LP2N	8005191001	D.3
RS-SD 25S MALE LP2N	8005181001	D.3
RS-SD 37B FEMALE LP2N	8003891001	D.3
RS-SD 37S MALE LP2N	8003881001	D.3
RS-SD 50B FEMALE LP2N	8005171001	D.3
RS-SD 50S MALE LP2N	8005161001	D.3
S		
SAK 2.5 EN, PA, BEIGE	0218660000	A.6
SAK 2.5/32,KRG,BN	0279620000	A.6
SAK 2.5/32,PA,BG PLASTIC FOOT	0279660000	A.6
SAK 2.5/35,KRG,BN	0380420000	A.6
SAK 2.5/35,PA,BG	0380460000	A.6
SAK 4 EN, PA, BEIGE	0467460000	A.6
SAK 4/32,KRG,BN	0128320000	A.6
SAK 4/32,STEEL SPRING	1716240000	A.6
SAK 4/35,KRG,BN	0443362000	A.6
SAK 4/35,PA,BG	0443360000	A.6
SAK 6 EN, PA, BEIGE	0212860000	A.6
SAK 6 N/32,KRG,BN	0193220000	A.6
SAK 6 N/32,PA,BG	0193260000	A.6
SAK 6/35,KRG,BN	0380520000	A.6
SAK 6/35,PA,BG	0380560000	A.6
SAK 10 EN, PA, BEIGE	0337660000	A.6
SAK 10/32,KRG,BN	0110020000	A.6
SAK 10/32,PA,BG	0110060000	A.6
SAK 10/35,KRG,BN	0443720000	A.6
SAK 10/35,PA,BG	0443760000	A.6
SAK 16 EN, PA, BEIGE	0339760000	A.6
SAK 16/32,KRG,BN	0271020000	A.6
SAK 16/32,PA,BG	0271060000	A.6
SAK 16/35,KRG,BN	0380620000	A.6
SAK 16/35,PA,BG	0380660000	A.6
SAK 35 EN, PA, BEIGE	0339860000	A.6
SAK 35 N/32,SLOT HEAD,PA,BG	0550660000	A.6
SAK 35 N/35,SLOT HEAD,KRG,BN	0608220000	A.6
SAK 35 N/35,SLOT HEAD,PA,BG	0608260000	A.6
SAK 35/32,SLOT HEAD,KRG,BN	0303520000	A.6
SAKC 4/32,NO STB,KRG,BN	0340720000	A.10
SAKC 4/35,NO STB,KRG,BN	0357520000	A.10
SAKC 10/32,2 STB,KRG,BN	0324120000	A.10
SAKC 10/35,2 STB,KRG,BN	1404620000	A.10
SAKR/32,NO STB,KRG,BN	0412120000	A.10
SAKR/32,NO STB,PA,BG	0412160000	A.10
SAKR/35,NO STB,PA,BG	0172160000	A.10
SAKS 1/32,5X20,KRG,BN	0191220000	A.8
SAKS 1/35/5X20, KRG, BROWN	0501620000	A.8
SAKS 1/35/5X20, KRG, WM BEIGE	0501600000	A.8
SAKS 3 G/5X30 500V	0297520000	A.8
SAKS 3/35,5X30,KRG,BN	0328920000	A.8
SAKS 6/32,1-1/4X1/4,KRG,BN	0531820000	A.8
SCHS 2 FBS CARR. STRIP	0337400000	F.22
SCHS GROUP MARK,CARRIER	0138900000	F.22
SCHS2 ADHESIVE MARKING STRIP	1720600000	F.22
SCHS3 K	1753480000	F.22
SCHS4 K	1753460000	F.22
SCHT 5	0292460000	A.17
SCHT 5S	1631930000	A.17
SD 0.4X2.5X75,NON-INSUL,FLAT	9009930000	E.5
SD 0.4X2.0X60,NON-INSUL,FLAT	9037160000	E.5
SD 0.5X3.0X80,NON-INSUL,FLAT	9008320000	E.5
SD 0.6X3.5X100,NON-INSUL,FLAT	9008330000	E.5
SD 0.8X4.0X100,NON-INSUL,FLAT	9008340000	E.5
SD 0.8X4.5X125,NON-INSUL,FLAT	9009020000	E.5
SD 1.0X5.5X150,NON-INSUL,FLAT	9008350000	E.5
SD 1.2X6.5X150,NON-INSUL,FLAT	9009010000	E.5
SD TH30	9009140000	E.5
SD2S 0.6X3.5X200,NON-INSUL,FLAT	9010110000	E.5
SDI 0.4 X 2.5 X 75	9008370000	E.4
SDI 1,INSUL,FLAT,0.5X3.0X100	9008380000	E.4
SDI 1.0X4.5X125	9008910000	E.4
SDI 1.2X6.5X150	9008420000	E.4
SDI 2,INSUL,FLAT,0.6X3.5X100	9008390000	E.4
SDI 3,INSUL,FLAT,0.8X4.0X100	9008400000	E.4
SDI 4,INSUL,FLAT,1.0X5.5X125	9008410000	E.4
SDI 6,INSUL,FLAT,1.6X8.0X175	9008430000	E.4
SDI T8	9201940000	E.4
SDI T10	900964000F	E.4
SDI T15	9009650000	E.4
SDI T20	9009660000	E.4
SDI T25	9009670000	E.4
SDI T30	9009680000	E.4
SDI T40	9009690000	E.4
SDIK PZ1 SCREWDRIVER	9008900000	E.4
SDIK PHILIPS SIZE 1 INSULATED	9008570000	E.4
SDIK PHILIPS SIZE 2 INSULATED	9008580000	E.4
SDIK PHILIPS SIZE 3 INSULATED	9008590000	E.4
SDIK PZ2 SCREWDRIVER	9008890000	E.4
SDIS 2.55-5,5/PH1/2 SET	9009730000	E.6
SDK PHILIPS SIZE 0 NON-INSUL.	9008470000	E.5
SDK PHILIPS SIZE 1 NON-INSUL.	9008480000	E.5
SDK PHILIPS SIZE 2 NON-INSUL.	9008490000	E.5
SDK PHILIPS SIZE 3 NON-INSUL.	9008500000	E.5
SDP PZ0	9008520000	E.5
SDP PZ1	9008530000	E.5

Description	Part Number	Page
SDP PZ2	9008540000	E.5
SDP PZ3	9008550000	E.5
SDS 2.5-5.5/PH1/2	9009740000	E.7
SDTR 25 TORX HEAD SCREWDRIVER	9009150000	E.5
SDTR 8 TORX SCREWDRIVER	9009190000	E.5
SDTR TORX 10 SCREWDRIVER	9009180000	E.5
SDTR TORX 15 SCREWDRIVER	9009170000	E.5
SDTR TORX 20 SCREWDRIVER	9009160000	E.5
SF 0/12 NEUTRAL BL V0	1724050002	F.4
SF 0/12 NEUTRAL GE V0	1724050004	F.4
SF 0/12 NEUTRAL RT V0	1724050003	F.4
SF 0/12 NEUTRAL WS	1724050001	F.4
SF 0/21 NEUTRAL BL V0	1740850002	F.6
SF 0/21 NEUTRAL GE V0	1740850004	F.6
SF 0/21 NEUTRAL RT V0	1740850003	F.6
SF 0/21 NEUTRAL WS	1740850001	F.6
SF 00/12 NEUTRAL BL V0	1740830002	F.4
SF 00/12 NEUTRAL GE V0	1740830004	F.4
SF 00/12 NEUTRAL RT V0	1740830003	F.4
SF 00/12 NEUTRAL WS	1740830001	F.4
SF 00/21 NEUTRAL BL V0	1740840002	F.6
SF 00/21 NEUTRAL GE V0	1740840004	F.6
SF 00/21 NEUTRAL RT V0	1740840003	F.6
SF 00/21 NEUTRAL WS	1740840001	F.6
SF 1/12 NEUTRAL BLUE	1711320002	F.6
SF 1/12 NEUTRAL RED	1711320003	F.6
SF 1/12 NEUTRAL YELLOW	1711320004	F.6
SF 1/12 WHITE	1711320001	F.6
SF 1/21 BLUE (80 MARKERS/CARD)	1696090002	F.6
SF 1/21 RED (80 MARKERS/CARD)	1696090003	F.6
SF 1/21 WHITE (80 MARKERS/CARD)	1696090001	F.6
SF 1/21 YELLOW 80 MARKERS/CARD	1696090004	F.6
SF 2/12 BLANK WHITE	1711350001	F.6
SF 2/12 NEUTRAL BLUE	1711350002	F.6
SF 2/12 NEUTRAL RED	1711350003	F.6
SF 2/12 NEUTRAL YELLOW	1711350004	F.6
SF 2/21 BLUE 80 MARKERS/CARD	1696100002	F.6
SF 2/21 RED 80 MARKERS/CARD	1696100003	F.6
SF 2/21 WHITE 80 MARKERS/CARD	1696100001	F.6
SF 2/21 YELLOW 80 MARKERS/CARD	1696100004	F.6
SF 3/12 BLANK WHITE	1711370001	F.6
SF 3/12 NEUTRAL BLUE	1711370002	F.6
SF 3/12 NEUTRAL RED	1711370003	F.6
SF 3/12 NEUTRAL YELLOW	1711370004	F.6
SF 3/21 BLANK WHITE	1696110001	F.6
SF 3/21 BLUE (64 MARKERS/CARD)	1696110002	F.6
SF 3/21 RED 64 MARKERS/CARD	1696110003	F.6
SF 3/21 YELLOW 64 MARKERS/CARD	1696110004	F.6
SF 4,5/21 NEUTRAL BL V0	1740860002	F.8
SF 4,5/21 NEUTRAL GE V0	1740860004	F.8
SF 4,5/21 NEUTRAL RT V0	1740860003	F.8
SF 4,5/21 NEUTRAL WHITE	1740860001	F.8
SF 4/12 NEUTRAL BL V0	1743490002	F.6
SF 4/12 NEUTRAL RT V0	1743490003	F.6
SF 4/12 NEUTRAL WS	1743490001	F.6
SF 4/12 NEUTRAL YELLOW	1743490004	F.10
SF 4/12 NEUTRAL YELLOW	1743490004	F.6
SF 4/21 BLUE	1696120002	F.8
SF 4/21 NEUTRAL GE V0	1696120004	F.8
SF 4/21 RED	1696120003	F.8
SF 4/21 WHITE	1696120001	F.8
SF 5/12 NEUTRAL BL V0	1743500002	F.6
SF 5/12 NEUTRAL RT V0	1743500003	F.6
SF 5/12 NEUTRAL WS	1743500001	F.6
SF 5/12 NEUTRAL YELLOW	1743500004	F.6
SF 5/21 NEUTRAL BL V0	1696130002	F.8
SF 5/21 NEUTRAL GE V0	1696130004	F.8
SF 5/21 NEUTRAL RT V0	1696130003	F.8
SF 5/21 NEUTRAL WS	1696130001	F.8
SF 6/21 NEUTRAL BL V0	1740870002	F.8
SF 6/21 NEUTRAL GE V0	1740870004	

Description	Part Number	Page	Description	Part Number	Page	Description	Part Number	Page
WAZ4 WAVEPRO FREQUENCY	8581190000	D.25	WPT 3-20 WIRE MARKERS	1764300000	F.16	ZQV 2.5N/2 SW (BLACK)	1718080000	D.12
WAZ5 CCC 0-20/0-20MA	8540190000	D.19	WPT 3-30	1889550000	F.16	ZQV 2.5N/2 SW (BLACK)	1718080000	D.22
WAZ5 CCC HF 0-20/0-20MA	8447170000	D.19	WS 8/5 FOR MULTICARD SYSTEM	1640740000	F.2	ZQV 4/10	1609030000	D.12
WAZ5 CCC LP 2CH. 0-20MA C1D2	8463590000C1D2	D.19	WS 10/12 MC NEUTRAL	1905970000	F.2	ZQV 4/10	1609030000	D.6
WAZ5 CCC LP 2CH. 0-20MA/0-20MA	8463590000	D.19	WS 10/15 MC NEUTR.	1854090000	F.2	ZQV 4/10	1609030000	D.20
WAZ5 CVC 4-20MA/0-10V	8540240000	D.19	WS 10/5 MC MIDD. NEUTR.	1792000000	F.2	ZQV 4/2	1608950000	D.12
WAZ5 CVC HF 4-20/0-10V	8447290000	D.19	WS 10/5 MULTICARD	1635000000	D.12	ZQV 4/2	1608950000	D.20
WAZ5 VCC DC 0-10V/4-20MA	8540300000	D.21	WS 10/5 MULTICARD	1635000000	D.8	ZQV 4/3	1608960000	D.12
WAZ5 VCC HF 0-10V/4-20MA	8447350000	D.21	WS 10/5 MULTICARD	1635000000	D.22	ZQV 4/3	1608960000	D.20
WAZ5 VVC 0-10V/0-10V	8540340000	D.21	WS 10/5 MULTICARD	1635000000	F.2	ZQV 4/4	1608970000	D.12
WAZ5 VVC HF 0-10/0-10V	8447380000	D.21	WS 10/6MC MIDDLE NEUTRAL WHITE	1818400000	F.2	ZQV 4/4	1608970000	D.6
WAZ5 WAVEANALOG DC/ALARM	8543880000	D.19	WS 10/6MC OFFSET NEUTRAL WHITE	1828450000	D.20	ZQV 4/4	1608970000	D.20
WAZ5 WAVEANALOG DC/ALARM	8543880000	D.21	WS 10/6MC OFFSET NEUTRAL WHITE	1828450000	F.2	ZQV 4/5	1608980000	D.20
WAZ5 WAVEANALOG OUTPUT LOOP 2W	8543730000	D.19	WS 10/8 MC NEUTRAL	1895450000	F.2	ZQV 4/6	1608990000	D.20
WAZ5 WAVEPRO BRIDGE	8581210000	D.23	WS 12/3.5 MC NEUTRAL	1778270000	F.2	ZQV 4/7	1609000000	D.20
WAZ5 WAVEPRO RTD	8560710000	D.21	WS 12/5 MULTICARD	1609860000	F.2	ZQV 4/8	1609010000	D.20
WAZ5 WAVEPRO RTD	8560710000	D.23	WS 12/6 MULTICARD	1609900000	D.6	ZQV 4/9	1609020000	D.20
WAZ5 WAVEPRO RTD C1D2	8560710000C1D2	D.21	WS 12/6 MULTICARD	1609900000	F.2	ZQV 4N/10 BLUE	1794050000	D.20
WAZ5 WAVEPRO RTD C1D2	8560710000C1D2	D.23	WS 12/6.5 MC WHITE BLANK	1609920000	F.2	ZQV 4N/10 RED	1794040000	D.20
WAZ5 WAVEPRO THERMO	8560730000	D.23	WS 12/8 MC NEUTRAL	1906000000	F.2	ZQV 4N/2 BLACK	1793970000	D.6
WAZ5 WAVEPRO THERMO C1D2	8560730000C1D2	D.23	WS 14/5 MC NEUTRAL	1768090000	F.2	ZQV 4N/2 BLUE	1793960000	D.6
WDK 2.5 PE	1036300000	A.2	WS 15/5 MULTICARD	1609880000	D.12	ZQV 4N/2 BLUE	1793960000	D.20
WDK 2.5 W/ 2 ZQV PER LEVEL	1041100000	A.2	WS 15/5 MULTICARD	1609880000	D.8	ZQV 4N/2 RED	1793950000	D.6
WDK 2.5,WM,BG	1021500000	A.2	WS 15/5 MULTICARD	1609880000	F.2	ZQV 4N/2 RED	1793950000	D.20
WDK 2.5N PE,YL/GE WM	1041620000	A.2	WSI 4/2	1880430000	A.4	ZQV 4N/3 BLACK	1794000000	D.6
WDK 2.5N V, BG, WM	1041610000	A.2	WSI 4/2 LD 30-70V AC/DC	1880440000	A.4	ZQV 4N/3 BLUE	1793990000	D.6
WDK 2.5N, BG WM	1041600000	A.2	WSI 4/2LD 10-36V AC/DC	1880410000	A.4	ZQV 4N/3 BLUE	1793990000	D.20
WDK 2.5V,WM,BG	1022300000	A.2	WSI 4/2LD 140-250V AC/DC	1880390000	A.4	ZQV 4N/3 RED	1793980000	D.6
WDK 4N BG WM	1041900000	A.2	WSI 4/2LD 60-150V AC/DC	1880420000	A.4	ZQV 4N/3 RED	1793980000	D.20
WDK 4N PE,YL/GE WM	1041920000	A.2	WSI 6 WM NO LED FOR 5X20	1011000000	A.2	ZQV 4N/4 BLUE	1794020000	D.20
WDK 4N V, BG WM	1041910000	A.2	WSI 6/2,1/4,NO LED	1014000000	A.2	ZQV 4N/4 RED	1794010000	D.20
WDU 10,WM,BG	1020300000	A.2	WSI 6/2LD 10-36VAC/DC, WM BG	1014100000	A.2	ZQV 4N/41 BLACK	1794090000	D.6
WDU 120,ALLEN HEAD,WM,BG	1024500000	A.2	WSI 6/2LD 140-250VAC/DC WM BG	1014400000	A.2	ZQV 4N/41 BLUE	1794080000	D.6
WDU 16,WM,BG	1020400000	A.2	WSI 6/2LD 30-70VAC/DC, WM, BG	1014200000	A.2	ZQV 4N/41 BLUE	1794080000	D.20
WDU 2.5,WM,BG	1020000000	A.2	WSI 6/2LD 60-150VAC/DC WM BG	1014300000	A.2	ZQV 4N/41 RED	1794070000	D.6
WDU 240, WEMID BEIGE	1802780000	A.2	WSI 6/LD 10-36VAC/DC WM BG	1011300000	A.2	ZQV 4N/41 RED	1794070000	D.20
WDU 35,FLAT HEAD,WM,BG	1020500000	A.2	WSI 6/LD 140-250VAC/DC, WM BG	1012400000	A.2	ZS 10/5 MC BLANK WHITE	1610000000	F.2
WDU 4,WM,BG	1020100000	A.2	WSI 6/LD 30-70VAC/DC, WM, BG	1012200000	A.2	ZS 12/6 WHITE	1610020000	F.2
WDU 6,WM,BG	1020200000	A.2	WSI 6/LD 60-150VAC/DC WM BG	1012300000	A.2	ZS 15/5 WHITE	1646630000	F.2
WDU 70/95,ALLEN HEAD,WM,BG	1024600000	A.2	WTR 2.5/ZQV BEIGE	1855610000	A.4	ZSI 2.5	1616400000	A.12
WEW 32/1	1067600000	A.16	WTR 2.5/ZQV STB 2.3 BEIGE	1855620000	A.4	ZSI 2.5/2 500AC	1616460000	A.12
WEW 35/1,GF PA, DB	1059000000	A.16	WTR 4 STB, BEIGE WEMID	7910210000	A.4	ZSI 2.5/2LD 10-36VAC/DC	1616470000	A.12
WEW 35/1,GF PA, DB	1059000000	A.18	WTS4 PT 100/2 V OC/0-10V	8432180000	D.23	ZSI 2.5/2LD 30-70VAC/DC	1616480000	A.12
WEW 35/2,GF PA, DB	1061200000	A.16	WTS4 PT100/2 C 0/4-20MA	8432210000	D.23	ZSI 2.5/2LD 60-150VAC/DC	1616490000	A.12
WEW 35/2,GF PA, DB	1061200000	A.18	WTS4 PT100/3 C 0/4-20MA	8432150000	D.23	ZSI 2.5/2LD60-150VDC/140-250VA	1616500000	A.12
WHITE FERRULES 0.75/14 .75/8N	9004290000	E.8	WTS4 PT100/3 DIP SWITCH/0-10V	8432090000	D.23	ZSI 2.5/5X25	1730900000	A.12
WK IK PH 0 FOR DMSI MANUAL	9918460000	E.6	WTS4 PT100/4 C 0/4-20MA	8432270000	D.23	ZSI 2.5/LD 10-36VAC/DC	1616440000	A.12
WK IK PH 1 FOR DMSI MANUAL	9918470000	E.6	WTS4 PT100/4 V 0-10V	8432240000	D.23	ZSI 2.5/LD 30-70VAC/DC	1616430000	A.12
WK IK PH 2 FOR DMSI MANUAL	9918480000	E.6	WTS4 THERMO	8432300000	D.23	ZSI 2.5/LD 60-150VAC/DC	1616420000	A.12
WK IK PZ 0 FOR DMSI MANUAL	9918490000	E.6	WT24 PT 100/2 V OC/0-10V	8432190000	D.23	ZSI 2.5/LD 60-150VDC/140-250VAC	1616410000	A.12
WK IK PZ 1 FOR DMSI MANUAL	9918500000	E.6	WT24 PT 100/3 C 0/4-20MA	8432160000	D.23	ZSI 6-2 2X2.5/G20	1820930000	A.12
WK IK PZ 2 FOR DMSI MANUAL	9918510000	E.6	WT24 PT100/2 C 0/4-20MA	8432220000	D.23	ZSI 6-2/FC, WM BLACK	1814690000	A.12
WK K PH 0 FOR DMS MANUAL	9918570000	E.7	WT24 PT100/3 V 0-10V	8432130000	D.23	ZTR 2.5	1831280000	A.12
WK K PH 1 FOR DMS MANUAL	9918580000	E.7	WT24 PT100/4 C 0/4-20MA	8432250000	D.23	ZTR 2.5/3AN	8731720000	A.12
WK K PH 2 FOR DMS MANUAL	9918590000	E.7	WT24 PT100/4 V OC/0-10V	8432250000	D.23	ZTR 2.5/4AN	7920900000	A.12
WK K PZ 0 FOR DMS MANUAL	9918600000	E.7	WTZ4 THERMO	8432310000	D.23	ZTR 2.5/O.TNHE	1831130000	A.12
WK K PZ 1 FOR DMS MANUAL	9918610000	E.7						
WK K PZ 2 FOR DMS MANUAL	9918620000	E.7						
WK S 0.4X2.5 FOR DMS MANUAL	9918520000	E.7						
WK S 0.5X3.0 FOR DMS MANUAL	9918530000	E.7						
WK S 0.6X3.5 FOR DMS MANUAL	9918540000	E.7						
WK S 0.8X4.0 FOR DMS MANUAL	9918550000	E.7						
WK S 1.0X5.5 FOR DMS MANUAL	9918560000	E.7						
WK SI 0.4X2.5 FOR DMSI MANUAL	9918410000	E.6						
WK SI 0.5X3.0 FOR DMSI MANUAL	9918420000	E.6						
WK SI 0.8X4.0 FOR DMSI MANUAL	9918440000	E.6						
WK SI 1.0X5.5 FOR DMSI MANUAL	9918450000	E.6						
WK SI0.1X3.5 FOR DMSI MANUAL	9918430000	E.6						
WKM 18/43 MARKING SYSTEM	1610700000	F.18	ZDK 2.5-2 PE	1791010000	A.10	91H12-0.5	9925350000	B.3
WKM 8/20	1753490000	F.18	ZDTR 2.5	1745400000	A.12	91H12-1	9925360000	B.3
WKM 8/30	1631910000	F.18	ZDU 1.5, WM, BG	1775480000	A.10	91H12-10	9925430000	B.3
WOS1 15-60VDC/0.5ADC	8237730000	D.12	ZDU 1.5/3AN WM BG	1775530000	A.10	91H12-13	9929820000	B.3
WOS1 3.5-15VDC/100MADC	8275390000	D.10	ZDU 2.5	1608510000	A.10	91H12-16	9925440000	B.3
WOS2 115VUC/2AAC	8259950000	D.12	ZDU 2.5-2	1772060000	A.10	91H12-2	9925380000	B.3
WOS2 115VUC/3ADC	8296250000	D.12	ZDU 4	1632050000	A.10	91H12-20	9925450000	B.3
WOS2 15-60VUC/24-250VAC,3.0A	8275440000	D.12	ZDU 4/3AN	7904180000	A.10	91H12-25	9925460000	B.3
WPE 2.5,WM,GN/YL	1010000000	A.2	ZDU 4-2/2AN BEIGE WEMID	1770370000	A.10	91H12-3	9925390000	B.3
WPE 4,WM,GN/YL	1010100000	A.2	ZDU 6	1608620000	A.10	91H12-32	9925470000	B.3
WPE 6,WM,GN/YL	1010200000	A.2	ZDU 6 / 3AN	7907410000	A.10	91H12-40	9925480000	B.3
WPE 10,WM,GN/YL	1010300000	A.2	ZDU 6-2/2AN	1771380000	A.10	91H12-50	9925490000	B.3
WPE 120	1019700000	A.2	ZDU 10	1746750000	A.10	91H12-63	9925410000	B.3
WPE 16,WM,GN/YL	1010400000	A.2	ZDU 10/3AN	1767690000	A.10	91H12-63	9925500000	B.3
WPE 35,FLAT HEAD,WM,GN/YL	1010500000	A.2	ZDU 16	1745230000	A.10	91H22-0.5	9925660000	B.3
WPE 70/95	1037300000	A.2	ZDU 16/3AN	1768320000	A.10	91H22-1	9925660000	B.3
WPF 1-20 WS/GE NEUTRAL	1600740000	F.20	ZDU 35	1739620000	A.10	91H22-10	9925730000	B.3
WPF 2-17.5 WS/GE NEUTRAL	1764050000	F.20	ZEW 35/2 SCREWLESS END BRACKET	8630740000	A.16	91H22-13	9925740000	B.3
WPM 10-33	1763270000	F.18	ZEW 35/2 SCREWLESS END BRACKET	8630740000	A.18	91H22-16	9925680000	B.3
WPM 20-33	1763280000	F.18	ZEW TS35 SCREWLESS BRACKET	9540000000	A.16	91H22-16	9925700000	B.3
WPM 20-66	1763390000	F.18	ZEW TS35 SCREWLESS BRACKET	9540000000	A.18	91H22-20	9925700000	B.3
WPT 02-12	1764060000	F.16	ZPE 1.5, WM, YL/GN	1775510000	A.10	91H22-25	9925770000	B.3
WPT 02-15	1764070000	F.16	ZPE 2.5	1608640000	A.10	91H22-32	9925700000	B.3
WPT 02-18	1764140000	F.16	ZPE 2.5-2	1772090000	A.10	91H22-40	9925780000	B.3
WPT 02-20 WIRE MARKERS	1764150000	F.16	ZPE 4	1632080000	A.10	91H22-50	9925790000	B.3
WPT 02-30	1889580000	F.16	ZPE 4-2/2AN	1770380000	A.10	91H22-63	9925710000	B.3
WPT 1-12	1764190000	F.16	ZPE 6	1608670000	A.10	91H32-0.5	9925800000	B.3
WPT 1-15 WIRE MARKERS	1764200000	F.16	ZPE 6-2/2AN	1771370000	A.10	91H32-1	9925810000	B.3
WPT 1-18	1764210000	F.16	ZPE 16	1746770000	A.10	91H32-10	9925820000	B.3
WPT 1-20	1764220000	F.16	ZPE 35	1745250000	A.10	91H32-13	9925890000	B.3
WPT 1-30	1889560000	F.16	ZQV 2.5N 1/4-2 BLUE	1739650000	A.10	91H32-16	9929840000	B.3

Part Number	Description	Page
010000000		
0101700000	TST M6,PARALLEL,STEEL	A.17
0110020000	SAK 10/32,KRG,BN	A.6
0110060000	SAK 10/32,PA,BG	A.6
0122800000	TS 32X15X1.5 2M STEEL SOLID	A.16
0124300000	H 16.0/15,6AWG,UNINSULATED	E.9
0124400000	H 25.0/15,4AWG,UNINSULATED	E.9
0124700000	H 6.0/15,10AWG,UNINSULATED	E.9
0124800000	H 10.0/15,8AWG,UNINSULATED	E.9
0128320000	SAK 4/32,KRG,BN	A.6
0138900000	SCHS GROUP MARK,CARRIER	F.22
0139000000	ESO F.GRP MARK CARRIER	F.22
0139200000	SST F.GRP MARK CARRIER	F.22
0164000000	TSTW M6,ANGLED,STEEL	A.17
0172160000	SAKR/35,NO STB,PA,BG	A.10
0178100000	TSTW M5,ANGLED,STEEL	A.17
0186100000	H 2.5/12,14AWG,UNINSULATED	E.9
0186500000	H 1.5/10,16AWG,UNINSULATED	E.9
0190160000	EK 16/35,PA,GN/YL	A.8
0191220000	SAKS 1/32,5X20,KRG,BN	A.8
0191900000	H 6.0/12,10AWG,UNINSULATED	E.9
0193220000	SAK 6 N/32,KRG,BN	A.6
0193260000	SAK 6 N/32,PA,BG	A.6
0199360000	EWK 2 FOR TS 32,PA,BG	A.16
0199360000	EWK 2 FOR TS 32,PA,BG	A.18

020000000

0206160000	EWK 1 FOR TS 32,PA,BG	A.16
0206160000	EWK 1 FOR TS 32,PA,BG	A.18
0212860000	SAK 6 EN, PA, BEIGE	A.6
0218660000	SAK 2.5 EN, PA, BEIGE	A.6
0222760001	ASK1EN/SMT100-50VUC BFI H-	A.8
0224261001	RS-F20 IDC LP2N	D.3
0224361001	RS-F34 IDC LP2N	D.3
0224461001	RS-F40 IDC LP2N	D.3
0224961001	RS-F10 IDC LP2N	D.3
0225061001	RS-F14 IDC LP2N	D.3
0225560001	ASK1EN/SMT100-250VUC BFI H-	A.8
0236400000	TS 35X15X1.5 2M STEEL SOLID	A.16
0236500000	TS 35X15X1.5 2M STEEL M5 SLOT	A.16
0244100000	H 4.0/12,12AWG,UNINSULATED	E.9
0271020000	SAK 16/32,KRG,BN	A.6
0271060000	SAK 16/32,PA,BG	A.6
0279620000	SAK 2.5/32,KRG,BN	A.6
0279660000	SAK 2.5/32,PA,BG PLASTIC FOOT	A.6
0282600000	H 0.5/6,26-22AWG,UNINSULATED	E.9
0282700000	H 0.75/6,20AWG,UNINSULATED	E.9
0282800000	H 1.0/10,18AWG,UNINSULATED	E.9
0282900000	H 10.0/12,8AWG,UNINSULATED	E.9
0292460000	SCHT 5	A.17
0294000000	STR5 FOR SCHT5	A.17
0295900000	BS M5X8 HEX F.TST/TSTW,ST	A.17
0297520000	SAKS 3 G/5X30 500V	A.8
0299860000	SH1 BUSBAR SUPPORT,PA,BG	A.17

030000000

0303520000	SAK 35/32,SLOT HEAD,KRG,BN	A.6
0317000000	H 25.0/29,4AWG,INS,BROWN	E.8
0317100000	H 25.0/35,4AWG,INS,BROWN	E.8
0317200000	H 35.0/30,2AWG,INS,BEIGE	E.8
0317300000	H 35.0/39,2AWG,INS,BEIGE	E.8
0324120000	SAKC 10/32.2 STB,KRG,BN	A.10
0328920000	SAKS 3/35,5X30,KRG,BN	A.8
0334900000	MB FOR TS32, M6/M4, GREY	A.17
0337400000	SCHS 2 FBS CARR. STRIP	F.22
0337660000	SAK 10 EN, PA, BEIGE	A.6
0339760000	SAK 16 EN, PA, BEIGE	A.6
0339860000	SAK 35 EN, PA, BEIGE	A.6
0340720000	SAKC 4/32,NO STB,KRG,BN	A.10
0353500000	BS M6X12 HEX F.TST/TSTW,ST	A.17
0354560000	EK 4/32,PA,GN/YL	A.8
0354660000	EK 10/32,PA,GN/YL	A.8
0354760000	EK 35/32,PA,GN/YL	A.8
0357520000	SAKC 4/35,NO STB,KRG,BN	A.10
0368900000	H 35.0/18,2AWG,UNINSULATED	E.9
0372600000	H 1.0/6,18AWG,UNINSULATED	E.9
0372700000	H 1.5/7,16AWG,UNINSULATED	E.9
0373000000	H 2.5/7,14AWG,UNINSULATED	E.9
0373100000	H 4.0/9,12AWG,UNINSULATED	E.9
0374660000	EK 16/32,PA,GN/YL	A.8
0375200000	H 16/18 6 AWG UNINSULATED	E.9
0375300000	H 25.0/18,2AWG,UNINSULATED	E.9
0379300000	H 10.0/18,8AWG,UNINSULATED	E.9
0380420000	SAK 2.5/35,KRG,BN	A.6
0380460000	SAK 2.5/35,PA,BG	A.6
0380520000	SAK 6/35,KRG,BN	A.6
0380560000	SAK 6/35,PA,BG	A.6
0380620000	SAK 16/35,KRG,BN	A.6
0380660000	SAK 16/35,PA,BG	A.6
0383400000	TS 35X7.5X1.0 2M STEEL SOLID	A.16
0383560000	EW 35 FOR TS 35,PA,BG	A.16
0383560000	EW 35 FOR TS 35,PA,BG	A.18

040000000

0401460000	SH 1 SOCKET BASE ONLY	A.17
0409500000	H 0.5/12,20 AWG,INS, ORANGE	E.8

Part Number	Description	Page
0409600000	H 0.75/12,18AWG,INS,WHITE	E.8
0409700000	H 1.0/12,18AWG,INS,YELLOW	E.8
0412120000	SAKR/32,NO STB,KRG,BN	A.10
0412160000	SAKR/32,NO STB,PA,BG	A.10
0443620000	SAK 4/35,KRG,BN	A.6
0443660000	SAK 4/35,PA,BG	A.6
0443720000	SAK 10/35,KRG,BN	A.6
0443760000	SAK 10/35,PA,BG	A.6
0444200000	H 50.0/37,1/0 AWG INS. OLIVE	E.8
0461100000	QB 2 FOR 8MM TB,2 POLE	D.18
0461200000	QB 3 FOR 8MM TB,3 POLE	D.18
0461300000	QB 4 FOR 8MM TB,4 POLE	D.18
0462900000	H 0.75/14,18AWG,INS,WHITE	E.8
0463000000	H 1.0/14,18AWG,INS,YELLOW	E.8
0463100000	H 1.5/14,16AWG,INS,RED	E.8
0467460000	SAK 4 EN, PA, BEIGE	A.6
0473360000	DEKAFIX 5MM BLANK - WHITE	D.24
0474360000	EK 2.5 N/32,PA,GN/YL	A.8
0474560000	ASK 1 EN, NO LED, PA, BG	A.8
0482700000	QB 2 FOR 6/6.5MM TB,2 POLE	D.6
0482700000	QB 2 FOR 6/6.5MM TB,2 POLE	D.10
0482700000	QB 2 FOR 6/6.5MM TB,2 POLE	D.18
0482800000	QB 3 FOR 6/6.5MM TB,3 POLE	D.6
0482800000	QB 3 FOR 6/6.5MM TB,3 POLE	D.10
0482800000	QB 3 FOR 6/6.5MM TB,3 POLE	D.18
0482900000	QB 4 FOR 6/6.5MM TB,4 POLE	D.6
0482900000	QB 4 FOR 6/6.5MM TB,4 POLE	D.10
0482900000	QB 4 FOR 6/6.5MM TB,4 POLE	D.18
0492500000	H 16.0/12,6AWG,UNINSULATED	E.9
0494920000	SH 2 RAIL HOLDER,KRG,BN	A.17
0495160000	EWK 1 FOR TS 32 SLOT,PA,BG	A.18
0495160000	EWK 1 FOR TS 32 SLOT,PA,BG	A.16
0495660000	MOFU 35	A.17
0498000000	TS 35X15X2.3 2M STEEL SOLID	A.16

050000000

0501600000	SAKS 1/35/5X20, KRG, WM BEIGE	A.8
0501620000	SAKS 1/35/5X20, KRG, BROWN	A.8
0503500000	MB FOR TS 32, M3/M5, CREAM	A.17
0508400000	STI-S FINE PEN BLK FOR PLOTTER	F.29
0514400000	TS 32X15X1.5 2M STEEL M5 SLOT	A.16
0514500000	TS 35X7.5X1.0 2M STEEL M5 SLOT	A.16
0526400000	QB 75 FOR 6MM TB,75 POLE,ANGLE	D.6
0526400000	QB 75 FOR 6MM TB,75 POLE,ANGLE	D.10
0526400000	QB 75 FOR 6MM TB,75 POLE,ANGLE	D.18
0526700000	IP 75 FOR QB 75,75 POLE,6MM	D.6
0526700000	IP 75 FOR QB 75,75 POLE,6MM	D.10
0526700000	IP 75 FOR QB 75,75 POLE,6MM	D.18
0531820000	SAKS 6/32,1-1/4X1/4,KRG,BN	A.8
0533500000	H 6.0/20,10AWG,INS,BLACK	E.8
0534200000	H 10.0/21,8AWG,INS,IVORY	E.8
0535200000	QB 75 FOR 6MM TB,75 POLE,STRAI	D.6
0535200000	QB 75 FOR 6MM TB,75 POLE,STRAI	D.10
0535200000	QB 75 FOR 6MM TB,75 POLE,STRAI	D.18
0535200000	H 0.75/10,20AWG,UNINSULATED	E.9
0535200000	QB 58 FOR 8MM TB,58 POLE,ANGLE	D.18
0535200000	QB 58 FOR 8MM TB,58 POLE,ANGLE	D.18
0535200000	IP 58 FOR QB 58,58 POLE,8MM	D.18
0550660000	SAK 35 N/32,SLOT HEAD,PA,BG	A.6
0553400000	MB FOR TS32, M5/M3, BLACK	A.17
0565600000	H 1.5/24,16AWG,INS,RED	E.8
0565700000	H 6.0/26,10AWG,INS,BLACK	E.8
0565800000	H 10.0/27,8AWG,INS,IVORY	E.8
0565900000	H 16.0/22,6AWG,INS,GREEN	E.8
0566000000	H 16.0/28,6AWG,INS,GREEN	E.8
0567300000	PZ 3 CRIMP TOOL,22-10AWG	E.10
0567300000	PZ 3 CRIMP TOOL,22-10AWG	E.3

060000000

0608220000	SAK 35 N/35,SLOT HEAD,KRG,BN	A.6
0608260000	SAK 35 N/35,SLOT HEAD,PA,BG	A.6
0635100000	H 1.5/16,16AWG,INS,RED	E.8
0635900000	SH1 CLIP ONLY (BULK PACKAGING)	A.17
0636800000	FMS (M5)	A.17
0636900000	FM6 (M6) FOR TS 35	A.17
0641720000	SH 2 S	A.17
0642600000	BS M6X8 HEX F.TST/TSTW,ST	A.17
0642600000	MOUNTING FOOT, TS 35	A.17
0661060000	EK 2.5/35,PA,GN/YL	A.8
0661160000	EK 4/35,PA,GN/YL	A.8
0661260000	EK 6/35,PA,GN/YL	A.8
0661360000	EK 10/35,PA,GN/YL	A.8
0661460000	EK 35/35,PA,GN/YL	A.8
0676100000	TS 32X15X1.5 2M STEEL M6 SLOT	A.16
0676200000	TS 35X7.5X1.0 2M STEEL M6 SLOT	A.16
0687360000	DKT 4/32,PA,BG	A.10
0687460000	DKT 4/35,PA,BG	A.10
0687560000	AP FOR DKT 4, PA,BG	D.10
0687560000	AP FOR DKT 4, PA,BG	D.6
0687900000	FM 4 MOUNTING FOOT FOR TS 35	A.17
0690700000	H 0.5/14,20AWG,INS,ORANGE	E.8

100000000

1010000000	WPE 2.5,WM,GN/YL	A.2
1010100000	WPE 4,WM,GN/YL	A.2
1010200000	WPE 6,WM,GN/YL	A.2
1010300000	WPE 10,WM,GN/YL	A.2
1010400000	WPE 16,WM,GN/YL	A.2
1010500000	WPE 35,FLAT HEAD,WM,GN/YL	A.2
1011000000	WSI 6 WM NO LED FOR 5X20	A.2
1011300000	WSI 6/LD 10-36VAC/DC WM BG	A.2

Part Number	Description	Page
1012200000	WSI 6/LD 30-70VAC/DC, WM, BG	A.2
1012300000	WSI 6/LD 60-150VAC/DC WM BG	A.2
1012400000	WSI 6/LD 140-250VACDC, WM BG	A.2
1014000000	WSI 6/2,1/4,NO LED	A.2
1014100000	WSI 6/2/LD 10-36VAC/DC, WM BG	A.2
1014200000	WSI 6/2/LD 30-70VAC/DC, WM, BG	A.2
1014300000	WSI 6/2/LD 60-150VAC/DC WM BG	A.2
1014400000	WSI 6/2/LD 140-250VAC/DC WM BG	A.2
1019700000	WPE 120	A.2
1020000000	WDU 2.5,WM,BG	A.2
1020100000	WDU 4,WM,BG	A.2
1020200000	WDU 6,WM,BG	A.2
1020300000	WDU 10,WM,BG	A.2
1020400000	WDU 16,WM,BG	A.2
1020500000	WDU 35,FLAT HEAD,WM,BG	A.2
1021500000	WDK 2.5,WM,BG	A.2
1022300000	WDK 2.5V,WM,BG	A.2
1024500000	WDU 120,ALLEN HEAD,WM,BG	A.2
1024600000	WDU 70/95,ALLEN HEAD,WM,BG	A.2
1036300000	WDK 2.5 PE	A.2
1037300000	WPE 70/95	A.2
1041100000	WDK 2.5 W/ 2 ZOV PER LEVEL	A.2
1041600000	WDK 2.5N, BG WM	A.2
1041610000	WDK 2.5N V, BG, WM	A.2
1041620000	WDK 2.5N PE YL/GE WM	A.2
1041900000	WDK 4N BG WM	A.2
1041910000	WDK 4N V, BG WM	A.2
1041920000	WDK 4N PE YL/GE WM	A.2
1059000000	WEW 35/1,GF PA, DB	A.16
1059000000	WEW 35/1,GF PA, DB	A.18
1061200000	WEW 35/2,GF PA, DB	A.16
1061200000	WEW 35/2,GF PA, DB	A.18
1067600000	WEW 32/1	A.16

110000000

1100210000	RS 30 24VDC;SPDT;GRN LE	CSA	D.6
1100911001	RS 30 24VDC;SPST NC;GRN	CSA	D.6
1101611001	RS 30 24VDC;SPST NO;GRN	CSA	D.6
1102111001	RS 30 110VAC;SPST NO;GR	CSA	D.8

120000000

Part Number	Description	Page
1616400000	ZSI 2.5	A.12
1616410000	ZSI 2.5/LD 60-150VDC/140-250VAC	A.12
1616420000	ZSI 2.5/LD 60-150VAC/DC	A.12
1616430000	ZSI 2.5/LD 30-70VAC/DC	A.12
1616440000	ZSI 2.5/LD 10-36VAC/DC	A.12
1616460000	ZSI 2.5/2 500AC	A.12
1616470000	ZSI 2.5/2/LD 10-36VAC/DC	A.12
1616480000	ZSI 2.5/2/LD 30-70VAC/DC	A.12
1616490000	ZSI 2.5/2/LD 60-150VAC/DC	A.12
1616500000	ZSI 2.5/2/LD60-150VDC/140-250VA	A.12

1630000000

1631350000	ESO 5 YELLOW	F.20
1631910000	WKM 8/30	F.18
1631920000	ESOS5 F. SCHT5S(140 PER SHEET)	A.17
1631930000	SCHT 5S	A.17
1631940000	SDRS FOR SCHT5S	A.17
1632050000	ZDU 4	A.10
1632080000	ZPE 4	A.10
1634780000	ESO 7 A4 PAPER YELLOW	F.20
1635000000	WS 10/5 MULTICARD	D.12
1635000000	WS 10/5 MULTICARD	D.8
1635000000	WS 10/5 MULTICARD	D.22
1635000000	WS 10/5 MULTICARD	F.2

1640000000

1640740000	WS 8/5 FOR MULTICARD SYSTEM	F.2
1646630000	ZS 15/5 WHITE	F.2

1650000000

1652220000	ESG 8/19 MULTICARD NEUTRAL	F.22
------------	----------------------------	------

1670000000

1670370000	ESO 5 (POLYESTER WHITE)	F.20
1670380000	ESO 5 POLYESTER YELLOW A4	F.20
1670390000	ESO 7 POLYESTER WHITE	F.20
1670400000	ESO 7 POLYESTER YELLOW A4	F.20
1674740000	ESG 8/17 MULTICARD NEUTRAL	F.22
1674760000	ESG 9/17K UNIVERSAL MULTICARD	F.22

1680000000

1680411044	TM-I 20 WHITE MC	F.20
1680411686	TM-I 20 NEUTRAL RED	F.20
1680411687	TM-I 20 YELLOW TAGS	F.20
1680411688	TM-I 20 NEUTRAL GN	F.20
1680411693	TM-I 20 NEUTRAL BL	F.20
1684460000	PCS MCD CLEANER 25ML	F.29
1684470000	PCS MCD INK 22ML	F.29
1689390001	VT SF 1/21 NEUTRAL WS V0	F.10
1689390002	VT SF 1/21 NEUTRAL BL V0	F.10
1689390003	VT SF 1/21 NEUTRAL RT V0	F.10
1689390004	VT SF 1/21 NEUTRAL GE V0	F.10
1689410001	VT SF 2/21 NEUTRAL WS V0	F.10
1689410002	VT SF 2/21 NEUTRAL BL V0	F.10
1689410003	VT SF 2/21 NEUTRAL RT V0	F.10
1689410004	VT SF 2/21 NEUTRAL GE V0	F.10
1689430001	VT SF 3/21 NEUTRAL WS V0	F.10
1689430002	VT SF 3/21 NEUTRAL BL V0	F.10
1689430003	VT SF 3/21 NEUTRAL RT V0	F.10
1689430004	VT SF 3/21 NEUTRAL GE V0	F.10
1689450001	VT SF 4/21 NEUTRAL WS V0	F.10
1689450002	VT SF 4/21 NEUTRAL BL V0	F.10
1689450003	VT SF 4/21 NEUTRAL RT V0	F.10
1689450004	VT SF 4/21 NEUTRAL GE V0	F.10
1689470001	VT SF 5/21 NEUTRAL WS V0	F.10
1689470002	VT SF 5/21 NEUTRAL BL V0	F.12
1689470003	VT SF 5/21 NEUTRAL RT V0	F.12
1689470004	VT SF 5/21 NEUTRAL GE V0	F.10

1690000000

1693800000	ZQV 2.5N/2	D.12
1693800000	ZQV 2.5N/2	D.22
1696090001	SF 1/21 WHITE (80MARKERS/CARD)	F.6
1696090002	SF 1/21 BLUE (80 MARKERS/CARD)	F.6
1696090003	SF 1/21 RED (80 MARKERS/CARD)	F.6
1696090004	SF 1/21 YELLOW 80 MARKERS/CARD	F.6
1696100001	SF 2/21 WHITE 80 MARKERS/CARD	F.6
1696100002	SF 2/21 BLUE 80 MARKERS/CARD	F.6
1696100003	SF 2/21 RED 80 MARKERS/CARD	F.6
1696100004	SF 2/21 YELLOW 80 MARKERS/CARD	F.6
1696110001	SF 3/21 BLANK WHITE	F.6
1696110002	SF 3/21 BLUE (64 MARKERS/CARD)	F.6
1696110003	SF 3/21 RED 64 MARKERS/CARD	F.8
1696110004	SF 3/21 YELLOW 64 MARKERS/CARD	F.6
1696120001	SF 4/21 WHITE	F.8
1696120002	SF 4/21 BLUE	F.8
1696120003	SF 4/21 RED	F.8
1696120004	SF 4/21 NEUTRAL GE V0	F.8
1696130001	SF 5/21 NEUTRAL WS	F.8
1696130002	SF 5/21 NEUTRAL BL V0	F.8
1696130003	SF 5/21 NEUTRAL RT V0	F.8
1696130004	SF 5/21 NEUTRAL GE V0	F.8
1696140001	SFX 9/24 WHITE 32 MARKERS/CARD	F.4
1696140002	SFX 9/24 BLUE 32 MARKERS/CARD	F.4
1696140003	SFX 9/24 RED 32 (MARKERS/CARD)	F.4
1696140004	SFX 9/24 YELLOW 32MARKERS/CARD	F.4

Part Number	Description	Page
1699840000	SM 27/12.5 WHITE	F.24
1699860000	SM 27/18 WHITE	F.24
1699880000	SM 27/12.5 K WS BLANK	F.24

1700000000

1707270000	SM 27/18K NEUTRAL WHITE	F.24
------------	-------------------------	------

1710000000

1711320001	SF 1/12 WHITE	F.4
1711320002	SF 1/12 NEUTRAL BLUE	F.6
1711320003	SF 1/12 NEUTRAL RED	F.6
1711320004	SF 1/12 NEUTRAL YELLOW	F.6
1711350001	SF 2/12 BLANK WHITE	F.6
1711350002	SF 2/12 NEUTRAL BLUE	F.6
1711350003	SF 2/12 NEUTRAL RED	F.6
1711350004	SF 2/12 NEUTRAL YELLOW	F.6
1711370001	SF 3/12 BLANK WHITE	F.6
1711370002	SF 3/12 NEUTRAL BLUE	F.6
1711370003	SF 3/12 NEUTRAL RED	F.6
1711370004	SF 3/12 NEUTRAL YELLOW	F.6
1712340000	ADAPTOR PG 11/NPT 3/8	C.3
1712350000	ADAPTOR PG13.5 - NPT 1/2	C.3
1712360000	PG16-NPT 1/2	C.3
1712370000	PG21 - NPT 3/4	C.3
1712380000	ADAPTOR PG36 - NPT 1 1/4	C.3
1712390000	PG29 - NPT 1	C.3
1712460000	HDC-KIT-HE 06.100	C.2
1712510000	HDC-KIT-HE-10.110	C.2
1712520000	HDC-KIT-HE 16.120	C.2
1712530000	HDC-KIT-HE 24.130	C.2
1712540000	HDC-KIT-HE 32.140	C.2
1712550000	HDC-KIT-HE 48.150	C.2
1712560000	HDC-KIT-HA 03.300	C.2
1712570000	HDC-KIT-HA 03.301	C.2
1712580000	HDC-KIT-HA 03.302	C.2
1712590000	HDC-KIT-HA 04.400	C.2
1712600000	HDC-KIT-HA 04.401	C.2
1712610000	HDC-KIT-HA 04.402	C.2
1712630000	HDC-KIT-HA 03.404	C.2
1712650000	HDC-KIT-HA 04.406	C.2
1712660000	HDC-KIT-HE 06.101	C.2
1712670000	HDC-KIT-HE 10.111	C.2
1712680000	HDC-KIT-HE 16.121	C.2
1712690000	HDC-KIT-HE 24.131	C.2
1712700000	HDC-KIT-HE 06.200	C.2
1712710000	HDC-KIT-HE 10.210	C.2
1712720000	HDC-KIT-HE 16.220	C.2
1712730000	HDC-KIT-HE 24.230	C.2
1713660001	SFX 14/23 NEUTRAL WHITE	F.4
1713660002	SFX 14/23 NEUTRAL BLUE	F.4
1713660003	SFX 14/23 NEUTRAL RED	F.4
1713660004	SFX 14/23 NEUTRAL YELLOW	F.4
1713700000	SM 27/12.5 NEUTRAL SILVER	F.24
1713720000	SM 27/12 5K NEUTRAL SI	F.24
1713740000	SM 27/18 NEUTRAL SILVER	F.24
1713760000	SM 27/18 K NEUTRAL SILVER	F.24
1716240000	SAK 4/32,STEEL SPRING	A.6
1716630000	SM-H 27/18 BLACK	F.24
1716640000	SM-H 27/12.5 BLACK HOLDER	F.24
1717900000	ZQV 2.5N/2 RT (RED)	D.12
1717900000	ZQV 2.5N/2 RT (RED)	D.22
1717990000	ZQV 2.5N/2 BL	D.12
1717990000	ZQV 2.5N/2 BL	D.22
1718080000	ZQV 2.5N/2 SW (BLACK)	D.12
1718080000	ZQV 2.5N/2 SW (BLACK)	D.22
1718411044	TM-I 12 NEUTRAL WHITE	F.20
1718411686	TM-I 12 NEUTRAL RT	F.20
1718411687	TM-I 12 NEUTRAL YELLOW	F.20
1718411688	TM-I 12 NEUTRAL GN	F.20
1718411693	TM-I 12 NEUTRAL BL	F.20
1718431044	TM-I 18 NEUTRAL WHITE	F.20
1718431686	TM-I 18 NEUTRAL RT	F.20
1718431687	TM-I 18 NEUTRAL YELLOW	F.20
1718431688	TM-I 18 NEUTRAL GN	F.20
1718431693	TM-I 18 NEUTRAL BL	F.20
1718470001	VT SF 1/12 NEUTRAL WS V0	F.8
1718470002	VT SF 1/12 NEUTRAL BL V0	F.8
1718470003	VT SF 1/12 NEUTRAL RT V0	F.8
1718470004	VT SF 1/12 NEUTRAL GE V0	F.8
1718480001	VT SF 2/12 NEUTRAL WS V0	F.8
1718480002	VT SF 2/12 NEUTRAL BL V0	F.8
1718480003	VT SF 2/12 NEUTRAL RT V0	F.8
1718480004	VT SF 2/12 NEUTRAL GE V0	F.8
1718490001	VT SF 3/12 NEUTRAL WS V0	F.8
1718490002	VT SF 3/12 NEUTRAL BL V0	F.8
1718490003	VT SF 3/12 NEUTRAL RT V0	F.8
1718490004	VT SF 3/12 NEUTRAL GE V0	F.8
1719760000	TM 0/12 HF/HB LABELS	F.16
1719770000	TM 0/18 HF/HB LABELS	F.16
1719780000	TM 1/12 HF/HB	F.16
1719790000	TM 1/18 HF/HB	F.16
1719800000	TM 2/12 HF LABELS	F.16
1719810000	TM 2/18 HF/HB LABEL	F.16
1719820000	TM 3/12 HF/HB	F.16
1719830000	TM 3/18 HF/HB	F.16
1719840000	TM 4/12 HF/HB	F.16
1719850000	TM 4/18 HF/HB	F.16
1719860000	TM 5/12 HF/HB	F.16
1719870000	TM 5/18 HF/HB	F.16
1719880000	TM 6/12 HF/HB	F.16
1719890000	TM 6/18 HF/HB	F.16

1720000000

1720600000	SCHS2 ADHESIVE MARKING STRIP	F.22
1720610000	ESG 8/17 F/MTG BAR SCHS NEUTR	F.22
1720620000	DEK 5/7.5 MC BLANK WHITE	F.2
1724000000	HDC-KIT-HSB 06.500	C.2
1724050001	SF 0/12 NEUTRAL WS	F.4
1724050002	SF 0/12 NEUTRAL BL V0	F.4
1724050003	SF 0/12 NEUTRAL RT V0	F.4
1724050004	SF 0/12 NEUTRAL GE V0	F.4
1724760000	ESG 9/17 WHITE BLANK NO ADHES.	F.20
1727750001	SFX 10/23 NEUTRAL WS	F.4
1727750002	SFX 10/23 NEUTRAL BL	F.4
1727750003	SFX 10/23 RED	F.4
1727750004	SFX 10/23 NEUTRAL GE	F.4

1730000000

1730560001	VT SF 6/21 NEUTRAL WS V0	F.12
1730560002	VT SF 6/21 NEUTRAL BL V0	F.12
1730560003	VT SF 6/21 NEUTRAL RT V0	F.12
1730560004	VT SF 6/21 NEUTRAL GE V0	F.12
1730570001	VT SF 4,5/21 NEUTRAL WS V0	F.10
1730570002	VT SF 4,5/21 NEUTRAL BL V0	F.10
1730570003	VT SF 4,5/21 NEUTRAL RT V0	F.10
1730570004	VT SF 4,5/21 NEUTRAL GE V0	F.10
1730580001	VT SF 00/21 NEUTRAL WS V0	F.10
1730580002	VT SF 00/21 NEUTRAL BL V0	F.10
1730580003	VT SF 00/21 NEUTRAL RT V0	F.10
1730580004	VT SF 00/21 NEUTRAL GE V0	F.10
1730590001	VT SF 0/21 NEUTRAL WS V0	F.10
1730590002	VT SF 0/21 NEUTRAL BL V0	F.10
1730590003	VT SF 0/21 NEUTRAL RT V0	F.10
1730590004	VT SF 0/21 NEUTRAL GE V0	F.10
1730900000	ZSI 2.5/5X25	A.12
1736181044	ESG 7/20	F.20
1736181044	ESG 7/20	F.22
1736181687	ESG 7/20 SIRIUS YELLOW	F.22
1736181696	ESG 7/20 SIRIUS TUEKIS	F.22
1736190000	ESG 8/10	F.22
1739620000	ZDU 35	A.10
1739650000	ZPE 35	A.10

1740000000

1740830001	SF 00/12 NEUTRAL WS	F.4
1740830002	SF 00/12 NEUTRAL BL V0	F.4
1740830003	SF 00/12 NEUTRAL RT V0	F.4
1740830004	SF 00/12 NEUTRAL GE V0	F.4
1740840001	SF 00/21 NEUTRAL WS	F.6
1740840002	SF 00/21 NEUTRAL BL V0	F.6
1740840003	SF 00/21 NEUTRAL RT V0	F.6
1740840004	SF 00/21 NEUTRAL GE V0	F.6
1740850001	SF 0/21 NEUTRAL WS	F.6
1740850002	SF 0/21 NEUTRAL BL V0	F.6
1740850003	SF 0/21 NEUTRAL RT V0	F.6
1740850004	SF 0/21 NEUTRAL GE V0	F.6
1740860001	SF 4.5/21 NEUTRAL WHITE	F.8
1740860002	SF 4.5/21 NEUTRAL BL V0	F.8
1740860003	SF 4.5/21 NEUTRAL RT V0	F.8
1740860004	SF 4.5/21 NEUTRAL GE V0	F.8
1740870001	SF 6/21 NEUTRAL WS	F.8
1740870002	SF 6/21 NEUTRAL BL V0	F.8
1740870003	SF 6/21 NEUTRAL RT V0	F.8
1740870004	SF 6/21 NEUTRAL GE V0	F.8
1743490001	SF 4/12 NEUTRAL WS	F.6
1743490002	SF 4/12 NEUTRAL BL V0	F.6
1743490003	SF 4/12 NEUTRAL RT V0	F.6
1743490004	SF 4/12 NEUTRAL YELLOW	F.10
1743490004	SF 4/12 NEUTRAL YELLOW	F.6
1743500001	SF 5/12 NEUTRAL WS	F.6
1743500002	SF 5/12 NEUTRAL BL V0	F.6
1743500003	SF 5/12 NEUTRAL RT V0	F.6
1743500004	SF 5/12 NEUTRAL YELLOW	F.6
1745230000	ZDU 16	A.10
1745250000	ZPE 16	A.10
1745400000	ZDTR 2.5	A.12
1746030001	VT SF 4/12 NEUTRAL WS V0	F.10
1746030002	VT SF 4/12 NEUTRAL BL V0	F.10
1746030003	VT SF 4/12 NEUTRAL RT V0	F.10
1746040001	VT SF 5/12 NE	

Part Number	Description	Page
1890470000	ESG 8/17 L MC NEUTRAL	F.22
1896110000	PDU 2.5/4	A.16
1896120000	PDU 2.5/4/3AN	A.16
1896130000	PDU 2.5/4/4AN	A.16
1896160000	PPE 2.5/4/4AN	A.16
1896170000	PPE 2.5/4	A.16
1896200000	PPE 2.5/4/3AN	A.16

1900000000

1905490000	M-PRINT PRO SOFTWARE CD	F.30
1905950000	WS 10/8 MC NEUTRAL	F.2
1905970000	WS 10/12 MC NEUTRAL	F.2
1906000000	WS 12/8 MC NEUTRAL	F.2

1910000000

1919870000	ESO 8/20P WS	F.20
1919880000	ESO 8/20P GE	F.20
1919890000	ESO 8/20 WS	F.20
1919900000	ESO 8/20 GE	F.20
1919940000	ESG 5/10 MC NEUTRAL WS	F.22

1920000000

1920640000	PLOTTER PEN 0.25 P-INK	F.29
1920650000	PLOTTER PEN 0.35 P-INK	F.29
1924310000	MCP AP SF 4-6	F.29
1924330000	P-CLEANER	F.29
1924340000	P-INK	F.29
1924350000	MCP PLOTTER COVER	F.29
1924360000	MCP AP	F.29
1924370000	MCP AP LABELS	F.29
1925000000	MCP PLUS	F.29

1930000000

1934330000	CC 30/60 K MC NEUTRAL SI	F.26
1934390000	CC 30/60 K MC NEUTRAL WS	F.26
1934400000	CC 30/60 MC NEUTRAL SI	F.26
1934420000	CC 30/60 MC NEUTRAL WS	F.26
1934430000	CC-H 30/60	F.26
1934440000	ETO CC 30/60 TRANSPARENT	F.26
1934450000	STR CC 30/60 TRANSPARENT	F.26

1950000000

1950820000	SF-TOOL 00-6	F.12
------------	--------------	------

3000000000

330075	RS70-12V-C1D2-2C	D.6
37SM400F	RS30 24VDC SDT 250V 4A FUSE	D.6

7900000000

7901540000	MC5R 12V/24VDC IN 14MA,OUT 4A	D.6
7901550000	MC5R 24V/48VDC IN 7MA,OUT 4A	D.8
7901560000	MC5R 12/24VAC/DC IN15MA,OUT 4A	D.6
7901570000	MC5R 24/48VAC/DC IN 7MA,OUT 4A	D.8
7901580000	MC5RL 5-15VIN/AUX 24VDC,OUT 4A	D.6
7901590000	MC5RL 5-15L LOG/24 VAC/DC	D.6
7901600000	MC5R 115VAC IN 3.5MA/OUT 4A	D.8
7901620000	MC5R 24VDC,7MA/1 FORM C, 6A	D.6
7901690001	MC5O 24VDC/5-34VDC 10A RES	D.10
7904180000	ZDU 4/3AN	A.10
7907410000	ZDU 6 / 3AN	A.10

7910000000

7910210000	WTR 4 STB, BEIGE WEMID	A.4
7914760001	DIN RAIL MOUNTABLE UTILITY BOX	D.4
7918960324	CP-SNT 380-480V 3PH/24VDC,40A	D.26

7920000000

7920210324	CP-SNT 380-480V 3PH/24VDC,25A	D.26
7920400000	WAVEPAK LOOP SPLITTER C1D2,Z2	D.19
7920900000	ZTR 2.5/4AN	A.12
7921570000	SIHA 3/G20/LD 10-36V	A.12
7921580000	SIHA 3/G20/LD 35-70V	A.12
7921590000	SIHA 3/G20/LD 60-150V	A.12
7921600000	SIHA 3/G20/LD 140-250V	A.12
7923450024	MC6RF 24VUC IN/SPST NO 5A FUSE	D.6
7923450120	MC6RF 120VACIN/SPST NO 5A FUSE	D.8
7924270030	TST M6 STRAIGHT 30MM HIGH	A.17
7924270040	TST M6 STRAIGHT 40MM HIGH	A.17
7924270050	TST M6 STRAIGHT 50MM HIGH	A.17
7924270070	TST M6 STRAIGHT 70MM HIGH	A.17
7924270090	TST M6 STRAIGHT 90MM HIGH	A.17
7924273549	TST M6 ANGLED 49MM HIGH	A.17
7924273558	TST M6 ANGLED 58MM HIGH	A.17
7924273568	TST M6 ANGLED 68MM HIGH	A.17
7924273578	TST M6 ANGLED 78MM HIGH	A.17
7924273588	TST M6 ANGLED 88MM HIGH	A.17
7924273598	TST M6 ANGLED 98MM HIGH	A.17
7924740324	CP-SNT 360-500V 3PH/24VDC,12.5	D.26

Part Number	Description	Page
7940000000		

7940000036	GFI OUTLET, 20A, LLP TERMINALS	D.4
7940000037	GFI OUTLET, 15A,LPZF TERMINALS	D.4
7940000063	MCZ50 24VDC/5-34VDC 10A RES	D.10
7940000440	HDC-KIT-HE06.COUPLER	C.3
7940000441	HDC-KIT-HE10.COUPLER	C.3
7940000442	HDC-KIT-HE16.COUPLER	C.3
7940000443	HDC-KIT-HE24.COUPLER	C.3
7940000444	HDC-KIT-HE32.COUPLER	C.3
7940000445	HDC-KIT-HSB6.COUPLER	C.3
7940000446	HDC-KIT-HE06.201 TOP	C.3
7940000447	HDC-KIT-HE06.200 SIDE	C.3
7940000448	HDC-KIT-HE10.211 TOP	C.3
7940000449	HDC-KIT-HE10.210 SIDE	C.3
7940000450	HDC-KIT-HE16.221 TOP	C.3
7940000451	HDC-KIT-HE16.220 SIDE	C.3
7940000452	HDC-KIT-HE24.231 TOP	C.3
7940000453	HDC-KIT-HE24.230 SIDE	C.3
7940000454	HDC-KIT-HE32.240 SIDE	C.3
7940000602	UNIVERSAL I/O MODULE 1 FUSE	D.3
7940000604	UNIVERSAL I/O MODULE 2 FUSES	D.3
7940000628	UNI.QB 2M CABLE 18 CONDUCTOR	D.3
7940004779	MRS 12VDC C1D2 SECURED LEVER	D.6
7940004780	MRS 12VDC C1D2 SECURED LEVER	D.6
7940004781	MRS 24VDC C1D2 SECURED LEVER	D.6
7940004782	MRS 24VDC C1D2 SECURED LEVER	D.6
7940004783	MRS 120VAC C1D2 SECURED LEVER	D.8
7940004784	MRS 120VAC C1D2 SECURED LEVER	D.8
7940005218	RSD 40A DIODE W/FAN&TEMP.MONI.	D.29
7940005219	RSD 2X20A DIO W/FAN&TEMP.MONI.	D.29
7940005471	DECIPAK 4-20MA/4-20MA/120V 4W	D.19
7940005473	DECIPAK 4-20MA/4-20MA/24V 4W	D.19
7940005476	DECIPAK 4-20MA/0-20MA/24V 4W	D.19
7940005478	DECIPAK 4-20MA/0-10V/240V 4W	D.19
7940005482	DECIPAK 4-20MA/0-5V/24V 4W	D.19
7940005485	DECIPAK 0-20MA/4-20MA/24V 4W	D.19
7940005488	DECIPAK 0-20MA/0-20MA/24V 4W	D.19
7940005499	DECIPAK 0-10V/4-20MA/24V 4W	D.21
7940005508	DECIPAK 0-10V/0-5V/24V 4W	D.21
7940005521	DECIPAK 4-20/4-20/LOOP POWERED	D.19
7940005522	DECIPAK 4-20MA/4-20MA/24V 2W	D.19
7940005523	DECIPAK 0-1MA/4-20MA/24V 2W	D.19
7940005524	DECIPAK 0-20MA/4-20MA/24V 2W	D.19
7940005528	DECIPAK 0-10V/4-20MA/24V 2W	D.21
7940005529	DECIPAK 0-10MV/4-20MA/24V 2W	D.21
7940005531	DECIPAK 0-100MV/4-20MA/24V 2W	D.21
7940007063	RCM KIT 24VDC 4CO LED GREEN	D.6
7940023881	MRZ 120VAC RC C1D2	D.8
7940023882	MRS 120VAC RC C1D2	D.8

8000000000

8003881001	RS-SD 37S MALE LP2N	D.3
8003891001	RS-SD 37B FEMALE LP2N	D.3
8003901001	RS-SD 9S MALE LP2N	D.3
8003911001	RS-SD 9B FEMALE LP2N	D.3
8005161001	RS-SD 50S MALE LP2N	D.3
8005171001	RS-SD 50B FEMALE LP2N	D.3
8005181001	RS-SD 25S MALE LP2N	D.3
8005191001	RS-SD 25B FEMALE LP2N	D.3
8005201001	RS-SD 15S MALE LP2N	D.3
8005211001	RS-SD 15B FEMALE LP2N	D.3
8012850000	RS-F10 LPK 3/12	D.3
8012860000	RS-F14 LPK 3/12	D.3
8012910000	RS-F20 LPK 3/21	D.3
8012930000	RS-F34 LPK 3/36	D.3
8012940000	RS-F40 LPK 3/42	D.3
8019590000	DKO 24V DC/O	D.10
8019640000	DKSC 0-10V IN/2 SET POINT OUT	D.21
8028300000	DKO 35 OPTO COUPLER 24 VDC	D.10

8100000000

8155580000	RS-F40	D.3
8155590000	RS-F34 LPK 2H/36	D.3
8155600000	RS-F20 LPK 2H/22	D.3
8155610000	RS-F10 LPK 2H/12	D.3

8200000000

8228640000	DKSO 24VDC 50KHZ/5V TTL OUT	D.10
8228650000	DKO DK5 5VTTU/5-48VDC,100MA	D.12
8237730000	WOS1 15-60VDC/0.5ADC	D.12
8242040000	DK U-F DK5 0-10V E315A	D.21
8258980000	RS-F14 LPK 2H/16	D.3
8259950000	WOS2 115VUC/2AEC	D.12
8260280000	MCZ SC 0-10VDC SET POINT	D.21
8275390000	WOS1 3.5-15VDC/100MADC	D.10
8275440000	WOS2 15-60VUC/24-250VAC,3.0A	D.12
8283810001	DK F-U DK5 0-16KHZ 24V	D.25
8296250000	WOS2 115VUC/3ADC	D.12

8300000000

8311870001	DK F-1 DK5 0-16KHZ	D.25
8324610000	MCZ O 24VDC/5V TTL OUT 50KHZ	D.10
8365940000	MCZ OPTO 24VAC/DC/5-48VDC@20MA	D.10
8389030000	AP FOR MCZ PRODUCTS	D.6
8389030000	AP FOR MCZ PRODUCTS	D.12
8389030000	AP FOR MCZ PRODUCTS	D.12
8389030000	AP FOR MCZ PRODUCTS	D.12
8398940000	MCZ O 5VTTU IN/5-48VDC,100MA	D.12

Part Number	Description	Page
8400000000		

8411190000	MCZ CCC 0-20MA/0-20MA LOOP PWR	D.19
8425720000	MCZ PT100/3 CLP 0-100C	D.21
8432090000	WTS4 PT100/3 DIP SWITCH/0-10V	D.23
8432130000	WTZ4 PT100/3 V 0-10V	D.23
8432150000	WTS4 PT100/3 C 0/4-20MA	D.23
8432160000	WTZ4 PT 100/3 C 0/4-20MA	D.23
8432180000	WTS4 PT 100/2 V 0C/0-10V	D.23
8432190000	WTZ4 PT 100/2 V 0C/0-10V	D.23
8432210000	WTS4 PT100/2 C 0/4-20MA	D.23
8432220000	WTZ4 PT100/2 C 0/4-20MA	D.23
8432240000	WTS4 PT100/4 V 0-10V	D.23
8432250000	WTZ4 PT100/4 V 0C/0-10V	D.23
8432270000	WTS4 PT100/4 C 0/4-20MA	D.23
8432280000	WTZ4 PT100/4 C 0/4-20MA	D.23
8432300000	WTS4 THERMO	D.23
8432310000	WTZ4 THERMO	D.23
8444950000	WAS 5 CCC LP 0-20/0-20MA	D.19
8444950000c1D2	WAS 5 CCC LP 0-20/0-20MA C1D2	D.19
8444960000	WAZ 5 CCC LP 0-20/0-20MA	D.19
8444960000c1D2	WAZ 5 CCC LP 0-20/0-20MA C1D2	D.19
8444980000	WAS4 CCC DC 4-20/0-10V	D.19
8444990000	WAZ4 CCC DC 4-20/0-10V	D.19
8445040000	WAS4 CVC DC 4-20/0-10V	D.19
8445050000	WAZ4 CVC DC 4-20/0-10V	D.19
8445070000	WAS4 CCC DC 0-20/0-20MA	D.19
8445080000	WAZ4 CCC DC 0-20/0-20MA	D.19
8447100000	WAS4 VCC DC 0-10/4-20MA	D.21
8447110000	WAZ4 VCC DC 0-10/4-20MA	D.21
8447130000	WAS4 VVC DC 0-10/0-10V	D.21
8447140000	WAZ4 VVC DC 0-10/0-10V	D.21
8447160000	WAS5 CCC HF 0-20/0-20MA	D.19
8447170000	WAZ5 CCC HF 0-20/0-20MA	D.19
8447280000	WAS5 CVC HF 4-20/0-10V	D.19
8447290000	WAZ5 CVC HF 4-20/0-10V	D.19
8447340000	WAS5 VCC HF 0-10/4-20MA	D.21
8447350000	WAZ5 VCC HF 0-10/4-20MA	D.21
8447370000	WAS5 VVC HF 0-10/0-10V	D.21
8447380000	WAZ5 VVC HF 0-10/0-10V	D.21
8461470000	MCZ VFC 0-10V	D.21
8461480000	MCZ CFC 0-20MA	D.19
8461490000	MCZ CFC 4-20MACLP TO FREQUENCY	D.19
8463580000	WAS5 CCC LP 2CH. 0-20MA/0-20MA	D.19
8463580000	WAS5 CCC LP 2CH. 0-20MA/0-20MA	D.19
8463590000	WAZ5 CCC LP 2CH. 0-20MA/0-20MA	D.19
8463590000c1D2	WAZ5 CCC LP 2CH. 0-20MA C1D2	D.19
8473000000	MCZ PT100/3 CLP -50+150	D.21
8473010000	MCZ PT100/3 CLP 0-200C	D.23
8473020000	MCZ PT100/3 CL	

Part Number	Description	Page
9018650000	H 1,0/15S ZH GE SV	E.11
9018690000	H 1/15 S ZH YELLOW	E.11
9018860000	H 10/24 ZH IVORY STRIP PACK	E.11
9018870000	H 10/30S ZH EB	E.11
9018910000	H 0.25/5 UNINSULATED FERRULES	E.9
9019160000	H 2,5/14D	E.8
9019170000	H 2,5/18 D BLUE FERRULES	E.8
9019180000	H 2,5/25,14AWG, INS, BLUE	E.8
9019190000	H 4/17 D GREY FERRULE	E.8
9019200000	H 4/20D GREY FERRULES	E.8
9019210000	H 4/0/25, 12AWG, INS, GREY	E.8

9020000000

9020000000	STRIPAX PLUS	E.3
9020000000	STRIPAX PLUS	E.10
9025740000	H 0.25/10 LIGHT BLUE	E.8
9025750000	H 0.34/10 TURQUOISE FERRULES	E.8
9025760000	H 0.25/12 LIGHT BLUE FERRULES	E.8
9025770000	H 0.34/12 TURQUOISE FERRULES	E.8
9025780000	H 0.25/12 LIGHT BLUE STRIP PKG	E.8
9025790000	H 0.34/12 FERRULES STRIP PKG	E.8
9025860000	H 0.75/16 WHITE	E.8
9025870000	H 0.5/16 ORANGE FERRULES	E.8
9025880000	H 50.0 FERRULES	E.9
9025910000	AEH 0.75/18	E.8
9025930000	AEH 1.0/18 FERRULES	E.8
9025950000	AEH 1.0/16 FERRULES (YELLOW)	E.8
9026010000	H 4/17 D GREY FERRULES	E.8
9026030000	HO 34/10 TURQUOISE	E.8
9026050000	H 0.25/10,24AWG,INS,LIGHT BLUE	E.8
9026060000	H 0.5/16 ORANGE FERRULES	E.8
9026070000	H 0.75/14 WHITE	E.8
9026080000	H 1/14 YELLOW	E.8
9026090000	H 1.5/14	E.8
9026100000	H 2.5 FERRULES 14	E.8
9028200000	H 70.0/40 YELLOW	E.8
9028210000	H 95/44 RED FERRULES 3/0 AWG	E.8
9028220000	H 120/50 BLUE	E.8
9028230000	H 150/54 YELLOW	E.8
9028240000	H 0.14/12 GREY STRIP PACK	E.8
9028260000	H 0.5/10 ORANGE STRIP PKG	E.8
9028270000	H 0.5/16 OR SV	E.8
9028280000	H 0.75/12 WHITE STRIP PKG	E.8
9028290000	H 0.75/16 WHITE FERRULES	E.8
9028300000	H 0.75/18 W SV	E.8
9028310000	H 1,0/12 GE SV	E.8
9028320000	H 1,0/16 YELLOW STRIP PKG	E.8
9028340000	H 1,0/18 GE SV	E.8
9028350000	H 1.5/16 RED FERRULES STRIP PK	E.8

9030000000

9030060000	AM 12 GRAY	E.2
9030060000	AM 12 GRAY	G.7
9036240000	H 120/32 FERRULES W/O COLLARS	E.9
9036250000	H 150,0/32	E.9
9036260000	H 185,0/32	E.9
9037160000	SD 0.4X2.0X60, NON-INSUL, FLAT	E.5
9037200000	H 0.5/15 ZH ORANGE	E.11
9037210000	H 0.5/16.5 ZH ORANGE FERRULES	E.11
9037220000	H 0.5/18.5 ZH ORANGE TWIN	E.11
9037230000	H 0.75/15 ZH WHITE TWIN FERR	E.11
9037240000	H 0.75/17 ZH WHITE	E.11
9037250000	H 0.75/24, 5 ZH WHITE FERRULES	E.11
9037260000	H 1.0/15 ZH YELLOW FERRULES	E.11
9037270000	H 1.0/20 ZH YELLOW	E.11
9037280000	H 1.0/25.6 ZH YELLOW	E.11
9037290000	H 1.5/16 ZH RED FERRULES	E.11
9037300000	H 1.5/20 ZH RED FERRULES	E.11
9037310000	H 1.5/25 6 ZH RED FERRULES	E.11
9037320000	H 6.0/25 ZH BLACK FERRULES	E.11
9037330000	H 6.0/29 ZH BLACK FERRULES	E.11
9037340000	H 10.0/26 ZH IVORY FERRULES	E.11
9037350000	H 10.0/30 ZH EB	E.11
9037360000	H 16.0/29 TWIN GREEN FERRULE	E.11
9037500000	H 2.5/18 SD 2H BLUE	E.11
9037510000	H 2.5/20.5D 2H BLUE	E.11
9037520000	H 2.5/26, 5D ZH BLUE FERRULES	E.11
9037530000	H 4.0/22D ZH GREY	E.11
9037540000	H 4.0/28D ZH GREY FERRULES	E.11

9050000000

9050340000	CUTTING BLADE FOR STRIPAX PLUS	E.3
9054030000	BLADE SET NEW STRIPAX 6	E.2
9054580000	DIE SET FOR PZ ZH 16	E.3

9100000000

9101000000	MCB 0.5 AMP,1 POLE	B.5
9101100000	MCB 0.8 AMP,1 POLE	B.5
9101200000	MCB 1.0 AMP,1 POLE	B.5
9101300000	MCB 1.2 AMP,1 POLE	B.5
9101400000	MCB 1.5 AMP,1 POLE	B.5
9101500000	MCB 2.0 AMP,1 POLE	B.5
9101600000	MCB 2.5 AMP,1 POLE	B.5
9101700000	MCB 3.0 AMP,1 POLE	B.5
9101800000	MCB 5.0 AMP,1 POLE	B.5
9101900000	MCB 10.0 AMP,1 POLE	B.5
9102000000	MCB 15.0 AMP,1 POLE	B.5
9102100000	ADAPTOR FOOT	B.5
9103000000	MCB 8.0 AMP,1 POLE	B.5

Part Number	Description	Page
9103810000	MCB 6.0 AMP,1 POLE	B.5
9104150000	MCB 7.0 AMP,1 POLE	B.5
9104170000	MCB 0.1 AMP,1 POLE	B.5
9104180000	MCB 0.2 AMP,1 POLE	B.5
9104350000	MCB 4.0 AMP,1 POLE	B.5
9104610000	MCB 9.0 AMP,1 POLE	B.5
9104650000	MCB 0.08 AMP,1 POLE	B.5
9104670000	MCBD 8.0 AMP,2 POLE	B.5
9107830000	MCB 5.5 AMP,1 POLE	B.5
9107840000	MCB 12.0 AMP,1 POLE	B.5
9107850000	MCB 14.0 AMP,1 POLE	B.5

9110000000

9118290001	ASK1EN/SMT100-250VUC BFI H+	A.8
------------	-----------------------------	-----

9120000000

9120040000	MCB 6.5 AMP,1 POLE	B.5
9120350000	MCBD 0.1 AMP,2 POLE	B.5
9123140001	ASK1EN/SMT10-60VUC BFI H+	A.8
9124080000	MCB 0.05 AMP,1 POLE	B.5
9124090000	MCB 0.4 AMP,1 POLE	B.5
9124110000	MCB 0.6 AMP,1 POLE	B.5
9124120000	MCB 1.3 AMP,1 POLE	B.5
9124130000	MCB 1.4 AMP,1 POLE	B.5
9124140000	MCB 1.8 AMP,1 POLE	B.5
9124160000	MCB 3.5 AMP,1 POLE	B.5
9124170000	MCB 4.5 AMP,1 POLE	B.5
9124180000	MCB 11.0 AMP,1 POLE	B.5
9124190000	MCB 13.0 AMP,1 POLE	B.5
9124210000	MCB 16.0 AMP,1 POLE	B.5
9124220000	MCBD 0.05 AMP,2 POLE	B.5
9124230000	MCBD 0.08 AMP,2 POLE	B.5
9124240000	MCBD 0.2 AMP,2 POLE	B.5
9124260000	MCBD 0.3 AMP,2 POLE	B.5
9124270000	MCBD 0.4 AMP,2 POLE	B.5
9124280000	MCBD 0.6 AMP,2 POLE	B.5
9124290000	MCBD 0.7 AMP,2 POLE	B.5
9124310000	MCBD 1.3 AMP,2 POLE	B.5
9124320000	MCBD 1.4 AMP,2 POLE	B.5
9124330000	MCBD 1.8 AMP,2 POLE	B.5
9124340000	MCBD 3.5 AMP,2 POLE	B.5
9124350000	MCBD 4.5 AMP,2 POLE	B.5
9124360000	MCBD 5.5 AMP,2 POLE	B.5
9124370000	MCBD 6.0 AMP,2 POLE	B.5
9124380000	MCBD 6.5 AMP,2 POLE	B.5
9124390000	MCBD 7.0 AMP,2 POLE	B.5
9124420000	MCBD 9.0 AMP,2 POLE	B.5
9124430000	MCBD 11.0 AMP,2 POLE	B.5
9124440000	MCBD 12.0 AMP,2 POLE	B.5
9124450000	MCBD 13.0 AMP,2 POLE	B.5
9124460000	MCBD 14.0 AMP,2 POLE	B.5
9124470000	MCBD 16.0 AMP,2 POLE	B.5
9129560000	MCB 0.7 AMP,1 POLE	B.5
9129580000	MCBD 0.5 AMP,2 POLE	B.5
9129590000	MCBD 0.8 AMP,2 POLE	B.5
9129610000	MCBD 1.0 AMP,2 POLE	B.5
9129620000	MCBD 1.2 AMP,2 POLE	B.5
9129630000	MCBD 1.5 AMP,2 POLE	B.5
9129640000	MCBD 2.0 AMP,2 POLE	B.5
9129650000	MCBD 2.5 AMP,2 POLE	B.5
9129660000	MCBD 3.0 AMP,2 POLE	B.5
9129670000	MCBD 5.0 AMP,2 POLE	B.5
9129680000	MCBD 10.0 AMP,2 POLE	B.5
9129690000	MCBD 15.0 AMP,2 POLE	B.5
9129710000	MCBD 4.0 AMP,2 POLE	B.5
9129810000	MCB 0.3 AMP,1 POLE	B.5

9150000000

9158330001	KDKS1PE/SMT10-60VUC BFI H-	A.8
9158340001	KDKS1PE/SMT10-60VUC BFI H+	A.8
9158350001	KDKS1PE/SMT100-250VUC BFI H-	A.8

9200000000

9201940000	SDI T8	E.4
9202800000	TT 8 RS MP 8	G.7

9400000000

9451000000	H 35,0/30S	E.9
------------	------------	-----

9500000000

9503350000	KDKS 1 EN/35 NO LED, WM, BEIGE	A.8
9528110000	KDKS 1 PE/35 NO LED, WM, BG	A.8
9540000000	ZEW TS35 SCREWLESS BRACKET	A.16
9540000000	ZEW TS35 SCREWLESS BRACKET	A.18

9800000000

9806370000	PICOPAK FREQUENCY DIVIDER DKS	D.25
9802720001	KDKS1EN/SMT10-60VUC BFI H-	A.8
9802760001	KDKS1EN/SMT100-250VUC BFI H-	A.8

Part Number	Description	Page
9900000000		
9902860000	RSHV AC, 110V W/O LED	D.8
9906310000	HVDC 24VAC/DC	D.6
9906660000	OPTO W/O INPUT CURRENT LIMIT	D.12
9908510001	KDKS1EN/SMT10-60VUC BFI H+	A.8
9908800000	PICOPAK I TO I / DK6 WITH AP	D.19
9908810000	PICOPAK 3 WIRE POTENTIOMETER	D.23

9910000000

9910590000	PICOPAK DK6RELAY 24VDC/120VAC	D.8
9911010000	CIRCUIT BREAKER 1P .1A	B.4
9911020000	CIRCUIT BREAKER 1P .2A	B.4
9911030000	CIRCUIT BREAKER 1P .3A	B.4
9911040000	CIRCUIT BREAKER 1P .4A	B.4
9911050000	CIRCUIT BREAKER 1P .5A	B.4
9911060000	CIRCUIT BREAKER 1P .6A	B.4
9911080000	CIRCUIT BREAKER 1P .8A	B.4
9911100000	CIRCUIT BREAKER 1P 1.0A	B.4
9911150000	CIRCUIT BREAKER 1P 1.5A	B.4
9911200000	CIRCUIT BREAKER 1P 2.0A	B.4
9911250000	CIRCUIT BREAKER 1P 2.5A	B.4
9911300000	CIRCUIT BREAKER 1P 3.0A	B.4
9911400000	CIRCUIT BREAKER 1P 4.0A	B.4
9911500000	CIRCUIT BREAKER 1P 5.0A	B.4
9911600000	CIRCUIT BREAKER 1P 6.0A	B.4
9911800000	CIRCUIT BREAKER 1P 8.0A	B.4
9912010000	CIRCUIT BREAKER 2P .1A	B.4
9912020000	CIRCUIT BREAKER 2P .2A	B.4
9912030000	CIRCUIT BREAKER 2P .3A	B.4
9912040000	CIRCUIT BREAKER 2P .4A	B.4
9912050000	CIRCUIT BREAKER 2P .5A	B.4
9912060000	CIRCUIT BREAKER 2P .6A	B.4
9912080000	CIRCUIT BREAKER 2P .8A	B.4
9912100000	CIRCUIT BREAKER 2P 1.0A	B.4
9912150000	CIRCUIT BREAKER 2P 1.5A	B.4
9912200000	CIRCUIT BREAKER 2P 2.0A	B.4
9912250000	CIRCUIT BREAKER 2P 2.5A	B.4
9912300000	CIRCUIT BREAKER 2P 3.0A	B.4
9912400000	CIRCUIT BREAKER 2P 4.0A	B.4
9912500000	CIRCUIT BREAKER 2P 5.0A	B.4
9912600000	CIRCUIT BREAKER 2P 6.0A	B.4
9912800000	CIRCUIT BREAKER 2P 8.0A	B.4
9913010000	CIRCUIT BREAKER 3P .1A	B.4
9913020000	CIRCUIT BREAKER 3P .2A	B.4
9913030000	CIRCUIT BREAKER 3P .3A	B.4
9913040000	CIRCUIT BREAKER 3P .4A	B.4
9913050000	CIRCUIT BREAKER 3P .5A	B.4
9913060000	CIRCUIT BREAKER 3P .6A	B.4
9913080000	CIRCUIT BREAKER 3P .8A	B.4
9913100000	CIRCUIT BREAKER 3P 1.0A	B.4
9913150000	CIRCUIT BREAKER 3P 1.5A	B.4
9913200000	CIRCUIT BREAKER 3P 2.0A	B.4
9913250000	CIRCUIT BREAKER 3P 2.5A	B.4
9913300000	CIRCUIT BREAKER 3P 3.0A	B.4
9913400000	CIRCUIT BREAKER 3P 4.0A	B.4
9913500000	CIRCUIT BREAKER 3P 5.0A	B.4
9913600000	CIRCUIT BREAKER 3P 6.0A	B.4
9913800000	CIRCUIT BREAKER 3P 8.0A	B.4
9915150001	KDKS1PE/SMT100-250VUC BFI H+	D.8
9915480001	RS-AC/CB 120V SINGLE OUTLET	A.4
9915490000	RS-DUPLEX 120VAC DUAL OUTLET	D.4
9915700000	PICOPAK OPT024/120 C/W LEAKAGE	D.10
9915820001	KDKS1EN/SMT100-250VUC BFI H+	A.8
9916010000	PICOPAK MCZ I/I	D.19
9916080000	WAVEPAK MPI-OPTO	D.10
9916090000	CSR CUR. SENS. RELAY RS45 HOUS	D.25
9916240000	PICOPAK MC6/0-5AAC/4-20MA 2W	D.26
9916250024	CP-SNT300W 115-230V/24VDC, 12.5A	D.26
9916280012	CP-BBU 12VDC	D.29
9916280024	CP-BBU 24VDC	D.29
9916290000	MC6 NON-INCENDIVE BARRIER(DIG)	D.5
9916340000	WAVEPAK 0-300VDC/4-20MA/24V 3W	D.21
9916450000	DC CURRENT SENSOR + AMP	D.21
9917790324	CP-SNT 360-480V 3PH/24VDC,2.3A	D.26
9917841000	MC6 INS MAKE BEFORE BREAK TB	D.5
9918010000	MC6 NON-INCENDIVE BARRIER(ANG)	D.5
9918370000	DMS MANUAL 0.5-1.7NM TORQUE	E.7
9918380000	DMS MANUAL 2.0-8.0NM TORQUE	E.7
9918390000	DMS MANUAL 0.5-1.7NM TORQUE	E.6
9918400000	DMS MANUAL 2.0-8.0NM TORQUE	E.6
9918410000	WK SI 0.4X2.5 FOR DMSI MANUAL	E.6
9918420000	WK SI 0.5X3.0 FOR DMSI MANUAL	E.6
9918430000	WK SI0.1X3.5 FOR DMSI MANUAL	E.6
9918440000	WK SI 0.8X4.0 FOR DMSI MANUAL	E.6
99184500		

Notes

Notes

www.weidmuller.ca

Argentina	Ireland	Slovenia
Australia	Israel	South Africa
Austria	Italy	South Korea
Azerbaijan	Japan	Spain
Bahrain	Jordan	Sweden
Belarus	Kazakhstan	Switzerland
Belgium	Kuwait	Syria
Bosnia	Latvia	Taiwan
-Herzegovina	Lebanon	Thailand
Brazil	Lithuania	Turkey
Bulgaria	Luxembourg	UAE
Canada	Macedonia	Ukraine
Chile	Malaysia	United Kingdom
China	Mexico	USA
Colombia	Netherlands	Venezuela
Costa Rica	New Zealand	Vietnam
Croatia	Norway	Yemen
Czech Republic	Oman	
Denmark	Paraguay	
Egypt	Peru	
Estonia	Philippines	
Finland	Poland	
France	Portugal	
Germany	Qatar	
Greece	Romania	
Hong Kong	Russia	
Hungary	Saudi Arabia	
Iceland	Serbia/	
India	Montenegro	
Indonesia	Singapore	
Iran	Slovakia	

Weidmüller is the leading manufacturer of components for electrical connection technology. The Weidmüller product portfolio ranges from terminal blocks, PCB connectors and terminals, protected components, Industrial Ethernet components and relay sockets to power supply and overvoltage protection modules suitable for all applications. Electrical installation and marking material, basic I/O components and a variety of tools round off the range. As an OEM supplier, the company sets global standards in the field of electrical connection technology.

Toronto

W Interconnections Canada Inc
10 Spy Court
Markham, ON L3R 5H6
Tel (905) 475-1507, (800) 268-4080
Fax (905) 475-2798
info1@weidmuller.ca
www.weidmuller.ca

Montréal

W Interconnections Canada Inc
1800 boul. Le Corbusier, Suite 100
Chomedey, Laval, QC H7S 2K1
Tel (450) 687-9030, (800) 361-9694
Fax (450) 687-9038

Order Number:

99990345/10/2006

Printed in Canada