

MK Powersink

Single sided heatsink. See type MB for similar heat sink featuring tee-slots. See page 45 for pre-drilled standards. Finish: Black anodised.

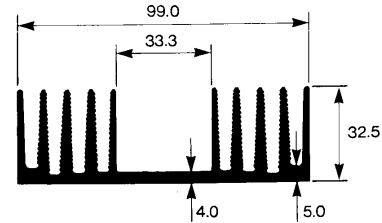
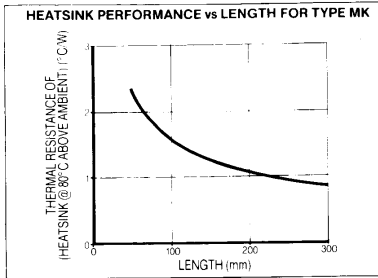
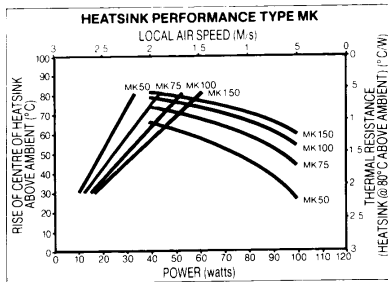

| Pattern No. | Length mm. | Thermal Rating $\Theta = ^\circ\text{C/W}$ |
|-------------|------------|--|
| MK50-1 | 50 | 2.4 |
| MK75-1 | 75 | 1.8 |
| MK100-1 | 100 | 1.5 |
| MK150-1 | 150 | 1.3 |

NV Powersink

Robust power handling heatsink featuring tee-slots and tie bar slots for easy tiering, stacking and electrical connections.

Finish: Black anodised.

See 920 series fan cooled units using NV heatsink.

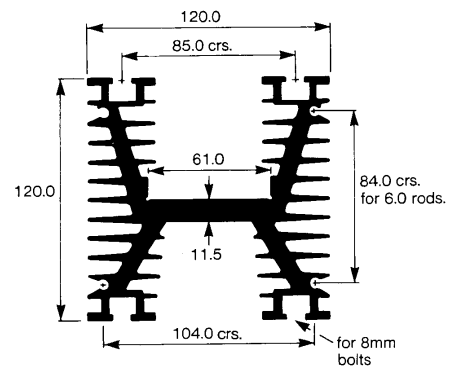
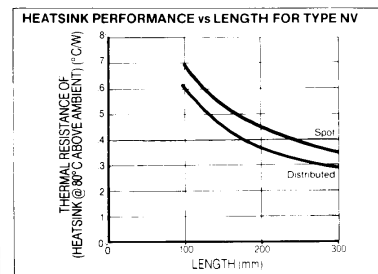
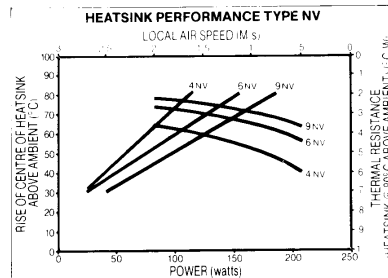

| Pattern No. | Length ins. | Length mm. | Thermal Rating $\Theta = ^\circ\text{C/W}$ Spot | Thermal Rating $\Theta = ^\circ\text{C/W}$ Distributed |
|-------------|-------------|------------|---|--|
| 4NV-1 | 4 | 101.6 | .70 | .61 |
| 6NV-1 | 6 | 152.4 | .51 | .45 |
| 9NV-1 | 9 | 228.6 | .43 | .37 |

NT Powersink

Finish: Black anodised.

Custom lengths available to order.

See also 980 series Fan cooled units.

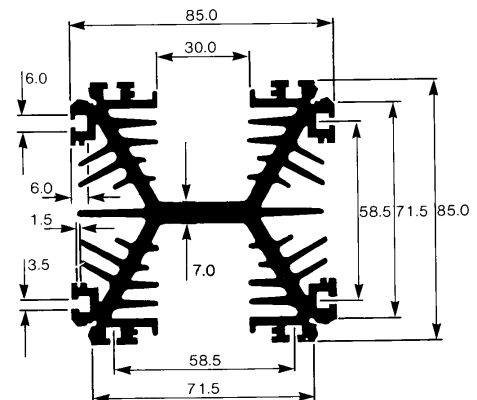
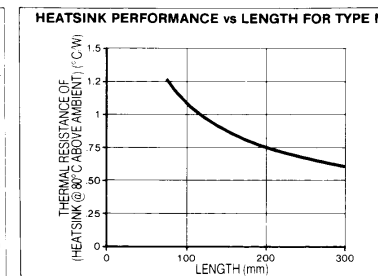
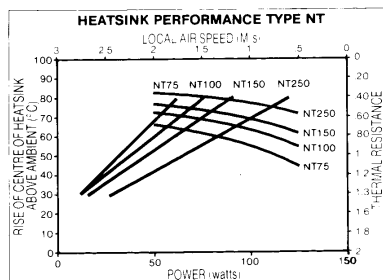

| Part No. | Length mm | Thermal Rating $\Theta = ^\circ\text{C/W}$ |
|----------|-----------|--|
| NT75-1 | 75 | 1.3 |
| NT100-1 | 100 | 1.1 |
| NT150-1 | 150 | 0.9 |
| NT250-1 | 250 | 0.7 |