

500 SERIES

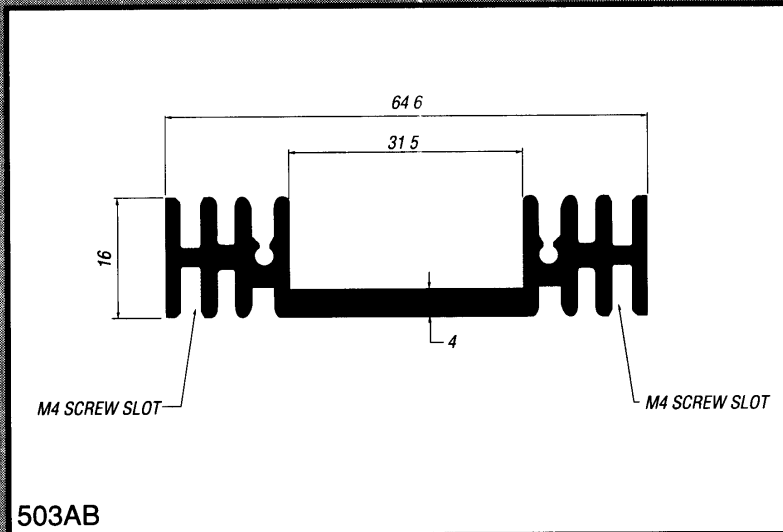

Typical Performance		°k/w Black				
Length		50	75	100	150	200
°k/w		5.50	4.50	3.80	3.00	2.50

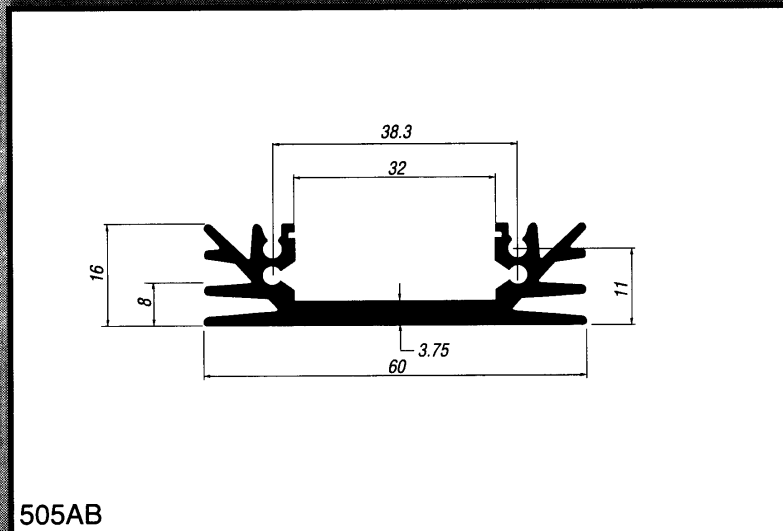
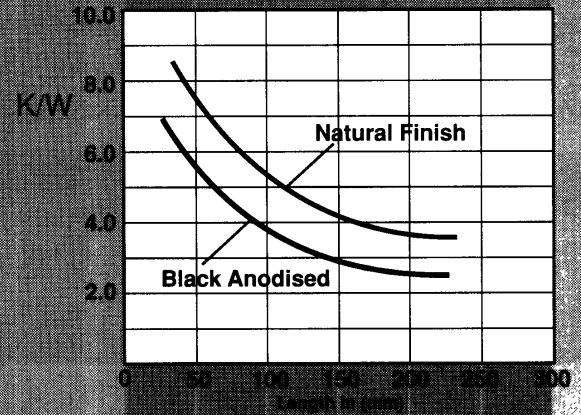

Typical Performance		°k/w Black				
Length		50	75	100	150	200
°k/w		5.00	3.70	3.00	2.30	2.10

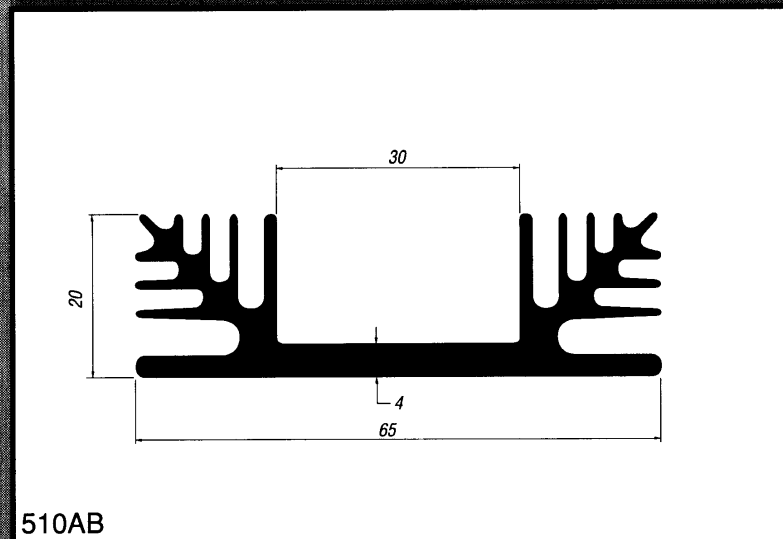
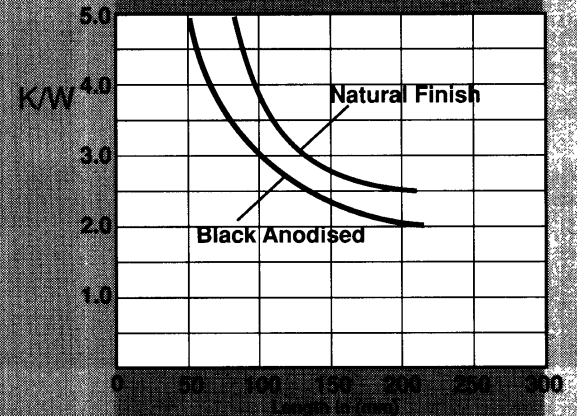

Typical Performance		°k/w Black				
Length		50	75	100	150	200
°k/w		3.30	2.65	2.30	1.80	1.65

