

## BOARD LEVEL POWER SEMICONDUCTOR HEAT SINKS

### 217 SERIES Surface Mount Heat Sinks

D<sup>2</sup>PAK, TO-220, SOT-223, SOL-20

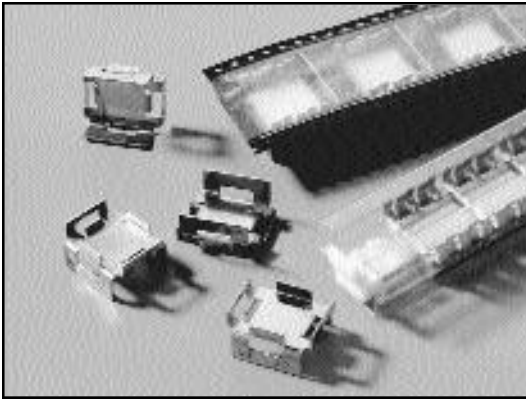

Compatible with surface mount technology (SMT) automated production techniques for ease of assembly and a variety of soldering methods, these heat sinks allow greater packaging densities and reduction in PC-board area, increasing the power dissipation of surface mount devices (SMDs) while maintaining and improving manufacturers' component thermal specifications.

#### FEATURES AND BENEFITS:

- No interface material is needed
- Copper with tin-lead plating for improved solderability and assembly
- Both the component and the heat sink are installed on the PC-board utilizing standard SMT assembly equipment for "Tape & Reel" and "Tube" formats
- EIA standards and ESD protection are specified
- Can be used with water soluble or no clean SMT solder creams or other pastes

Standard P/N	Height Above PC Board in. (mm)	Footprint Dimensions in. (mm)	Package Format	Package Quantity	Thermal Performance at Typical Load	
					Natural Convection	Forced Convection
217-36CT6 ▲	.390 (9.9)	.600 (15.2) x .740 (18.8)	Bulk	1	55°C @ 1W	16.0°C/W @ 200 LFM
217-36CTT6	.390 (9.9)	.600 (15.2) x .740 (18.8)	Tube	20	55°C @ 1W	16.0°C/W @ 200 LFM
217-36CTR6▲	.390 (9.9)	.600 (15.2) x .740 (18.8)	Tape & Reel	250	55°C @ 1W	16.0°C/W @ 200 LFM

Material: Copper, Tin, Lead Plated

#### MECHANICAL DIMENSIONS

#### 217 HEAT SINK WITH DDPAK DEVICE

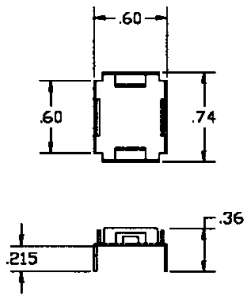

217-36CT6

#### THERMAL PERFORMANCE 6 LAYER BOARD, D<sup>2</sup>PAK 125°C LEAD, 40°C AMBIENT

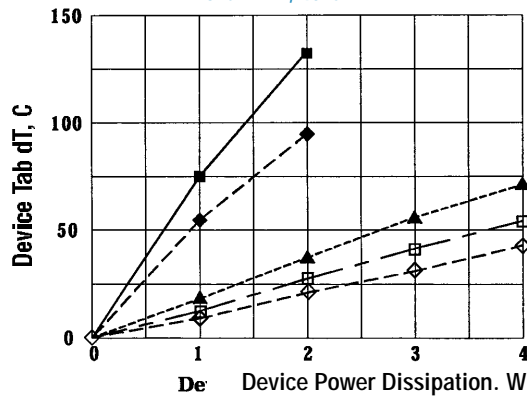

KEY: ■ Device only, NC ◆ Device + HS, NC ▲ Device + HS, 100 lfm □ Device + HS, 200 lfm ◇ Device + HS, 300 lfm

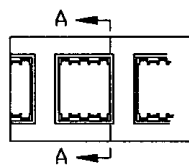

SECTION A-A

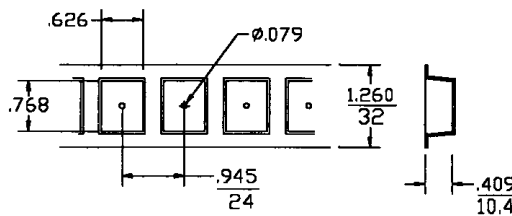

TAPE DETAILS



REEL DETAILS

- NOTES
1. Material to be "ESD"
  2. Approximately 6 Meters per Reel
  3. 250 Pieces per Reel.

217-36CTR6

Dimensions: in.

# BOARD LEVEL POWER SEMICONDUCTOR HEAT SINKS

217 SERIES Surface Mount Heat Sinks

D<sup>2</sup>PAK, TO-220, SOL-20

### MECHANICAL DIMENSIONS

#### 217 SERIES

#### TUBE DETAILS

TUBE: 16.25 Inches Long, Min. ESD Material with Nail Stops  
20 Pieces per Tube

217-36CTT6

### BOARD LAYOUT RECOMMENDATIONS

REF: JEDEC TO-220AB  
SOLDER MASK OPENING

REF: JEDEC TO-263 (DD PAK)  
REF: JEDEC MO-169 (DD PAK)

SOL 20

217-36CT6

Dimensions: in.

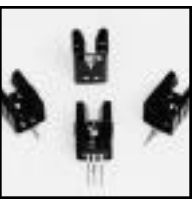

### 230 AND 234 SERIES Compact, Wavesolderable Low-Profile Self-Locking Heat Sinks

TO-220

Standard P/N	Height Above PC Board in. (mm)	Footprint Dimensions in. (mm)	Mounting Configuration	Solderable Tab Option	Mounting Style	Thermal Performance at Typical Load	
						Natural Convection	Forced Convection
230-75AB ▲	.750 (19.1)	.570 (14.5) x .500 (12.7)	Vert./Horiz.	No Tab	Clip/Mtg Hole	57°C @ 2W	7.5°C/W @ 400 LFM
230-75AB-01	.750 (19.1)	.570 (14.5) x .500 (12.7)	Vertical	01	Clip/Mtg Hole	57°C @ 2W	7.5°C/W @ 400 LFM
230-75AB-05	.500 (12.7)	.750 (19.1) x .570 (14.5)	Horizontal	05	Clip/Mtg Hole	57°C @ 2W	7.5°C/W @ 400 LFM
230-75AB-10	.875 (22.2)	.570 (14.5) x .500 (12.7)	Vertical	10	Clip/Mtg Hole	57°C @ 2W	7.5°C/W @ 400 LFM
234-75AB	.790 (20.0)	.570 (14.5) x .500 (12.7)	Vert./Horiz.	No Tab	Clip/Mtg Hole	57°C @ 2W	7.5°C/W @ 400 LFM
234-75AB-01	.790 (20.0)	.570 (14.5) x .500 (12.7)	Vertical	01	Clip/Mtg Hole	57°C @ 2W	7.5°C/W @ 400 LFM
234-75AB-05	.500 (12.7)	.790 (20.0) x .570 (14.5)	Horizontal	05	Clip/Mtg Hole	57°C @ 2W	7.5°C/W @ 400 LFM

Material: Aluminum, Black Anodized

### MECHANICAL DIMENSIONS

234 SERIES

234-75AB

234-75AB-01

234-75AB-05

### 230 SERIES

SUGGESTED TAB HOLE= ø.075 (1.9) (PLATED) WITH ø.100 (2.5) PAD

#### NATURAL AND FORCED CONVECTION CHARACTERISTICS

AIR VELOCITY (LFM)

HEAT SINK TEMPERATURE RISE ABOVE AMBIENT AIR (°C)

POWER DISSIPATION (WATTS)

THERMAL RESISTANCE SINK TO AMBIENT (°C/WATT)

Dimensions: in. (mm)

▲ Normally stocked

## BOARD LEVEL POWER SEMICONDUCTOR HEAT SINKS



### 233 AND 236 SERIES Self-Locking Wavesolderable Heat Sinks

TO-220

Standard P/N	Height Above PC Board in. (mm)	Footprint Dimensions in. (mm)	Mounting Configuration	Solderable Tab Options	Mounting Style	Thermal Performance at Typical Load	
						Natural Convection	Forced Convection
233-60AB ▲	.600 (15.2)	.570 (14.5) x .500 (12.7)	Vert./Horiz.	No Tab	Clip/Mtg Hole	58°C @ 2W	11.0°C/W @ 400 LFM
233-60AB-01	.600 (15.2)	.570 (14.5) x .500 (12.7)	Vertical	01	Clip/Mtg Hole	58°C @ 2W	11.0°C/W @ 400 LFM
233-60AB-05	.500 (12.7)	.600 (15.2) x .570 (14.5)	Horizontal	05	Clip/Mtg Hole	58°C @ 2W	11.0°C/W @ 400 LFM
233-60AB-10 ▲	.725 (18.4)	.570 (14.5) x .500 (12.7)	Vertical	10	Clip/Mtg Hole	58°C @ 2W	11.0°C/W @ 400 LFM
236-150AB	1.500 (38.1)	.570 (14.5) x .500 (12.7)	Vert./Horiz.	No Tab	Clip/Mtg Hole	58°C @ 2W	4.80°C/W @ 400 LFM
236-150AB-01	1.500 (38.1)	.570 (14.5) x .500 (12.7)	Vertical	01	Clip/Mtg Hole	58°C @ 2W	4.80°C/W @ 400 LFM
236-150AB-05 ▲	.500 (12.7)	1.500 (38.1) x .570 (14.5)	Horizontal	05	Clip/Mtg Hole	58°C @ 2W	4.80°C/W @ 400 LFM
236-150AB-10	1.625 (41.3)	.570 (14.5) x .570 (12.7)	Vertical	10	Clip/Mtg Hole	58°C @ 2W	4.80°C/W @ 400 LFM

Material: Aluminum, Black Anodized

#### MECHANICAL DIMENSIONS 233 AND 236 SERIES

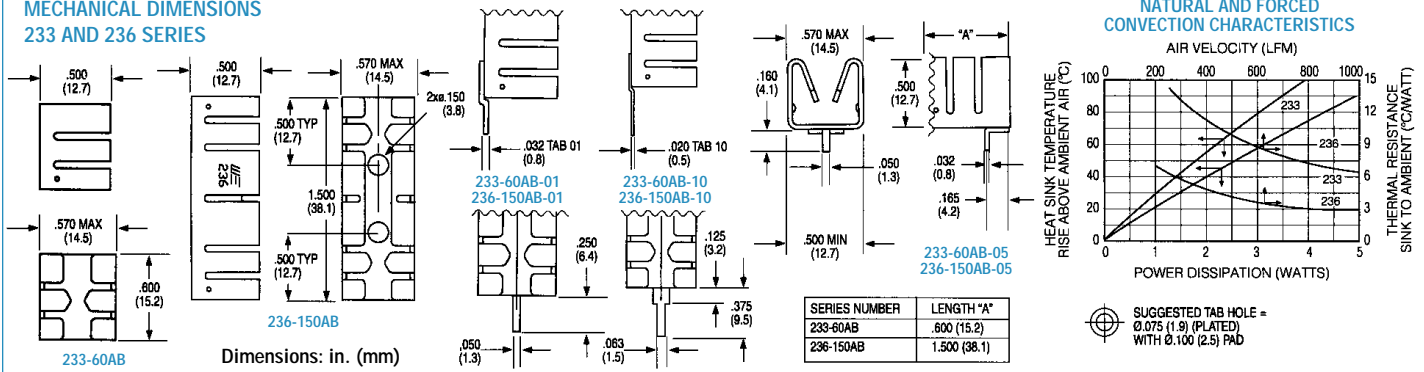

### 275 AND 231 SERIES Compact, Stress-Free Labor-Saving Locking-Tab Heat Sinks

TO-220

Standard P/N	Height Above PC Board in. (mm)	Footprint Dimensions in. (mm)	Mounting Configuration	Solderable Tab Options	Mounting Style	Thermal Performance at Typical Load	
						Natural Convection	Forced Convection
275-75AB	.750 (19.1)	.835 (21.2) x .400 (10.2)	Vert./Horiz.	No Tab	Clip/Mtg Hole	44°C @ 2W	7.9°C/W @ 400 LFM
275-75AB-01	.750 (19.1)	.835 (21.2) x .400 (10.2)	Vertical	01	Clip/Mtg Hole	44°C @ 2W	7.9°C/W @ 400 LFM
275-75AB-10	.875 (12.7)	.835 (21.2) x .400 (14.5)	Vertical	10	Clip/Mtg Hole	44°C @ 2W	7.9°C/W @ 400 LFM
231-69PAB	.690 (18.4)	.835 (21.2) x .400 (12.7)	Vert./Horiz.	No Tab	Clip/Mtg Hole	45°C @ 2W	8°C/W @ 400 LFM
231-69PAB-13H	.400 (38.1)	.690 (17.5) x .835 (12.7)	Horizontal	13H	Clip/Mtg Hole	45°C @ 2W	8°C/W @ 400 LFM
231-69PAB-XXX	.690 (38.1)	.835 (21.2) x .400 (12.7)	Vertical	13V, 14V, 15V	Clip/Mtg Hole	45°C @ 2W	8°C/W @ 400 LFM
231-75PAB	.750 (12.7)	.835 (21.2) x .400 (14.5)	Vert./Horiz.	No Tab	Clip/Mtg Hole	43°C @ 2W	7.9°C/W @ 400 LFM
231-75PAB-13H	.400 (41.3)	.750 (19.1) x .835 (12.7)	Horizontal	13H	Clip/Mtg Hole	43°C @ 2W	7.9°C/W @ 400 LFM
(14V) ▲ 231-75PAB-XXX	.750 (34.9)	.835 (21.2) x .400 (12.7)	Vertical	13V, 14V, 15V	Clip/Mtg Hole	43°C @ 2W	7.9°C/W @ 400 LFM
231-137PAB	1.375 (10.2)	.835 (21.2) x .400 (12.7)	Vert./Horiz.	No Tab	Clip/Mtg Hole	32°C @ 2W	5.9°C/W @ 400 LFM
231-137PAB-13H	.400 (10.2)	1.375 (34.9) x .835 (12.7)	Horizontal	13H	Clip/Mtg Hole	32°C @ 2W	5.9°C/W @ 400 LFM
(15V) ▲ 231-137PAB-XXX	1.375 (10.2)	.835 (21.2) x .400 (12.7)	Vertical	13V, 14V, 15V	Clip/Mtg Hole	32°C @ 2W	5.9°C/W @ 400 LFM

Material: Aluminum, Pre-anodized Black (PAB), Anodized Black (AB)

#### MECHANICAL DIMENSIONS

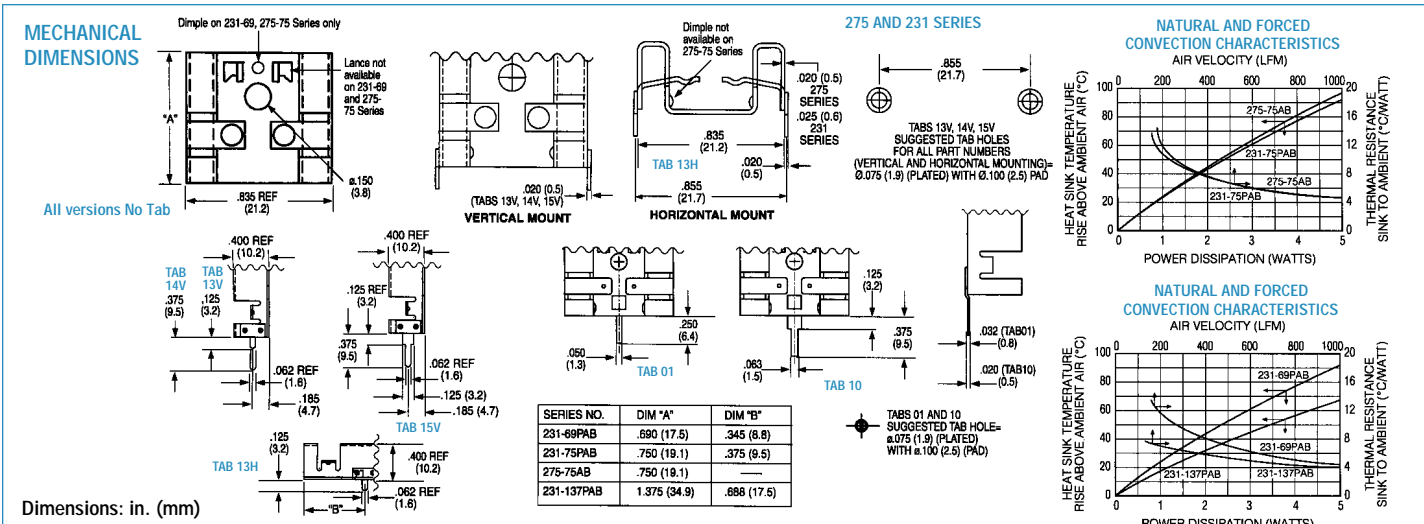

## BOARD LEVEL POWER SEMICONDUCTOR HEAT SINKS



PATENT 5381041

### 235 SERIES Compact, Stress-Free Labor-Saving Locking-Tab Heat Sinks

TO-220

Standard P/N	Height Above PC Board in. (mm)	Footprint Dimensions in. (mm)	Mounting Configuration	Solderable Tab Options	Mounting Style	Thermal Performance at Typical Load	
						Natural Convection	Forced Convection
235-85AB ▲	.850 (21.6)	1.000 (25.4) x .500 (12.7)	Vert./Horiz.	No Tab	Clip/Mtg Hole	40°C @ 2W	6.8°C/W @ 400 LFM
235-85AB-01	.850 (21.6)	1.000 (25.4) x .500 (12.7)	Vertical	01	Clip/Mtg Hole	40°C @ 2W	6.8°C/W @ 400 LFM
235-85AB-05	.500 (12.7)	.850 (21.6) x 1.000 (25.4)	Horizontal	05	Clip/Mtg Hole	40°C @ 2W	6.8°C/W @ 400 LFM
235-85AB-10	.975 (24.8)	1.000 (25.4) x .500 (12.7)	Vertical	10	Clip/Mtg Hole	40°C @ 2W	6.8°C/W @ 400 LFM

Material: Aluminum, Black Anodized

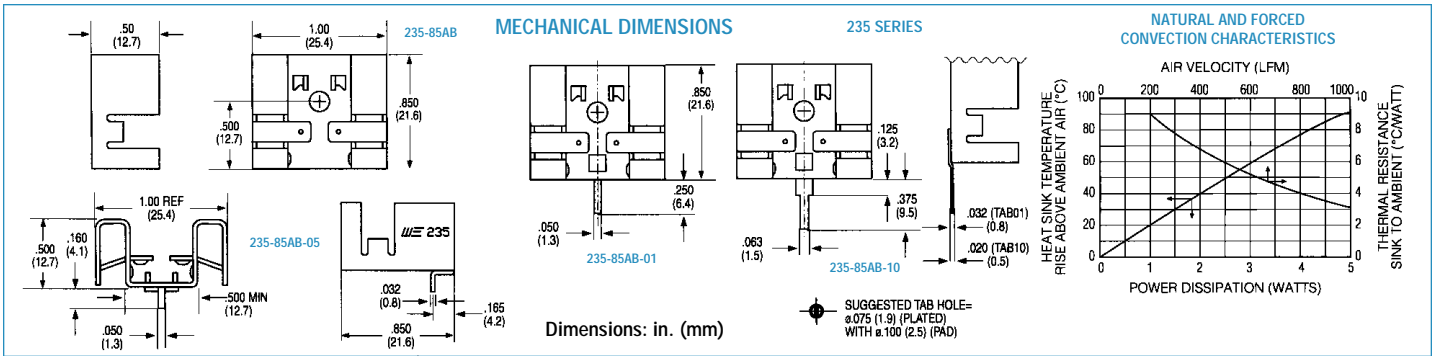

### 243 SERIES Labor-Saving Clip-On Heat Sinks

TO-220

Standard P/N	Height Above PC Board in. (mm)	Footprint Dimensions in. (mm)	Mounting Configuration	Solderable Tab Options	Mounting Style	Thermal Performance at Typical Load	
						Natural Convection	Forced Convection
243-1PAB	1.000 (25.4)	.800 (20.3) x .270 (6.9)	Vert./Horiz.	No Tab	Clip	50°C @ 2W	4.5°C/W @ 400 LFM
243-3PAB ▲	.800 (20.3)	.800 (20.3) x .270 (6.9)	Vert./Horiz.	No Tab	Clip	78°C @ 2W	8.2°C/W @ 400 LFM

Material: Aluminum, Pre-anodized Black

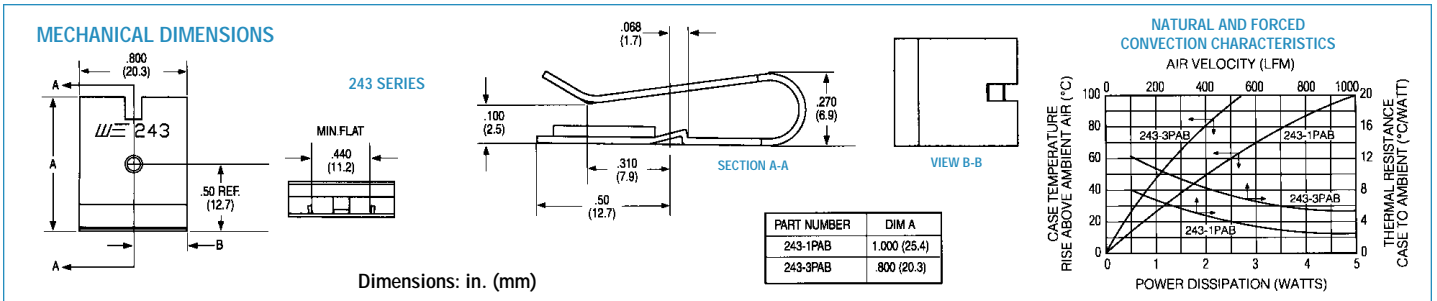

PATENT PENDING

### 239 SERIES Snap-Down Self-Locking Heat Sinks

TO-220

Standard P/N	Height Above PC Board in. (mm)	Footprint Dimensions in. (mm)	Mounting Configuration	Solderable Tab Options	Mounting Style	Thermal Performance at Typical Load	
						Natural Convection	Forced Convection
239-75AB	.750 (19.1)	1.120 (28.4) x .435 (11.0)	Vert./Horiz.	No Tab	Clip/Mtg Hole	38°C @ 2W	6°C/W @ 400 LFM
239-75AB-03	.750 (19.1)	1.120 (28.4) x .435 (11.0)	Vertical	03	Clip/Mtg Hole	38°C @ 2W	6°C/W @ 400 LFM
239-75AB-04	.750 (19.1)	1.120 (28.4) x .435 (11.0)	Vertical	04	Clip/Mtg Hole	38°C @ 2W	6°C/W @ 400 LFM

Material: Aluminum, Black Anodized

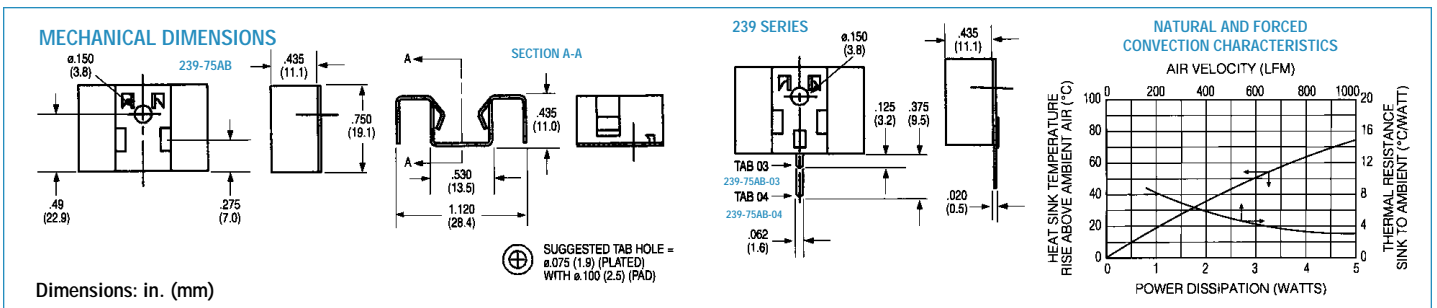

## BOARD LEVEL POWER SEMICONDUCTOR HEAT SINKS



### 273 SERIES Low-Cost, Low-Height Wavesolderable Heat Sinks

TO-218, TO-220

Standard P/N	Height Above PC Board in. (mm)	Footprint Dimensions in. (mm)	Mounting Configuration	Solderable Tab Options	Mounting Style	Thermal Performance at Typical Load	
						Natural Convection	Forced Convection
273-AB ▲	.375 (9.5)	.750 (19.1) x .750 (19.1)	Vert./Horiz.	No Tab	Mtg Hole	49°C @ 2W	7.2°C/W @ 400 LFM
273-AB-01	.375 (9.5)	.750 (19.1) x .750 (19.1)	Vertical	01	Mtg Hole	49°C @ 2W	7.2°C/W @ 400 LFM
273-AB-02	.375 (9.5)	.750 (19.1) x .750 (19.1)	Vertical	02	Mtg Hole	49°C @ 2W	7.2°C/W @ 400 LFM

Material: Aluminum, Black Anodized

#### MECHANICAL DIMENSIONS

#### 273 SERIES

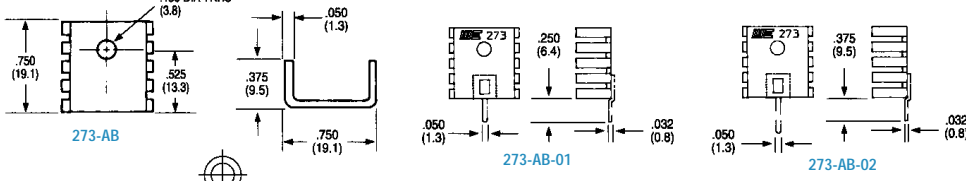

Note: 1. Suggested Tab Hole =  $\phi$ .075 (1.9) (Plated) with  $\phi$ .100 (2.5) pad

Dimensions: in. (mm)

#### NATURAL AND FORCED CONVECTION CHARACTERISTICS

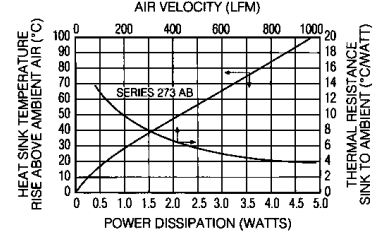

### 274 SERIES Low-Cost, Low-Height Wavesolderable Heat Sinks

TO-220

Standard P/N	Height Above PC Board in. (mm)	Footprint Dimensions in. (mm)	Mounting Configuration	Solderable Tab Options	Mounting Style	Thermal Performance at Typical Load	
						Natural Convection	Forced Convection
274-1AB ▲	.375 (9.5)	.520 (13.2) x .750 (19.1)	Vert./Horiz.	No Tab	Mtg Hole	56°C @ 2W	8.0°C/W @ 400 LFM
274-1AB-01 ▲	.375 (9.5)	.520 (13.2) x .750 (19.1)	Vertical	01	Mtg Hole	56°C @ 2W	8.0°C/W @ 400 LFM
274-1AB-02 ▲	.375 (9.5)	.520 (13.2) x .750 (19.1)	Vertical	02	Mtg Hole	56°C @ 2W	8.0°C/W @ 400 LFM
274-2AB ▲	.500 (12.7)	.520 (13.2) x .750 (19.1)	Vert./Horiz.	No Tab	Mtg Hole	50°C @ 2W	7.0°C/W @ 400 LFM
274-2AB-01	.500 (12.7)	.520 (13.2) x .750 (19.1)	Vertical	01	Mtg Hole	50°C @ 2W	7.0°C/W @ 400 LFM
274-2AB-02	.500 (12.7)	.520 (13.2) x .750 (19.1)	Vertical	02	Mtg Hole	50°C @ 2W	7.0°C/W @ 400 LFM
274-3AB ▲	.250 (6.4)	.520 (13.2) x .750 (19.1)	Vert./Horiz.	No Tab	Mtg Hole	62°C @ 2W	9.0°C/W @ 400 LFM
274-3AB-01	.250 (6.4)	.520 (13.2) x .750 (19.1)	Vertical	01	Mtg Hole	62°C @ 2W	9.0°C/W @ 400 LFM
274-3AB-02	.250 (6.4)	.520 (13.2) x .750 (19.1)	Vertical	02	Mtg Hole	62°C @ 2W	9.0°C/W @ 400 LFM
281-1AB	.375 (9.5)	.520 (13.2) x .750 (19.1)	Vertical	No Tab	Mtg Hole	56°C @ 2W	8.0°C/W @ 400 LFM
281-2AB	.500 (12.7)	.520 (13.2) x .750 (19.1)	Vertical	No Tab	Mtg Hole	50°C @ 2W	7.0°C/W @ 400 LFM

Material: Aluminum, Black Anodized

#### MECHANICAL DIMENSIONS

#### 274 SERIES

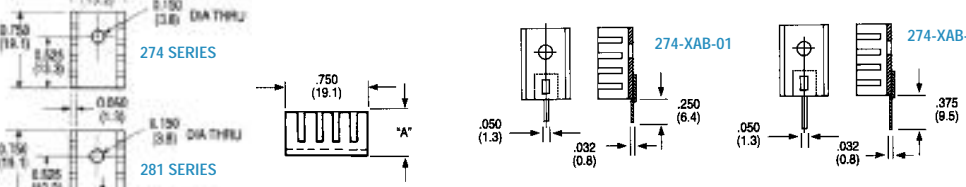

Dimensions: in. (mm)

0.075 (1.9) (plated) 0.100 (2.5) pad  
PCB recommended hole/pad size

#### NATURAL AND FORCED CONVECTION CHARACTERISTICS

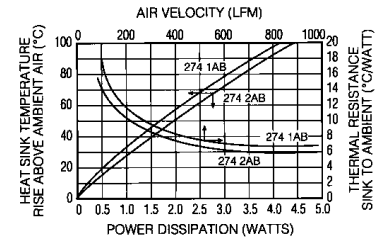

### 240 SERIES Labor-Saving Twisted Fin Heat Sinks

TO-220

Standard P/N	Height Above PC Board in. (mm)	Footprint Dimensions in. (mm)	Mounting Configuration	Solderable Tab Options	Mounting Style	Thermal Performance at Typical Load	
						Natural Convection	Forced Convection
240-118ABH-22 ▲	1.180 (30.0)	1.000 (25.4) x .500 (12.7)	Vertical	22	Clip/Mtg Hole	55°C @ 4W	5.3°C/W @ 400 LFM
240-118ABS-22	1.180 (30.0)	1.000 (25.4) x .500 (12.7)	Vertical	22	Clip/Mtg Slot	55°C @ 4W	5.3°C/W @ 400 LFM

Material: Aluminum, Black Anodized

#### MECHANICAL DIMENSIONS

#### 240 SERIES

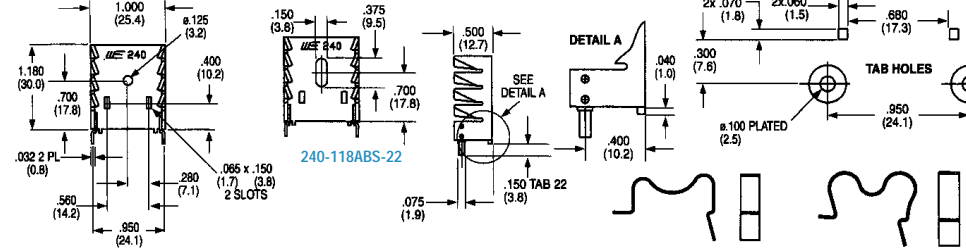

Dimensions: in. (mm)

STAINLESS STEEL 330SC 4# SPRING STEEL 285SC 10#  
Order SpeedClips™ Separately

#### NATURAL AND FORCED CONVECTION CHARACTERISTICS

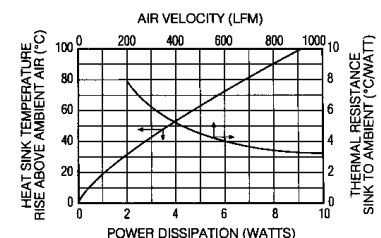

## BOARD LEVEL POWER SEMICONDUCTOR HEAT SINKS

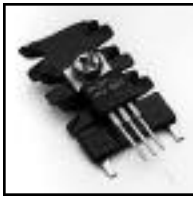

### 242 SERIES Low-Height, Low-Profile Twisted Fin Heat Sinks

TO-220

Standard P/N	Height Above PC Board in. (mm)	Footprint Dimensions in. (mm)	Mounting Configuration	Solderable Tab Options	Mounting Style	Thermal Performance at Typical Load	
						Natural Convection	Forced Convection
242-125AB-22	1.285 (32.6)	.875 (22.2) x .250 (6.4)	Vertical	22	Mtg Hole	48°C @ 2W	6.2°C/W @ 400 LFM

Material: Aluminum, Black Anodized

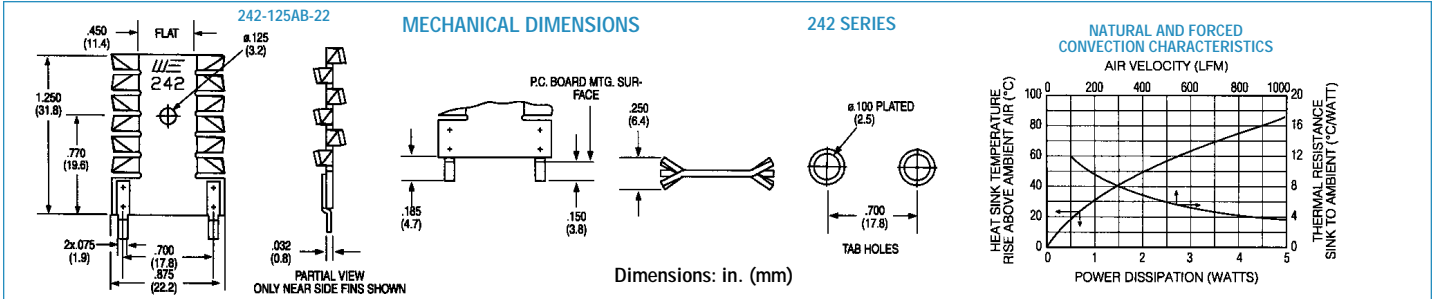

### 232 AND 238 SERIES Staggered Fin Heat Sinks for Vertical Mounting

TO-202, TO-220

Standard P/N	Height Above PC Board in. (mm)	Footprint Dimensions in. (mm)	Mounting Configuration	Solderable Tab Options	Mounting Style	Thermal Performance at Typical Load	
						Natural Convection	Forced Convection
232-200AB	2.000 (50.8)	1.380 (35.1) x .500 (12.7)	Vertical	2, Twisted	Clip/Mtg Hole	48°C @ 4W	3.3°C/W @ 400 LFM
232-200AB-23	2.000 (50.8)	1.380 (35.1) x .500 (12.7)	Vertical	2, Solderable	Clip/Mtg Hole	48°C @ 4W	3.3°C/W @ 400 LFM
238-200AB	2.000 (50.8)	1.380 (35.1) x .500 (12.7)	Vertical	2, Twisted	Mtg Slot	48°C @ 4W	3.3°C/W @ 400 LFM
238-200AB-23	2.000 (50.8)	1.380 (35.1) x .500 (12.7)	Vertical	2, Solderable	Mtg Slot	48°C @ 4W	3.3°C/W @ 400 LFM

Material: Aluminum, Black Anodized

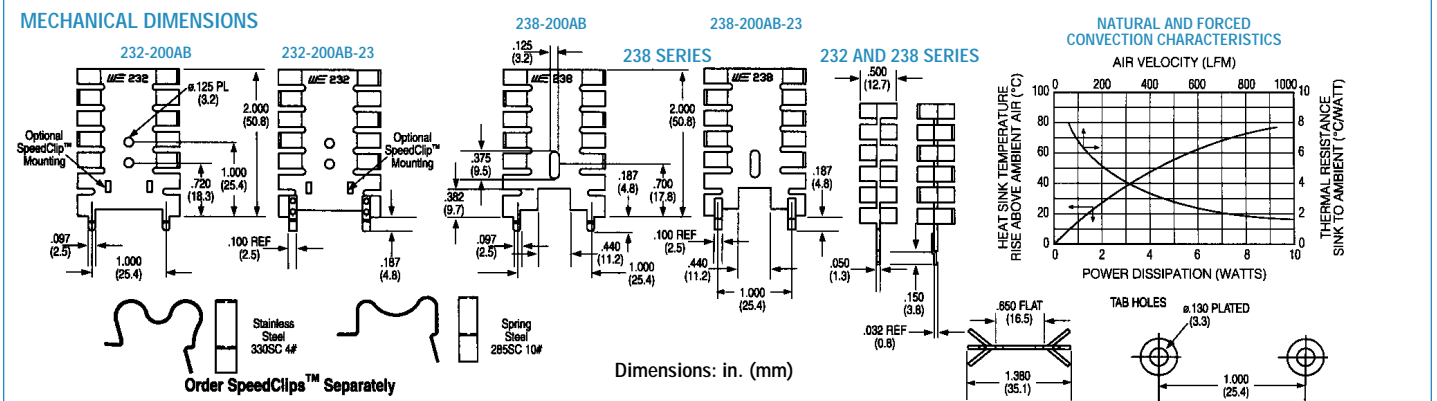

### 251 SERIES Slim-Profile Heat Sinks With Integral Clips

15 Lead Multiwatt

Standard P/N	Height Above PC Board in. (mm)	Footprint Dimensions in. (mm)	Mounting Configuration	Solderable Tab Options	Mounting Style	Thermal Performance at Typical Load	
						Natural Convection	Forced Convection
251-62AB	.620 (15.7)	.910 (23.1) x .380 (9.7)	Vert./Horiz.	No Tab	Clip	66°C @ 3W	66°C/W @ 400 LFM
251-80AB	.845 (21.5)	.910 (23.1) x .380 (9.7)	Vert./Horiz.	No Tab	Clip	64°C @ 3W	66°C/W @ 400 LFM
251-80AB-19	.875 (22.2)	.910 (23.1) x .380 (9.7)	Vertical	19	Clip	64°C @ 3W	66°C/W @ 400 LFM

Material: Aluminum, Black Anodized

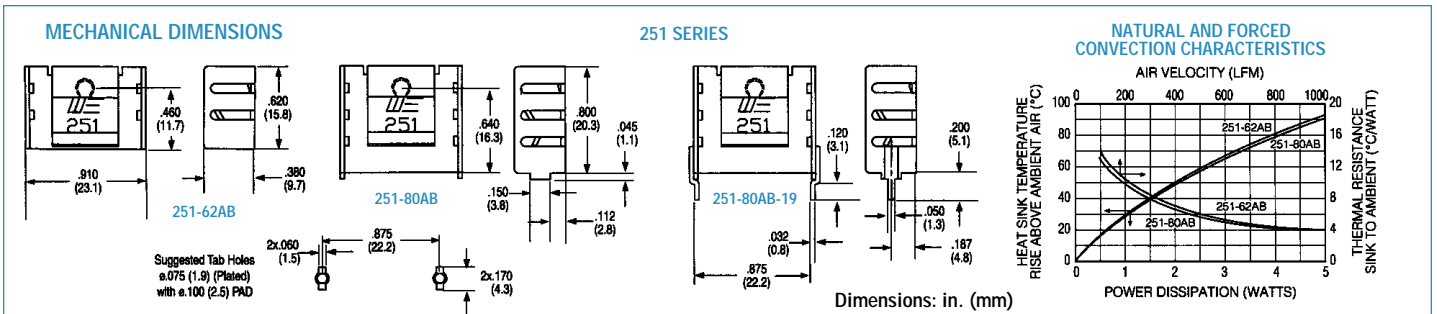

## BOARD LEVEL HEAT SINKS FOR TO-220, TO-218 AND MULTIWATT™ COMPONENTS



**244 SERIES** *Low Height, Slim Profile Wavesolderable Folded Fin Heat Sinks*

MULTIWATT

Standard P/N	Height Above PC Board in. (mm)	Footprint Dimensions in. (mm)	Mounting Configuration	Solderable Tab Options	Thermal Performance at Typical Load		Weight lbs. (grams)
					Natural Convection	Forced Convection	
244-145AB	1.450 (36.8)	1.300 (33.0) x 480 (12.1)	Vert./Horiz.	No Tab	44°C @ 4W	4.4°C/W @ 400 LFM	.0160 (7.25)
244-145AB-50	1.650 (41.9)	1.300 (33.0) x 480 (12.1)	Vertical	50	44°C @ 4W	4.4°C/W @ 400 LFM	.0170 (7.20)

Material: Aluminum, Black Anodized

### MECHANICAL DIMENSIONS

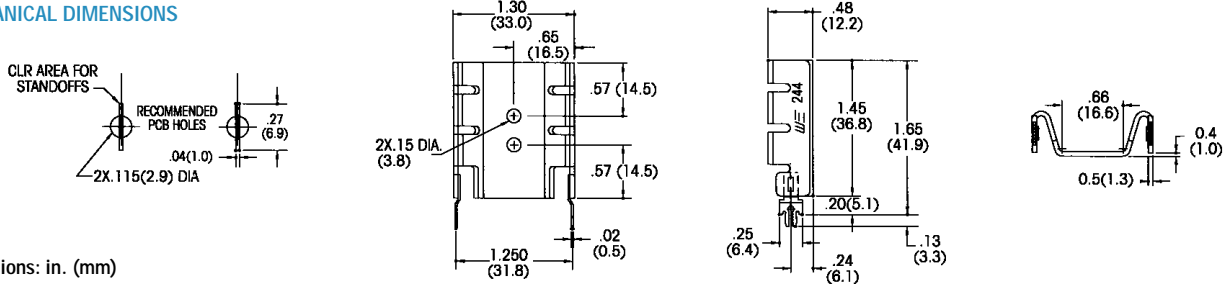

Dimensions: in. (mm)



**245 SERIES** *Low Height, Slim Profile Wavesolderable Folded Fin Heat Sinks*

MULTIWATT

Standard P/N	Height Above PC Board in. (mm)	Footprint Dimensions in. (mm)	Mounting Configuration	Solderable Tab Options	Thermal Performance at Typical Load		Weight lbs. (grams)
					Natural Convection	Forced Convection	
245-145AB	1.450 (36.8)	1.750 (44.5) x .380 (9.7)	Vert./Horiz.	No Tab	38°C @ 4W	3.2°C/W @ 400 LFM	.0160 (7.25)
245-145AB-50	1.650 (41.9)	1.750 (44.5) x .380 (9.7)	Vertical	50	38°C @ 4W	3.2°C/W @ 400 LFM	.0170 (7.20)

Material: Aluminum, Black Anodized

### MECHANICAL DIMENSIONS

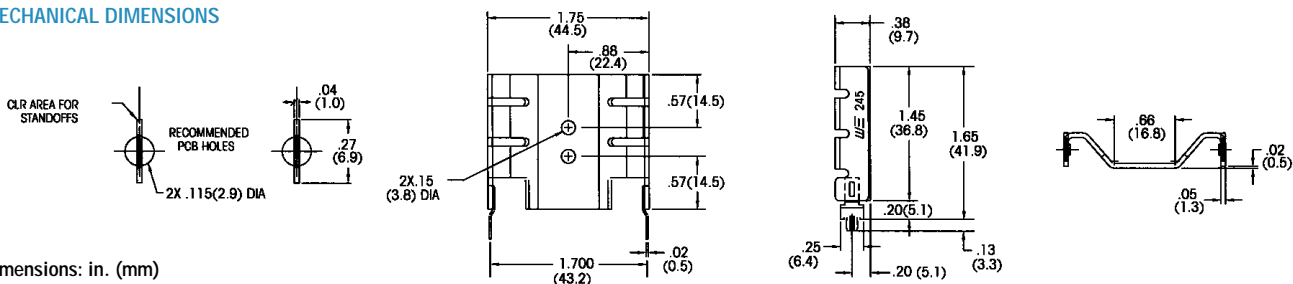

Dimensions: in. (mm)



**246 SERIES** *Medium Height, Slim Profile Wavesolderable Folded Fin Heat Sinks*

MULTIWATT

Standard P/N	Height Above PC Board in. (mm)	Footprint Dimensions in. (mm)	Mounting Configuration	Solderable Tab Options	Thermal Performance at Typical Load		Weight lbs. (grams)
					Natural Convection	Forced Convection	
246-197AB	1.968 (50.0)	1.986 (50.4) x 3.75 (9.5)	Vert./Horiz.	No Tab	35°C @ 4W	2.8°C/W @ 400 LFM	.0240 (10.90)
246-197AB-50	2.168 (55.1)	1.986 (50.4) x 3.75 (9.5)	Vertical	50	35°C @ 4W	2.8°C/W @ 400 LFM	.0250 (11.40)

Order SpeedClip™ 285SC or 330SC separately. (See 248 Series section).  
Material: Aluminum, Black Anodized

### MECHANICAL DIMENSIONS

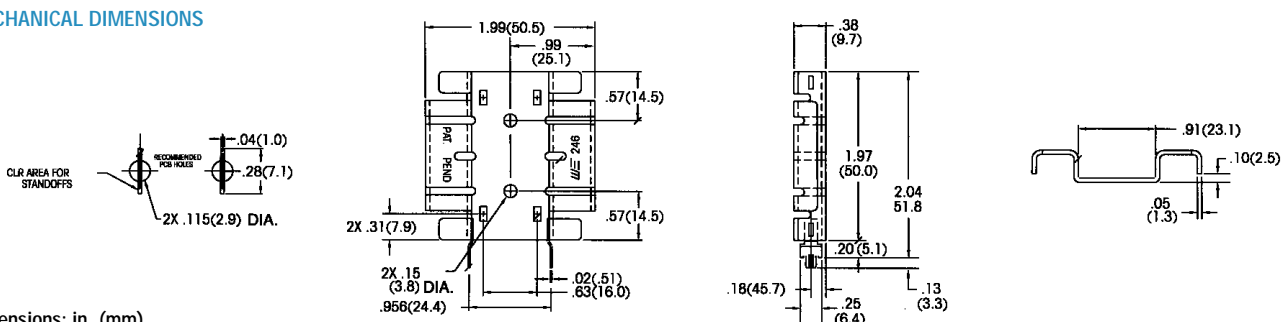

Dimensions: in. (mm)

## BOARD LEVEL HEAT SINKS FOR TO-220, TO-218 AND MULTIWATT™ COMPONENTS



**247 SERIES** Medium Height, Deep Profile Wavesolderable Folded Fin Heat Sinks

MULTIWATT

Standard P/N	Height Above PC Board in. (mm)	Footprint Dimensions in. (mm)	Mounting Configuration	Solderable Tab Options	Thermal Performance at Typical Load		Weight lbs. (grams)
					Natural Convection	Forced Convection	
247-195AB	1.950 (49.5)	1.900 (48.3) x .950 (24.1)	Vert./Horiz.	No Tab	25°C @ 4W	2.4°C/W @ 400 LFM	.0330 (15.10)
247-195AB-50	1.950 (49.5)	1.900 (48.3) x .950 (24.1)	Vertical	50	25°C @ 4W	2.4°C/W @ 400 LFM	.0340 (15.60)

Order SpeedClip™ 285SC or 330SC separately. (See 248 Series section).  
Material: Aluminum, Black Anodized

### MECHANICAL DIMENSIONS

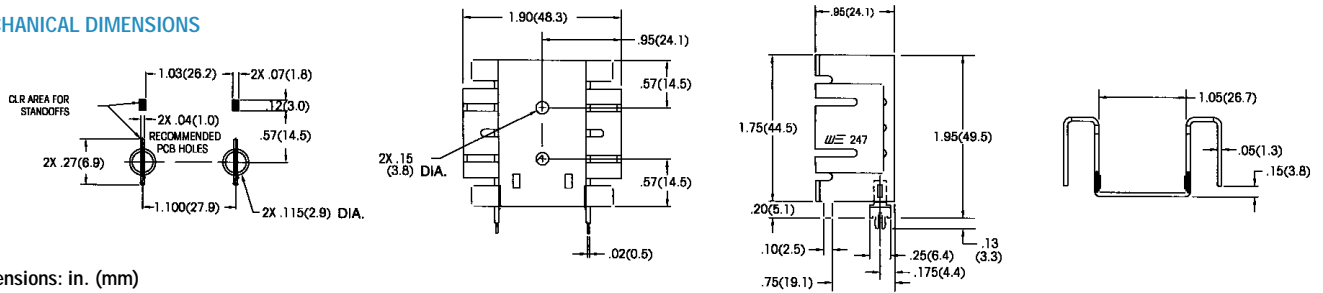

**248 SERIES** Low Height, Medium Profile Wavesolderable Folded Fin Heat Sinks

MULTIWATT

Standard P/N	Height Above PC Board in. (mm)	Footprint Dimensions in. (mm)	Mounting Configuration	Solderable Tab Options	Thermal Performance at Typical Load		Weight lbs. (grams)
					Natural Convection	Forced Convection	
248-162AB	1.620 (41.1)	2.000 (50.8) x .750 (19.1)	Vert./Horiz.	No Tab	35°C @ 4w	2.5°C/W @ 400 LFM	.026 (11.60)
248-162AB-50	1.620 (41.1)	2.000 (50.8) x .750 (19.1)	Vertical	50	35°C @ 4w	2.5°C/W @ 400 LFM	.027 (12.20)

Order SpeedClip™ 285SC or 330SC separately.  
Material: Aluminum, Black Anodized

### MECHANICAL DIMENSIONS

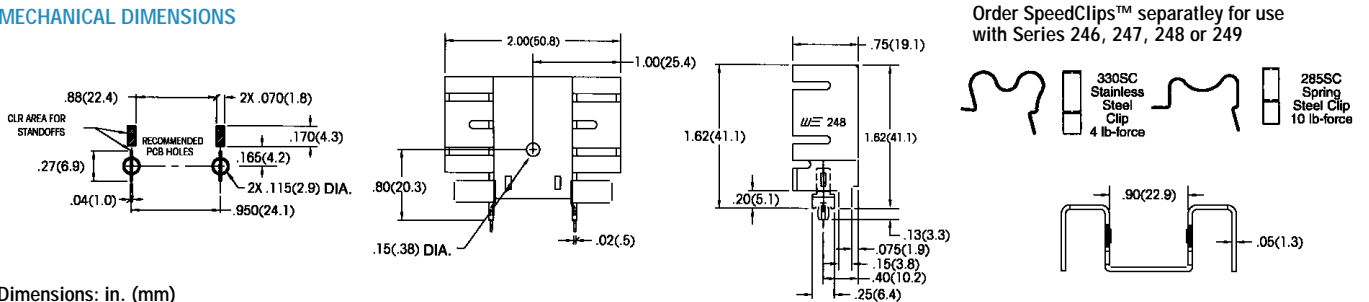

**249 SERIES** Medium Height, Deep Profile Wavesolderable Folded Fin Heat Sinks

MULTIWATT

Standard P/N	Height Above PC Board in. (mm)	Footprint Dimensions in. (mm)	Mounting Configuration	Solderable Tab Options	Thermal Performance at Typical Load		Weight lbs. (grams)
					Natural Convection	Forced Convection	
249-113AB	1.130 (28.7)	1.900 (48.3) x .950 (24.1)	Vert./Horiz.	No Tab	35°C @ 4W	3.29°C/W @ 400 LFM	.020 (8.90)
249-113AB-50	1.130 (28.7)	1.900 (48.3) x .950 (24.1)	Vertical	50	35°C @ 4W	3.29°C/W @ 400 LFM	.021 (9.40)

Order SpeedClip™ 285SC or 330SC separately. (See 248 Series section).  
Material: Aluminum, Black Anodized

### MECHANICAL DIMENSIONS

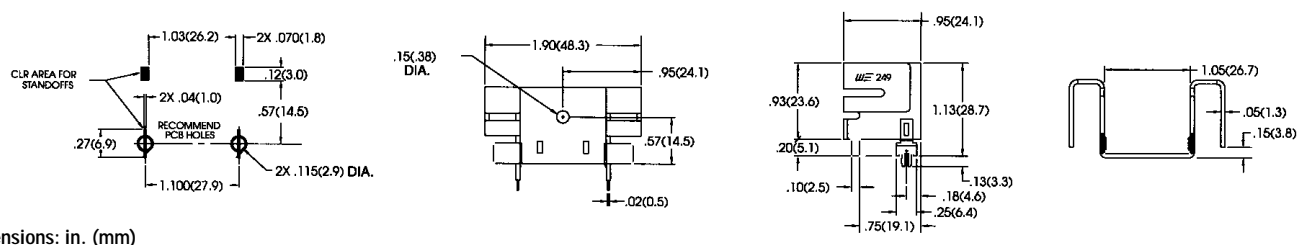



## BOARD LEVEL POWER SEMICONDUCTOR HEAT SINKS



**288 SERIES** Compact Wave-Solderable Low-Cost Heat Sinks

TO-220, TO-202

Standard P/N	Height Above PC Board in. (mm)	Maximum Footprint in. (mm)	Thermal Performance at Typical Load		Weight lbs. (grams)
			Natural Convection	Forced Convection	
288-1AB ▲	1.250 (31.8)	0.875 (22.2) x 0.215 (5.5)	85°C @ 4W	12°C/W @ 200 LFM	0.0057 (2.59)

Mounting tabs are pre-tinned to ensure excellent wave-solder bond and good electrical connections for vertical mounting of TO-220 and TO-202 semiconductor packages. These heat sinks are designed for use where minimum PC

board space is available. The 288-1AB is a stamped aluminum heat sink, black anodized, designed for applications requiring good heat dissipation from a heat sink occupying minimum space, available at minimum cost.

### MECHANICAL DIMENSIONS

#### 288 SERIES

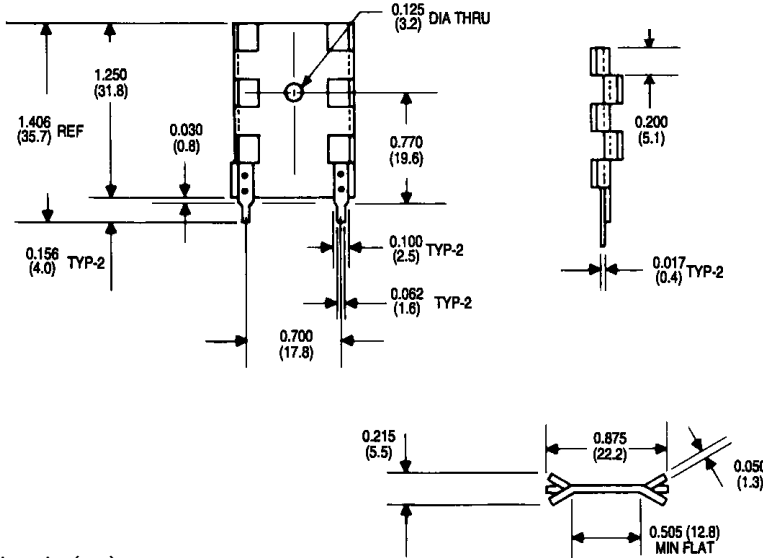

Dimensions: in. (mm)

### NATURAL AND FORCED CONVECTION CHARACTERISTICS

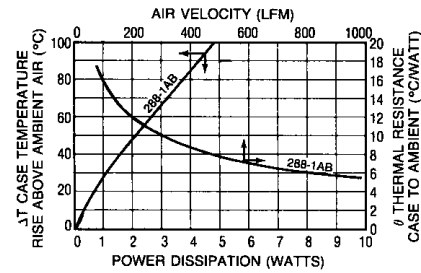

**271 SERIES** Top-Mount Booster Heat Sinks for Use with 270/272/280 Series

TO-220

Standard P/N	Height Above Semiconductor Case in. (mm)	Horizontal Mounting Footprint Dimensions in. (mm)	Thermal Performance at Typical Load		Weight lbs. (grams)
			Natural Convection	Forced Convection	
271-AB ▲	0.500 (12.7)	1.750 (44.5) x 0.700 (17.8)	62°C @ 4W (NOTE A) 31°C @ 4W (NOTE B)	5.1°C/W @ 400 LFM 1.8°C/W 400 LFM (NOTE B)	0.0052 (2.36)

Material: Aluminum, Black Anodized

This top-hat style booster heat sink can be added to any of the 270, 272, or 280 Series for improved performance.

NOTE A: Thermal resistance with one 271-AB. NOTE B: Thermal resistance (total) as shown with (2) 271-AB types added to (1) 272-AB type.

### MECHANICAL DIMENSIONS

#### 271 SERIES

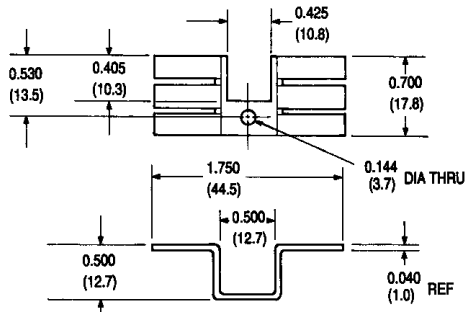

Dimensions: in. (mm)

### NATURAL AND FORCED CONVECTION CHARACTERISTICS

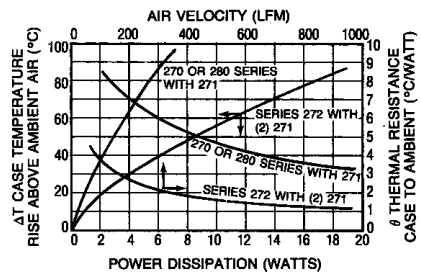

## BOARD LEVEL POWER SEMICONDUCTOR HEAT SINKS



270/272/280 SERIES Small Footprint Low-Cost Heat Sinks

TO-220, TO-202

Standard P/N	Height Above PC Board in. (mm)	Horizontal Mounting Maximum Footing in. (mm)	Solderable Tab Options	Thermal Performance at Typical Load		Weight lbs. (grams)
				Natural Convection	Forced Convection	
270-AB ▲	0.375 (9.4)	1.750 (44.5) x 0.700 (17.8)	—	70°C @ 4W	6.0°C/W @ 400 LFM	0.0052 (2.36)
272-AB ▲	0.375 (9.4)	1.750 (44.5) x 1.450 (36.8)	01,02	42°C @ 4W	3.6°C/W @ 400 LFM	0.0105 (5.72)
280-AB	0.375 (9.4)	1.750 (44.5) x 0.700 (17.8)	—	70°C @ 4W	6.0°C/W @ 400 LFM	0.0048 (2.18)

Material: Aluminum, Black Anodized

These exceptionally low-cost heat sinks can be mounted horizontally under a TO-220 or TO-202 case style with a maximum height of only 0.375 in. (9.4). For added performance, a 271 Series heat sink can also be used for double-sided heat dissi-

ipation. The 270-AB and 280-AB accept one power semiconductor; the 272-AB is designed for two power semiconductors. Specify solderable tab options for the 272 Series by the addition of suffix "01" or "02" to the standard part number (i.e. 272-AB01 or 272-AB02).

### MECHANICAL DIMENSIONS

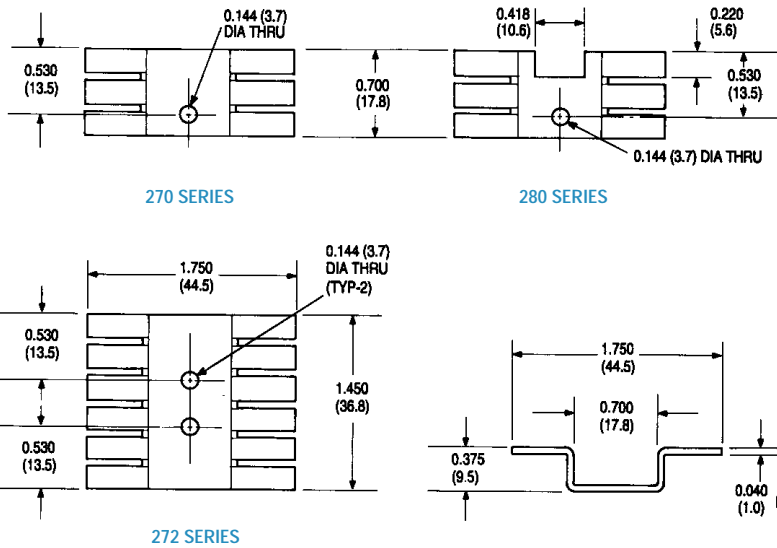

Dimensions: in. (mm)

### NATURAL AND FORCED CONVECTION CHARACTERISTICS

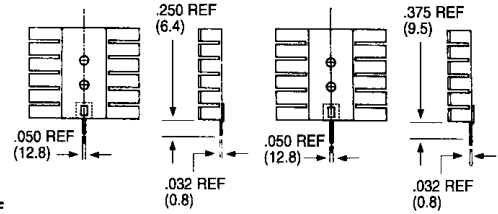
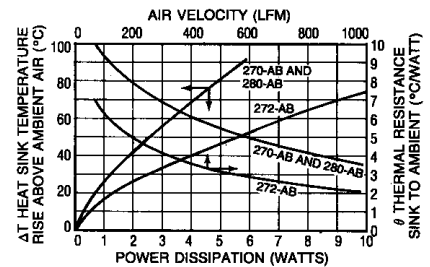

272AB01 272AB02

Note:  
1. Suggested Tab Hole = 0.075 ±0.003 plated with 0.100 pad

289 AND 290 SERIES Low-Cost Single or Dual Package Heat Sinks

TO-218, TO-202, TO-220



Standard P/N	Height Above PC Board in. (mm)	Horizontal Mounting Maximum Footing in. (mm)	Thermal Performance at Typical Load		Weight lbs. (grams)
			Natural Convection	Forced Convection	
289-AB ▲	0.500 (12.7)	1.000 (25.4) x 0.710 (18.1)	50°C @ 2W	44°C/W @ 400 LFM	0.0055 (2.49)
289-AP	0.500 (12.7)	1.000 (25.4) x 0.710 (18.1)	50°C @ 2W	44°C/W @ 400 LFM	0.0055 (2.49)
290-1AB ▲	0.500 (12.7)	1.000 (25.4) x 1.180 (30.0)	44°C @ 2W	35°C/W @ 400 LFM	0.0082 (3.72)
290-2AB ▲	0.500 (12.7)	1.000 (25.4) x 1.180 (30.0)	44°C @ 2W	35°C/W @ 400 LFM	0.0081 (3.67)

Material: Aluminum, Black Anodized

Low in cost and compact in overall dimensions, one 289 Series heat sink can accommodate one semiconductor; the 289 Series is available with a black anodized finish (289-AB) or with

no finish (289-AP). Two semiconductors can be mounted to the 290-2AB style.

### 289 SERIES

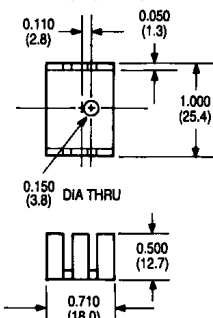

### MECHANICAL DIMENSIONS

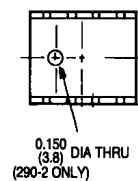

### 290 SERIES

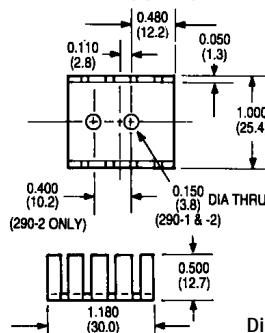

Dimensions: in. (mm)

### NATURAL AND FORCED CONVECTION CHARACTERISTICS

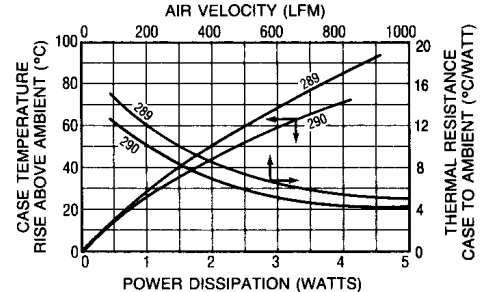

## BOARD LEVEL POWER SEMICONDUCTOR HEAT SINKS



### 250 SERIES High-Performance Slim Profile Heat Sinks With Integral Clips

Multiwatt

Standard P/N	Height Above PC Board in. (mm)	Footprint Dimensions in. (mm)	Mounting Configuration	Solderable Tab Options	Mounting Style	Thermal Performance at Typical Load	
						Natural Convection	Forced Convection
250-122AB	1.220 (31.0)	1.000 (25.4) x .500 (12.7)	Vert./Horiz.	No Tab	Clip	50°C @ 4W	3.7°C/W @ 400 LFM
250-122AB-09 ▲	1.220 (31.0)	1.000 (25.4) x .500 (12.7)	Vertical	09	Clip	50°C @ 4W	3.7°C/W @ 400 LFM
250-122AB-25	1.380 (35.1)	1.000 (25.4) x .500 (12.7)	Vertical	25	Clip	50°C @ 4W	3.7°C/W @ 400 LFM

Material: Aluminum, Black Anodized

#### MECHANICAL DIMENSIONS

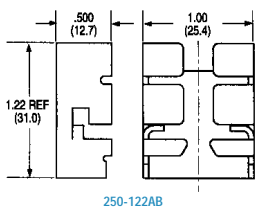

Dimensions: in. (mm)

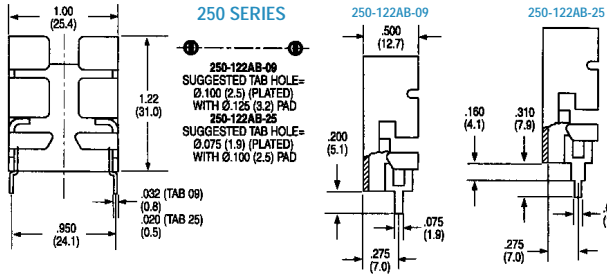

#### NATURAL AND FORCED CONVECTION CHARACTERISTICS

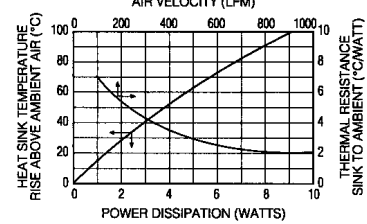

### 237 AND 252 SERIES High-Performance, High-Power Vertical Mount Heat Sinks

TO-220

Standard P/N	Height Above PC Board in. (mm)	Footprint Dimensions in. (mm)	Mounting Configuration	Solderable Tab Options	Mounting Style	Thermal Performance at Typical Load	
						Natural Convection	Forced Convection
237-167AB2	1.675 (42.5)	1.000 (25.4) x 1.000 (25.4)	Vertical	2, Twisted	Clip/Mtg Slot	46°C @ 4W	4.5°C/W @ 200 LFM
237-167AB3	1.675 (42.5)	1.000 (25.4) x 1.000 (25.4)	Vertical	3, Twisted	Clip/Mtg Slot	46°C @ 4W	4.5°C/W @ 200 LFM
237-167AB2-24	1.675 (42.5)	1.000 (25.4) x 1.000 (25.4)	Vertical	2, Solderable	Clip/Mtg Slot	46°C @ 4W	4.5°C/W @ 200 LFM
252-167AB2	1.675 (42.5)	1.000 (25.4) x 1.000 (25.4)	Vertical	2, Twisted	Clip/Mtg Slot	40°C @ 4W	4.5°C/W @ 200 LFM
252-167AB3	1.675 (42.5)	1.000 (25.4) x 1.000 (25.4)	Vertical	3, Twisted	Clip/Mtg Slot	40°C @ 4W	4.5°C/W @ 200 LFM
252-167AB2-24	1.675 (42.5)	1.000 (25.4) x 1.000 (25.4)	Vertical	2, Solderable	Clip/Mtg Slot	40°C @ 4W	4.5°C/W @ 200 LFM

Order SpeedClips™ 285SC or 330SC separately for rapid component installation, lowering manufacturing costs. Material: Aluminum, Black Anodized

#### MECHANICAL DIMENSIONS

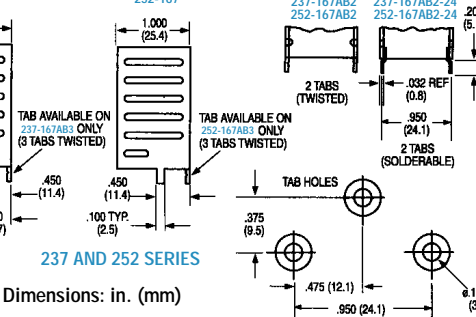
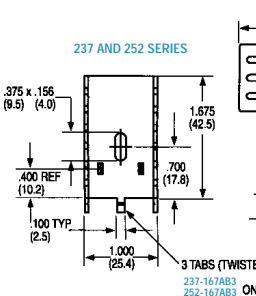

#### NATURAL AND FORCED CONVECTION CHARACTERISTICS

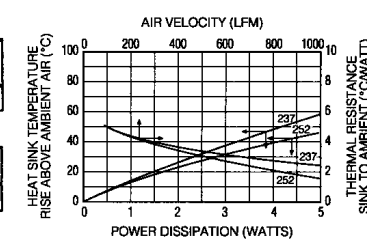

### 291 SERIES Labor-Saving Clip-on Heat Sinks

TO-220

Standard P/N	Height Above PC Board in. (mm)	Vertical Mounting Footprint Dimensions in. (mm)	Mounting Style	Thermal Performance at Typical Load		Weight lbs. (grams)
				Natural Convection	Forced Convection	
291-C236AB	0.860 (21.9)	1.100 (27.0) x 0.360 (9.1)	TO-220 (Clip)	80°C @ 2W	24°C/W @ 600 LFM	0.0026 (1.18)
291-H36AB ▲	0.860 (21.9)	1.100 (27.0) x 0.360 (9.1)	TO-220 (Mtg. Hole)	68°C @ 2W	16°C/W @ 600 LFM	0.0026 (1.18)

Material: Aluminum, Black Anodized

Designed for mounting horizontally or vertically on a circuit board, 291 Series heat sinks employ a unique clip for attachment of TO-220 case styles.

One type is available with a locking clip and one with a 0.140 in. (3.6) diameter mounting hole only.

#### MECHANICAL DIMENSIONS

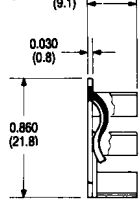

Dimensions: in. (mm)

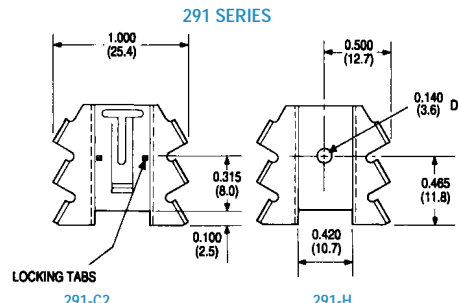

#### NATURAL AND FORCED CONVECTION CHARACTERISTICS

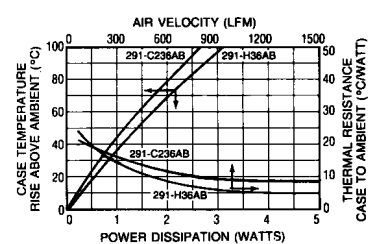

## BOARD LEVEL POWER SEMICONDUCTOR HEAT SINKS



### 286 SERIES Aluminum and Copper Low-Cost Wave-Solderable Heat Sinks

TO-220

Standard P/N	Height Above PC Board in. (mm)	Maximum Footprint in. (mm)	Material	Thermal Performance at Typical Load		Weight lbs. (grams)
				Natural Convection	Forced Convection	
286-AB ▲	1.190 (30.2)	1.000 (25.4) x 0.500 (12.7)	Aluminum, Anodized	58°C @ 4W	7.4°C/W @ 200 LFM	0.0085 (3.86)
286-CBT ▲	1.190 (30.2)	1.000 (25.4) x 0.500 (12.7)	Copper, Black	58°C @ 4W	7.4°C/W @ 200 LFM	0.0250 (11.34)
286-CT	1.190 (30.2)	1.000 (25.4) x 0.500 (12.7)	Copper, Tinned	58°C @ 4W	7.4°C/W @ 200 LFM	0.0250 (11.34)

Efficient heat removal at low cost can be achieved by inserting the 286 Series directly into pre-drilled circuit boards; scored mounting tabs may be bent after insertion to provide added stability.

The 286 Series can be wavesoldered directly to the board. Material: 286-AB style (aluminum, black anodized), 286-CBT style (copper, black paint tin tabs), and 286-CT style (copper, tinned).

#### MECHANICAL DIMENSIONS

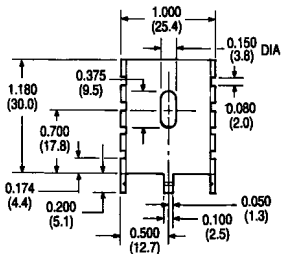

Dimensions: in. (mm)

#### 286 SERIES

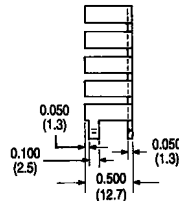

#### NATURAL AND FORCED CONVECTION CHARACTERISTICS

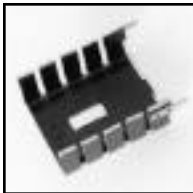
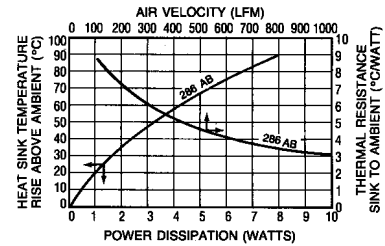

### 287 SERIES Wave-Solderable Low-Cost Heat Sinks

TO-220

Standard P/N	Mounting Slot	Mounting Hole	Height Above PC Board in. (mm)	Maximum Footprint "A" in. (mm)	Thermal Performance at Typical Load		Weight lbs. (grams)
					Natural Convection	Forced Convection	
287-1AB ▲	287-1ABH ▲	287-1ABH ▲	1.180 (30.0)	1.000 (25.4) x 0.500 (12.7)	65°C @ 4W	7.8°C/W @ 200 LFM	0.0090 (4.08)
287-2AB ▲	287-2ABH	287-2ABH	1.180 (30.0)	1.000 (25.4) x 1.000 (25.4)	55°10 @ 4W	6.4°C/W @ 200 LFM	0.0140 (6.35)

Material: Aluminum, Black Anodized

Mount these cost-effective TO-220 heat sinks vertically into pre-drilled printed circuit boards. Soldered, pre-tinned tabs can be wavesoldered directly to the board. A 0.375 in. (9.5 mm)

mounting slot allows for correct positioning of TO-220 and similar semiconductor packages.

#### MECHANICAL DIMENSIONS

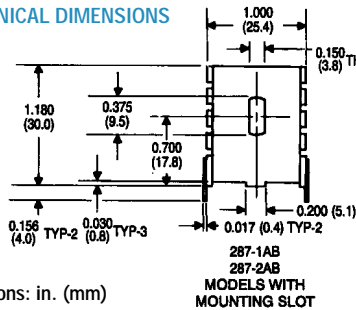

Dimensions: in. (mm)

#### 287 SERIES

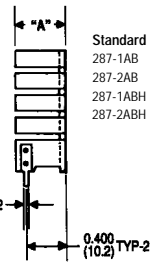
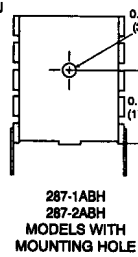

Standard P/N	Dim. "A"
287-1AB	0.500 (12.7)
287-2AB	1.000 (25.4)
287-1ABH	0.500 (12.7)
287-2ABH	1.000 (25.4)

#### NATURAL AND FORCED CONVECTION CHARACTERISTICS

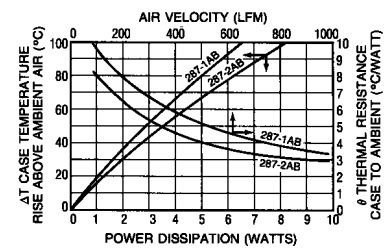

### 695 SERIES Space-Saving Heat Sinks for Small Stud-Mounted Diodes

STUD-MOUNT

Standard P/N	Maximum Width in. (mm)	Height in. (mm)	Thermal Performance at Typical Load		Weight lbs. (grams)
			Natural Convection	Forced Convection	
695-1B ▲	1.330 (33.8)	0.530 (13.7)	72°C @ 4.0W	5.2°C/W @ 400 LFM	0.0030 (1.36)

Mount and effectively heat sink small stud-mounted diodes with the 695 Series space-saving heat sink type. Each unit is black anodized aluminum with an 0.200 in. (5.1) dia. mounting hole centered in the base. The folded fin design

provides good heat dissipation for use where height is limited above the printed circuit board or base plate.

#### MECHANICAL DIMENSIONS

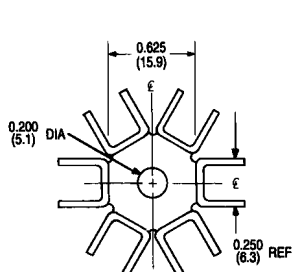

Dimensions: in. (mm)

#### 695 SERIES

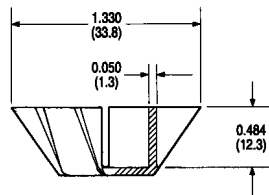

#### NATURAL AND FORCED CONVECTION CHARACTERISTICS

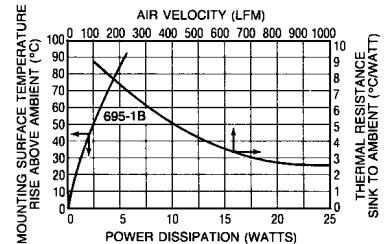

## BOARD LEVEL POWER SEMICONDUCTOR HEAT SINKS



### 256 SERIES Thermal Retainers

Standard P/N	Height (Less Mounting Tab) in. (mm)	Material	Weight lbs. (grams)
256-DM ▲	0.190 (4.0)	Beryllium Copper	0.0005 (0.23)

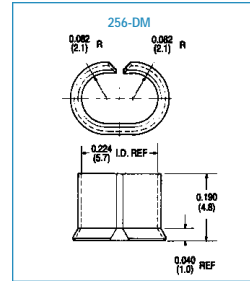

TO-92

### 260 SERIES Cup Clips for TO-5 Case Style Semiconductors

TO-5

Characteristics	TO-5
Thermal Resistance – Epoxy Insulated	14° C/W
Thermal Resistance – Beryllium Oxide Insulated	16° C/W
Breakdown Voltage – Epoxy Type (VAC), 60 Hz	500
Breakdown Voltage – Beryllium Type (VAC), 60 Hz	1000
Recommended Operating Voltage, AC or DC	
Clean Conditions: % Hipot Rating	50
Dusty Conditions: % Hipot Rating	30
Dirty Conditions: % Hipot Rating	10 to 20
Temperature Range — Continuous (C°)	-73/+149

Model	Depth of Tapped Base
260-4T5E	0.093 (2.36)
260-4TH5E	0.125 (3.18)
260-4TH5B	0.125 (3.18)

**Thread Size:**  
4 = #4-40 UNC  
6 = #6-32 UNC  
10 = #10-32 UNF

**Mounting Style:**  
T = tapped  
S = stud  
P = plain

**Base Style:** H = hex  
**Semiconductor Case Style:** 5 = TO-5  
**Insulation Type:** E = epoxy  
B = beryllium



### TO-5 CASE STYLE CUP CLIPS — ORDERING GUIDE

Standard P/N	Insulation Type	Outline Dimension L x W x I.D. in. (mm)	Weight lbs. (grams)	Case Style
260-4T5E ▲	Epoxy Insulated	0.370 (9.4) x 0.380 (9.7) dia. x 0.290 (7.4)	0.0024 (1.09)	TO-5
260-4TH5E ▲	Epoxy Insulated	0.400 (10.2) x 0.370 (9.4) hex. x 0.290 (7.4)	0.0031 (1.41)	TO-5
260-6SH5E ▲	Epoxy Insulated	0.557 (14.1) x 0.370 (9.4) hex. x 0.290 (7.4)	0.0037 (1.68)	TO-5
260-10SH5E	Epoxy Insulated	0.557 (14.1) x 0.370 (9.4) hex. x 0.290 (7.4)	0.0042 (1.91)	TO-5
260-4TH5B ▲	Beryllium Oxide Insulated	0.445 (11.3) x 0.370 (9.4) hex. x 0.290 (7.4)	0.0042 (1.91)	TO-5
260-6SH5B ▲	Beryllium Oxide Insulated	0.607 (15.4) x 0.370 (9.4) hex. x 0.290 (7.4)	0.0039 (1.77)	TO-5
260-10SH5B	Beryllium Oxide Insulated	0.607 (15.4) x 0.370 (9.4) hex. x 0.290 (7.4)	0.0043 (1.95)	TO-5

Materials and Finish: Cups – beryllium copper, black ebonol "C"; Bases – brass, black ebonol "C"; Ceramic Spacers – beryllium oxide

### Base Mounting Configurations — TO-5

**Plain Type** — Epoxy bonded, or used with #4 pan head screws.

**Tapped Base** — #4-40 UNC screw (not supplied) fits tapped hole. Care should be taken not to use too long a screw, which could short against the semiconductor case. For correct screw lengths:

$$\text{Correct Screw Length (L)} = \text{Depth of Base} + \text{Panel Thickness} + \text{Washer Thickness}$$

**Stud Mounting Base.** #6-32 UNC or #10-32 UNF studs. Nuts and washers not supplied. Stud hole must be slightly countersunk to ensure flat mounting.

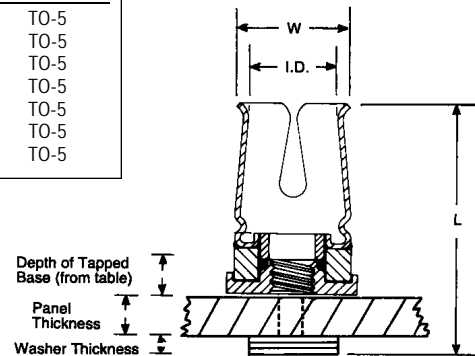
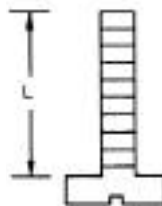

To determine the correct mounting screw lengths, add dimensions as follows:

$$\text{Correct Screw Length (L)} = \text{Depth of Base} + \text{Panel Thickness} + \text{Washer Thickness}$$

### Epoxy Insulated For TO-5

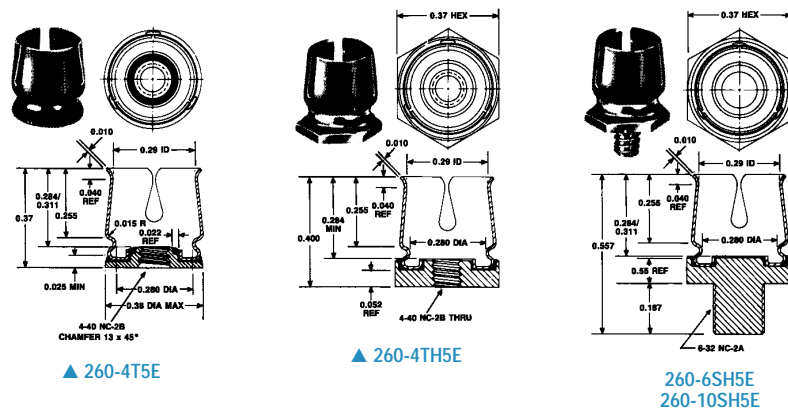

### Beryllium Oxide Insulated For TO-5

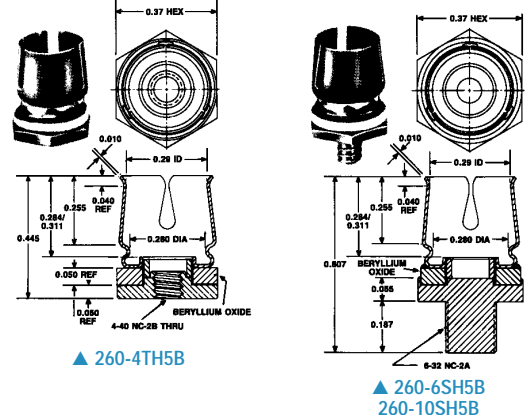

# BOARD LEVEL POWER SEMICONDUCTOR HEAT SINKS

## 200 SERIES High-Efficiency Heat Sinks for Small Metal Can Power Semiconductors

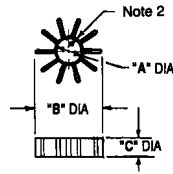

Single-Level Star  
201, 202, 204, 205, 211 Series

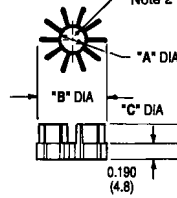

Dual-Level Star  
203, 207, 213 Series

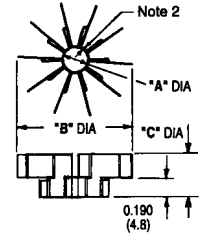
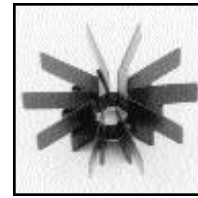

Dual-Level Sunburst  
209, 215 Series

Available Standard P/N & Finish Types	Semiconductor Case Diameter Min/Max in. (mm)	Heat Sink Inside Dia. "A" in. (mm)	Heat Sink Outside Dia. "B" in. (mm)	Heat Sink Height "C" in. (mm)	Natural Convection Case Rise Above Ambient	Forced Convection (CA@200 LFM)	Applicable Power Semiconductor Case Types
▲ 201CB, 201AB	0.161 (4.1)/0.240 (6.1)	0.150 (3.8)	0.640 (16.2)	0.187 (4.8)	65°C @ 1W	31°C/W	TO-18, TO-24, TO-28, TO-40, TO-44
202CB	0.161 (4.1)/0.240 (6.1)	0.150 (3.8)	0.490 (12.5)	0.187 (4.8)	73°C @ 1W	43°C/W	
203CB	0.161 (4.1)/0.240 (6.1)	0.150 (3.8)	0.640 (16.2)	0.375 (9.5)	53°C @ 1W	23°C/W	
204CB ▲, 204SB	0.275 (7.0)/0.370 (9.4)	0.255 (6.5)	0.550 (4.8)	0.187 (4.8)	68°C @ 1W	35°C/W	TO-5, TO-9, TO-11, TO-12, TO-26, TO-29, TO-33, TO-43, TO-45
205CB ▲, 205SB	0.275 (7.0)/0.370 (9.4)	0.255 (6.5)	0.720 (18.3)	0.187 (4.8)	59°C @ 1W	28°C/W	
205AB, 205AP	0.275 (7.0)/0.370 (9.4)	0.255 (6.5)	0.720 (18.3)	0.187 (4.8)	68°C @ 1W	28°C/W	
207CB ▲, 207SB ▲	0.275 (7.0)/0.370 (9.4)	0.255 (6.5)	0.720 (18.3)	0.375 (9.5)	46°C @ 1W	20°C/W	
207AB ▲, 207AP	0.275 (7.0)/0.370 (9.4)	0.255 (6.5)	0.720 (18.3)	0.375 (9.5)	53°C @ 1W	20°C/W	
209CB, 209SB	0.275 (7.0)/0.370 (9.4)	0.255 (6.5)	1.280 (32.5)	0.437 (11.1)	30°C @ 1W	13°C/W	
211CB	0.440 (11.2)/0.544 (13.8)	0.420 (10.7)	0.830 (21.1)	0.187 (4.8)	50°C @ 1W	24°C/W	TO-8, TO-38
213CB, 213SB	0.440 (11.2)/0.544 (13.8)	0.420 (10.7)	0.830 (21.1)	0.375 (9.5)	44°C @ 1W	19°C/W	
213AB, 213AP	0.440 (11.2)/0.544 (13.8)	0.420 (10.7)	0.830 (21.1)	0.375 (9.5)	51°C @ 1W	19°C/W	
215CB, 215AB	0.440 (11.2)/0.544 (13.8)	0.420 (10.7)	1.400 (35.6)	0.437 (11.1)	28°C @ 1W	15°C/W	
215AP	0.440 (11.2)/0.544 (13.8)	0.420 (10.7)	1.400 (35.6)	0.437 (11.1)	32°C @ 1W	15°C/W	

**Materials and Finishes Available for 200 Series:**

- CB Beryllium copper; black ebolon "C" Finish
- SB Silver-bearing copper; black ebolon "C" Finish
- AB Aluminum, black anodized
- AP Aluminum, no finish applied

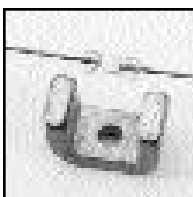
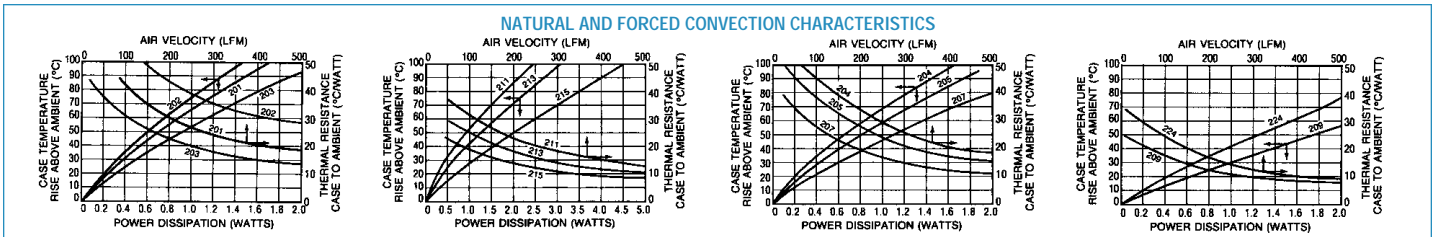

## 258 SERIES Thermal Links for Fused Glass Diodes

DIODES

Standard P/N	Dimensions in. (mm)	Material	Finish	Weight lbs. (grams)
258 ▲	0.500 (12.7) x 0.250 (6.4) x 0.340 (8.6)	Aluminum	DeltaCoate™ 151 on all surfaces except solder pads and base	0.0018 (0.82)

### MECHANICAL DIMENSIONS

258 SERIES

Dimensions: in. (mm)

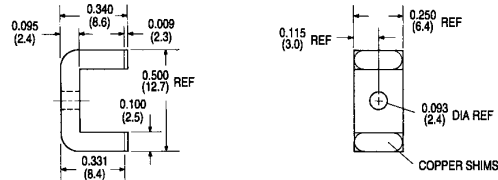

The thermal resistance from diode leads to chassis or heat sink is 12°C/watt, when unit is mounted with TYPE 120 Joint Compound. If a 10°C/watt chassis or sink to ambient impedance is available, the thermal resistance from the diode leads to ambient is reduced from about 150°C/watt to 22°C/watt.

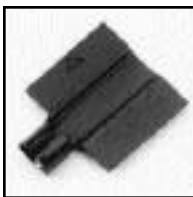

## 292 SERIES Heat Sink for Single TO-92

TO-92

Standard P/N	Height Above PC Board in. (mm)	Overall Fin Width in. (mm)	Thermal Performance Natural Convection	Finish	Weight lbs. (grams)
292-AB ▲	0.750 (19.1)	0.600 (15.3)	0.225°C/W @ 0.250 W	Black Anodized	0.00049 (0.22)

### MECHANICAL DIMENSIONS

292 SERIES

### NATURAL AND FORCED CONVECTION CHARACTERISTICS

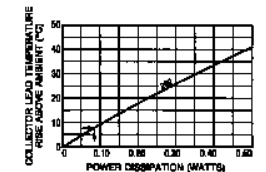
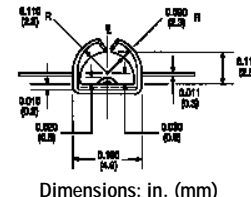
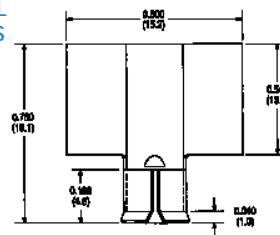

Power semiconductors packaged in a TO-92 style plastic case can be cooled effectively at little additional cost with the addition of the 292-AB heat sink. The 292-AB is effective over the typical power range of such devices. Material: Aluminum, Black Anodized.

## BOARD LEVEL POWER SEMICONDUCTOR HEAT SINKS



### 634 SERIES Slim Profile Unidirectional Fin Vertical Mount Heat Sink

TO-220 and TO-218

Plain Pin	Standard P/N		Height Above PC Board in. (mm)	Footprint Dimensions in. (mm)	Weight lbs. (grams)
	With Pin	Without Pin			
634-10ABP ▲	634-10AB		1.000 (25.4)	0.640 (16.26) x 0.640 (16.26)	0.016 (7.48)
634-15ABP ▲	634-15AB		1.500 (38.1)	0.640 (16.26) x 0.640 (16.26)	0.025 (11.21)
634-20ABP ▲	634-20AB		2.000 (50.8)	0.640 (16.26) x 0.640 (16.26)	0.033 (14.95)

Material: Aluminum, Black Anodized.

These slim profile unidirectional fin heat sinks offer users two assembly alternatives for vertically mounting TO-220 and TO-218 components. Models are available with or without wave-

solderable pins on 0.40 in. (10.2) centers, making them ideal for a variety of applications where quick assembly is needed and space is at a premium.

### MECHANICAL DIMENSIONS

#### 634 SERIES

**Notes:**

1. Thermal compound is assumed between device and heat sink.
2. Tab temp with longer heat sink (634-20ABP) will typically be about 15% cooler. Tab temp with shorter heat sink (634-10ABP) will typically be about 25% higher.

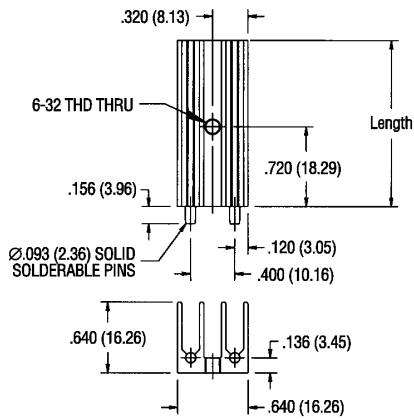

Dimensions: in. (mm)

### TYPICAL THERMAL PERFORMANCE FOR 634-15ABP

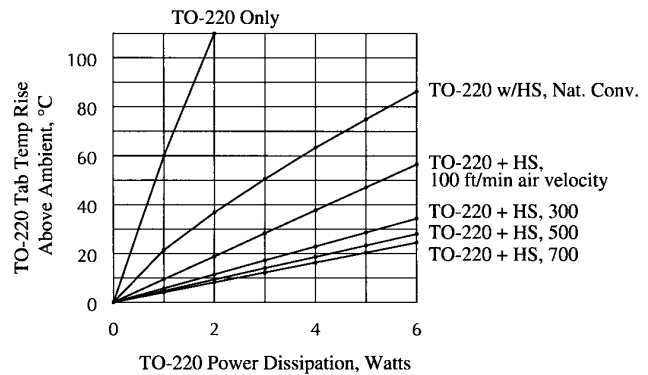

### 637 SERIES High-Efficiency Heat Sinks For Vertical Board Mounting

TO-220

Standard P/N	Height Above PC Board "A" in. (mm)	Maximum Footprint in. (mm)	Thermal Performance at Typical Load		Weight lbs. (grams)
			Natural Convection	Forced Convection	
637-10ABP ▲	1.000 (25.4)	1.375 (34.9) x 0.500 (12.7)	76°C @ 6W	5.8°C/W @ 200 LFM	0.023 (10.43)
637-15ABP ▲	1.500 (38.1)	1.375 (34.9) x 0.500 (12.7)	65°C @ 6w	5.5°C/W @ 200 LFM	0.035 (15.88)
637-20ABP ▲	2.000 (50.8)	1.375 (34.9) x 0.500 (12.7)	55°C @ 6W	4.7°C/W @ 200 LFM	0.050 (22.68)
637-25ABP ▲	2.500 (63.5)	1.375 (34.9) x 0.500 (12.7)	48°C @ 6W	4.2°C/W @ 200 LFM	0.062 (28.12)

Material: Aluminum, Black Anodized

Wave-solderable pins on 1 in. centers for vertical mounting on printed circuit boards. Maximum semiconductor package width 0.625 in. (15.9). Use this heat sink where weight

and board space occupied must be minimized. Refer to the Accessory products section for thermal interface materials, thermal compounds, and other accessories products.

### MECHANICAL DIMENSIONS

#### 637 SERIES (EXTRUSION PROFILE 5183)

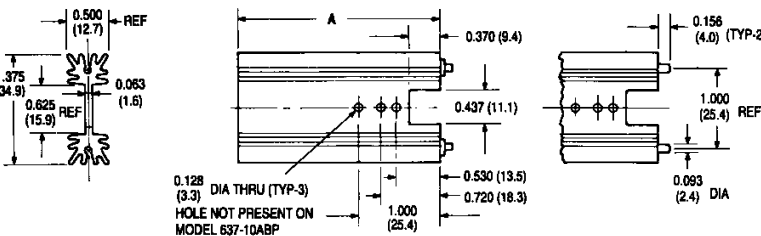

Dimensions: in. (mm)

### NATURAL AND FORCED CONVECTION CHARACTERISTICS

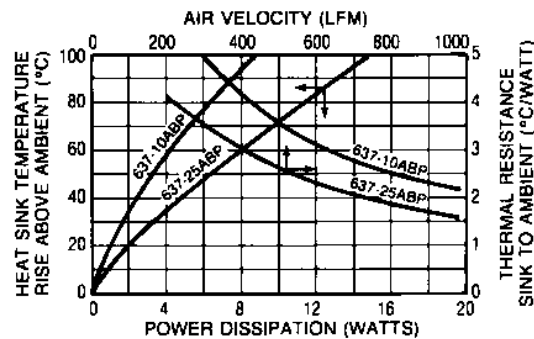

**BOARD LEVEL POWER SEMICONDUCTOR HEAT SINKS**

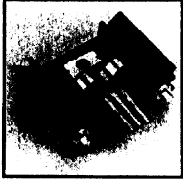

**667 SERIES Labor-Saving SpeedClip™ Heat Sinks for Vertical Board Mounting**

TO-220

Standard P/N	Plain Pin	Height Above PC Board "A" in. (mm)	Maximum Footprint in. (mm)	Thermal Performance at Typical Load		Weight lbs (grams)
Standoff Pin				Natural Convection	Forced Convection	
667-10ABSP ▲	667-10ABPP ▲	1.000 (25.4)	1.375 (34.9) x 0.500 (12.7)	76°C @ 6W	5.8°C/W @ 200 LFM	0.0240 (11.0)
667-15ABSP	667-15ABPP ▲	1.500 (38.1)	1.375 (34.9) x 0.500 (12.7)	66°C @ 6W	5.5°C/W @ 200 LFM	0.0340 (15.6)
667-20ABSP	667-20ABPP	2.000 (50.8)	1.375 (34.9) x 0.500 (12.7)	58°C @ 6W	4.7°C/W @ 200 LFM	0.0460 (21.0)
667-25ABSP	667-25ABPP	2.500 (63.5)	1.375 (34.9) x 0.500 (12.7)	48°C @ 6W	4.2°C/W @ 200 LFM	0.0580 (26.2)

Wave-solderable pins. Material: Aluminum, Black Anodized

Excellent performance, choice of wave-solderable plain pins (PP-Type) or wave-solderable hex-shaped standoff pins (SP-Type), and reduced assembly cost.

Note: Order 330 SC or 285 SC SpeedClip™ separately.

**MECHANICAL DIMENSIONS**

**667 SERIES (EXTRUSION PROFILE 8073)**

**NATURAL AND FORCED CONVECTION CHARACTERISTICS**

Dimensions: in. (mm)

**285 AND 330 SERIES 285 SC and 330 SC SpeedClips™ for 667 Series Heat Sinks**

Standard P/N	Nominal Installed Loading Force	For Use With Series	Material	Weight lbs. (grams)
285 SC	10 lbs	232, 237, 240, 252, 667	Carbon Steel	0.00053 (0.24)
330 SC	4 lbs	232, 237, 240, 252, 667	Stainless Steel	0.00074 (0.34)

SpeedClips™ employ a locking safety tab for mounting. Must be ordered separately for these heat sink series. Use these SpeedClips™ with our 237, 240, 252, and 667 Series heat sinks for the lowest production assembly time and cost. Order one SpeedClip™ for each 667 Series heat sink purchased.

**MECHANICAL DIMENSIONS**

**Speed Clip 330 SC**  
4 lb Nominal Force Installed

**Speed Clip 285 SC**  
10 lb Nominal Force Installed

Dimensions: in. (mm)

**647 SERIES High-Performance Heat Sinks for Vertical Board Mounting**

TO-220

Standard P/N	Height Above PC Board "A" in. (mm)	Maximum Footprint in. (mm)	Thermal Performance at Typical Load		Weight lbs. (grams)
			Natural Convection	Forced Convection	
647-10ABP ▲	1.000 (25.4)	1.650 (41.9) x 1.000 (25.4)	42°C @ 6W	3.8°C/W @ 200 LFM	0.055 (24.95)
647-15ABP ▲	1.500 (38.1)	1.650 (41.9) x 1.000 (25.4)	37°C @ 6W	3.5°C/W @ 200 LFM	0.075 (34.02)
647-175ABP	1.750 (44.5)	1.650 (41.9) x 1.000 (25.4)	34°C @ 6W	3.3°C/W @ 200 LFM	0.090 (40.82)
647-20ABP ▲	2.000 (50.8)	1.650 (41.9) x 1.000 (25.4)	31°C @ 6W	3.1°C/W @ 200 LFM	0.104 (47.17)
647-25ABP	2.500 (63.5)	1.650 (41.9) x 1.000 (25.4)	25°C @ 6W	2.8°C/W @ 200 LFM	0.125 (56.70)

Material: Aluminum, Black Anodized

Wave-solderable pins on 1 in. centers for vertical mounting of larger devices on printed circuit boards. Maximum semiconductor package width: 0.625 (15.9). Refer to the Accessory

Products section for thermal interface materials, 126 Series silicone-free thermal compounds, and other accessories products.

**MECHANICAL DIMENSIONS**

**647 SERIES (EXTRUSION PROFILE 5195)**

**NATURAL AND FORCED CONVECTION CHARACTERISTICS**

Dimensions: in. (mm)

▲ Normally stocked



## BOARD LEVEL POWER SEMICONDUCTOR HEAT SINKS



626 AND 627 SERIES High-Efficiency Heat Sinks for Vertical Board Mounting

TO-218, TO-220

Standard P/N	Standard P/N	Height Above PC Board "A" in. (mm)	Maximum Footprint in. (mm)	Thermal Performance at Typical Load	
				Natural Convection	Forced Convection
626-10ABP	627-10ABP	1.000 (25.4)	1.375 (34.9) x .500 (12.7)	76°C @ 6W	5.8°C/W @ 200 LFM
626-15ABP	627-15ABP	1.500 (38.1)	1.375 (34.9) x .500 (12.7)	65°C @ 6W	5.5°C/W @ 200 LFM
626-20ABP	627-20ABP	2.000 (50.8)	1.375 (34.9) x .500 (12.7)	55°C @ 6W	4.7°C/W @ 200 LFM
626-25ABP	627-25ABP	2.500 (63.5)	1.375 (34.9) x .500 (12.7)	48°C @ 6W	4.2°C/W @ 200 LFM

Wave-solderable pins. Material: Aluminum, Black Anodized

### MECHANICAL DIMENSIONS

### 626 AND 627 SERIES

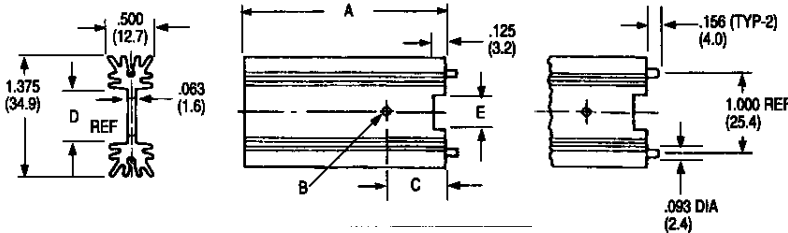

### NATURAL AND FORCED CONVECTION CHARACTERISTICS

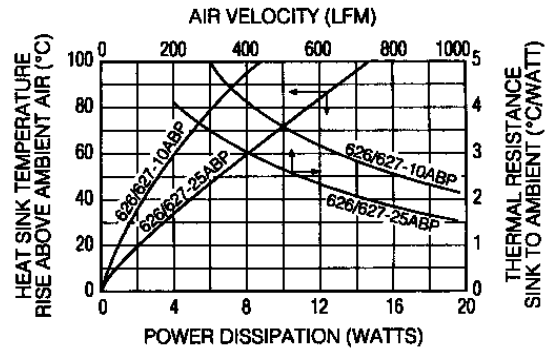

Series	Type Device	Hole Diameter "B"	Hole Height "C"	Webb Width "D"	Notch Width "E"	Extrusion Profile
626	TO-218	.144 (3.7)	.850 (21.6)	.660 (16.8)	.540 (13.7)	8420
627	TO-220	.128 (3.3)	.720 (18.3)	.625 (15.9)	.437 (11.1)	5183

Dimensions: in. (mm)

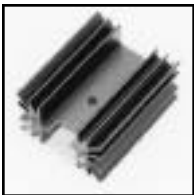

657 SERIES High-Performance Heat Sinks for Vertical Board Mounting

TO-220, TO-247, TO-218

Standard P/N	Height Above PC Board "A" in. (mm)	Maximum Footprint in. (mm)	Thermal Performance at Typical Load		Weight lbs (grams)
			Natural Convection	Forced Convection	
657-10ABP ▲	1.000 (25.4)	1.650 (41.9) x 1.000 (25.4)	41°C @ 6W	3.7°C/W @ 200 LFM	0.0515 (23.36)
657-15ABP ▲	1.500 (38.1)	1.650 (41.9) x 1.000 (25.4)	38°C @ 6W	3.3°C/W @ 200 LFM	0.0760 (34.60)
657-20ABP ▲	2.000 (50.8)	1.650 (41.9) x 1.000 (25.4)	32°C @ 6W	2.9°C/W @ 200 LFM	0.1030 (47.00)
657-25ABP ▲	2.500 (63.5)	1.650 (41.9) x 1.000 (25.4)	25°C @ 6W	2.7°C/W @ 200 LFM	0.1250 (57.00)

Wave-solderable pins. Material: Aluminum, Black Anodized

### MECHANICAL DIMENSIONS

### 657 SERIES

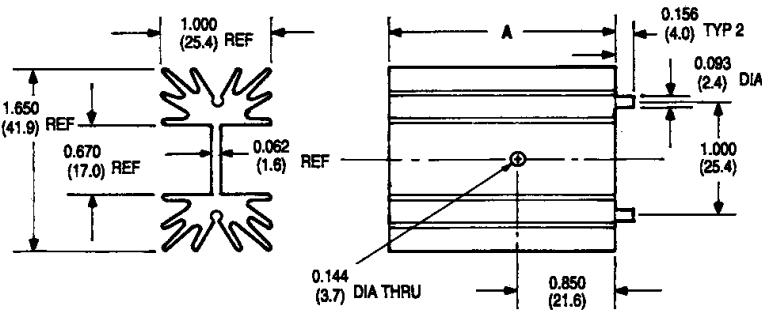

### NATURAL AND FORCED CONVECTION CHARACTERISTICS

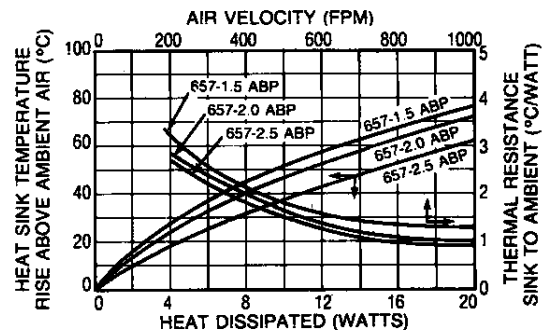

Dimensions: in. (mm)

657 SERIES  
(EXTRUSION PROFILE 6533)

## BOARD LEVEL POWER SEMICONDUCTOR HEAT SINKS

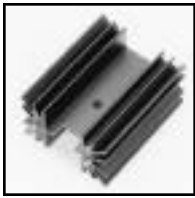

### 657 SERIES High-Performance Notched Heat Sinks for Vertical Board Mounting

TO-220, TO-247, TO-218

Standard P/N	Height Above PC Board "A" in. (mm)	Maximum Footprint in. (mm)	Thermal Performance at Typical Load	
			Natural Convection	Forced Convection
657-10ABPN	1.000 (25.4)	1.650 (41.9) x 1.000 (25.4)	41°C @ 6W	3.7°C/W @ 200 LFM
657-15ABPN ▲	1.500 (38.1)	1.650 (41.9) x 1.000 (25.4)	38°C @ 6W	3.3°C/W @ 200 LFM
657-20ABPN	2.000 (50.8)	1.650 (41.9) x 1.000 (25.4)	32°C @ 6W	2.9°C/W @ 200 LFM
657-25ABPN	2.500 (63.5)	1.650 (41.9) x 1.000 (25.4)	25°C @ 6W	2.7°C/W @ 200 LFM

Wave-solderable pins. Material: Aluminum, Black Anodized

#### MECHANICAL DIMENSIONS

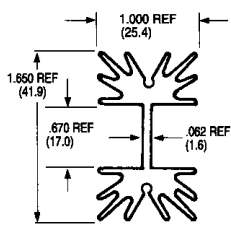

Dimensions: in. (mm)

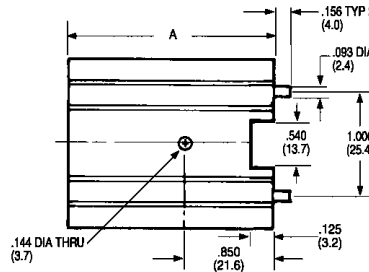

#### 657 SERIES

657 SERIES (EXTRUSION PROFILE 6533)

#### NATURAL AND FORCED CONVECTION CHARACTERISTICS

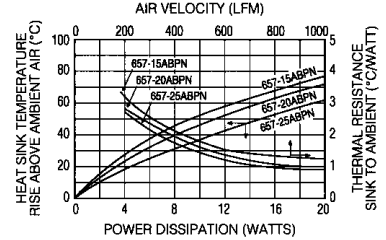

### 657 SERIES High-Performance Heat Sinks with SpeedClips™ for Vertical Board Mounting

TO-220, TO-247, TO-218

Standard P/N	Height Above PC Board "A" in. (mm)	Maximum Footprint in. (mm)	Thermal Performance at Typical Load	
			Natural Convection	Forced Convection
657-10ABPSC	1.000 (25.4)	1.650 (41.9) x 1.000 (25.4)	41°C @ 6W	3.7°C/W @ 200 LFM
657-15ABPSC	1.500 (38.1)	1.650 (41.9) x 1.000 (25.4)	38°C @ 6W	3.3°C/W @ 200 LFM
657-20ABPSC	2.000 (50.8)	1.650 (41.9) x 1.000 (25.4)	32°C @ 6W	2.9°C/W @ 200 LFM
657-25ABPSC ▲	2.500 (63.5)	1.650 (41.9) x 1.000 (25.4)	25°C @ 6W	2.7°C/W @ 200 LFM

Wave-solderable pins. Material: Aluminum, Black Anodized

#### MECHANICAL DIMENSIONS

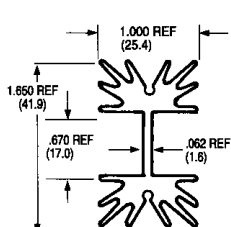

Dimensions: in. (mm)

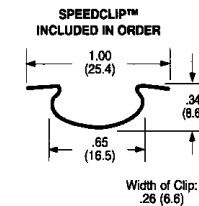
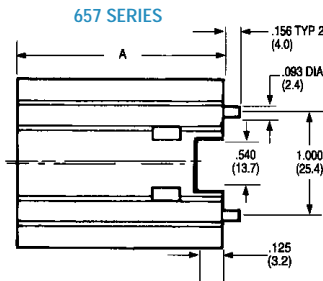

657 SERIES (EXTRUSION PROFILE 6533)

#### NATURAL AND FORCED CONVECTION CHARACTERISTICS

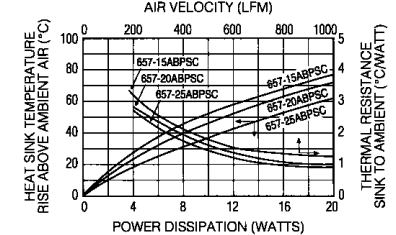

### 677 SERIES High-Performance, High-Power Heat Sinks for Vertical Board Mounting

TO-218, TO-220, TO-247  
15-LEAD Multiwatt

Standard P/N	Height Above PC Board "A" in. (mm)	Maximum Footprint in. (mm)	Thermal Performance at Typical Load	
			Natural Convection	Forced Convection
677-10ABP	1.000 (25.4)	1.650 (41.9) x 1.000 (25.4)	52°C @ 6W	3.1°C/W @ 200 LFM
677-15ABP	1.500 (38.1)	1.650 (41.9) x 1.000 (25.4)	46°C @ 6W	2.8°C/W @ 200 LFM
677-20ABP	2.000 (50.8)	1.650 (41.9) x 1.000 (25.4)	40°C @ 6W	2.5°C/W @ 200 LFM
677-25ABP	2.500 (63.5)	1.650 (41.9) x 1.000 (25.4)	35°C @ 6W	2.2°C/W @ 200 LFM

Wave-solderable pins. Material: Aluminum, Black Anodized

#### MECHANICAL DIMENSIONS

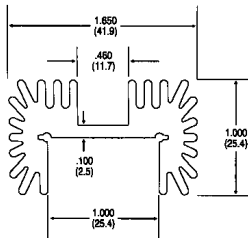

Dimensions: in. (mm)

#### 677 SERIES

677 SERIES (EXTRUSION PROFILE 8719)

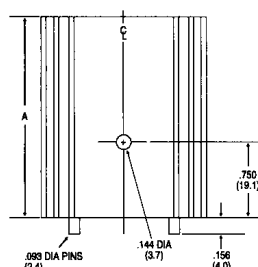

#### NATURAL AND FORCED CONVECTION CHARACTERISTICS

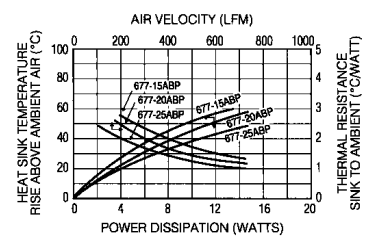

## BOARD LEVEL POWER SEMICONDUCTOR HEAT SINKS



### 690 SERIES Highest Efficiency/Lowest Unit Cost Heat Sinks

TO-3, TO-66, TO-220

Standard P/N	Height Above PC Board in. (mm)	Outline Dimensions in. (mm)	Thermal Performance at Typical Load		Semiconductor Mounting Hole Pattern	Weight lbs. (grams)
			Natural Convection	Forced Convection		
690-3B ▲	1.310 (33.3)	1.860 (47.2)-sq	44°C @ 7.5W	2.0°C/W @ 400 LFM	(1) TO-3	0.0700 (31.75)
690-66B	1.310 (33.3)	1.860 (47.2)-sq	44°C @ 7.5W	2.0°C/W @ 400 LFM	(1) TO-66	0.0700 (31.75)
690-220B	1.310 (33.3)	1.860 (47.2)-sq	44°C @ 7.5W	2.0°C/W @ 400 LFM	(2) TO-220	0.0700 (31.75)

Material: Aluminum, Black Anodized

These low-cost heat sinks provide the most power dissipation at the lowest unit cost and are available in three standard types to mount and cool one TO-3 or TO-66 metal power semiconductor type or two plastic package TO-220 power semiconductor types. For higher power

semiconductors, the 690 Series can dissipate up to 20 watts while maintaining a mounting surface temperature rise above ambient air temperature of no more than 91°C.

#### MECHANICAL DIMENSIONS

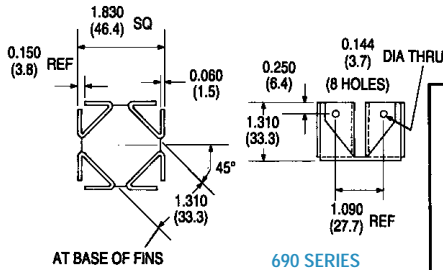

#### SEMICONDUCTOR MOUNTING HOLES

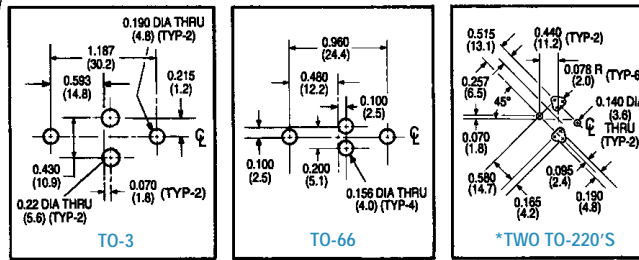

#### NATURAL AND FORCED CONVECTION CHARACTERISTICS

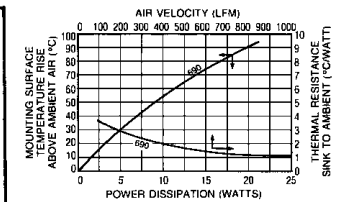

### 680 SERIES Maximum Efficiency Omnidirectional Heat Sinks

TO-3, TO-220

Standard P/N	Height Above PC Board "A" in. (mm)	Horizontal Mounting Footprint Dimensions in. (mm)	Thermal Performance at Typical Load		Semiconductor Mounting Hole Pattern	Weight lbs. (grams)
			Natural Convection	Forced Convection		
680-5A ▲	0.500 (12.7)	1.810 (46.0)-sq	70°C @ 7.5W	3.0°C/W @ 400 LFM	(1) TO-3	0.0700 (31.75)
680-75A ▲	0.750 (19.1)	1.810 (46.0)-sq	58°C @ 7.5W	2.4°C/W @ 400 LFM	(1) TO-3	0.0900 (40.82)
680-10A ▲	1.000 (25.4)	1.810 (46.0)-sq	52°C @ 7.5W	2.0°C/W @ 400 LFM	(1) TO-3	0.0980 (44.45)
680-125A ▲	1.250 (31.8)	1.810 (46.0)-sq	45°C @ 7.5W	1.5°C/W @ 400 LFM	(1) TO-3	0.1100 (49.90)
680-5220	0.500 (12.7)	1.810 (46.0)-sq	70°C @ 7.5W	3.0°C/W @ 400 LFM	(2) TO-220	0.0700 (31.75)
680-75220	0.750 (19.1)	1.810 (46.0)-sq	58°C @ 7.5W	2.4°C/W @ 400 LFM	(2) TO-220	0.0900 (40.82)
680-10220 ▲	1.000 (25.4)	1.810 (46.0)-sq	52°C @ 7.5W	2.0°C/W @ 400 LFM	(2) TO-220	0.0980 (44.45)
680-125220 ▲	1.250 (31.8)	1.810 (46.0)-sq	45°C @ 7.5W	1.5°C/W @ 400 LFM	(2) TO-220	0.1100 (49.90)

Material: Aluminum, Black Anodized

Achieve optimum natural convection cooling per unit volume occupied above the printed circuit board for TO-3 (one semiconductor package per heat sink) or for two TO-220 style cases, when this low-cost heat sink is used. Any mounting attitude will provide free circulation

of air in natural convection applications. These 680 Series heat sinks can also be specified without any semiconductor mounting hole pattern by specifying suffix "K" (Example: 680-5K).

#### MECHANICAL DIMENSIONS

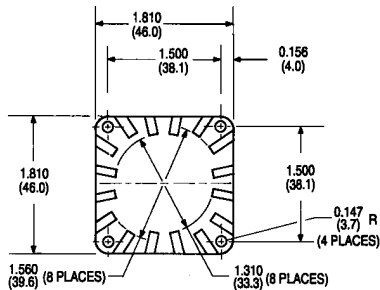

#### 680 SERIES

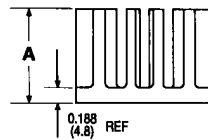

#### NATURAL AND FORCED CONVECTION CHARACTERISTICS

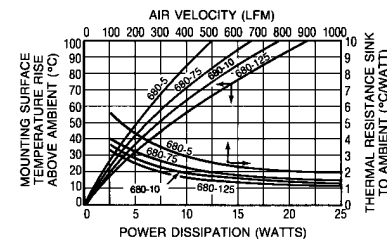

#### SEMICONDUCTOR MOUNTING HOLES

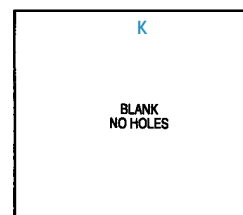
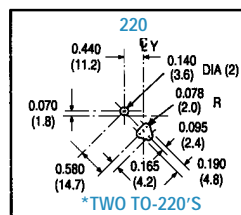
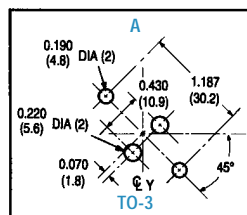

\*Only one hole pattern of two is shown. Hole patterns are symmetrical about the center lines.

## BOARD LEVEL POWER SEMICONDUCTOR HEAT SINKS



### 601 AND 603 SERIES Low-Height Heat Sinks

DO-4/DO-5 Diodes

Standard P/N	Footprint Dimensions in. (mm)	Height in. (mm)	Mounting Hole Dia. in. (mm)	Thermal Performance at Typical Load		Weight lbs. (grams)
				Natural Convection	Forced Convection	
601E	2.000 (50.8) x 1.250 (31.8)	0.562 (14.3)	0.200 (5.1)	52°C @ 5.0W	4.5°C/W @ 175 LFM	0.0500 (22.68)
601F	2.000 (50.8) x 1.250 (31.8)	0.562 (14.3)	0.270 (6.9)	52°C @ 5.0W	4.5°C/W @ 175 LFM	0.0500 (22.68)
601K	2.000 (50.8) x 1.250 (31.8)	0.562 (14.3)	None	52°C @ 5.0W	4.5°C/W @ 175 LFM	0.0500 (22.68)
603K	2.000 (50.8) x 2.000 (50.8)	0.562 (14.3)	None	41°C @ 5.0W	4.0°C/W @ 175 LFM	0.0810 (36.74)

Material: Aluminum Alloy, Black Anodized

Use these low-height heat sinks on printed circuit board applications for TO-66 power semiconductors and DO-4 and DO-5 diodes, where close board-to-board spacing and efficient

heat dissipation are required. The 601 and 603 Series may also be attached to enclosure panels or brackets using isolation hardware where necessary.

### MECHANICAL DIMENSIONS

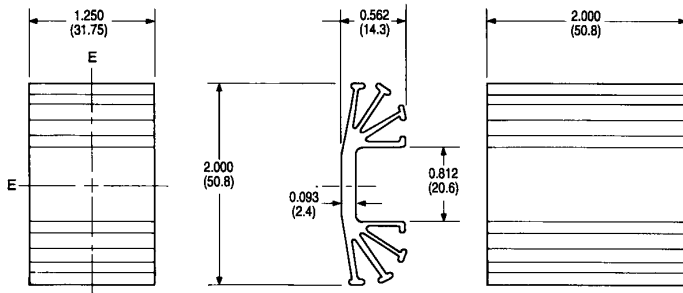

601 SERIES (EXTRUSION PROFILE 1284)

603 SERIES (EXTRUSION PROFILE 1284)

### SEMICONDUCTOR MOUNTING HOLES

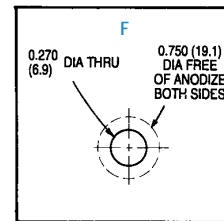
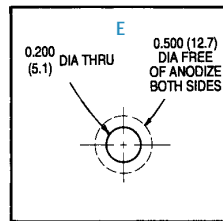
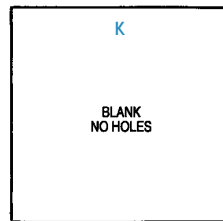

Dimensions: in. (mm)

E&F available on 601 Series only as a standard product.

### NATURAL AND FORCED CONVECTION CHARACTERISTICS

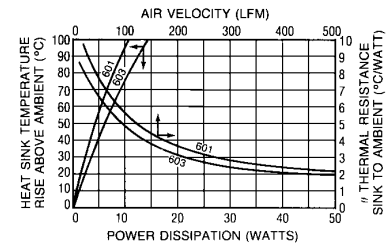

### 635 SERIES Space-Saving Low-Cost Heat Sinks

TO-3

Standard P/N	Height Above PC Board "A" in. (mm)	Outline Dimensions in. (mm)	Thermal Performance at Typical Load		Semiconductor Mounting Hole Pattern	Weight lbs. (grams)
			Natural Convection	Forced Convection		
635-5B2	0.500 (12.7)	1.900 (48.3) x 1.420 (36.0)	90°C @ 8.0W	6.0°C/W @ 300 LFM	TO-3	0.0200 (9.07)
635-75B2	0.750 (19.1)	1.900 (48.3) x 1.420 (36.0)	77°C @ 8.0W	4.8°C/W @ 300 LFM	TO-3	0.0220 (9.98)
635-10B2	1.000 (25.4)	1.900 (48.3) x 1.420 (36.0)	61°C @ 8.0W	3.6°C/W @ 300 LFM	TO-3	0.024 (10.89)
635-125B2	1.250 (31.8)	1.900 (48.3) x 1.420 (36.0)	53°C @ 8.0W	3.1°C/W @ 300 LFM	TO-3	0.028 (12.70)

Material: Aluminum Alloy, Black Anodized

Use this low-cost TO-3 heat sink style for multiple TO-3 applications on a single printed circuit board, where two or more TO-3s must be placed in proximity and minimum space is

available for heat sinking. Four different heights are available, all with TO-3 mounting hole pattern in the base. Consult factory for TO-66, TO-220, and multilead IC hole patterns.

### MECHANICAL DIMENSIONS

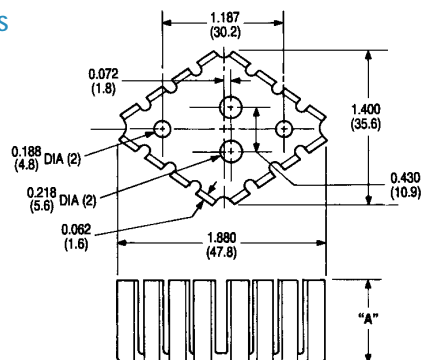

635 SERIES

Dimensions: in. (mm)

### NATURAL AND FORCED CONVECTION CHARACTERISTICS

