

# 50X50X15 mm

# SUNON

## MagLev Motor Fan

## 10.2~17 CFM



Model	P/N	Bearing ● VAPO ⊙ 2BALL	Rating Voltage (VDC)	Power Current (AMP)	Power Consumption (WATTS)	Speed (RPM)	Air Flow (CFM)	Static Pressure (Inch-H <sub>2</sub> O)	Noise (dBA)	Weight (g)
KDE0505PHV2	MS.A.GN	●	5	0.15	0.8	4700	13.0	0.17	29	39
KDE0505PHV3	MS.A.GN	●	5	0.09	0.5	3700	10.2	0.12	22	39
KDE1205PHV1	MS.A.GN	●	12	0.11	1.3	5800	17.0	0.23	33	38
KDE1205PHV2	MS.A.GN	●	12	0.07	0.8	4700	13.0	0.17	29	38
KDE1205PHV3	MS.A.GN	●	12	0.04	0.5	3700	10.2	0.12	22	38
KDE2405PHV1	MS.A.GN	●	24	0.063	1.5	5800	17.0	0.23	33	39
KDE2405PHV2	MS.A.GN	●	24	0.042	1.0	4700	13.0	0.17	29	39

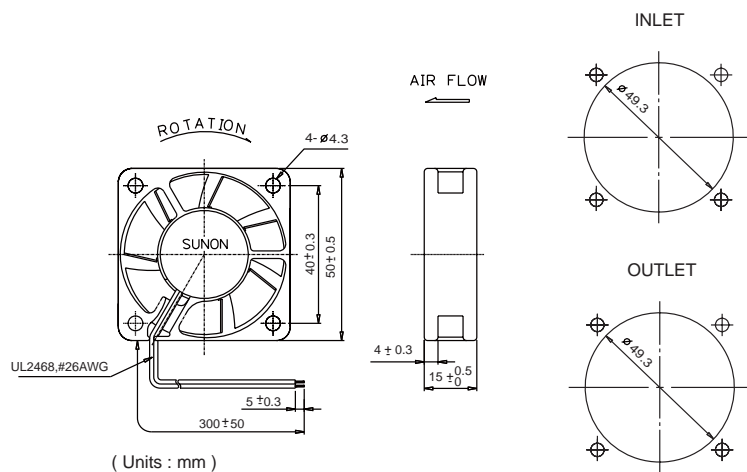
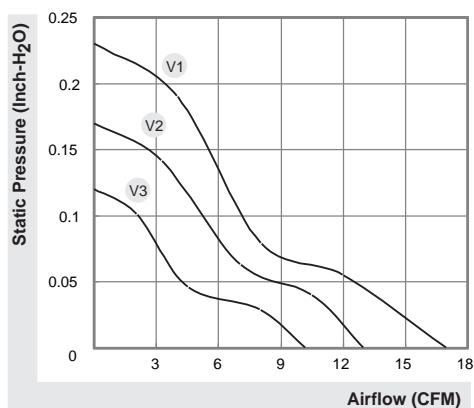

\*All model could be customized on voltage or any other requirements to fit your need.

\*Specifications subject to change without notice. Please Visit SUNON web site at <http://www.sunon.com> for update information.

# Fan 3rd Wire Signal

Fan with switching driving circuit designed for rpm measurement:

These fan motors have three lead wires:

+:Red,

-:Black,

output signal for 3rd wire:

F Type : Yellow

R Type : White

## ● R Type (Rotation Detector)

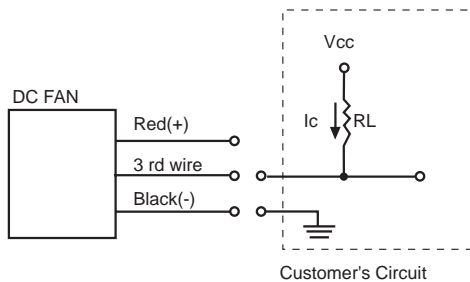
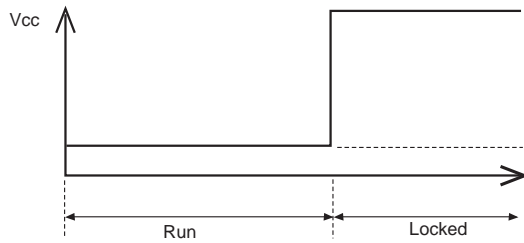

## ● F Type (Frequency Generator)

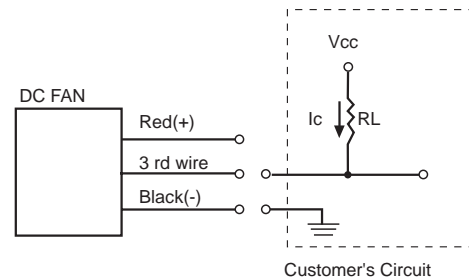
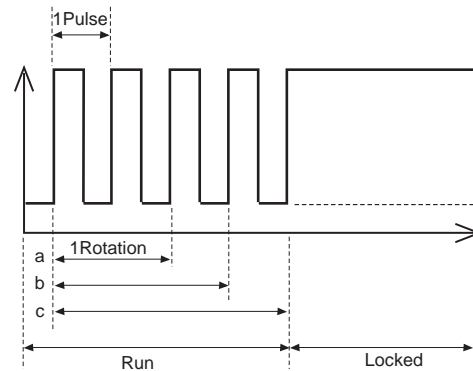

The relationship between rotation & output pulses signal from 3rd wire are as follows:

(a) 1 Rotation=2 Pulses(4 poles' motor)

(b) 1 Rotation=3 Pulses(6 poles' motor)

(c) 1 Rotation=4 Pulses(8 poles' motor)

Notice:

For 8 poles' motor: normally,

1Rotation=4 pulses, if frequency divided circuit is implemented in this motor then

1Rotation=2 pulses.

## Safety



## Certification



# DC Fan and Blower Model Numbering System

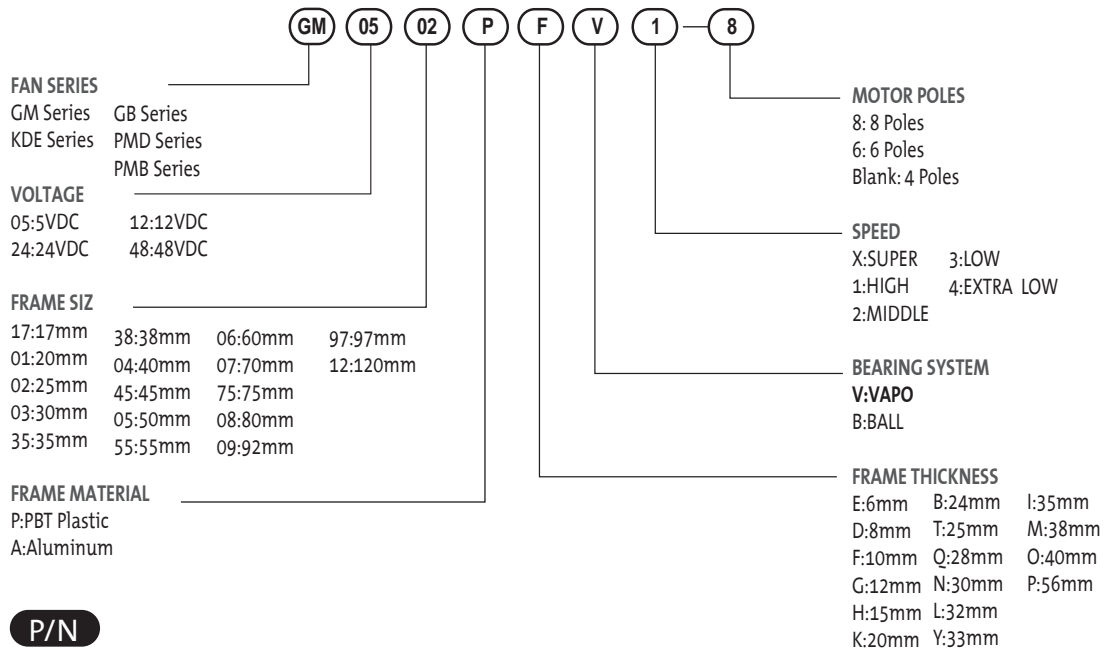

## P/N

Example: KDE1208PTV1 P/N:13.MS.A.GN

- 11/13 Motor model
- MS MagLev Design
- (2) Two ball bearing
- G Big hub
- (9) 9 Blades
- N Smaller hub
- A Auto restart
- F 3rd wire with frequency generation waveform
- R 3rd wire with rotation detector waveform
- U Upgrade
- GN RoHS compliance

## Sunon Connector recommendation

Connector pitch	Manufacturer	Housing	Terminal
1.25mm	HIROSE	DF13-2S-1.25C	DF13-2630SCF
	MOLEX	51021-0300	50058-8200
1.5mm	JST	ZHR-2	SZH-002T-P0.5 or SZH-003T-P0.5
2.0mm	JST	PHR-2	SPH-002T-P0.5S
2.54mm	ECI	2510-02	2511-P
	Molex	50-57-9405	16-02-0069(70058-0004) or 16-02-0082(70058-0006)
	Molex	2695-02RP	2759T(39-00-0372)
	Molex	2695-03RP	2759T(39-00-0372)
	Molex	6471-021	4809-C-P914
	Molex	6471-031	4809-C-P914
2.50mm	JAM	SC25-02HG	725462-2MA
	JST	SMR-02V-B	SYM-001T-P0.6
	JST	XHP-2	SXH-001T-0.6
	JST	EHR-2(H28J-2)	SEH-001T-P0.6
	JST	SMP-02V-BC	SHF-001T-0.8BS
	JWT	A2502H02-2P	A2502TOP-2
	JWT	A2502H02-3P	A2502TOP-2
	Molex	5051-02	2759T(39-00-0372)
	Molex	5264-02	5263PBT(08-70-1039)