



ALL RIGHTS RESERVED. NO PORTION OF THIS PUBLICATION, WHETHER IN WHOLE OR IN PART CAN BE REPRODUCED WITHOUT THE EXPRESS WRITTEN CONSENT OF SPC TECHNOLOGY.

SPC-F005.DWG

REVISIONS

DOC. NO. SPC-F005 * Effective: 7/8/02 * DCP No: 1398

DCP #	REV	DESCRIPTION	DRAWN	DATE	CHECKD	DATE	APPRVD	DATE
1403	A	RELEASED	JWM	1/23/03	HO	1/23/02	DJC	1/23/02

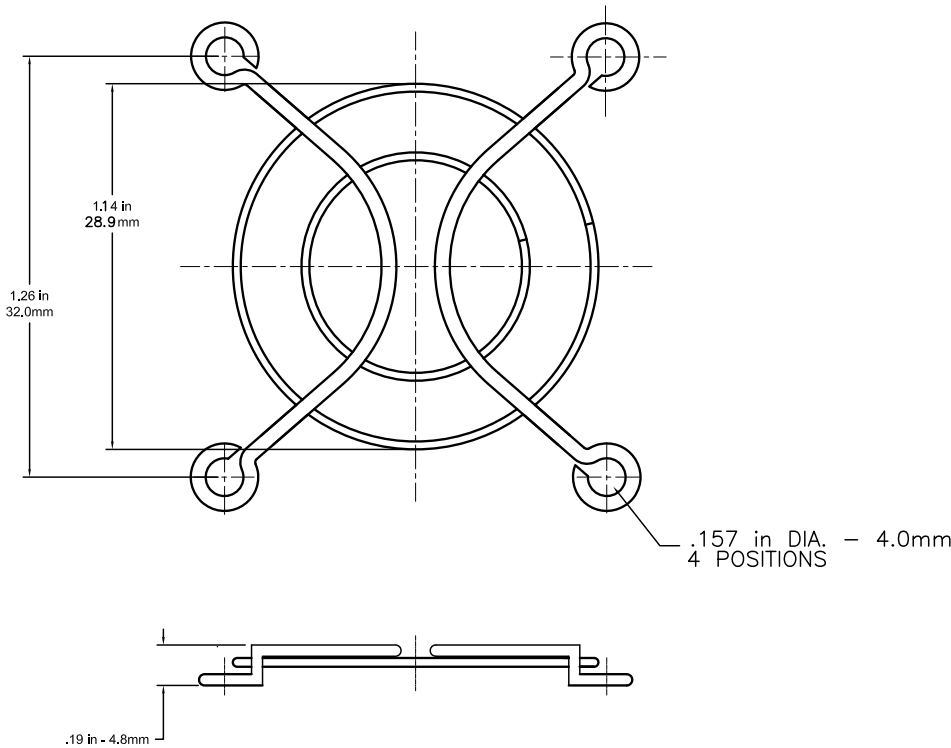

NOTES:

- Material: C1008 Steel
- Plating: Black Electro Deposit
- Ring Diameter: 1.6mm
- Rib Diameter: 1.6mm

DISCLAIMER:
ALL STATEMENTS AND TECHNICAL INFORMATION CONTAINED HEREIN ARE BASED UPON INFORMATION AND/OR TESTS WE BELIEVE TO BE ACCURATE AND RELIABLE. SINCE CONDITIONS OF USE ARE BEYOND OUR CONTROL, THE USER SHALL DETERMINE THE SUITABILITY OF THE PRODUCT FOR THE INTENDED USE AND ASSUME ALL RISK AND LIABILITY WHATSOEVER IN CONNECTION THEREWITH.

TOLERANCES:

UNLESS OTHERWISE SPECIFIED, DIMENSIONS ARE FOR REFERENCE PURPOSES ONLY.

DRAWN BY:	DATE:
Jeff McVicker	1/23/02
CHECKED BY:	DATE:
Hisham Odish	1/23/02
APPROVED BY:	DATE:
Daniel Carey	1/23/02

DRAWING TITLE:

Finger Guard

SIZE	DWG. NO.	ELECTRONIC FILE	REV
A	MC34242	32R8502.dwg	A
SCALE: NTS	U.O.M.: Millimeters	SHEET: 1 OF 1	