



PART NO.

MC06362-SS

REVISIONS

ECN #	REV	DESCRIPTION	DRAWN	DATE	CHECKD	DATE	APPRVD	DATE
-	A	RELEASED	Veena	20/11/08	Suresh	20/11/08	Farnell	04/12/08

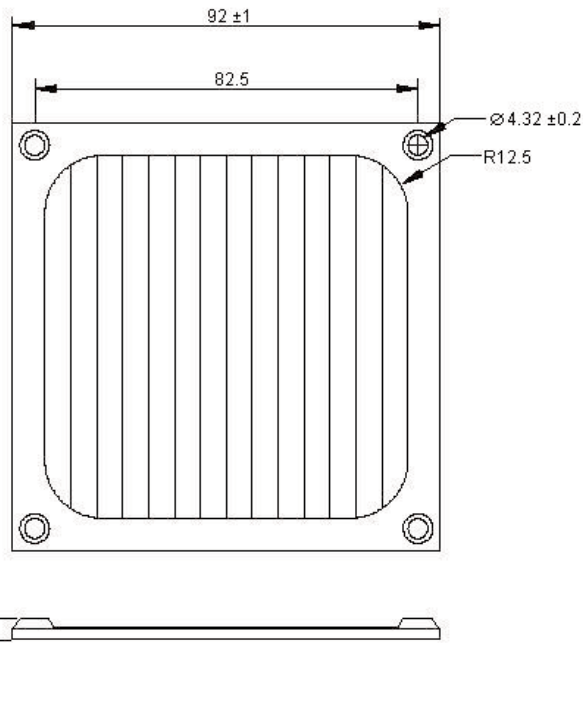

Dimensions : Millimetres

Specifications:

Material:

Frame : SUS304 stainless steel with 0.6mm thickness.

Mesh : 24#/25.4mm stainless steel.

Finish : Electrolyze.



Part Number Table

Description	Part Number
EMC Screen, 92mm, Stainless Steel	MC06362-SS

<http://www.farnell.com>

<http://www.newark.com>

<http://www.cpc.co.uk>

This data sheet and its contents (the "Information") belong to the Premier Farnell Group (the "Group") or are licensed to it. No licence is granted for the use of it other than for information purposes in connection with the products to which it relates. No licence of any intellectual property rights is granted. The Information is subject to change without notice and replaces all data sheets previously supplied. The Information supplied is believed to be accurate but the Group assumes no responsibility for its accuracy or completeness, any error in or omission from it or for any use made of it. Users of this data sheet should check for themselves the Information and the suitability of the products for their purpose and not make any assumptions based on information included or omitted. Liability for loss or damage resulting from any reliance on the Information or use of it (including liability resulting from negligence or where the Group was aware of the possibility of such loss or damage arising) is excluded. This will not operate to limit or restrict the Group's liability for death or personal injury resulting from its negligence. SPC MULTICOMP is the registered trademark of the Group. © Premier Farnell plc 2008.

TOLERANCES:

UNLESS OTHERWISE SPECIFIED, DIMENSIONS ARE FOR REFERENCE PURPOSES ONLY.

DRAWN BY:	DATE:
Veena	20/11/08
CHECKED BY:	DATE:
Suresh	20/11/08
APPROVED BY:	DATE:
Farnell	04/12/08

DRAWING TITLE:

EMC Screen - 92mm, Stainless Steel

SIZE A	DWG NO. M10001833	ELECTRONIC FILE 06362-ss_DWG	REV A
SCALE: NTS	U.O.M.: mm	SHEET: 1 OF 1	