

**RoHS Compliant
Pb - Lead Free**

Ltr	Revisions	Date	Appr

Electrical Specifications:

Nominal Frequency	6.000	MHz
Mode of Oscillation	Fundamental	-
Frequency Tolerance at 25°C	±30	PPM Max
Frequency Stability over Temperature Range	±50	
Operating Temperature Range (Extended)	-40 to +85	° C
Storage Temperature Range	-55 to +125	
Aging per Year	±3	PPM Max
Load Capacitance	18	pF
Shunt Capacitance (Maximum)	7	
Equivalent Series Resistance (ESR)	80	Ohms Max
Drive Level	100 Typ - 500 Max	uW
Solder Reflow Characteristics	+260 for 10 s Max	° C

Mechanical Specifications:

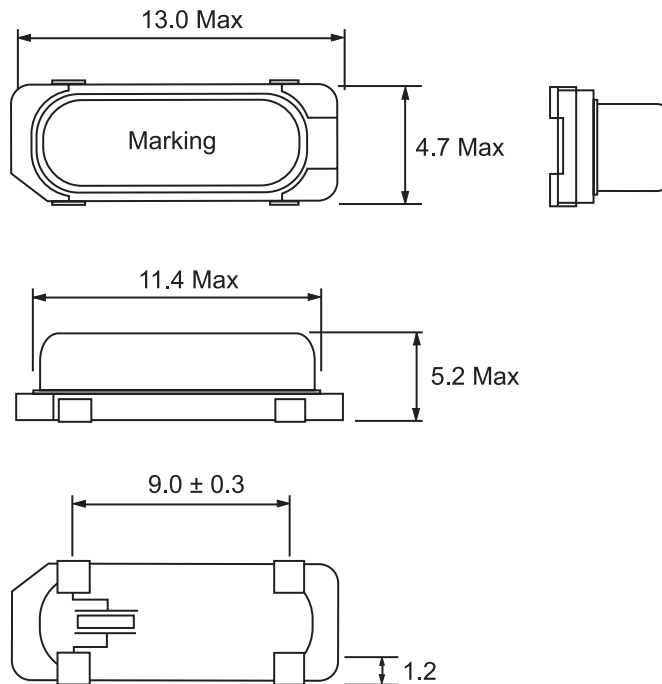

11-3 Chien-Kuo Rd T.E.P.Z. 4027 Taiwan, ROC

All dimensions are millimeters.

CAD: TR

Review: SL

Appr: AL

Page: 1/1 | Date: Jan. 16, 2008

Specification Title:

**Quartz Crystal Unit
HC-49/U-S-SMD - 4 Pad
Product Specification
Farnell Order Code: 1538787**

Part Number: **CA4-6.000-18-3050-X**