

Infiniium Series Oscilloscope Probes, Accessories, and Options

Selection Guide Data Sheet

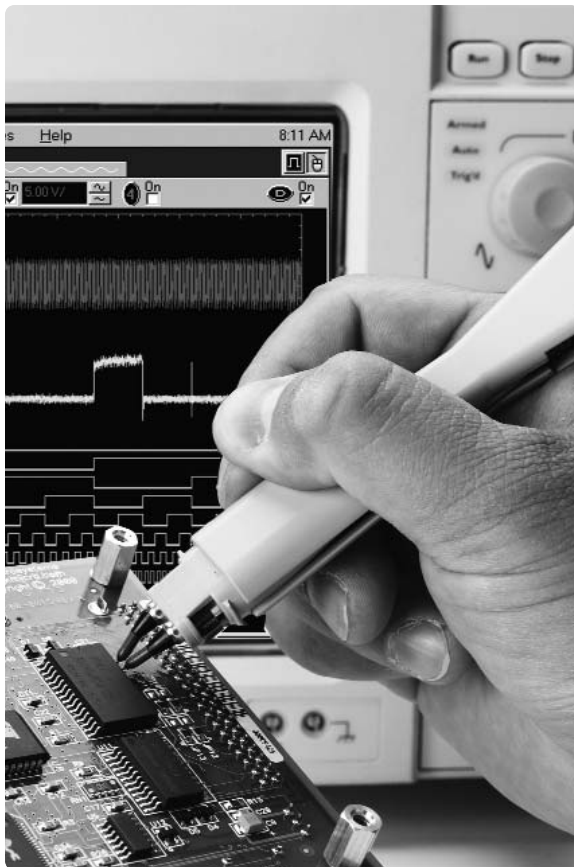

To ensure that you have the tools for dependable oscilloscope measurements, Agilent Technologies offers a wide range of oscilloscope probes and accessories. Each is designed for a specific measurement need because the physical and electrical quality of the connection can make the difference between a good measurement and a bad one.

Table of Contents

| | |
|---|-----------|
| Probe Compatibility Table | 2 |
| General Purpose Probes Overview | 3 |
| 1007XC Family Passive Probes | 4 |
| 116XA Family Passive Voltage | 6 |
| 117XA Family Low Mass, Passive Voltage..... | 9 |
| High-Frequency Voltage Probes Overview | 11 |
| 1130A/31A/32A/34A InfiniiMax High-Performance Active Probe System..... | 12 |
| 1168A/69A InfiniiMax II High-Performance Active Probe System..... | 15 |
| 1155A Active Single-Ended Voltage..... | 18 |
| 1156A/57A/58A High-Bandwidth, Active Voltage | 20 |
| 1163A Resistive Divider..... | 6 |
| 54006A Resistor Divider Probe | 23 |
| Differential Voltage Probes Overview | 24 |
| 1130A/31A/32A/34A InfiniiMax High-Performance Active Probe System..... | 12 |
| 1168A/69A InfiniiMax II High-Performance Active Probe System..... | 15 |
| 1153A Low-Bandwidth Active Differential Voltage | 25 |
| Current Probes Overview..... | 28 |
| 1146A ac/dc Current | 29 |
| 1147A High Bandwidth ac/dc Current | 31 |
| High-Voltage Passive Probes Overview | 33 |
| 10076A (100:1)..... | 34 |
| N2771A (1000:1)..... | 35 |
| Mixed-Signal Oscilloscope Logic Probe Kit..... | 36 |
| E5396A Half-Size Soft Touch Connectorless Logic Probe | 37 |
| Probing Accessories..... | 38 |
| Wedge Adapters..... | 38 |
| 0.5 mm IC Clips, PC Board Mini-Probe Sockets | 39 |
| EZ-Probe Positioner | 40 |
| Logic Analyzer/Oscilloscope Time Correlation | 41 |
| VoiceControl | 42 |
| Input Devices and Storage Devices..... | 43 |
| E2610A Keyboard, E2609B Rackmount Kit, 1184A Testmobile | 43 |
| Infiniium Advanced Analysis Options | 44 |



Agilent Technologies

Probe Compatibility Table

For ordering information when replacing your probe or probe accessory:

Refer directly to the page number listed in the table of contents for your probe model.

To assist you in selecting the proper probe for your application:

Use our probe compatibility table below to find the probes that are recommended for use with your Infiniium scope.

Or refer to our probe overview page at the beginning of each section in the table of contents explaining what the different probe types are and the models available for your Infiniium.

| Probe Type | Probe Model | 54830B/31B/32B/33A/ 30D/31D/32D/33D and 8000 Series | 54835A/45A/ 45B/46A/46B | 54810A/15A/ 20A/25A | 54852A/53A/54A/55A and DS080000 Series |
|--|----------------------|---|----------------------------|------------------------|---|
| General Purpose Passive Page 4, 6 | 1160A, 10:1 500 MHz | Incompatible | Incompatible | Recommended | Incompatible |
| | 1161A, 10:1 500 MHz | Compatible | Recommended | Incompatible | Compatible [1] |
| | 1162A, 1:1 25 MHz | Recommended | Recommended | Recommended | Compatible [1] |
| | 1165A, 10:1 600 MHz | Recommended | Compatible | Incompatible | Incompatible |
| | 10070C, 1:1 20 MHz | Recommended | Compatible | Compatible | Compatible [1] |
| | 10073C, 10:1 500 MHz | Recommended | Compatible | Incompatible | Recommended [1] |
| Low Mass Passive Page 9 | 1171A, 10:1 | Recommended | Recommended | Incompatible | Compatible [1] |
| Active Single-Ended Page 18, 20 | 1155A, 750 MHz | Recommended | Compatible | Recommended | Compatible |
| | 1156A, 1.5 GHz | Recommended | Recommended | Recommended | Compatible |
| | 1157A, 2.5 GHz | Compatible | Recommended | Compatible | Compatible |
| | 1158A, 4 GHz | Compatible | Recommended | Compatible | Compatible |
| Resistive Divider Page 6, 23 | 1163A, 10:1 | Recommended | Recommended | Recommended | Incompatible |
| | 54006A, 10:1 or 20:1 | Compatible [2] | Recommended [2] | Compatible [2] | Recommended [2] |
| Active Differential Page 12, 15, 25 | 1153A, 200 MHz | Recommended | Recommended | Recommended | Compatible |
| | 1130A, 1.5 GHz [6] | Recommended [3] | Compatible | Incompatible | Compatible |
| | 1131A, 3.5 GHz [6] | Recommended [3] | Recommended [4] | Incompatible | Recommended |
| | 1132A, 5 GHz [6] | Compatible [3] | Compatible [4] | Incompatible | Recommended |
| | 1134A, 7 GHz [6] | Compatible [3] | Compatible [4] | Incompatible | Recommended |
| | 1168A, 10 GHz [6] | Compatible [8] | Incompatible | Incompatible | Recommended [8] |
| Current Page 29, 31 | 1146A, 100 kHz | Recommended | Recommended | Recommended | Compatible [1] |
| | 1147A, 50 MHz | Recommended | Recommended | Recommended | Incompatible [7] |
| High Voltage Page 34, 35 | 10076A, 4 kV | Recommended | Recommended | Recommended | Compatible [1] |
| | N2771A, 15 kV | Recommended | Recommended | Recommended | Compatible [1] |
| Mixed-Signal Oscilloscope Logic Probe Kit Page 36 | 54826-68701 | Recommended [5] | Incompatible | Incompatible | Incompatible |
| Half-Size Soft Touch Connectorless Logic Probe Page 37 | E5396A | Recommended [5] | Incompatible | Incompatible | Incompatible |

[1] Requires E2697A 1 M Ω input adapter. The E2697A includes one 10073C general-purpose 500 MHz, 10:1 passive probe.

[2] Requires 54855-67604 SMA-BNC adapter.

[3] Requires 54830 Series system software revision A.03.10 or higher. For A.02.xx or lower, order N5383A to upgrade system software.

[4] Requires 54845/46 system software revision A.04.50 or higher.

[5] Recommended for MS08064A, MS08104A, and 54830D/31D/32D/33D mixed signal oscilloscopes only.

[6] Each 113XA and 1168A/9A probe amplifier supports both single-ended and differential measurements.

[7] Order N2774A 50 MHz current probe with N2775A power supply that also requires the E2697A 1 M Ω input adapter.

[8] Requires 54830 Series, 54850 Series, DS080000 Series system software revision A.03.90 or higher. For A.02.xx or lower, order N5383A to upgrade system software.

General Purpose Probes Overview

Passive voltage probes are used for general purpose probing and are made with passive components only such as wires, connectors, capacitors and resistors (when attenuation is required). There are no active components such as transistors or amplifiers in the probe, and therefore passive voltage probes do not need to be powered.

General purpose probes are available with attenuation ratios of 1:1, 10:1, and 20:1. The 10:1 passive voltage probe is the most commonly used probe, and is supplied as a standard accessory with all Infiniium 8000 Series oscilloscopes.



Figure 2.1. Agilent 1007XC general purpose passive probe.



Figure 2.2. Agilent 116XA general purpose passive probe.

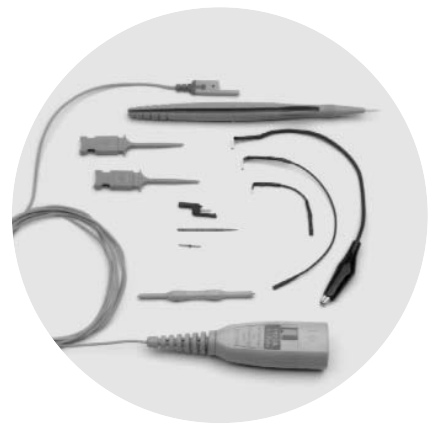

Figure 2.3. Agilent 117XA low mass probe for fine-pitched ICs, SMDs, and dense circuit boards.

| Model | Probe Type | Applications and Use | Page |
|------------------------------------|-----------------|---|------|
| 1007XC Family | Passive voltage | General purpose | 4 |
| 116XA Family (excluding the 1163A) | Passive voltage | General purpose, small probe tip | 6 |
| 117XA Family | Passive voltage | Fine-pitched ICs, surface mount devices, and dense circuit boards | 9 |

Passive Voltage Probe Advantages

1007XC are very rugged, low cost, easy to use, high high dynamic range and high input resistance

116XA are economical, small in size, have high dynamic range and high input resistance

117XA feature low mass, low weight, low tip capacitance compared to other passive probes

Limitations

500 MHz maximum bandwidth
Higher capacitive loading than active probes

600 MHz maximum bandwidth
Higher capacitive loading than active probes
Less rugged compared to 1007XC

500 MHz bandwidth

General Purpose Probes Overview

Agilent 1007XC Family Passive Voltage

- **Very rugged design**
- **Low cost**
- **1:1 and 10:1**

Rugged, high-quality probes at an affordable price

Agilent 10070-family passive probes are a great choice if you're looking for high quality at an affordable price. These general purpose probes are the standard passive probes designed for the Infiniium 8000 Series oscilloscopes. Ruggedized for general-purpose measurements, they feature a durable cable and a solid stainless steel probe body encased with a hard, fracture-resistant plastic. They're designed and tested to ensure the probes operate in the toughest of conditions. The 1007XC family probes are compatible with the AutoProbe interface, which completely configures the Infiniium oscilloscopes for the probe. General purpose probes are available with attenuation ratios of 1:1, and 10:1 The 10:1 passive voltage probe is the most commonly used probe, and is supplied as a standard accessory with all Infiniium 8000 Series oscilloscopes.

Standard accessories included:

- General-purpose retractable hook tip hooks onto wires and test points for hands-free probing
- Ground bayonet provides short, flexible ground lead for high-frequency measurements
- General-purpose alligator clip ground lead for versatile grounding
- Color tags (2 orange, 2 white, 2 blue and 2 green) to place at both ends of probe cable to help you quickly identify probes

Optional accessories available:

10072A

Fine-pitch probing kit includes 10 SMT clips and 2 dual-lead adapters

10075A

0.5 mm IC probing kit includes four 0.5 mm IC clips and 2 dual-lead adapters

5081-7705

Probe-tip-to-BNC (m) adapter

8710-2063

Dual-lead adapter provides easy connection from probe signal and ground to fine-pitch probing accessories

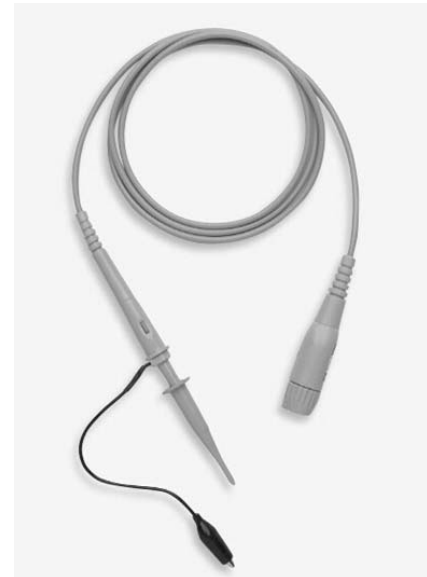

Figure 2.4. Agilent Agilent 1007XC Family general purpose probe.

Specifications

| Model Number | Type of Probe | System Bandwidth (scope+probe) | Division Ratio | Input R | Input C | Scope Input R | Compensation Range | Length |
|--------------|------------------------|--------------------------------|----------------|---------|---------|---------------|--------------------|--------|
| 10070C | High Impedance Passive | 20 MHz | 1:1 | 1 MΩ | 70 pF | 1 MΩ | n/a | 1.5 m |
| 10073C | High Impedance Passive | 500 MHz | 10:1 | 2.2 MΩ | 12 pF | 1 MΩ | 6-15 pF | 1.5 m |

General Purpose Probes Overview

Agilent 1007XC Family Passive Voltage

Specifications

Operating Characteristics

| | |
|-------------------------------|-------------------------------------|
| Approximate propagation delay | 7 ns |
| Maximum input voltage | 10070C: 400 V (dc + peak ac), CAT I |
| | 10073C: 500 V (dc + peak ac), CAT I |

Environmental Characteristics

| | |
|-------------------------|--------------------------------------|
| Temperature (operating) | -10° C to +55° C |
| Humidity (operating) | Up to 90% relative humidity at 40° C |
| Altitude (operating) | Up to 4,600 meters (15,000 ft.) |
| Shock | 50 g (400 g tip only) |

Ordering Information

Probes and Accessories

| Part # | Description | Quantity |
|-----------|--|----------|
| 10070C | 1:1, 1 M Ω , 1.5 m passive probe | 1 |
| 10073C | 10:1, 2.2 M Ω 1.5 m passive probe | 1 |
| 10072A | Fine-pitch probing kit with 2 dual-lead adapters | 1 |
| 10075A | 0.5 mm IC probing kit with 2 dual-lead adapters | 1 |
| 5081-7705 | Probe-tip-to-BNC (m) adapter | 1 |
| 8710-2063 | Dual-lead adapter | 1 |

Probe Parts Supplied

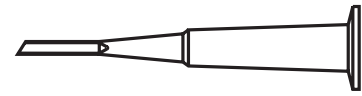

One retractable hook tip



One adjustment tool

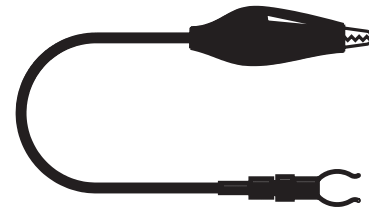

One alligator ground lead



One ground bayonet



One IC tip



Eight identification tags

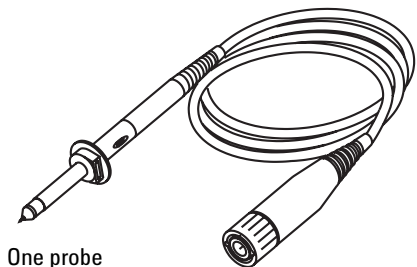

One probe

General Purpose Probes

Agilent 116XA Family Passive Voltage

- **Economical, easy to use**
- **Compact design, removable probe handle for tight probing areas**
- **Agilent 1163A, 500 Ω resistive divider, 10:1 attenuation**

Built for Reliability

These general purpose replacement devices are built and tested for high reliability. Kevlar strengthener has been added to the probe cable for extra pull strength. Durable probe tips are replaceable.

The compact design significantly reduces the problem of probing densely populated integrated circuit components or the characteristically minute conductors on printed circuit boards. These small lightweight probes allow measurements that were previously quite difficult, while reducing the danger of shorting. For tight probing areas, the probe handle can be unscrewed and pulled back along the cable.

When probing about the circuit in debug mode, the probes easily slip inside the included browsers. The browsers feature a crown

point that digs into solder and avoids the danger of slipping off the test point and shorting to adjacent leads. A pogo pin allows hand movement on the probes without losing contact with the device under test.

The 116XA family probes are compatible with the AutoProbe interface, which completely configures the Infiniium oscilloscope for the probe. A snap-on BNC connector simplifies attaching the probe to the scope. Leads are

available for connecting to a wide variety of test points. See "Ordering Information" for a complete list.

Agilent 1163A Resistive Divider

Agilent 1163A features low capacitive loading and wide bandwidth, resulting in very accurate timing measurements. Resistive divider probes are useful for probing low-voltage signals such as ECL circuits, 50 Ω transmission lines, and GaAs circuits.

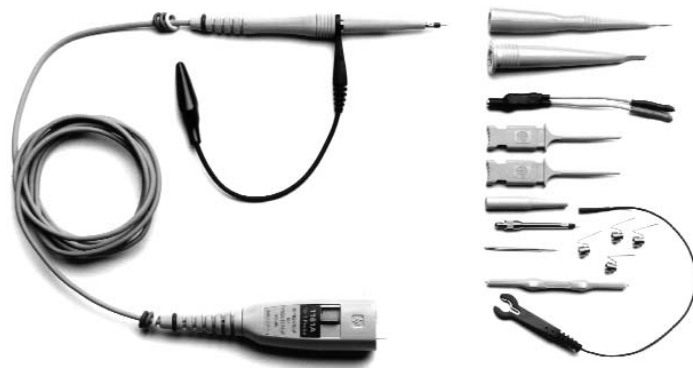

Figure 2.5. Agilent 116XA family general purpose replacement probes.



Figure 2.6. No-slip browser crown point.

General Purpose Probes

Agilent 116XA Family Passive Voltage

Specifications

| Model Number | Type of Probe | System Bandwidth (scope + probe) | Division Ratio | Input R | Input C | Scope Input R | Compensation Range | Length |
|--------------|--------------------------------|--|----------------|---------------|---------------------------|---------------|--------------------|--------|
| 1160A | High Impedance, Passive | 500 MHz | 10:1 | 10 M Ω | 9 pF | 1 M Ω | 6 - 9 pF | 1.5 m |
| 1161A | High Impedance, Passive | 500 MHz | 10:1 | 10 M Ω | 10 pF | 1 M Ω | 12 - 14 pF | 1.5 m |
| 1162A | High Impedance, Passive | 25 MHz | 1:1 | 1 M Ω | 50 pF + scope capacitance | 1 M Ω | n/a | 1.5 m |
| 1163A | 500 Ω Resistive Divider | 1.5 GHz with scope model 54845A/B | 10:1 | 500 Ω | 1.5 pF | 50 Ω | n/a | 1.5 m |
| 1165A | High Impedance, Passive | 600 MHz typical with 54830B/31B/32B/33A 54830D/31D/32D/33D | 10:1 | 10 M Ω | 10 pF | 1 M Ω | 12 - 14 pF | 1.5 m |

Operating Characteristics

| | |
|----------------------------------|---|
| Approximate propagation delay | 6.7 ns for 1160A/61A/62A/63A/65A probes 8.8 ns for 1164A probe |
| Maximum input voltage | 300 V (dc + peak ac), CAT II 10 V (dc + peak ac), CAT I for 1163A only |
| Safety | Meets IEC1010-2-31 |
| Pulling strength (BNC to barrel) | \leq 12 lb static pull |
| Net weight | 2.6 oz |

Environmental Characteristics

| | |
|-------------------------|--------------------------------------|
| Temperature (operating) | 0° C to +55° C |
| Humidity (operating) | Up to 95% relative humidity at 40° C |
| Altitude (operating) | Up to 4,600 meters (15,000 ft.) |
| Shock | 50 g (400 g tip only) |

General Purpose Probes

Agilent 116XA Family Passive Voltage

Ordering Information

Probes and Accessories

| Part # | Description | Quantity |
|-----------|---|----------|
| 1160A | 10:1, 10 M Ω , 1.5 m, miniature passive probe | 1 |
| 1161A | 10:1, 10 M Ω , 1.5 m, miniature passive probe | 1 |
| 1162A | 1:1, 1.5 m, miniature passive probe | 1 |
| 1163A | 10:1, 500 Ω , low C, 1.5 m, miniature passive probe | 1 |
| 1165A | 10:1, 10 M Ω , 1.5 m, miniature passive probe | 1 |
| 5063-2143 | Probe tip to BNC (m) | 1 |
| | IC clips: See "Probing Accessories" | |
| | Horizontal and vertical mini-probe sockets: See "Probing Accessories" | |
| | Wedge Probe Adapters: See "Probing Accessories" | |

Replacement Parts

| Part # | Description | Quantity |
|-------------|---|----------|
| 5063-2135 | General purpose retractable hook tip | 2 |
| 5063-2140 | Alligator ground lead | 2 |
| 5063-2120 | Socketed ground lead | 1 |
| 5063-2115 | Browser | 1 |
| 5063-2147 | Dual lead adapter | 1 |
| 5063-2149 | SMD clips | 5 |
| 01160-68701 | Accessory kit (includes four spring grounds, four browser pogo pins, four barrel insulators, one screwdriver) | 1 |
| 5063-2136 | 1160A probe tip, red | 5 |
| 5063-2137 | 1161A probe tip, brown | 5 |
| 5063-2138 | 1162A probe tip, black | 5 |
| 5063-2139 | 1163A probe tip, grey | 5 |
| 5063-2151 | 1164A probe tip, orange | 5 |
| 5063-2137 | 1165A probe tip, brown | 5 |

Probe Parts Supplied

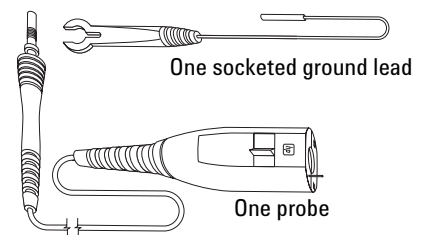
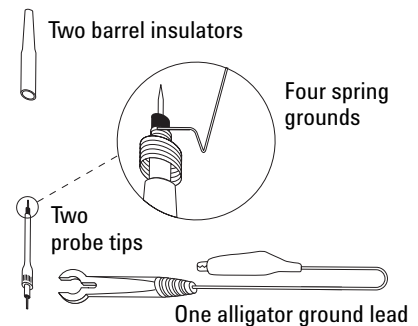
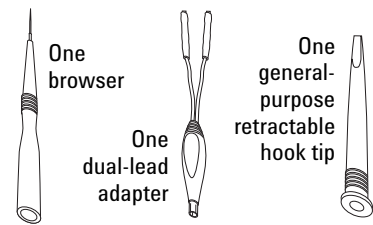
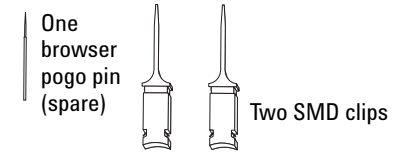

Includes user's guide and three-year warranty.

General Purpose Probes

Agilent 117XA Family Low Mass, Passive Voltage

- **Easy connection to fine-pitch ICs, SMDs, and dense circuit boards**
- **Light weight (< 1 gram), low mass probe tip**
- **10:1 attenuation, capacitance < 10 pF (1171A)**

Suited for Today's ICs

An exceptionally small and light probe tip (<1 gram) and an ultra thin cable make the 117XA family ideal for connecting to and probing fine-pitch ICs, surface mount devices, and dense circuit boards.

The probe fits directly onto standard board headers and IC clips. A range of accessories are available for you to optimize interfacing with surface mount devices. Wedge Probe Adapters make convenient and reliable connections to TQFP/PQFP package leads. See "Ordering Information" for a complete list of accessories.

When probing about the circuit in debug mode, the probe easily slips inside the included browsers. The browsers feature a crown point that digs into solder and avoids the danger of slipping off the test point and shorting to adjacent leads. A pogo pin allows hand movement on the probes without losing contact with the device under test.

The 117XA probes are compatible with the AutoProbe interface, which completely configures the Infiniium oscilloscope for the probe. A snap-on BNC connector simplifies attaching the probe to the scope.



Figure 2.7. Agilent 117XA family probes for fine-pitch ICs, surface mount devices, and dense circuit boards.

Specifications

| Model Number | Type of Probe | System Bandwidth (scope + probe) | Division Ratio | Input R | Input C | Scope Input R | Compensation Range | Length |
|--------------|-------------------------|----------------------------------|----------------|---------|---------|---------------|--------------------|--------|
| 1171A | High Impedance, Passive | 500 MHz | 10:1 | 10 MΩ | 10 pF | 1 MΩ | 12 - 14 pF | 1.4 m |

General Purpose Probes

Agilent 117XA Family Low Mass, Passive Voltage

Specifications

Operating Characteristics

| | |
|-------------------------------------|----------------------------|
| Approximate propagation delay | 1171A: 6.5 ns |
| Maximum input voltage | 40 V (dc + peak ac), CAT I |
| Safety | Meets IEC1010-2-31 |
| Pulling strength (BNC to probe tip) | ≤ 12 lb static pull |
| Net weight | 2.6 oz |
| Probe tip weight | < 1 gram |

Environmental Characteristics

| | |
|-------------------------|--------------------------------------|
| Temperature (operating) | 0° C to +55° C |
| Humidity (operating) | Up to 95% relative humidity at 40° C |
| Altitude (operating) | Up to 4,600 meters (15,000 ft.) |
| Shock | 50 g (400 g tip only) |

Ordering Information

Probes and Accessories

| Part # | Description | Quantity |
|--------|---|----------|
| 1171A | 10:1, 10 MΩ, 1.4 m, low mass passive probe | 1 |
| | IC clips: See "Probing Accessories" | |
| | Wedge Probe Adapters: See "Probing Accessories" | |

Replacement Parts

| Part # | Description | Quantity |
|-----------|-------------|----------|
| 5063-2122 | Browser | 1 |

Probe Parts Supplied

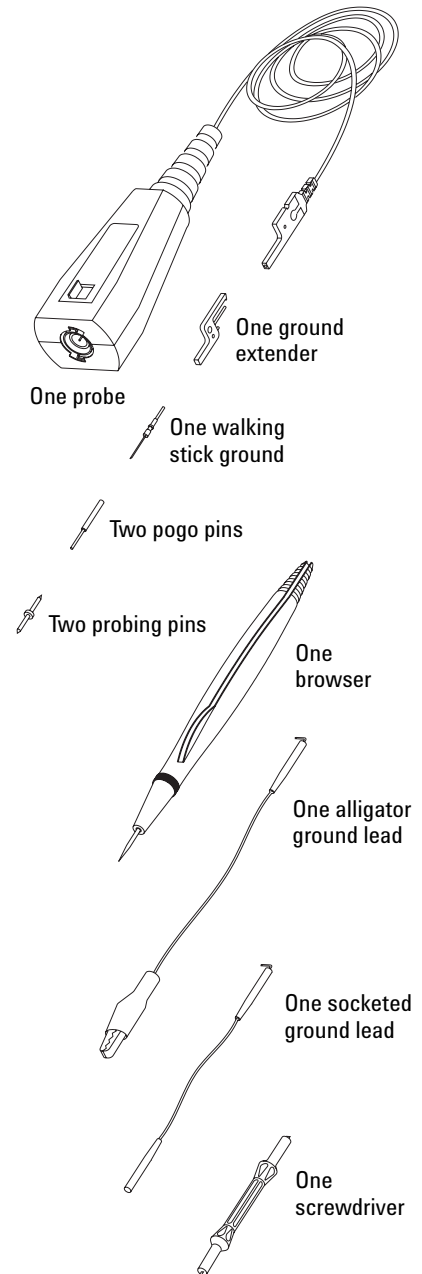

Includes two IC clips, user's guide, and one-year warranty.

High-Frequency Voltage Probes Overview

Active voltage probes contain an active component, usually a field-effect transistor (FET), and therefore need to be powered. A FET input has the advantage of providing a very low input capacitance, typically from less than 1 pF to a few pF. This low capacitance results in a high input impedance on frequencies up to 7 GHz. With such low loading, active probes can be used on high-impedance circuits that would be seriously loaded by passive probes.

New InfiniiMax probe family. The innovative InfiniiMax probe system provides either differential or single-ended probing solutions for the most demanding connection requirements, without sacrificing performance.

Resistive divider probes are passive probes. They feature low capacitive loading and accurate timing measurements with high-bandwidth signals at a much lower cost than active probes.

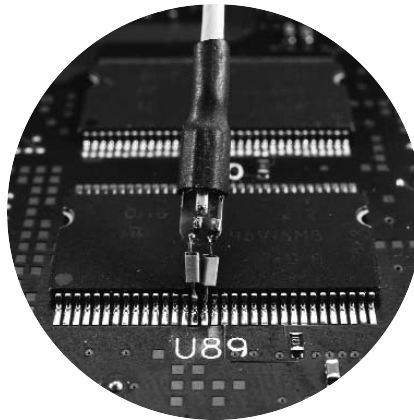

Figure 3.1. Agilent 1130A/31A/32A/34A InfiniiMax high-performance active probe.

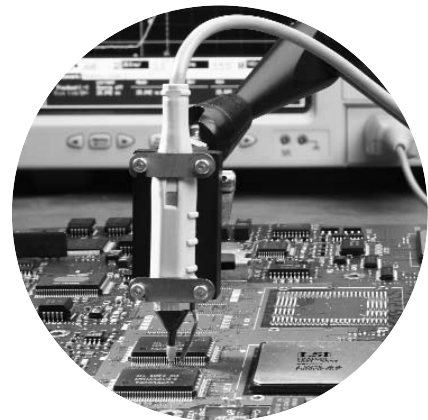

Figure 3.2. Agilent 1156A/57A/58A active probes for signals up to 4 GHz.

| Model | Probe Type | Applications and Use | Page |
|-------------------|---------------------|---|------|
| 1130A/31A/32A/34A | Active Diff/SE | Measure both differential and single-ended signals up to 7 GHz | 12 |
| 1168A/69A | Active Diff/SE | Measure both differential and single-ended signals up to 13 GHz | 15 |
| 1155A | Active Single-Ended | Measure fast transitions on low-voltage signals, 2 channels | 18 |
| 1156A/57A/58A | Active Single-Ended | Measure fast transitions on low-voltage signals up to 4 GHz | 20 |
| 1163A | Resistive divider | Measure fast transitions on a wide range of signal voltages | 6 |
| 54006A | Resistive divider | Low-cost alternative for high-frequency probing | 23 |

High-Frequency Probe Advantages

Limitations

Timing and voltage measurements more accurate at high bandwidths

Active probes are more expensive than general purpose passive probes

Resistive divider probes cost less than active probes

Relatively heavy resistive loading with resistive divider probes

Active probes are least intrusive to circuit under test, high input resistance

Active probes have lower dynamic range, lower maximum voltage and are less rugged compared to passive probes

High-Frequency Active Differential/Single-Ended Probe System

Agilent 1130A/31A/32A/34A InfiniiMax High-Performance Active Probe System

- **InfiniiMax 7 GHz, 5 GHz, 3.5 GHz, and 1.5 GHz probing system**
- **Each InfiniiMax probe amplifier supports both differential and single-ended measurements for a more cost-effective solution**
- **Unrivaled InfiniiMax probing accessories support browsing, solder-in, and socket use models at the maximum performance available**

The Agilent InfiniiMax 1134A, 1132A, 1131A and 1130A probe systems provide 7 GHz, 5 GHz, 3.5 GHz and 1.5 GHz of bandwidth respectively, and offer the following benefits:

- The new probes have a **flat frequency response over the entire bandwidth specification**, eliminating the distortion and loading that affect probes with in-band resonance. The probing system enables engineers to utilize their oscilloscope's entire bandwidth without being limited to measuring only 50 Ω transmission lines or using passive resistive divider probes that produce voltage measurement error and circuit loading. Designers can achieve system measurement bandwidths of 4.5 to 6 GHz even when manually "browsing" with the probe. Solder-in probe heads and solder-in sockets provide even higher bandwidths.

- The Agilent InfiniiMax 1130A series probe system supports **a wide variety of real-world applications with an extensive line up of probe heads and accessories**. The accessories can meet the most demanding mechanical access requirements. Small probe heads can be placed between densely packed PC boards. Solder-in sockets are available for signals that need frequent measurement. A differential SMA probe head is available to connect to fixtures that have SMA connections. A smart ergonomic design allows users to set the spacing between the probe pins (variable span). When not concerned with minimum probe size, designers can use a browsing sleeve to make holding the probe more comfortable. Both probe tips of the differential probe can "flex" to support various probing angles and target system characteristics (z-axis compliance). Innovative damped-wire accessories compensate for the inductance and capacitance associated with the leads, and prevent distortion of the measured signal.

- The groundbreaking design of Agilent InfiniiMax 1130A probe system also enables users to make **either single-ended or differential measurements from a single probe amplifier**, depending on their choice of probe head and accessory. This can result in significant savings in cost and time. The common mode rejection of the differential probe head reduces a measurement's noise floor. Overall, the Agilent 1130 series probing system delivers unmatched performance, accuracy and connectivity.

InfiniiMax: The World's Best High-Speed Oscilloscope Probing System

EDN Magazine has awarded Agilent's InfiniiMax active probe system the 2002 Innovation of the Year Award.

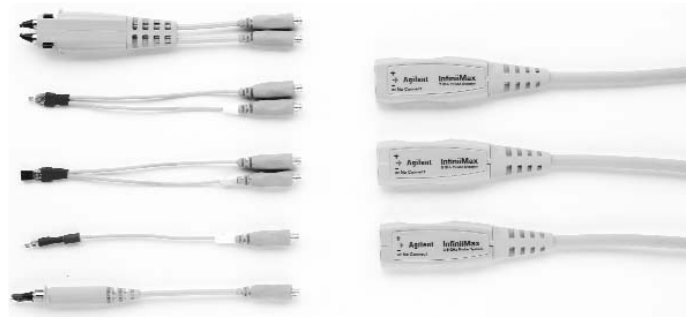

Figure 3.3. InfiniiMax offers you the highest performance available for measuring differential and single-ended signals.

High-Frequency Active Differential/Single-Ended Probe System

Agilent 1130A/31A/32A/34A InfiniMax High-Performance Active Probe System

Specifications

Operating Characteristics

| | |
|-------------------------------------|---|
| Probe bandwidth* | 1134A: > 7 GHz 1132A: > 5 GHz 1131A: > 3.5 GHz 1130A: > 1.5 GHz |
| Rise and fall time (10% to 90%) | 1134A: 60 psec 1132A: 86 psec 1131A: 100 psec 1130A: 233 psec |
| System bandwidth (-3 dB) | 1134A with 54855A: 6 GHz 1132A with 54854A: 4 GHz 1131A with 54853A: 2.5 GHz 1131A with 54852A: 2 GHz 1130A with MSO/DSO8104A, 54832B/D, 33A/D: 1 GHz |
| Input capacitance** | $C_m = 0.1 \text{ pF}$ C_m is between tips. $C_g = 0.34 \text{ pF}$ C_g is to ground for each tip. $C_{diff} = 0.27 \text{ pF}$ Differential mode capacitance = $C_m + C_g/2$ $C_{se} = 0.44 \text{ pF}$ Single-ended mode capacitance = $C_m + C_g$ |
| Input resistance* | Differential mode resistance = $50 \text{ k}\Omega \pm 1\%$ Single-ended mode resistance = $25 \text{ k}\Omega \pm 1\%$ |
| Input dynamic range | $\pm 2.5 \text{ V}$ |
| Input common mode range | $\pm 6.75 \text{ V}$ dc to 100 Hz; $\pm 1.25 \text{ V}$ >100 Hz |
| Maximum signal slew rate | 18 V/ns when probing a single-ended signal 30 V/ns when probing a differential signal |
| DC attenuation | 10:1 $\pm 3\%$ before calibration on oscilloscope 10:1 $\pm 1\%$ after calibration on oscilloscope |
| Zero offset error referred to input | < 30 mV before calibration on oscilloscope < 5 mV after calibration on oscilloscope |
| Offset range* | $\pm 12.0 \text{ V}$ when probing single-ended |
| Offset accuracy | < 3 % setting before calibration on oscilloscope < 1 % setting after calibration on oscilloscope |
| Noise referred to input | 3.0 mVrms |
| Propagation delay | ~6 nsec (This delay can be deskewed relative to other signals.) |
| Maximum input voltage* | 30 Vpeak, CAT I |
| ESD tolerance | > 8 kV from 100 pF, 300 Ω HBM |

* Denotes warranted specifications, all others are typical.

** Measured using the probe amplifier and solder-in differential probe head with full bandwidth resistors.

Example of characterized performance plots: differential solder-in probe head

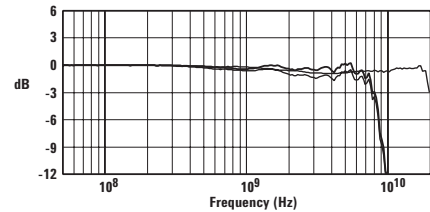

Figure 3.4. Swept frequency response.

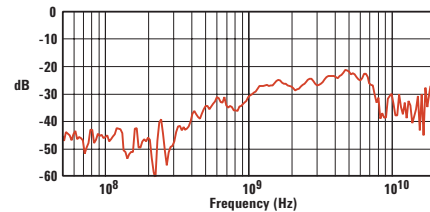

Figure 3.5. Common mode rejection vs. frequency.

High-Frequency Active Differential/Single-Ended Probe System

Agilent 1130A/31A/32A/34A InfiniiMax High-Performance Active Probe System

Ordering Information

Probe Amplifier Model

| Part # | Description | Quantity |
|--------|--|----------|
| 1134A | 7 GHz InfiniiMax Probe Amplifier (order one or more probe heads or connectivity kits per amplifier). | 1 |
| 1132A | 5 GHz InfiniiMax Probe Amplifier (order one or more probe heads or connectivity kits per amplifier). | 1 |
| 1131A | 3.5 GHz InfiniiMax Probe Amplifier (order one or more probe heads or connectivity kits per amplifier). | 1 |
| 1130A* | 1.5 GHz InfiniiMax Probe Amplifier (order one or more probe heads or connectivity kits per amplifier). | 1 |

* Note: Requires 54830 Series system software revision A.03.10 or higher. For A.02.xx or lower, order N5383A to upgrade system software.

Connectivity Kits Model

| Part # | Description | Quantity |
|--------|---|----------|
| E2669A | InfiniiMax connectivity kit for differential/single-ended measurements. Includes one differential browser, four solder-in differential probe heads and two socketed differential probe heads. Includes all necessary accessories. | 1 |
| E2668A | InfiniiMax connectivity kit for single-ended measurements. Includes one single-ended browser, one solder-in probe heads and one socketed probe heads. Includes all necessary accessories. | 1 |

Individual Probe Heads

| Part # | Description | Quantity |
|--------|--|----------|
| E2675A | InfiniiMax differential browser probe head and accessories. Includes 20 replaceable tips and ergonomic handle. Order E2658A for replacement accessories. | 1 |
| E2676A | InfiniiMax single-ended browser probe head and accessories. Includes 2 ground collar assemblies, 10 replaceable tips, a ground lead socket and ergonomic handle. Order E2663A for replacement accessories. | 1 |
| E2677A | InfiniiMax differential solder-in probe head and accessories. Includes 20 full bandwidth and 10 medium bandwidth damping resistors. Order E2670A for replacement accessories. | 1 |
| E2678A | InfiniiMax single-ended/differential socketed probe head and accessories. Includes 48 full bandwidth damping resistors, 6 damped wire accessories, 4 square pin sockets and socket heatshrink. Order E2671A for replacement accessories. | 1 |
| E2679A | InfiniiMax single-ended solder-in probe head and accessories. Includes 16 full bandwidth and 8 medium bandwidth damping resistors and 24 zero ohm ground resistors. Order E2672A for replacement accessories. | 1 |
| E2695A | Differential SMA probe head. Includes semi-rigid coax to change span between SMA connectors. | 1 |

Adapters

| Part # | Description | Quantity |
|--------|--|----------|
| N1022A | Adapts 113X/115X active probes to 86100 Infiniium DCA. | 1 |

High-Frequency Active Differential/Single-Ended Probe System

Agilent 1168A/69A InfiniiMax II High-Performance Active Probe System

InfiniiMax II: The World's Best High-Speed Probing System Just Got Better

InfiniiMax offers you the highest performance available for measuring differential and single-ended signals, with flexible connectivity solutions for today's high-density ICs and circuit boards.

InfiniiMax probes have fully characterized performance for all of their various probe heads. This includes:

- Swept frequency response plot
- Common mode rejection vs. frequency plot
- Impedance vs. frequency plot
- Time-domain probe loading plot
- Time-domain probe tracking plot

One-year standard warranty on active probes and a variety of Agilent support options to choose from.

Controlled impedance transmission lines in every probe head deliver full performance versus the performance limitations produced by traditional wire accessories.

Probe interface software allows you to save the calibration information for up to 10 different probe heads per channel and will automatically retrieve calibration data for a probe amplifier as it is attached to the scope.

High-input impedance active probes minimize loading, support differential measurements and DC offset, and can compensate for cable loss.

Probe calibration software delivers the most accurate probe measurements, linear phase response and allows various probe combinations to be deskewed to the same reference time.

InfiniiMax II probe heads



12 GHz Hi-BW solder-in differential probe head provides maximum bandwidth and minimizes capacitive loading to ≤ 210 fF. Variable spacing from 0.2 to 3.3 mm (8 to 130 mills).



12 GHz Hi-BW differential browser provides maximum bandwidth for hand-held or probe holder use. Variable spacing from 0.2 to 3.3 mm (8 to 130 mills).

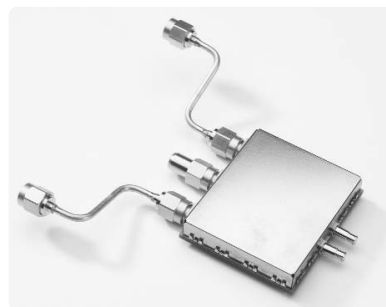

12 GHz Hi-BW differential SMA probe head provides maximum bandwidth for SMA fixtured differential pairs.



Two new high-bandwidth InfiniiMax II Series probe amplifiers have been added to the InfiniiMax product line. InfiniiMax I probe amplifiers and probe heads can also be used with InfiniiMax II Series probe amplifiers for lower performance applications.

High-Frequency Active Differential/Single-Ended Probe System

Agilent 1168A/69A InfiniiMax II High-Performance Active Probe System

Specifications

Operating Characteristics

| | | |
|--|---|---|
| Bandwidth* | 1169A: > 12 GHz (13 GHz typical) | 1168A: > 10 GHz |
| Rise and fall time <ul style="list-style-type: none"> • Probe only • When phase compensated by 80000 Series oscilloscope | Probe only, 1169A: 28 ps (20 - 80%), 40 ps (10 - 90%) 1169A with DS081204A: 25 ps (20 - 80%), 36 ps (10 - 90%) 1169A with DS081304A: 23 ps (20 - 80%), 33 ps (10 - 90%) | Probe only, 1168A: 34 ps (20 - 80%), 48 ps (10 - 90%) 1168A with DS081004A: 30 ps (20 - 80%), 42 ps (10 - 90%) |
| System bandwidth (-3 dB) | 1169A with DS081304A: 13 GHz (typical) 1169A with DS081204A: 12 GHz | 1168A with DS081004A: 10 GHz |
| Input capacitance ¹ | C _m = 0.09 pF C _m is between tips C _g = 0.26 pF C _g is to ground for each tip C _{diff} = 0.21 pF Differential mode capacitance = C _m + C _g /2 C _{se} = 0.35 pF Single-ended mode capacitance = C _m + C _g | |
| Input resistance* | Differential mode resistance = 50 kΩ ± 2% Single-ended mode resistance = 25 kΩ ± 2% | |
| Input dynamic range | 3.3 V peak to peak | |
| Input common mode range | 6.75 V peak to peak dc to 100 Hz; 1.25 V peak to peak > 100 Hz | |
| Maximum signal slew rate | 25 V/ns when probing a single-ended signal 40 V/ns when probing a differential signal | |
| DC attenuation | 3.45:1 | |
| Zero offset error referred to input | ± 1.5 mV | |
| Offset range | ± 16.0 V when probing single-ended | |
| Offset accuracy | < 3% of setting | |
| Noise referred to input | 2.5 mV rms, probe only | |
| Propagation delay | ~6 ns (this delay can be deskewed relative to other signals) | |
| Maximum input voltage | 30 V peak, CAT I | |
| ESD tolerance | > 8 kV from 100 pF, 300 Ω HBM | |

* Denotes warranted specifications, all others are typical.

¹ Measured using the probe amplifier and N5381A solder-in differential probe head.

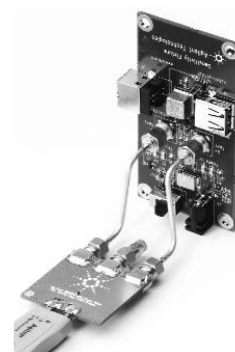
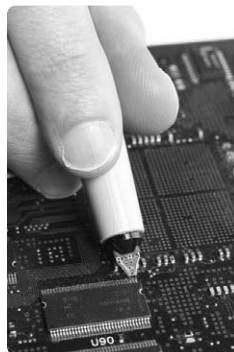

High-Frequency Active Differential/Single-Ended Probe System

Agilent 1168A/69A InfiniiMax II High-Performance Active Probe System

Ordering Information

| InfiniiMax II Probe Amplifiers | Description |
|--------------------------------|--|
| 1169A | 12 GHz InfiniiMax probe amp – order one or more probe heads. |
| 1168A | 10 GHz InfiniiMax probe amp – order one or more probe heads. |

| InfiniiMax II Probe Heads | Recommended for use with InfiniiMax II probe amplifiers |
|---------------------------|--|
| N5380A | InfiniiMax II 12 GHz differential SMA adapter. Includes semi-rigid coax to change span between SMA connectors. |
| N5381A | InfiniiMax II 12 GHz differential solder-in probe head and accessories. Includes wire for replacement leads. Order 01169-21306 for 0.005 inch or 01169-81301 for 0.007 inch replacement nickel wire. |
| N5382A | InfiniiMax II 12 GHz differential browser. Includes wire for replacement leads. Order 01169-21304 for 0.005 inch replacement steel wire. |

| InfiniiMax I probe heads* | Can be used with InfiniiMax II probe amplifiers with limitations |
|---------------------------|--|
| E2675A | InfiniiMax differential browser probe head and accessories. Includes 20 replaceable tips and ergonomic handle. Order E2658A for replacement accessories. |
| E2676A | InfiniiMax single-ended browser probe head and accessories. Includes 2 ground collar assemblies, 10 replaceable tips, a ground lead socket and ergonomic browser handle. Order E2663A for replacement accessories. |
| E2677A | InfiniiMax differential solder-in probe head and accessories. Includes 20 full bandwidth and 10 medium bandwidth damping resistors. Order E2670A for replacement accessories. |
| E2678A | InfiniiMax single-ended/differential socketed probe head and accessories. Includes 48 full bandwidth damping resistors, 6 damped wire accessories, 4 square pin sockets and socket heatshrink. Order E2671A for replacement accessories. |
| E2679A | InfiniiMax single-ended solder-in probe head and accessories. Includes 16 full bandwidth and 8 medium bandwidth damping resistors and 24 zero ohm ground resistors. Order E2672A for replacement accessories. |
| E2695A | Differential SMA probe head. Includes semi-rigid coax to change span between SMA connectors. |

* (See *Benefits* section of publication number 5989-1487EN/ENUS for specifications and limitations when used with InfiniiMax II Series probe amplifiers.)

| Adapters | Description |
|----------|--|
| N1022A | Adapts 113x/115x active probes to 86100 Infiniium DCA. |

High-Frequency Active Single-Ended Voltage Probes

Agilent 1155A Active Single-Ended Voltage

- Easy connection to fine-pitch ICs, SMDs, and dense circuit boards
- Lightweight (< 1 gram), low mass probe tip
- Two channels, 750 MHz bandwidth

Low Cost, Great Performance

Talk about big performance in a small package! The two-channel, low-mass 1155A combines a probe tip that weighs less than 1 gram with the superior performance of an active probe. It's a powerful combination, ideal for connecting to and testing fine-pitch ICs, surface mount devices, and dense circuit boards.

The 1155A probe joins high bandwidth (750 MHz), low input capacitance (2 pF), and high resistance (1 M Ω). These features are well suited for measuring fast transition times on low voltage signals that cannot tolerate the circuit loading of passive probes.

A Wedge Probe Adapter, included with the probe, allows for hands-free probing of 0.5 mm ICs. The Wedge provides accurate, mechanically non-invasive electrical contact to the IC legs with little chance of shorting. It's easy to insert and it stays put. For more information on the Wedge, see "Probing Accessories." Leads are available for connecting to a wide variety of test points. See "Ordering Information" for a complete list.

These probes are compatible with the AutoProbe interface, which completely configures the oscilloscope for use with the probe. Power for the active probe is supplied by the oscilloscope. A snap-on BNC connector simplifies attaching the probe to the scope.

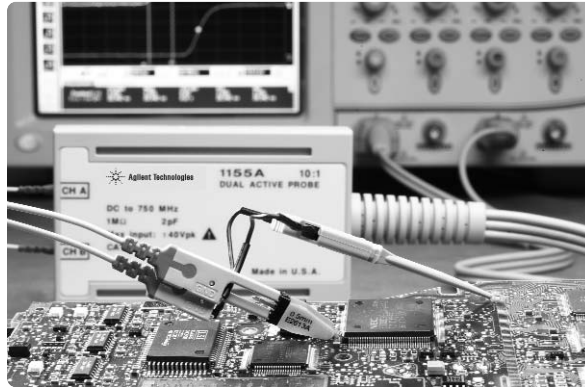

Figure 3.6. Agilent Wedge Probe Adapter for reliable, hands-free probing of 0.5 mm ICs.

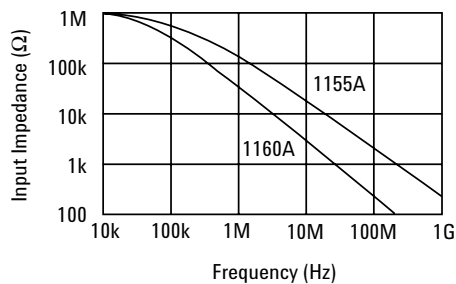

Figure 3.7. Comparison of input impedance versus frequency, showing the higher input impedance of the 1155A probe.



Figure 3.8. Agilent 1155A for fine-pitch ICs, SMDs, and dense circuit boards.

High-Frequency Active Single-Ended Voltage Probes

Agilent 1155A Active Single-Ended Voltage

Specifications

Operating Characteristics

| | |
|-----------------------|--|
| Bandwidth (–3 dB) | dc to ≥ 750 MHz |
| System bandwidth | 500 MHz with 600 MHz MSO/DSO8064A, 54830B/D, 31B/D scopes 670 MHz with 1 GHz MSO/DSO8104A, 54832B/D, 33B/D scopes |
| Rise time* | ≤ 470 ps |
| Attenuation factor* | 10:1 $\pm 3\%$ |
| dc input resistance* | 1 M Ω $\pm 2\%$ |
| Input capacitance | 2 pF (typical) |
| Flatness | Less than $\pm 10\%$ for first 6 ns, $\pm 4\%$ from 6 ns to 20 μ s, $\pm 1.5\%$ thereafter |
| Input dynamic range | 0 to 6.0 V |
| Maximum input voltage | ± 40 V (dc + peak ac), CAT I |

Environmental Characteristics

| | |
|-------------------------|--------------------------------------|
| Temperature (operating) | 0° C to +55° C |
| Humidity (operating) | Up to 95% relative humidity at 40° C |

* Denotes specified parameters. All others are characteristics.

Ordering Information

Probe and Accessories

| Part # | Description | Quantity |
|--------|---|----------|
| 1155A | Low mass, 2-channel active probe | 1 |
| | IC clips: See "Probing Accessories" | |
| | Wedge Probe Adapters: See "Probing Accessories" | |

Replacement Parts

| Part # | Description | Quantity |
|-------------|------------------------|-------------------|
| 01145-61602 | Probe tip and cable | 1 |
| 16517-82104 | SMT leads | 4 red, 4 black |
| 16517-82105 | Spacing ground adapter | 20 |
| 16517-82106 | Flexible leads | 20 |
| 16517-82107 | Pin probe kit | 4 |
| 5090-4833 | SMT clip | 20 |

Accessories Supplied

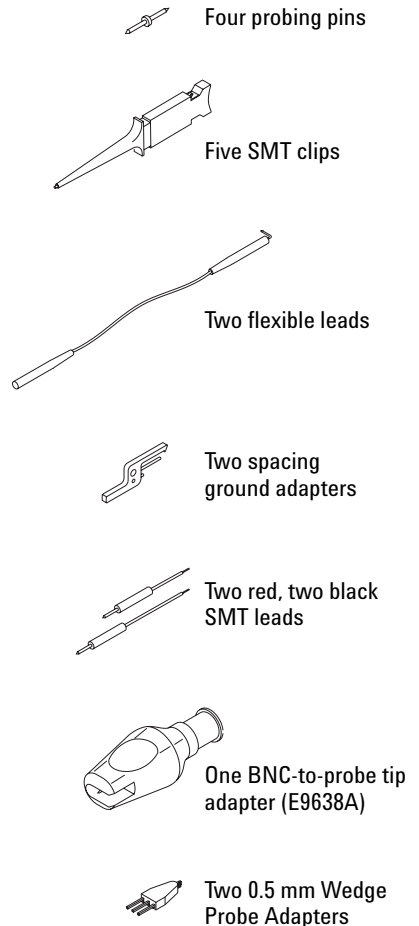

Includes user's guide and one-year warranty.

High-Frequency Active Single-Ended Voltage Probes

Agilent 1156A/57A/58A High-Bandwidth, Active Single-Ended Voltage

- Ideal for a range of hi-speed applications
- 88 ps rise time (on 4 GHz model)
- 100 k Ω , 0.8 pF, non-resonant input impedance
- 5 V peak-to-peak dynamic range
- ± 15 V offset
- Accessories designed for minimal device loading and optimal response
- Small size for easier probing

As the speeds in your design increase, you may notice more overshoot, ringing, and other perturbations when connecting an oscilloscope probe. Probes form a resonant circuit where they connect to the device. If this resonance is within the bandwidth of the oscilloscope probe you are using, it will be difficult to determine if the measured perturbations are due to your circuit or the probe.

These probes are compatible with the AutoProbe interface, which completely configures the oscilloscope for use with the probe. Power for the active probe is supplied by the oscilloscope.

Faithful Reproduction of Your Signal

Now you can accurately measure your hi-speed signals without introducing errors from a probe that has a resonant input impedance or non-flat frequency response. With the 1156A/57A/58A probes, a damping resistor is placed as close as possible to the point being probed, which keeps the input impedance from resonating low, and it also allows a flat frequency response across the entire bandwidth of the probe. Finally, there is a high-bandwidth active probe where the waveform

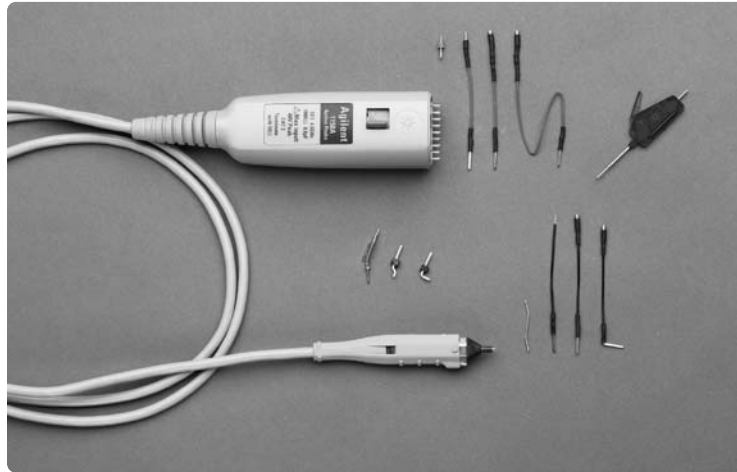

Figure 3.9. Agilent 1156A/57A/58A active probe for hi-speed signals.

onscreen matches the waveform at the probe tip. The 1158A offers a flat response for the entire bandwidth of a 4 GHz probe!

Small Size

Have you experienced problems with large, clunky probes? If so, you probably found your probe awkward to hold and had difficulty connecting to your signals. With the small size of the 1156A/57A/58A, you can handle the probe expertly and gain access to tight spaces. Plus, the low mass makes the probe more durable. Agilent makes your job easier—giving you performance that is easy to use.

Superior Accessories

Your device under test (DUT) determines the type of probing accessories you need. Of course, there are electrical trade-offs depending on the type of connection you use. Longer connections from your DUT produce lower performance probing systems.

Agilent offers a variety of accessories optimized to give you the most accurate reproduction of your signal. In addition, the performance of each accessory is characterized for you. Now you can make informed decisions and get the best measurement for your environment. Superior performance combined with the knowledge to use it—that's how Agilent helps you do your job better.

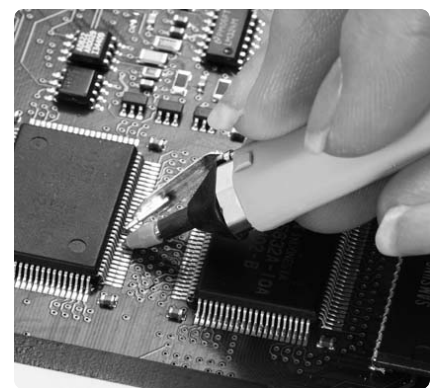

Figure 3.10. Probe with resistive signal pin and ground blade.

High-Frequency Active Single-Ended Voltage Probes

Agilent 1156A/57A/58A High-Bandwidth, Active Single-Ended Voltage

Specifications

Operating Characteristics

| | |
|--|---|
| Bandwidth (−3 dB) | 1156A: > 1.5 GHz; 1157A: > 2.5 GHz; 1158A: > 4 GHz |
| System bandwidth (−3 dB) | 1156A with MSO/DSO8104A, 54832B/D, 54833A/D scope: 1 GHz; 1157A with 54852A scope: 2 GHz; 1157A with 54853A scope: 2.5 GHz; 1158A with 54854A scope: 4 GHz |
| Rise and fall time (10% to 90%) calculated from $t_r = 0.35/\text{bandwidth}$ | 1156A: < 233 ps; 1157A: < 140 ps; 1158A: < 88 ps |
| Input capacitance | 0.8 pF |
| Input resistance [1] | 100 k Ω 1% |
| Flatness, swept response | 0.2 dB: 100 kHz to 100 MHz; 0.4 dB: 100 MHz to 2.5 GHz; 2.0 dB: 2.5 GHz to 4.0 GHz |
| Flatness, step response | 15% overshoot: 35 ps input edge; 10% overshoot: 75 ps input edge; 2%: 1 ns after edge |
| Dynamic range [2] | > 5.0 V peak-to-peak |
| dc attenuation [1] | 10:1 \pm 3% before calibration [4]; 10:1 \pm 1% after calibration [4] |
| Zero offset error referred to input [1] | < 30 mV before calibration [4]; < 5 mV after calibration [4] |
| Offset range [1] | \pm 15.0 V |
| Offset accuracy [1] | < 3% of setting before calibration [4]; 1% of setting after calibration [4] |
| Noise referred to input | 3.0 mVrms |
| Propagation delay | 5.5 ns |
| Maximum input voltage | 40 V peak, CAT I [3] |
| ESD tolerance | > 5 kV from 100 pF, 300 Ω HBM |
| Temperature drift | Offset: < 1.0 mV/°C; Attenuation (Gain): 0.1 %/°C |

[1] Denotes warranted specifications, all others are typical.

[2] For waveforms with edges > 3 ns, the dynamic range is > 12.0 V peak-to-peak.

[3] Installation category (over voltage category) I: Signal level, special equipment, or parts of equipment, telecommunication, electronic, etc., with smaller transient overvoltage than installation category (overvoltage category) II.

[4] Probe calibrated to scope channel (under Probes Setup menu).

Environmental Characteristics

| | |
|-------------|---|
| Temperature | Operating: 0° C to +55° C; Non-operating: −40° C to +70° C |
| Humidity | Operating: Up to 95% relative humidity (non-condensing) at +40° C; Non-operating: Up to 90% relative humidity at +65° C |

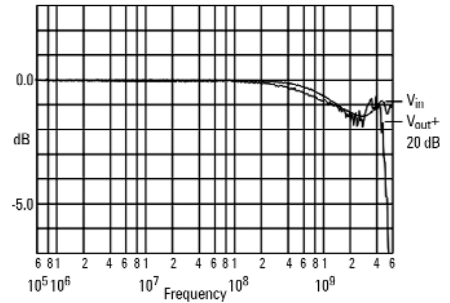

Figure 3.11. Notice how closely output matches input. Graph shows V_{in} and V_{out} when driven from a 25 Ω source.

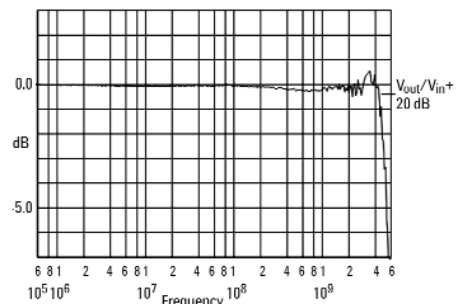

Figure 3.12. The flat response means the waveform on the scope screen will match the waveform at the probe tip—across an entire 4 GHz bandwidth. Graph shows response (V_{out}/V_{in}).

High-Frequency Active Single-Ended Voltage Probes

Agilent 1156A/57A/58A High-Bandwidth, Active Single-Ended Voltage

Ordering Information

| Part # | Description | Quantity |
|--------|-----------------------|----------|
| 1156A | 1.5 GHz active probe* | 1 |
| 1157A | 2.5 GHz active probe* | 1 |
| 1158A | 4 GHz active probe* | 1 |

* The Infiniium 54800A Series scope requires version A.04.30 or greater of the application software to work with the 1156A/7A/8A probes. An LS-120 drive is required for this upgrade.

Accessories

| Part # | Description | Quantity |
|--------|---|----------|
| E2637A | Precision measurement kit (includes 2 solderable ground sockets with 2 green resistive signal pins) | 1 |
| E2638A | Solderable-tip 5 cm resistive signal leads (10) with ground leads (3) | 1 |
| E2639A | Micro clips | 4 |
| E2640A | Resistive signal pins, (orange) | 8 |
| E2641A | Ground blade assembly | 8 |

Accessories Supplied

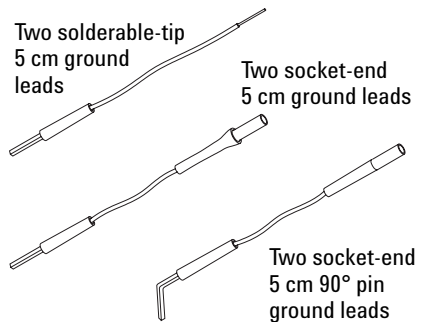
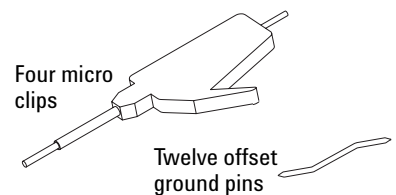
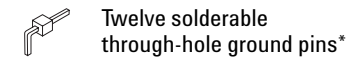
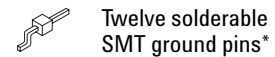
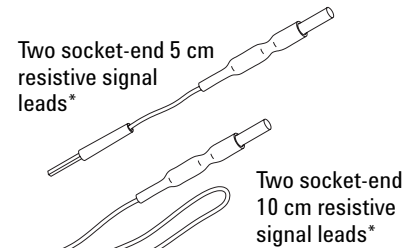
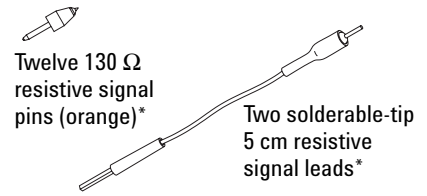

Includes user's guide and one-year warranty.

These accessories are properly damped to give you a flat transmitted response and non-resonant input impedance. Use these supplied accessories to get the best performance from your probe.

High-Frequency Passive Voltage Probe

Agilent 54006A 6 GHz Resistor Divider Probe

- **Useful in probing high-frequency signals with low source impedance**
- **Supplied with 10:1, 500 Ω and 20:1, 1 k Ω resistor dividers**
- **Low capacitive loading to extremely high frequencies**

The Agilent 54006A allows you to probe signals up to 6 GHz using replaceable tips that provide either 10:1 division ratio with 500 Ω input resistance, or a 20:1 division ratio with 1 k Ω input resistance. This 6 GHz probe gives access to circuit nodes that are not 50 Ω or do not have 50 Ω connectors allowing

you to see signals at specific points, such as the input to a gate. Agilent 54006A's input capacitive loading is approximately 0.25 pF, allowing you to get very accurate timing measurements for a wide bandwidths of signals.

The 54006A probe is a good, low-cost alternative for high frequency probing where the higher resistive loading is not an issue and the other features of the InfiniiMax probing system are not needed (such as differential inputs and multiple connectivity options).



Figure 3.14. Agilent 54006A for probing high frequency, up to 100 Ω impedance signals.

Specifications

Operating Characteristics

| | |
|-------------------------|-----------------------------|
| Bandwidth (-3 dB) | 6 GHz |
| Attenuation ratio | 10:1, 20:1 |
| Input resistance | 500 Ω , 1 k Ω |
| Input capacitance | 0.25 pF |
| Max dc volts | 20 V |
| Length in meters (feet) | 0.9 m (3 ft) |

Ordering Information

| Part # | Description | Quantity |
|---------|--|----------|
| 54006A* | 6 GHz Resistor Divider Probe Includes: One 10:1 500 Ω probe body, six 450 Ω resistors, One 20:1, 1 k Ω probe body, six 950 Ω resistors, One 36 in, 50 Ω coaxial cable, SMA (m-m) One blocking cap, 10 GHz-26 GHz APC - 3,5 (m-f) | 1 |

* Requires the 54855-67604 SMA to precision-BNC adapter to connect to BNC scope input.

Differential Voltage Probes Overview

Differential probes are active probes with two inputs, one positive and one negative, as well as a separate ground lead. They are used to look at signals that are referenced to each other instead of earth ground and to look at small signals in the presence of large dc offsets or other common mode signals such as noise. The differential amplifier in the probe rejects signals that are common

to the two inputs, removing the dc or common mode signals and leaving the signal of interest. The common mode rejection ratio (CMRR) characterizes how effectively the probe rejects signals common to each input. The CMRR for differential signals is much higher than using two passive probes and subtracting the signals with a math function.

Differential probes are used with RF communication ICs, semiconductor characterization (RAM-BUS, Double Data Rate, DRAM, AGP), battery-powered communication and computing equipment (cellular phone, laptop computer, etc.), disk drive read-write channel signals, power supply design and verification, motor speed controls, electronic high-power converters, and other applications where signals are “floating” above ground.



Figure 4.1. Agilent 1153A for probing low-bandwidth differential signals.



Figure 4.2. Agilent 1130A InfiniiMax probe amplifier and E2675 differential browser probe head, ordered separately.

| Model | Probe Type | Applications and Use | Page |
|-------------------|---------------------|---|------|
| 1153A | Active Differential | Measure low-bandwidth differential signals | 25 |
| 1130A/31A/32A/34A | Active Diff/SE | Measure both differential and single-ended signals up to 7 GHz | 12 |
| 1168A/69A | Active Diff/SE | Measure both differential and single-ended signals up to 13 GHz | 15 |

Differential Probe Advantages

View small signals in the presence of dc or other common mode signals

1153A probes both low- and high-voltage differential signals with low thermal drift

1168A/69A and 1130A/31A/32A/34A probes both single-ended and differential signals up to 13 GHz bandwidth

Limitations

More expensive than general-purpose probes
Less dynamic range than using two passive probes

200 MHz bandwidth

Lower dynamic range and lower maximum input voltage

Active Differential Voltage Probes

Agilent 1153A Low-Bandwidth Active Differential Voltage

- **View of low-bandwidth differential signals in the presence of much larger common-mode signals**
- **dc to 200 MHz bandwidth**
- **Input from ± 300 mV (dc + peak ac) to ± 30 V with attenuation**
- **3000:1 CMRR at 1 MHz**
- **Input coupling: dc offset, low-frequency reject, ac coupling**
- **Low dc thermal drift**

Reliable Probing of Low-Bandwidth Signals

The Agilent 1153A is a 1:1 FET differential probe with 200 MHz bandwidth and 3000:1 CMRR (Common Mode Rejection Ratio) at 1 MHz. Two attenuators, 10:1 and 100:1, expand the dynamic range of the inputs up to + 30 V. The probe has a high input resistance of 1 M Ω and low input capacitance of 7 pF to minimize circuit loading.

Input coupling modes include dc, dc with variable offset, and low-frequency (LF) reject. The probe also comes with an ac coupling adapter for those cases where

the input dc voltage level prevents the use of LF reject. LF reject, like ac coupling, blocks the dc component in a signal without degrading low frequency CMRR, which occurs when you use blocking capacitors to accomplish ac coupling. The probe's dual-path amplifier design provides superior dc stability by reducing the drift to less than 50 μ V dc per degree Celsius.

The 1153A is designed for reliability through use of over-voltage protection circuitry, which decreases the probe's susceptibil-

ity to damage from electrostatic discharge and other accidental exposure to excessive voltage. Special attention is paid to isolating critical parts from shock.

The probe is compatible with the AutoProbe interface, which completely configures the Infiniium scope for the probe. The probe interface recognizes the probe and automatically sets up the proper power, coupling modes, 50 Ω impedance, and offset range. A snap-on BNC connector simplifies connecting the probe to the scope.

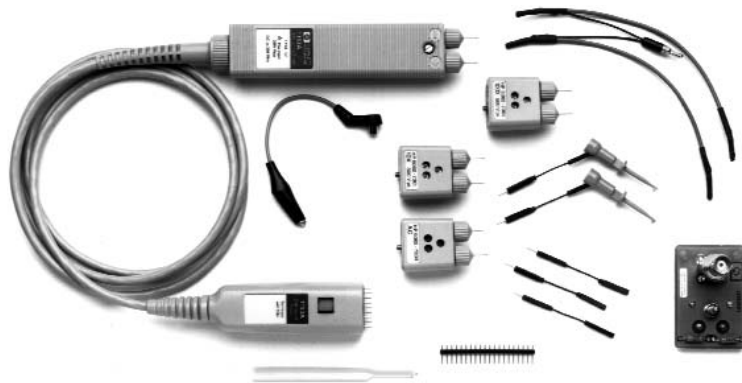

Figure 4.3. Agilent 1153A 1:1 FET differential probe with 200 MHz bandwidth.

Active Differential Voltage Probes

Agilent 1153A Low-Bandwidth Active Differential Voltage

Specifications

Operating Characteristics

| | |
|----------------------------------|---|
| Bandwidth (–3 dB) | dc to 200 MHz [1] |
| Rise time | 1.75 ns calculated from $t_r = (0.35/\text{bandwidth})$ |
| dc gain accuracy* | 2% (with $50 \pm 0.1 \Omega$ load) |
| dc attenuator accuracy | 2% |
| Linear differential input range | ± 0.3 V (1:1); ± 3.0 V (10:1); ± 30 V (100:1) |
| dc offset | ± 18 V (1:1); ± 180 V (10:1); ± 500 V (100:1) |
| Common mode operating range | dc: ± 18 V (1:1); ± 180 V (10:1); ± 500 V (100:1) dc to 30 Hz: linearly decreased to 30 Hz value 30 Hz to 200 MHz: ± 0.5 V (1:1); ± 5 V (10:1); ± 50 V (100:1) (voltages are peak voltage) |
| Maximum allowable input voltage* | 200 V (dc + peak ac) CAT I, 1:1; 500 V (dc + peak ac) CAT I, with attenuators common or differential modes |
| Input coupling | dc, LF reject, and ac. ac coupling is provided via an adapter that attaches to the probe. LF reject response (–3 dB) is selectable independent of attenuators at 1.7 Hz (LFR1) and 0.14 Hz (LFR2). |
| CMRR* | See graph on next page. |
| ac coupling | 15 Hz (1:1); 1.5 Hz (10:1). Low-Frequency Response (–3 dB) with ac coupling adapter and input 1.5 Hz (100:1) coupling set to dc. |
| dc thermal drift | $\leq 50 \mu\text{V}$ dc/°C |
| Input RC | 1:1 R: 1 M Ω C: 7 pF 10:1 R: 9 M Ω C: 3.5 pF 100:1 R: 10 M Ω C: 2.0 pF |
| Output termination impedance | 50 Ω |
| Safety | Meets IEC 1010-2-31 |

Environmental Characteristics

| | |
|-------------|--|
| Temperature | Operating: 0° C to +55° C; Non-operating: –40° C to +70° C |
| Humidity | Operating: 95% relative humidity at 40° C; Non-operating: 90% relative humidity at +65° C |
| Altitude | Operating: Up to 4,600 m (15,000 ft); Non-operating: Up to 15,300 m (50,000 ft) |

* Denotes specified parameters. All others are characteristics.

[1] For maximum signal fidelity, above 100 MHz, limit probe output into 50 Ω to ≤ 300 mV peak-to-peak.

Active Differential Voltage Probes

Agilent 1153A Low-Bandwidth Active Differential Voltage

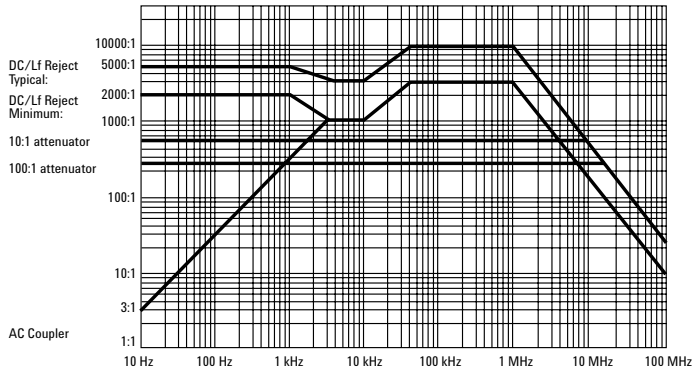

Figure 4.4. dc component in a signal blocked using low-frequency reject without degrading low-frequency CMRR.

Ordering Information

Probe and Accessories

| Part # | Description | Quantity |
|-------------------------------------|----------------------------|----------|
| 1153A | 200 MHz differential probe | 1 |
| 5959-9335 | Long (5.5 inch) test lead | 5 |
| IC clips: See "Probing Accessories" | | |

Probe Parts Supplied

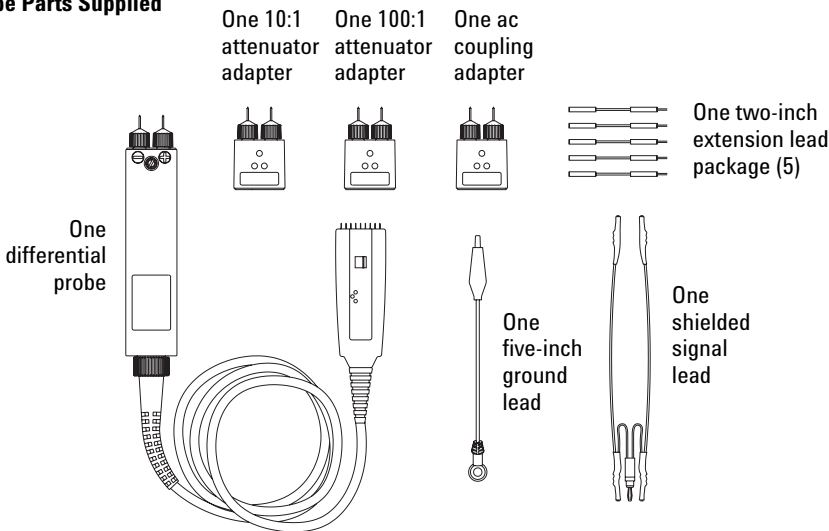

Includes one test board, flat-blade alignment tool, strip of 20 circuit connection posts, user's guide, and one-year warranty

Current Probes Overview

Current probes sense the current flowing through a conductor and convert it to a voltage that can be viewed and measured on an oscilloscope. There are two types of current probes for oscilloscopes, ac current probes (usually passive probes) and ac/dc current probes (usually active probes). Both types use the same principle of transformer action for sensing ac current in a conductor. The alternating current flowing through a conductor causes a flux field to build and collapse according to the amplitude and direction of current flow. The ac current probe head is actually a coil—when placed in this field the changing flux field induces a voltage across the coil. The ac/dc current probes also contain a Hall Effect device to sense dc and low frequency ac. Because dc doesn't cause a changing flux field it cannot be sensed by transformer action. Also, at frequencies very close to dc, the flux field may not change fast enough for measurable transformer action.



Figure 5.1. Agilent 1146A low-cost ac/dc current probe.



Figure 5.2. Agilent 1147A general-purpose ac/dc current probe.

| Model | Probe Type | Applications and Use | Page |
|-------|---------------|--|------|
| 1146A | ac/dc Current | Measure dc and ac current simultaneously. Useful for lines type power measurements. | 29 |
| 1147A | ac/dc Current | Measure dc and ac current simultaneously. Useful for pwm/switching power measurements. | 31 |

Current Probe Advantages

Limitations

1146A low-cost model measures ac and dc current to 100 Arms without breaking into the circuit

100 kHz bandwidth

1147A measures ac and dc current to 50 MHz without breaking into the circuit

15 A rated current

Current Probes

Agilent 1146A ac/dc Current

- **Low-cost solution**
- **ac/dc currents measured simultaneously**
- **Accurate measurements of currents: 100 mA to 100 Arms, dc to 100 kHz**
- **Load impedance > 1 M Ω /100 pF**

Within Budget, Without Compromise

The low-cost 1146A probe expands oscilloscope applications in industrial, automotive and power environments and is ideal for analysis and measurement of distorted current waveforms and harmonics. Accurate display and measurement of currents from 100 mA to 100 Arms, dc to 100 kHz, are made by using Hall Effect technology, eliminating the need for an electrical connection to the circuit.

Low phase shift makes this probe ideal for power quality measurements, while the high sensitivity makes it a great tool for measuring low-voltage signals. For true root mean square (RMS) measurements, the 1146A lets you meas-

ure the dc and ac output signals proportional to the total current. A battery level indicator and overload indicator help insure proper readings.

A narrow, elongated clamping mechanism lets you easily probe in crowded cable bundles and circuit boards. The probe connects directly to an oscilloscope through a 2 meter coaxial cable with an insulated BNC.

Probe power is provided by the battery, so there is no need for an external amplifier or power supply.



Figure 5.3. Agilent 1146A 100 mA to 100 Arms, dc to 100 kHz probe.

Current Probes

Agilent 1146A ac/dc Current

Specifications

Operating Characteristics

| | | |
|---|---|---------------------------|
| Current range* | 100 mV/A: 100 mA to 10 A peak; 10 mV/A: 1 to 100 A peak | |
| Output signal | 1000 mV peak max | |
| ac current accuracy* (after calibration and for one year) (zero probe before making measurement) | Range | Accuracy |
| | 100 mVA (50 mA to 10 A peak) | 3% of reading \pm 50 mA |
| | 10 mVA (500 mA to 40 A peak) | 4% of reading \pm 50 mA |
| | 10 mVA (40 A to 100 A peak) | 15% max at 100 A |
| Phase shift [1] | < 1° from dc to 65 Hz on 10 mV/A < 1.5° from dc to 65 Hz on 100 mV/A | |
| Frequency range* | dc to 100 kHz (–3 dB with current derating) | |
| Noise | Range 10 mV/A: 480 μ V; Range 100 mV/A: 3 mV | |
| Slew rate | Range 10 mV/A: 20 mV/ μ s; Range 100 mV/A: 0.3 V/ μ s | |
| Load impedance | > 1 M Ω /100 pF | |
| Insertion impedance (50/60 Hz) | 0.01 Ω | |
| Rise or fall time | Range 100 mV/A: 3 μ s; Range 10 mV/A: 4 μ s | |
| Working voltage | 600 Vrms maximum | |
| Common mode voltage | 600 Vrms maximum | |
| Influence of adjacent conductor | < 0.2 mA/A ac | |
| Influence of conductor position in jaw | 0.5% of reading at 1 kHz | |
| Battery | 9 V alkaline (NEDA 1604A, IEC 6LR61) | |
| Low battery | Green LED when \geq 6.5 V | |
| Overload indication | Red LED indicates input greater than selected range | |
| Typical consumption | 8.6 mA | |
| Battery life | 55 hours typical | |

* Characteristics marked with asterisks are specified performance. Others are typical characteristics.

[1] Reference conditions 23° C \pm 5° C, 20 to 75% relative humidity, dc to 1 kHz, probe zeroed, one minute warmup, batteries at 9 V \pm 0.1 V, external magnetic field < 40 A/m, no dc component, no external current carrying conductor, 1 M Ω /100 pF load, conductor centered in jaw.

Ordering Information

| Part # | Description | Quantity |
|--------|----------------------------------|----------|
| 1146A | ac/dc oscilloscope current probe | 1 |

Current Probes

Agilent 1147A High Bandwidth ac/dc Current

- **General purpose, high-frequency current probing**
- **ac, dc currents measured simultaneously**
- **dc to 50 MHz bandwidth**
- **15 A continuous, 50 A peak dc and ac pulse current**

Accurate Current Measurements Without Breaking the Circuit

The 1147A is a wide bandwidth, dc to 50 MHz, current probe. The probe offers flat frequency response across the entire dc to 50 MHz bandwidth, low noise (< 2.5 mArms) and low-circuit insertion loss, making it ideal for general-purpose, high-frequency current probing in lab and bench environments. This probe is the best choice for measuring steady state or transient current of motor drives, switching power supplies, inverters, controllers, disk drives, LCD displays, and current amplifiers driving inductive loads.

The probe's hybrid technology includes a Hall Effect device to sense the dc current and a current transformer to sense the ac current, making an electrical connection to the circuit unnecessary. Using split core construction, the probe easily clips on and off of a conductor up to 5 mm in diameter.

A Degauss function allows the removal of any residual magnetism that has built up in the magnetic core due to power on/off switching or excessive input. In addition, voltage offset or temperature drift on the probe can be easily corrected by using the zero adjustment dial.

The 1147A is compatible with the AutoProbe interface, which completely configures the oscilloscope for the probe. Probe power is provided by the scope, so there is no need for an external amplifier or power supply. A snap-on BNC connector simplifies connecting the probe to the scope.



Figure 5.4. Agilent 1147A 15 A rated current, 50 A peak current.

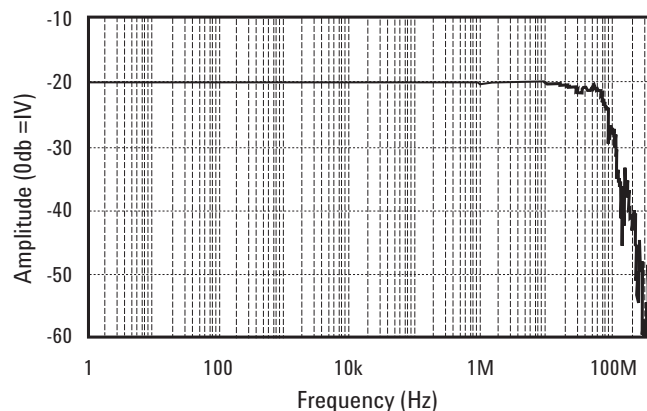

Figure 5.5. Frequency response chart showing the accuracy of the 1147A for probing wide bandwidth currents.

Current Probes

Agilent 1147A High Bandwidth ac/dc Current

Operating Characteristics

| | |
|------------------------------------|---|
| Bandwidth (-3 dB) | dc to 50 MHz |
| Rise time ¹ | 7 ns |
| Accuracy* | ±1% of reading ±1 mV |
| Maximum continuous current | 15 A (acrms + dc) Refer to derating curves above 5 kHz. |
| Maximum peak current | 50 A for pulse width ≤10 μs |
| Probe sensitivity | 0.1 V/A |
| Noise | ≤2.5 mArms with 20 MHz bandwidth limiting |
| Effect of external magnetic fields | Equivalent to ≤20 mA (for a 400 A/m magnetic field dc to 60 Hz) |
| Temperature coefficient | ±2% or less (0° C to 40° C) |
| Maximum measurable cable diameter | 5 mm (0.2 inch) |
| Sensor cable length | 1.5 m (59 inch) |

¹ Rise time is calculated as 0.35/bandwidth.

* Denotes warranted specification for the N2774A probe. All others are typical. Valid for 23° C ± 3° C (73° F ± 5° F), at least 30 minutes after power on. Requires 1 MΩ termination.

Ordering Information

| Part # | Description | Quantity |
|--------|---|----------|
| 1147A | 50 MHz current probe | 1 |
| N2774A | 50 MHz current probe. Same as 1147A, only with standard BNC scope connection. Use with 54852A/53A/54A/55A and DS080000 models along with E2697A high-impedance adapter. | 1 |
| N2775A | Probe power supply for N2774A | 1 |

High-Voltage Passive Probes Overview

High-voltage probes are used for voltages higher than can be handled safely with general-purpose 10:1 passive probes. For example, the maximum voltage for the 116XA general-purpose passive probes included with most Infiniium models is 300 volts (dc + peak ac). Agilent’s high-voltage probes have maximum ratings as high as 15,000 volts.



Figure 6.1. Agilent 10076A, 100:1, high-voltage probe.



Figure 6.2. Agilent N2771A, 1000:1, high-voltage probe.

| Model | Probe Type | Applications and Use | Page |
|--------|--------------|------------------------------|------|
| 10076A | High Voltage | Measure voltages above 300 V | 34 |
| N2771A | High Voltage | Measure voltages above 300 V | 35 |

| High-Voltage Probe Advantages | Limitations |
|--|-------------------|
| Safely measure voltages to 15 kV | Limited bandwidth |
| 10076A features a small size, low cost | Measure to 4 kV |
| N2771A provides measurements to 15 kV | Large size |

High-Voltage Passive Probes

Agilent 10076A (100:1)

- Measure voltages up to 4 kV peak
- 250 MHz bandwidth

The 10076A provides the features you need to capture fast, high-voltage signals. Its compact design makes it easy to probe today's small, power electronics components. Rugged construction enables it to withstand rough handling without breaking.



Figure 6.3. Compact design and long cable of the Agilent 10076A for probing small, power electronics components.

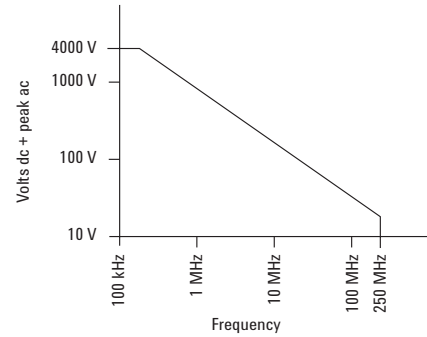

Figure 6.4. Derating curve showing bandwidth characteristics of the 10076A probe.

Specifications

Operating Characteristics

| | |
|------------------------|--|
| Bandwidth (-3 dB) | 250 MHz |
| Rise time (Calculated) | < 1.4 ns |
| Attenuation ratio | 100:1 |
| Input resistance | 66.7 M Ω (when terminated into 1 M Ω) |
| Input capacitance | Approximately 3 pF |
| Maximum input | 4000 Vpk |
| Compensation range | 6 - 20 pF |
| Probe readout | Yes |
| Cable length | 1.8 m |

Ordering Information

Probe and Accessories

| Part # | Description | Quantity |
|--------|--|----------|
| 10076A | High-voltage probe includes one retractable hook tip, one ground bayonet, one IC probing tip, one alligator ground lead, and a compensation screwdriver. | 1 |

High-Voltage Passive Probes

Agilent N2771A (1000:1)

- **Measure voltages up to 30 kV dc + peak ac, 10 kVrms**
- **50 MHz bandwidth**
- **Superior protection and safety**

For safe and accurate insight into very high-voltage designs check out our model N2771A probe. Typical applications include PMTs, motor drives, high-voltage

switches, magnetrons, and modern projection systems. The probe's large size and rugged construction provide superior protection. The ground lead feeds through the body of the probe and protrudes behind the safety barrier, keeping the ground connection away from the high voltage.



Figure 6.5. Agilent N2771A for measuring voltages up to 30 kV dc + peak ac, 10 kVrms.

Specifications

Operating Characteristics

| | |
|------------------------|--|
| Bandwidth (-3 dB) | 50 MHz |
| Rise time (calculated) | < 7 ns |
| Attenuation ratio | 1000:1 |
| Input resistance | 100 MΩ (when terminated into 1 MΩ) |
| Input capacitance | 1 pF |
| Compensation range | 7 - 25 pF |
| Maximum voltage | 15 kV dc, 10 kVrms ac, 30 kV dc + peak ac |
| Dimensions | 2 cm (maximum width of probe stem after handle) x 33 cm; 7.5 cm (maximum probe width at probe handle) x 33 cm |

Ordering Information

Probe and Accessories

| Part # | Description | Quantity |
|--------|---|----------|
| N2771A | High-voltage probe includes one alligator ground lead, one sharp probe tip, and one hook probe tip. | 1 |

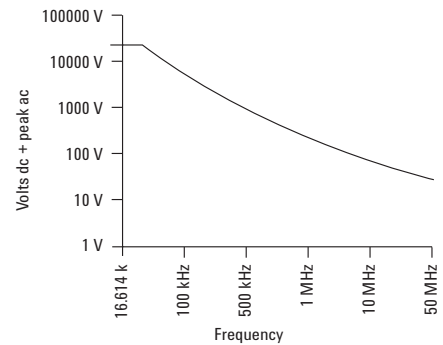

Figure 6.6. Derating curve showing bandwidth characteristics of the N2771A probe.

Mixed-Signal Oscilloscope Logic Probe Kit

- Same cable used for high-performance Agilent logic analyzers
- Flying leads offer flexibility and convenience
- IC clips with twin hooks are designed for fine surface mounted components

MSO probes offer great value and performance

The mixed-signal oscilloscope (MSO) logic probe kit for the Agilent MSO8064A, MSO8104A, and 54830D/31D/32D/33D mixed-signal oscilloscopes (MSO) makes it possible to connect at several different places on your device under test. The entire probe lead set can be grounded through the common ground. This requires

only one connection but may cause poor signal fidelity in systems with fast transition times. The recommended method is to individually ground each logic probe lead. This yields optimal signal fidelity and is

required for signals with fast transition times (<4-5 ns). This probe kit is included with the MSO8104A, MSO8064A, 54830D, 54831D, 54832D, and 54833D Infiniium mixed-signal oscilloscopes.

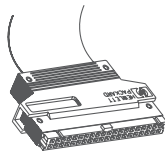

External digital cable
(part number 54826-61605)



SMT IC clip
(part number 5090-4833)

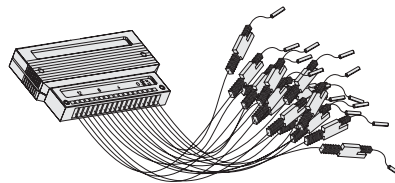

Sixteen-channel probe lead set
(part number 54838-61608)

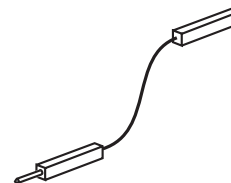

Ground leads contain 5 short ground leads
(part number 5959-9334)

Ordering Information

| Part # | Description | Quantity |
|-------------|--------------------------------------|----------|
| 54826-68701 | Logic Probe Kit for 54830 Series MSO | 1 |

Kit parts supplied

16-channel probe lead set x1
 Ground leads x5
 SMT IC clips x20
 External digital cable x1

Agilent E5396A Half-Size Soft Touch Connectorless Logic Probe

- **17 channels, single-ended clock and data**
- **< 0.7 pF equivalent load capacitance**
- **Capable of data rates > 2.5 Gb/s (maximum rate depends on analyzer used)**
- **500 mV p-p minimum signal amplitude**

The E5396A half-size soft touch connectorless probe provides convenient, reliable probing for your target system without the need for a connector. The probe has the industry's smallest footprint for use in designs that are tight on space. Because this probe uses Agilent's soft touch connectorless technology, there is no need for special plating or preparation of the probe site. This robust and reliable technology offers a long life of trouble-free probing. This probe can be used with any Agilent logic analyzer with a 40-pin cable connector or mixed-signal oscilloscope (MSO), including models MSO8064A, MSO8104A, 54830D, 54831D, 54832D, and 54833D.

Agilent MSOs are compatible with any logic analyzer probe with a 40-pin cable connector, besides the E5396A. Therefore, you can choose from the variety of 40-pin logic probing solutions available to meet your design needs. See the *Probing Solutions for Logic Analyzers* catalog, publication number 5968-4632E for more information.



Figure 8.1. E5396A.

Ordering Information

| Part # | Description | Quantity |
|--------|--|----------|
| E5396A | Half-size soft touch connectorless probe | 1 |

Probing Accessories

Wedge Adapters

Agilent Wedge Probe Adapters

- **Secure connection to 0.5 mm and 0.65 mm TQFP and PQFP devices**
- **Won't fall off, short against adjacent legs, or degrade signal quality**
- **Can be inserted while the board is active**
- **3, 8, and 16 signal versions**

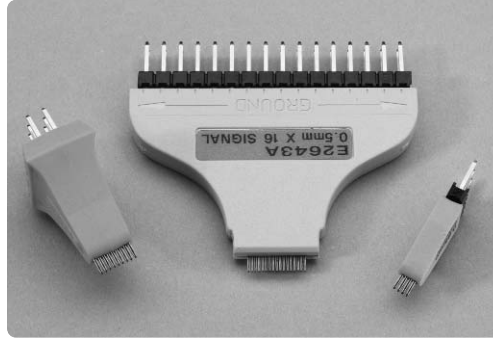

Figure 9.1. Agilent Wedge Probe Adapters for secure connections to TQFP and PQFP devices.

The Agilent Wedge Probe Adapter provides a highly reliable, mechanically non-invasive connection to fine-pitch TQFP and PQFP surface mount ICs. Compressible dual conductors inserted in the space between adjacent IC pins conform to the size and shape of each pin to ensure tight contact. The redundant physical connection created by two contact points on each pin of the IC and the short electrical length of the probe adapter dramatically increase the reliability of the electrical connection. Because the Wedge does not latch directly onto the IC and does not require expansion beforehand (unlike a clip) it can be inserted while the board is active.

Once the Wedge is inserted you can easily complete the connection to your scope. The Wedge connects directly to the Infiniium MSO logic probe flying leads, 116XA passive probe with dual lead adapter, and 1007XC passive probe with optional 10072A or 10075A that contain the dual lead adapter.

Specifications

Operating Characteristics

| | |
|------------------------------|--|
| Operating voltage | < 40 V (dc + peak ac) |
| Operating current | 0.5 A maximum |
| Capacitance between contacts | 2 pF (typical); 4.3 pF at 1 MHz (Agilent E2643A/44A) |
| Self-inductance | 15 nH (typical); 37 nH at 1 MHz (Agilent E2643A/44A) |
| Contact resistance | < 0.1 Ω |

Ordering Information

| Part # | Description | Quantity |
|--------|------------------------------------|----------|
| E2613A | IC pin spacing: 0.5 mm, 3 signal | 1 |
| E2613B | IC pin spacing: 0.5 mm, 3 signal | 2 |
| E2614A | IC pin spacing: 0.5 mm, 8 signal | 1 |
| E2615A | IC pin spacing: 0.65 mm, 3 signal | 1 |
| E2615B | IC pin spacing: 0.65 mm, 3 signal | 2 |
| E2616A | IC pin spacing: 0.65 mm, 8 signal | 1 |
| E2643A | IC pin spacing: 0.5 mm, 16 signal | 1 |
| E2644A | IC pin spacing: 0.65 mm, 16 signal | 1 |

Probing Accessories

0.5 mm IC Clips, PC Board Mini-Probe Sockets

0.5 mm IC Clips

- **Extremely small size**
- **Thin body for mounting multiple clips side-by-side**
- **Connection to PQFP and SOIC SMT packages from 0.5 to 0.8 mm (0.020 in. to 0.032 in.) lead pitch**

adapter, and 1007XC passive probe with optional 10072A or 10075A that contain the dual lead adapter. Maximum input voltage is +40 V.

The 0.5 mm IC clips connect directly to the Infiniium MSO logic probe flying leads, 116XA passive probe with dual lead



Figure 9.2. Extremely small-sized clips for probing PQFP and SOIC SMT packages.

Specifications

Operating Characteristics

| | |
|--------------|----------------------|
| Length | 31.75 mm (1.25 inch) |
| Tip diameter | 0.75 mm (0.029 inch) |
| Pin diameter | 0.75 mm (0.029 inch) |

Ordering Information

| Part # | Description | Quantity |
|-------------|-----------------|----------|
| 10467-68701 | 0.5 mm IC clips | 4 |

PC Board Mini-Probe Sockets

- **Hands-free probing of through-hole devices**
- **Compatible with 116XA family probes**

The PC board mini-probe sockets are ideal for a reliable, convenient, high bandwidth connection between the 116XA family probe tip and the circuit under test.

Ordering Information

| Part # | Description | Quantity |
|--------|------------------------------|----------|
| N2766A | Horizontal mini-probe socket | 25 |
| N2768A | Vertical mini-probe socket | 25 |

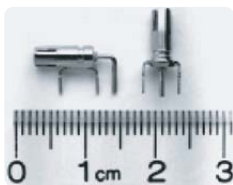

Figure 9.3. Horizontal and vertical versions of the PC board mini-probe socket make it easy to fit into your target board.

Probing Accessories

EZ-Probe Positioner[®]

EZ-Probe Positioner

- **Stable X, Y, Z positioning**
- **3-D joystick, 3:1 motion reduction**
- **Compatible with all Agilent hand-held probes**

The revolutionary EZ-Probe Positioner provides stable, accurate X, Y, and Z positioning in one fluid motion. Its unique 3-D joystick, with 3:1 motion reduction and single-clutch, fully articulated arm, allow simple, precise positioning in anything from card cages to MCMs. And, since you can easily attach any of your current handheld probes, it instantly integrates into your current probing environment.

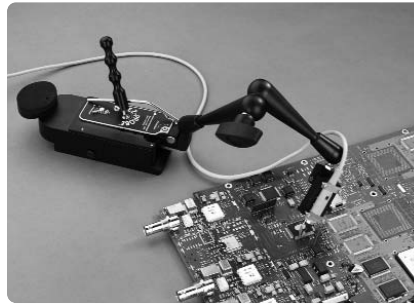

Figure 9.4. A fully articulated arm allows positioning in a variety of applications.

Specifications

Operating Characteristics

| | |
|-----------------------|--|
| Vacuum base area | 82.3 x 53.3 mm (3.2 x 2.1 inch) |
| Weight | 1.2 kg (2.65 lb.) |
| Joystick X-Y-Z travel | 17 x 17 x 13 mm (0.65 x 0.65 x 0.5 inch) |
| Arm adjustment reach | 100 - 220 mm (3.9 - 8.7 inch) |
| Arm adjustment height | 0 - 300 mm (0 - 11.8 inch) |
| Arm sweep angle | +90° |
| Probe rotation range | Infinite |

Note: The EZ-Probe Position's vacuum base requires up to -15.75 inch Hg vacuum for proper operation. Cascade Microtech offers vacuum pumps as well as many other EZ-Probe accessories.

Ordering Information

Contact Cascade Microtech at www.cascademicrotech.com to order

Logic Analyzer/Oscilloscope Time Correlation

- **Cross-trigger and time-correlate oscilloscope and logic analyzer measurements**
- **Simultaneously display oscilloscope and logic analyzer waveforms**
- **No correlation fixture required, optional for most precise correlation**

Some of the toughest measurement test problems involve linking the analog measurements of an oscilloscope and the digital measurements of a logic analyzer. But it's too time consuming to trigger your oscilloscope from your logic analyzer and try to manually correlate events.

The Agilent E5850A can bridge both worlds. The Infiniium Series oscilloscopes' tracking markers are synchronized with the global markers of an Agilent 16900 Series logic analysis system or 1680/90 benchtop logic analyzer to help you track down and isolate hard-to-find problems. With the time-correlation feature, you can trigger the Infiniium oscilloscope from an Agilent logic analyzer (or vice versa), automatically deskew the waveforms, and simultaneously view the Infiniium waveforms and the logic analyzer's timing waveforms on the analyzer screen.

With version 3.30 of logic analyzer the E5850A time correlation fixture is optional. Fast, easy setup is accomplished with just two BNC cables and the logic analyzer and oscilloscope connected to a LAN. The optional E5850A fixture can be used for most precise deskew between oscilloscope and logic analyzer signals.

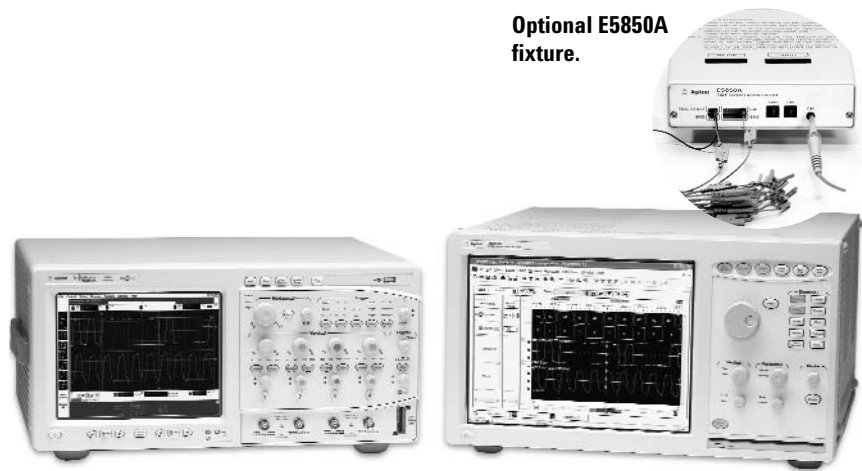

Figure 10.1. Agilent time-correlation brings the best oscilloscope and logic analyzer together for correlated debug.

Ordering Information

| Part # | Description | Quantity |
|--------|--------------------------|----------|
| E5850A | Time-correlation fixture | 1 |

VoiceControl

- **Hands-free scope operation**
- **Speaker and gender independent**
- **Uses simple English commands**

If you're making multi-channel measurements on target systems with densely packed ICs, your hands are tied up holding probes, making it difficult to turn knobs and press buttons on the front panel of your oscilloscope.

To solve this problem, Infiniium scopes can be controlled with VoiceControl. Using a collar-mounted microphone, which is included, you can control front panel functions with the use of voice controls (English only), allowing hands-free operation of the scope. VoiceControl is both speaker and gender independent and does not require the oscilloscope to be trained.

VoiceControl Functions

- Run, stop, print, autoscale, default setup, clear screen.
- Vertical controls: volts/division, offset, coupling, input impedance, channel on/off.
- Horizontal controls: time/division, delay, delayed sweep.
- Trigger controls: mode, source, slope, sweep, coupling, trigger level.
- Storage controls: save waveforms and screen images.
- Waveform measurements.
- "Undo" and "again" commands to retract or repeat last command.
- Help for VoiceControl.

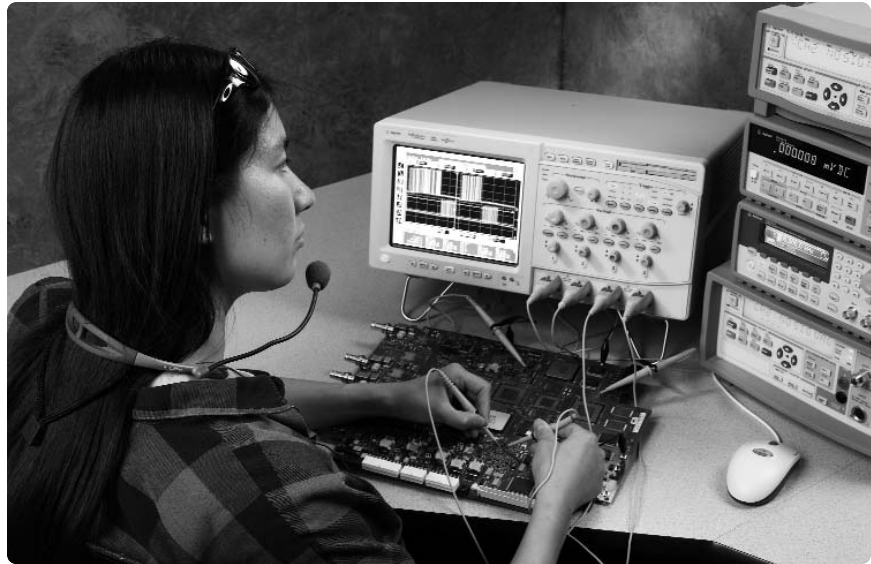

Figure 11.1. VoiceControl allows you to control the scope hands free.

Ordering Information

| Part # | Description | Quantity |
|--------|--|----------|
| N2850A | VoiceControl option for Infiniium 54830A/B/D Series with software rev. A.02.xx or below | 1 |
| E2682A | VoiceControl option for Infiniium 8000 Series with software rev A.04.90 or higher and Infiniium 54830A/B/D Series and 54850A Series with software rev. A.03.10 or higher | 1 |

Input Devices and Storage Devices

1150-7809 Keyboard, E2609B Rackmount Kit, 1184A Testmobile

1150-7809 Keyboard

The 1150-7809 mini-keyboard, included with Agilent Infiniium oscilloscopes, occupies less space on your bench or test cart and fits neatly into the Infiniium accessory pouch.



Figure 12.1. The small-sized keyboard occupies minimal space on your bench.

Ordering Information

| Part # | Description | Quantity |
|-----------|-------------|----------|
| 1150-7809 | Keyboard | 1 |

E2609B Rackmount Kit

The rackmount kit provides a support shelf and hardware for mounting Infiniium into EIA standard, 19 inch (487 mm) rack cabinets. When installed, the instrument occupies five vertical increments, 8.75 inches 222 mm each.

Ordering Information

Kit and Accessories

| Part # | Description | Quantity |
|--------|--|----------|
| E2609B | Rackmount kit (includes a support shelf, 2 rackmount rails, 1 Touchpad (E2612A), 2 brackets, and hardware) | 1 |

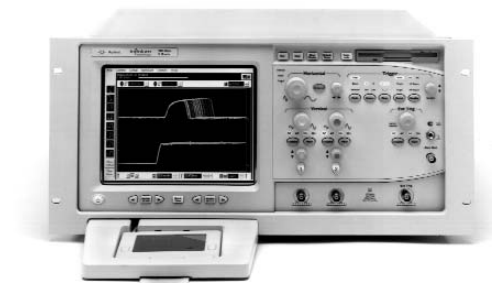

Figure 12.2. Infiniium scope ready to fit into EIA standard 19-inch cabinets.

1184A Testmobile

The Agilent 1184A testmobile gives you a convenient means of organizing and transporting your Infiniium oscilloscope and accessories. The testmobile includes a drawer for accessories (probes, cables, power cords, etc.) and a keyboard tray with adjustable tilt and height. For more information, refer to the “Agilent Test and Measurement Catalog” listed under “Related Literature” at the end of this document.

Ordering Information

| Part # | Description | Quantity |
|--------|-------------|----------|
| 1184A | Testmobile | 1 |



Figure 12.3. Agilent 1184A testmobile.

Infiniium Advanced Analysis Options

Expand the capability of your Infiniium oscilloscope with a wide variety of advanced analysis options. For more information about how these advanced analy-

sis options can speed the validation and debug of your digital design, reference the corresponding Data Sheet publication number in the list below.

| Product | Description | Application | Data Sheet |
|---------|---|------------------------|-------------|
| N5397A | FPGA Dynamic Probe for Infiniium MSOs | FPGA Debug | 5989-1848EN |
| N5400A | EZJIT Plus Jitter Analysis Software | Jitter Analysis | 5989-0109EN |
| E2681A | EZJIT Jitter Analysis Software | Jitter Analysis | 5989-0109EN |
| E2690B | Oscilloscope tools Software with Advanced Jitter Analysis | Jitter Analysis | 5989-3525EN |
| E2688A | High-speed Serial Data Analysis Software with Clock Recovery for >1 GHz Infiniium | Serial Data Analysis | 5989-0108EN |
| N5384A | High-speed Serial Data Analysis Software with Clock Recovery for ≤1 GHz Infiniium | Serial Data Analysis | 5989-0108EN |
| N5391A | Low Speed Serial Data Analysis Software for I ² C and SPI | Serial Data Analysis | 5989-1250EN |
| N5402A | CAN Serial Data Analysis Software | Serial Data Analysis | 5989-3632EN |
| 89601A | Infiniium Oscilloscopes and 89601A Vector Signal Analysis Software | Vector Signal Analysis | 5989-0947EN |
| N5393A | PCI Express Electrical Performance Validation and Compliance Software | Compliance Testing | 5989-1240EN |
| N5392A | Ethernet Electrical Performance Validation and Compliance Software | Compliance Testing | 5989-1527EN |
| N5394A | DVI Electrical Performance Validation and Compliance Software | Compliance Testing | 5989-1526EN |
| N5399A | HDMI Electrical Performance Validation and Compliance Software | Compliance Testing | 5989-3047EN |
| N5413A | DDR2 Clock Characterization Tool | Compliance Testing | 5989-3195EN |
| N5416A | USB 2.0 Electrical Performance Validation and Compliance Software | Compliance Testing | 5989-4044EN |
| E2625A | Communications Mask Test Kit | Compliance Testing | 5989-0372EN |
| E2699A | My Infiniium Integration Software | Customization Utility | 5988-9934EN |

Related Literature

| Publication Title | Publication Type | Publication Number |
|--|------------------|--------------------|
| <i>Agilent Technologies Digital and Mixed Signal Oscilloscopes</i> | Selection Guide | 5988-8460EN/ENUS |
| <i>Infiniium 8000 Series Oscilloscopes</i> | Data Sheet | 5989-4271EN/ENUS |
| <i>Infiniium 54850 Series Oscilloscopes and InfiniMax 1130 Series Probes</i> | Data Sheet | 5988-7976EN/ENUS |
| <i>Infiniium 80000 Series Oscilloscopes and InfiniMax II Series Probes</i> | Data Sheet | 5989-1487EN/ENUS |
| <i>Agilent Mixed Signal Oscilloscopes: 6-minute Video Demonstration</i> | Video CD | 5988-9288EN |

Windows® and MSWindows® are U.S. registered trademarks of Microsoft Corporation.
EZ-Probe Positioner® is a U.S. registered trademark of Cascade Microtech Inc.

Agilent Technologies' Test and Measurement Support, Services, and Assistance

Agilent Technologies aims to maximize the value you receive, while minimizing your risk and problems. We strive to ensure that you get the test and measurement capabilities you paid for and obtain the support you need. Our extensive support resources and services can help you choose the right Agilent products for your applications and apply them successfully. Every instrument and system we sell has a global warranty. Two concepts underlie Agilent's overall support policy: "Our Promise" and "Your Advantage."

Our Promise

Our Promise means your Agilent test and measurement equipment will meet its advertised performance and functionality. When you are choosing new equipment, we will help you with product information, including realistic performance specifications and practical recommendations from experienced test engineers. When you receive your new Agilent equipment, we can help verify that it works properly and help with initial product operation.

Your Advantage

Your Advantage means that Agilent offers a wide range of additional expert test and measurement services, which you can purchase according to your unique technical and business needs. Solve problems efficiently and gain a competitive edge by contracting with us for calibration, extra-cost upgrades, out-of-warranty repairs, and on-site education and training, as well as design, system integration, project management, and other professional engineering services. Experienced Agilent engineers and technicians worldwide can help you maximize your productivity, optimize the return on investment of your Agilent instruments and systems, and obtain dependable measurement accuracy for the life of those products.

Agilent Open

www.agilent.com/find/open

Agilent Open simplifies the process of connecting and programming test systems to help engineers design, validate and manufacture electronic products. Agilent offers open connectivity for a broad range of system-ready instruments, open industry software, PC-standard I/O and global support, which are combined to more easily integrate test system development.

Agilent Email Updates

www.agilent.com/find/emailupdates

Get the latest information on the products and applications you select.

Agilent Direct

www.agilent.com/find/agilentdirect

Quickly choose and use your test equipment solutions with confidence.

For more information on Agilent Technologies' products, applications or services, please contact your local Agilent office. The complete list is available at:

www.agilent.com/find/contactus

Phone or Fax

United States:

(tel) 800 829 4444
(fax) 800 829 4433

Canada:

(tel) 877 894 4414
(fax) 800 746 4866

China:

(tel) 800 810 0189
(fax) 800 820 2816

Europe:

(tel) 31 20 547 2111

Japan:

(tel) (81) 426 56 7832
(fax) (81) 426 56 7840

Korea:

(tel) (080) 769 0800
(fax) (080) 769 0900

Latin America:

(tel) (305) 269 7500

Taiwan:

(tel) 0800 047 866
(fax) 0800 286 331

Other Asia Pacific Countries:

(tel) (65) 6375 8100
(fax) (65) 6755 0042

Email: tm_ap@agilent.com

Contacts revised: 05/27/05

Product specifications and descriptions in this document subject to change without notice.

© Agilent Technologies, Inc. 2005

Printed in USA, December 1, 2005

5968-7141EN