

MADE IN  
**USA**



# User's Guide

Shop online at

**omega.com**<sup>®</sup>

Ω OMEGA<sup>®</sup>

*omega.com*

*e-mail: info@omega.com*

*For latest product manuals:  
omegamanual.info*

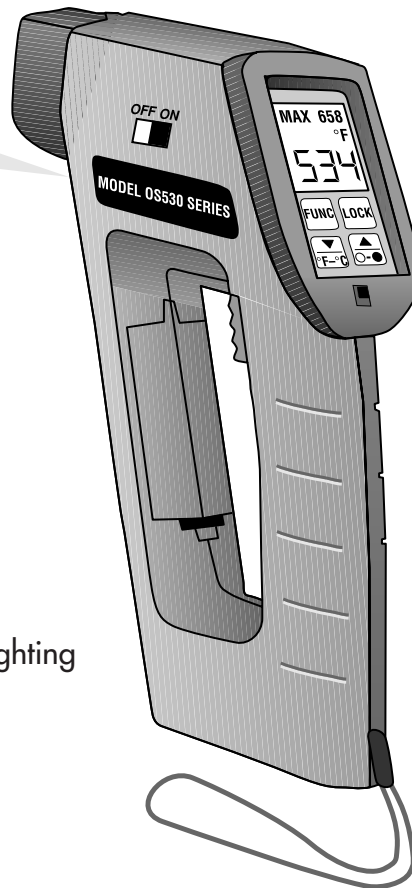
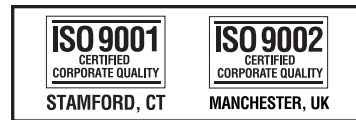

Shown with  
Built-in Laser Sighting

**OS531, OS532, OS53x-CF,  
OS533, OS534, OS530L, OS530HR  
OS523, OS524 OMEGASCOPE<sup>®</sup>  
Handheld Infrared Thermometer**



OMEGAnet® Online Service  
omega.com

Internet e-mail  
info@omega.com

### Servicing North America:

**U.S.A.:**  
ISO 9001 Certified

One Omega Drive, Box 4047  
Stamford, CT 06907-0047  
Tel: (203) 359-1660 FAX: (203) 359-7700  
e-mail: info@omega.com

**Canada:**

976 Bergar  
Laval (Quebec) H7L 5A1, Canada  
Tel: (514) 856-6928 FAX: (514) 856-6886  
e-mail: info@omega.ca

### For immediate technical or application assistance:

**U.S.A. and Canada:** Sales Service: 1-800-826-6342 / 1-800-TC-OMEGA®  
Customer Service: 1-800-622-2378 / 1-800-622-BEST®  
Engineering Service: 1-800-872-9436 / 1-800-USA-WHEN®

**Mexico:**

En Español: (001) 203-359-7803 e-mail: espanol@omega.com  
FAX: (001) 203-359-7807 info@omega.com.mx

### Servicing Europe:

**Benelux:**

Postbus 8034, 1180 LA Amstelveen, The Netherlands  
Tel: +31 (0)20 3472121 FAX: +31 (0)20 6434643  
Toll Free in Benelux: 0800 0993344  
e-mail: sales@omegaeng.nl

**Czech Republic:**

Frystatska 184, 733 01 Karviná, Czech Republic  
Tel: +420 (0)59 6311899 FAX: +420 (0)59 6311114  
Toll Free: 0800-1-66342 e-mail: info@omegashop.cz

**France:**

11, rue Jacques Cartier, 78280 Guyancourt, France  
Tel: +33 (0)1 61 37 2900 FAX: +33 (0)1 30 57 5427  
Toll Free in France: 0800 466 342  
e-mail: sales@omega.fr

**Germany/Austria:**

Daimlerstrasse 26, D-75392 Deckenpfronn, Germany  
Tel: +49 (0)7056 9398-0 FAX: +49 (0)7056 9398-29  
Toll Free in Germany: 0800 639 7678  
e-mail: info@omega.de

**United Kingdom:**

ISO 9002 Certified

One Omega Drive, River Bend Technology Centre  
Northbank, Irlam, Manchester  
M44 5BD United Kingdom  
Tel: +44 (0)161 777 6611 FAX: +44 (0)161 777 6622  
Toll Free in United Kingdom: 0800-488-488  
e-mail: sales@omega.co.uk

It is the policy of OMEGA Engineering, Inc. to comply with all worldwide safety and EMC/EMI regulations that apply. OMEGA is constantly pursuing certification of its products to the European New Approach Directives. OMEGA will add the CE mark to every appropriate device upon certification.

The information contained in this document is believed to be correct, but OMEGA accepts no liability for any errors it contains, and reserves the right to alter specifications without notice.

**WARNING:** These products are not designed for use in, and should not be used for, human applications.





Remove the Packing List and verify that you have received all equipment, including the following (quantities in parentheses):

- OS530/OS520 Series Handheld Infrared Thermometer (1)
- AA Size Lithium Batteries (4)
- Soft Cover Carrying Case (1)
- Analog Cable (1)
- RS232 Cable (only for OS533, OS534, OS523, OS524)
- CD Software (only for OS533, OS534, OS523, OS524)
- Quick Start Manual (1)
- User's Guide (1)

### Accessories

Model No.	Description
OS520-ADAPTER-110V	110 VAC wall Adaptor, 9 VDC @ 200 mA
OS520-ADAPTER-220V	230 VAC wall Adaptor, 9 VDC @ 300 mA
OS520-RCC	Hard Carrying Case, Standard
OS520-SC-RCC	Hard Carrying Case, Large
88013K	Surface Probe, K Type T/C, up to 815°C (1500°F)
88001K	Surface Probe, K Type T/C, up to 482°C (900°F)
CAL-3-IR	NIST Traceable Calibration
SC-520	Sighting Scope

If you have any questions about the shipment, please call the Customer Service Department at:

**1-800-622-2378 or 203-359-1660.** We can also be reached on the Internet at

**[www.omega.com](http://www.omega.com)**

**e-mail: [info@omega.com](mailto:info@omega.com)**

When you receive the shipment, inspect the container and equipment for signs of damage. Note any evidence of rough handling in transit. Immediately report any damage to the shipping agent.

#### NOTE

The carrier will not honor damage claims unless all shipping material is saved for inspection. After examining and removing contents, save packing material and carton in the event reshipment is necessary.



	<b>Page</b>
<b>Unpacking Instructions</b>	<b>i</b>
<b>Chapter 1 General Description</b> .....	<b>1-1</b>
1.1 Introduction	1-1
1.2 Parts of the Thermometer	1-4
1.2.1 Front of the Thermometer	1-4
1.2.2 Rear of the Thermometer	1-6
<b>Chapter 2 Using the Handheld Infrared Thermometer</b> .....	<b>2-1</b>
2.1 How to Power the Thermometer	2-1
2.1.1 Battery Operation	2-1
2.1.2 ac Power Operation	2-1
2.2 Operating the Thermometer	2-2
2.2.1 Measurement Techniques	2-6
2.3 Real Time Mode (Active Operation)	2-8
2.3.1 Adjusting Emissivity	2-11
2.3.2 Using the LOCK Function	2-11
2.3.3 Calculating Temperature Values	2-12
2.3.4 Changing the Temperature from °F to °C (or vice versa)	2-12
2.3.5 Turning on the Display Backlighting	2-12
2.3.6 Thermocouple Input	2-13
2.3.7 Using the Alarm Functions	2-14
2.3.8 Using Ambient Target Temperature Compensation	2-16
2.3.9 Sending Temperature Data to a Series Printer	2-17
2.3.10 Sending Temperature Data to a Personal Computer	2-19
2.3.10.1 Software Installation	2-19
2.3.11 Storing the Temperature Data on Command	2-23
2.3.12 Erasing the Temperature Data form Memory	2-24
2.4 Recall Mode (Passive Operation)	2-25
2.4.1 Reviewing the Last Parameters	2-27
2.4.2 Downloading PReviously Stored Temperature Data	2-27
2.4.3 Reviewing Previously Stored Temperature	2-29
<b>Chapter 3 Laser Sighting</b> .....	<b>3-1</b>
3.1 Warnings and Cautions	3-1
3.2 Description	3-2
3.3 Operating the Laser Sighting	3-3
<b>Chapter 4 Sighting Scope</b> .....	<b>4-1</b>
<b>Chapter 5 Maintenance</b> .....	<b>5-1</b>
5.1 Replacing the Batteries	5-1
5.2 Cleaning the Lens	5-2
5.3 Calibrating the Thermometer	5-2
5.4 Servicing the Laser Sighting	5-2
<b>Chapter 6 Troubleshooting Guide</b> .....	<b>6-1</b>
<b>Chapter 7 Specifications</b> .....	<b>7-1</b>
<b>Chapter 8 Glossary of Key Strokes</b> .....	<b>8-1</b>



---

**Appendix A How Infrared Thermometry Works ..... A-1**  
**Appendix B Emissivity Values ..... B-1**  
**Appendix C Determining an Unknown Emissivity ..... C-1**  
**Index ..... I-1**

## 1.1 Introduction

The OS530/OS520 series Handheld Infrared (IR) Thermometers provide non-contact temperature measurements up to 4500°F. They offer effective solutions for many non-contact temperature applications, including the following:

- **Predictive Maintenance:** Tracking temperature shifts which indicate pending failure in solenoid valves.
- **Energy Auditing:** Locating wall insulation voids to reduce building heating costs.
- **Food Processing:** Taking accurate temperature readings without direct contact with the food or packaging material.

The IR thermometer provides information at a glance — the custom backlit dual digital LCD displays both current and minimum, maximum, average or differential temperatures. This versatile instrument provides:

- Measurable target distances from 5 inches to approximately 100 feet
- Emissivity adjustable from 0.1 to 1.00 in 0.01 steps provides ease of use when measuring a variety of surfaces.
- Built-in Laser sighting in Circle & Dot configurations.
- Thermocouple input available.
- An electronic trigger lock feature set via the keypad allows continuous temperature measurement up to 4 times per second.
- Audible and visual alarms. The high and low alarm points are set via the keypad.
- 1 mV per degree (°F or °C) analog output, which allows interfacing with data acquisition equipment (including chart recorders, dataloggers and computers). OS524 provides 0.5 mV/Deg.
- Last temperature recall.
- Backlit display useful in low ambient light conditions.
- Powers from 4 AA size batteries or an ac adapter.
- RS232 serial communication to a PC or printer. This allows downloading data for further analysis.
- Ambient target temperature compensation. This provides more accuracy for measuring low emissivity targets.
- Record up to 100 temperature data points. Review the recorded data on the thermometer LCD, as well as downloading the data to a PC.



The thermometer is easy to use:

- Units have standard “V” groove aiming sights.
- Integral tripod mount permits hands-free operation, if necessary.
- Temperature readings are switchable from °F to °C via the keypad.
- Parameters, such as target material emissivity and alarm setpoints, can be set and remain in memory until reset.

This instrument has a rugged and functional design, including:

- Sealed keypad display.
- Convenient trigger operation.
- Soft carrying case and wrist strap, for safety and ease of carrying.
- Rubber boot around the lens and the display.

**Table 1-1. OS530 Series Handheld Infrared Thermometer Features**

<b>Features</b>	<b>OS531</b>	<b>OS532</b>	<b>OS533</b>	<b>OS534</b>
Accuracy*	±2% rdg	±1% rdg	±1% rdg	±1% rdg
Range	0 to 750°F (-18 to 400°C)	0 to 1000°F (-18 to 538°C)	0 to 1000°F (-18 to 538°C)	0 to 1600°F (-18 to 871°C)
Emissivity	adjustable	adjustable	adjustable	adjustable
Backlit Dual Display	standard	standard	standard	standard
Distance to Spot Size Ratio	10:1	10:1	20:1	30:1
Differential Temperature	standard	standard	standard	standard
Min/Max Temperature	standard	standard	standard	standard
Average Temperature	standard	standard	standard	standard
High Alarm	standard	standard	standard	standard
Thermocouple Input	—	standard	standard	standard
Audible Alarm & Indicator	standard	standard	standard	standard
Analog Output	1 mV/deg	1 mV/deg	1 mV/deg	1 mV/deg
Built-in Laser Sighting	dot/circle	dot/circle	dot/circle	dot/circle
Trigger Lock	standard	standard	standard	standard
Last Temperature Recall	standard	standard	standard	standard
Low Alarm	—	—	standard	standard
Ambient Target Temperature Compensation	—	—	standard	standard
RS232 Interface	—	—	standard	standard
Data Storage	—	—	—	standard

Features	OS530L	OS530HR	OS530L-CF	OS533-CF	OS534-CF
Accuracy*	±1% rdg	3°F (1.7 °C)	±1% rdg	±1% rdg	±1% rdg
Range	-18 to 538°C 0 to 1000°F	-30 to 121°C -22 to 250°F	-18 to 538°C 0 to 1000°F	-18 to 538°C 0 to 1000°F	-18 to 871°C 0 to 1600°F
Emissivity	Adjustable	Adjustable	Adjustable	Adjustable	Adjustable
Display Resolution	1°F or 1°C	0.1°F or 0.1°C	1°F or 1°C	1°F or 1°C	1°F or 1°C
Backlit Dual Display	std	std	std	std	std
Field of view	10:1	20:1	.15"@6"	.15"@6"	.15"@6"
Differential Temperature	std	std	std	std	std
Min/Max Temperature	std	std	std	std	std
Average Temperature	std	std	std	std	std
High Alarm	std	std	std	std	std
Low Alarm	---	---	---	std	std
Audible Buzzer & Indicator	std	std	std	std	std
Ambient Target Temp Compensation	---	---	---	std	std
Analog Output	1 mV/Deg	1 mV/Deg	1 mV/Deg	1 mV/Deg	1 mV/Deg
RS232 Output	---	---	---	std	std
Data Storage	---	---	---	---	std
Built-in Laser sighting	Dot/Circle	Dot/Circle	Dot	Dot	Dot
Trigger Lock	std	std	std	std	std
Last Temperature Recall	std	std	std	std	std
Thermocouple Input	---	---	---	std	std

\* The temperature accuracy is 1% or 2% of Rdg or 3°F (2°C) whichever is greater.

# 1

## General Description

Features	OS523**	OS524
Accuracy	±1%rdg	±1% rdg
Range	0 to 2500°F (-18 to 1371°C)	1000 to 4500°F (538 to 2482°C)
Emissivity	adjustable	adjustable
Backlit Dual Display	standard	standard
Distance to Spot Size Ratio	varies**	110:1
Differential Temperature	standard	standard
Min/Max Temperature	standard	standard
Average Temperature	standard	standard
High Alarm	standard	standard
Low Alarm	standard	standard
Audible Alarm & Indicator	standard	standard
Ambient Target Temperature Compensation	standard	standard
Analog Output	1 mV/deg	0.5 mV/deg
RS-232 Output	standard	standard
Thermocouple Input	—	—
Data Storage	standard	standard
Built-in Laser Sighting	standard	standard
Trigger Lock	standard	standard
Last Temperature Recall	standard	standard

\*\* OS523 provides three field of views:

	Distance to Spot Size Ratio
<b>OS523-1</b>	30:1
<b>OS523-2</b>	60:1
<b>OS523-3</b>	68:1

## 1.2 Parts of the Thermometer

### 1.2.1 Front of the Thermometer

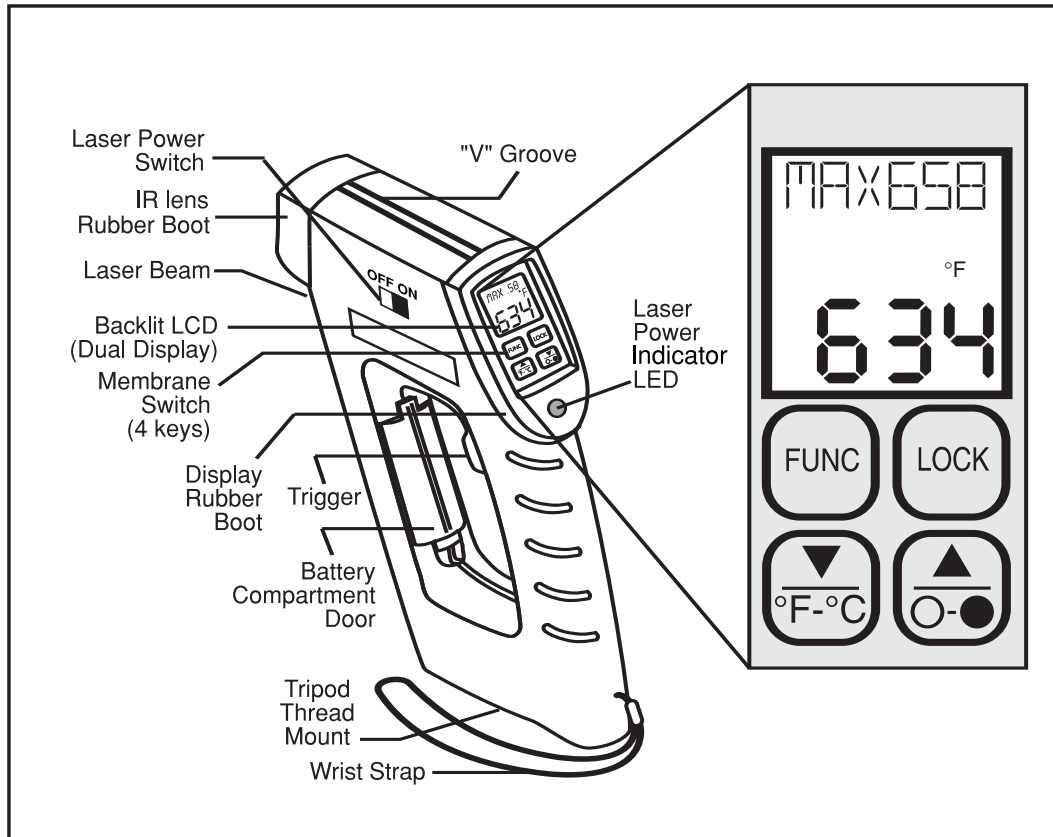

Figure 1-1. OS530/OS520 Series Handheld Infrared Thermometer Front View

The display is shown in more detail in Figure 1-2 and described in Table 1-2.

There are no user-serviceable parts in the thermometer.

Refer to Chapter 3 for Laser Sight information.

# 1 General Description

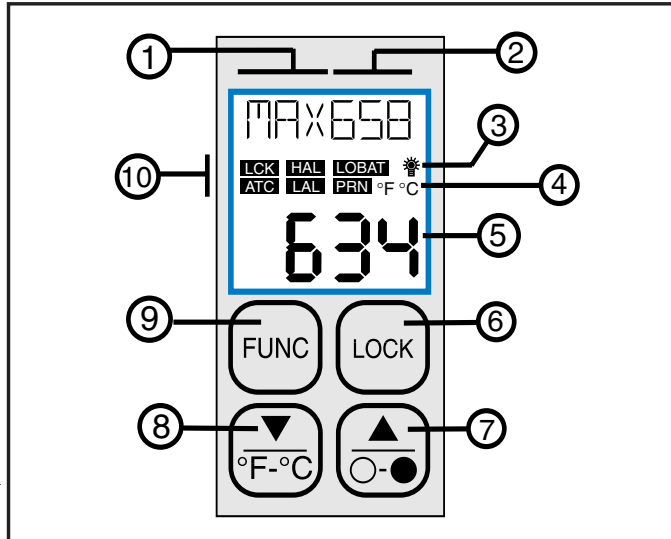

Figure 1-2. Display and Keypad View

Table 1-2. Display Details

Key	Description												
①	Display Mode displays one of the following: <table border="0" style="width: 100%;"> <tr> <td><b>E</b> (Emissivity)</td> <td><b>TC</b> (Thermocouple Input)</td> </tr> <tr> <td><b>MAX</b> (Maximum Temperature)</td> <td><b>HAL</b> (High Alarm Setpoint)</td> </tr> <tr> <td><b>MIN</b> (Minimum Temperature)</td> <td><b>LAL</b> (Low Alarm Setpoint)</td> </tr> <tr> <td><b>dIF</b> (Differential Temperature)</td> <td><b>AMB</b> (Ambient Target Temp)</td> </tr> <tr> <td><b>AVG</b> (Average Temperature)</td> <td><b>PRN</b> (Print Data)</td> </tr> <tr> <td></td> <td><b>MEM</b> (Store Temperature Data)</td> </tr> </table>	<b>E</b> (Emissivity)	<b>TC</b> (Thermocouple Input)	<b>MAX</b> (Maximum Temperature)	<b>HAL</b> (High Alarm Setpoint)	<b>MIN</b> (Minimum Temperature)	<b>LAL</b> (Low Alarm Setpoint)	<b>dIF</b> (Differential Temperature)	<b>AMB</b> (Ambient Target Temp)	<b>AVG</b> (Average Temperature)	<b>PRN</b> (Print Data)		<b>MEM</b> (Store Temperature Data)
<b>E</b> (Emissivity)	<b>TC</b> (Thermocouple Input)												
<b>MAX</b> (Maximum Temperature)	<b>HAL</b> (High Alarm Setpoint)												
<b>MIN</b> (Minimum Temperature)	<b>LAL</b> (Low Alarm Setpoint)												
<b>dIF</b> (Differential Temperature)	<b>AMB</b> (Ambient Target Temp)												
<b>AVG</b> (Average Temperature)	<b>PRN</b> (Print Data)												
	<b>MEM</b> (Store Temperature Data)												
②	Data associated with one of the Display Modes												
③	Backlighting Icon - allows the display to be viewed under low ambient light												
④	Displays the units of measure in either °F or °C												
⑤	Main display - displays the current temperature												
⑥	Locks the trigger / Enables or Disables alarms												
⑦	▲ for incrementing data; ○-● is for turning on/off the backlighting												
⑧	▼ for decrementing data; °F-°C is for changing the units of measure from °F to °C or vice versa												
⑨	Function key for scrolling through the display modes												
⑩	Display Icons <table border="0" style="width: 100%;"> <tr> <td><b>LCK</b> Trigger Lock</td> <td><b>LAL</b> Low Alarm</td> </tr> <tr> <td><b>ATC</b> Ambient Target</td> <td><b>LOBAT</b> Low Battery</td> </tr> <tr> <td><b>HAL</b> High Alarm</td> <td><b>PRN</b> Print Data</td> </tr> </table>	<b>LCK</b> Trigger Lock	<b>LAL</b> Low Alarm	<b>ATC</b> Ambient Target	<b>LOBAT</b> Low Battery	<b>HAL</b> High Alarm	<b>PRN</b> Print Data						
<b>LCK</b> Trigger Lock	<b>LAL</b> Low Alarm												
<b>ATC</b> Ambient Target	<b>LOBAT</b> Low Battery												
<b>HAL</b> High Alarm	<b>PRN</b> Print Data												

**LAL, AMB, PRN:** OS533, OS534, OS523, OS524

**TC:** OS532, OS533, OS534

**MEM:** OS534, OS523, OS524

### 1.2.2 Rear of the Thermometer

Figure 1-3 shows the various jacks that are used to connect a recorder or the ac adapter to the thermometer. The figure also shows the location of the tripod thread mount used for fixed point monitoring. More details are provided in Section 2.2.1.

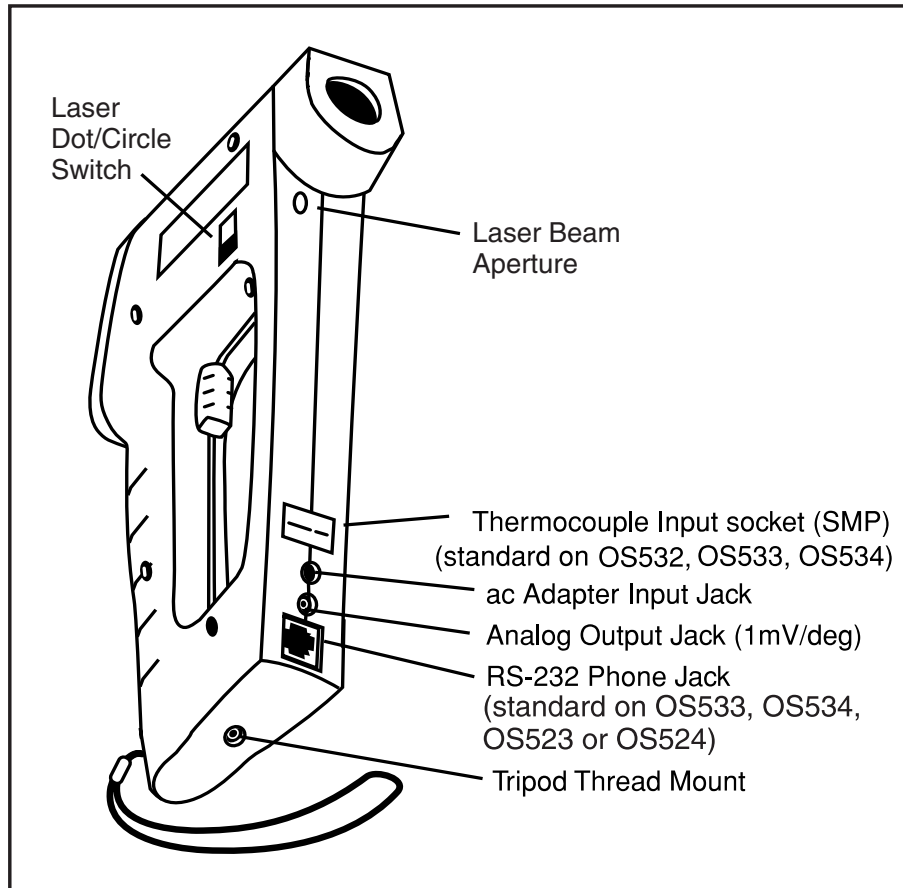

Figure 1-3. OS530 Series Handheld Infrared Thermometer Rear View



## 2.1 How to Power the Thermometer

### 2.1.1 Battery Operation

Invert the thermometer and install 4 fresh AA size batteries as shown in Figure 2-1. Make sure the batteries' polarities are correct, the batteries are not put in backwards, and are of the same type.

#### NOTE

If the **LOBAT** icon flashes, the batteries must be replaced with fresh batteries immediately.

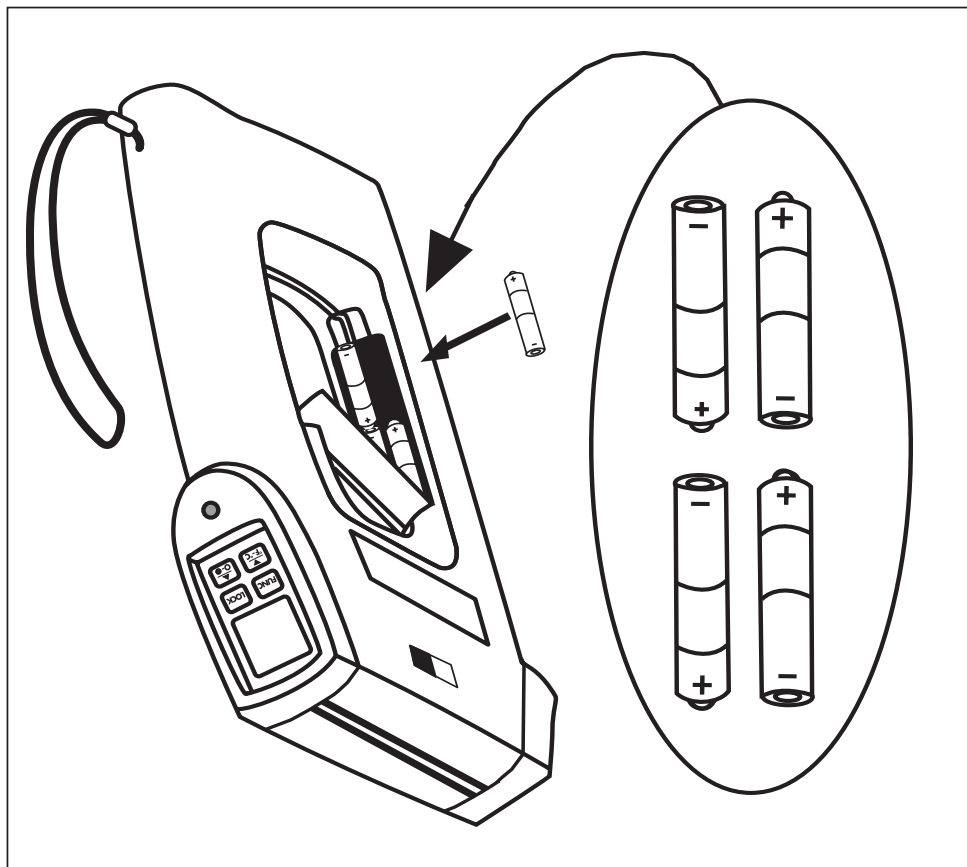

Figure 2-1. Installing the Batteries

### 2.1.2 ac Power Operation

The thermometer may be operated on ac power using the optional ac adapter. 120Vac/60 Hz and 220Vac/50 Hz adapters are available. When operating on ac power the batteries supply backup power in case of ac power failure. The ac adapter input jack is shown in Figure 1-3.



## 2.2 Operating the Thermometer

- 1a. (Without the Laser Sighting) - Aim the thermometer at the target to be measured. Use the "V" groove (shown in Figure 1-1) on top of the thermometer to align the target to the thermometer's field of view. Look down the "V" groove with one eye only, in order to guarantee proper sighting. Pull and hold the trigger.
- 1b. (With the Laser Sighting) - Set the laser power switch to the ON position. Aim at the target and pull the trigger. The laser beam and the red power indicator LED will turn on while the trigger is pulled. Refer to Chapter 3 for more details on the Laser Sighting.

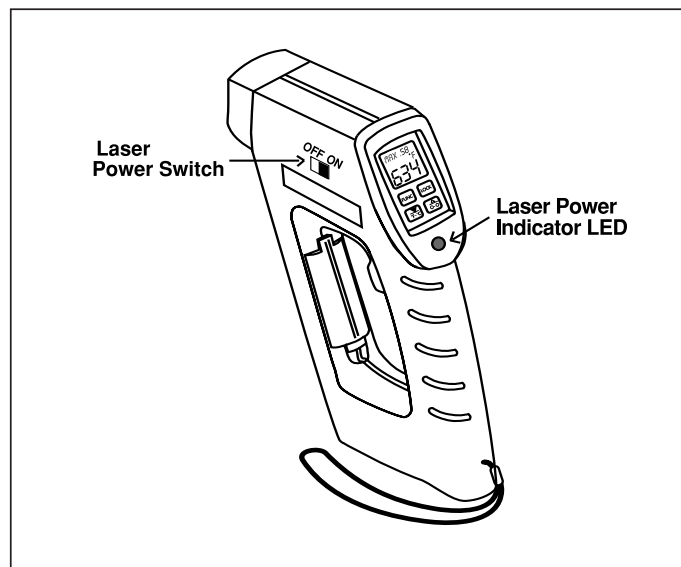

Figure 2-2. OS530/OS520 Series with Built-in Laser Sighting

2. The field of view of the thermometer should fall within the area of the target being measured. See Figure 2-3. Figures 2-4 through 2-6 show the field of view vs distance for the various thermometers.

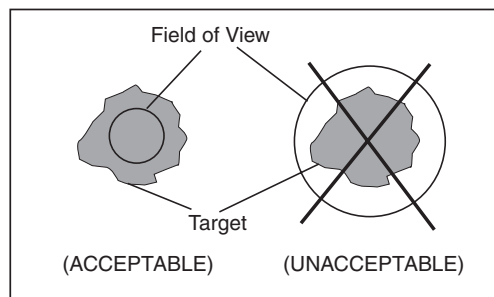

Figure 2-3. Field of View Positions

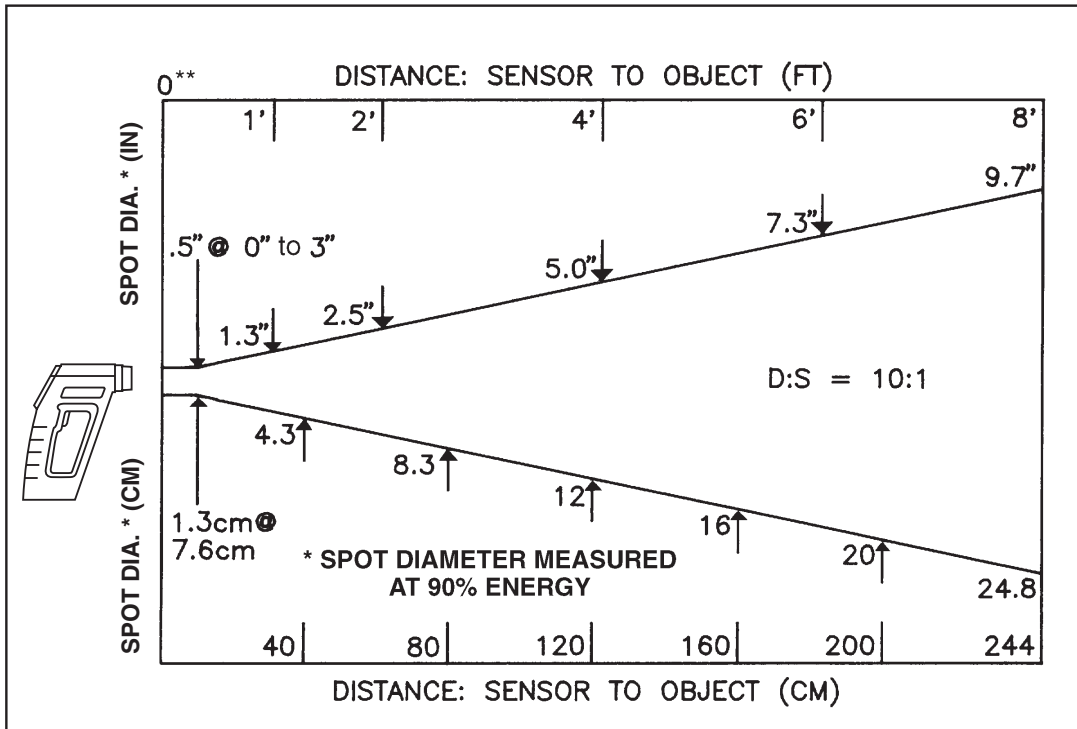

Figure 2-4. Field of View OS531, OS532, OS530L

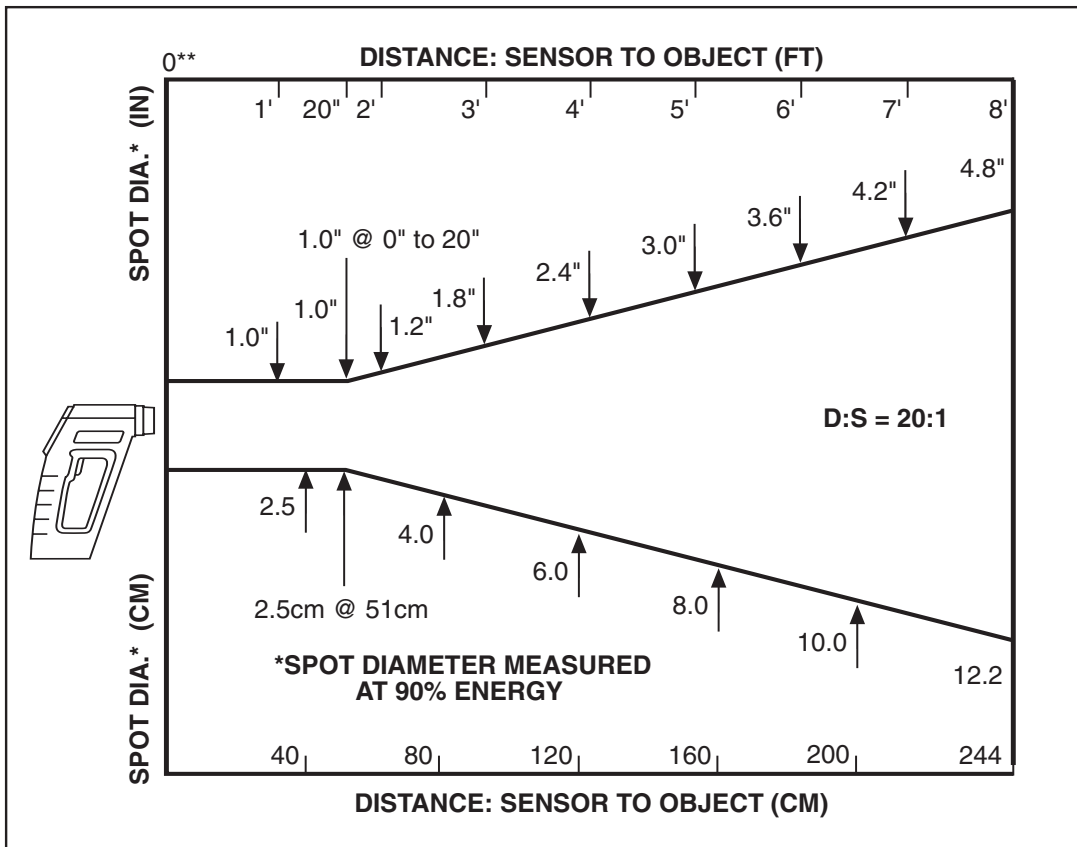

Figure 2-5 Field of View OS533, OS530HR

\*\* Measurement distance is from the outside surface of the rubber boot.

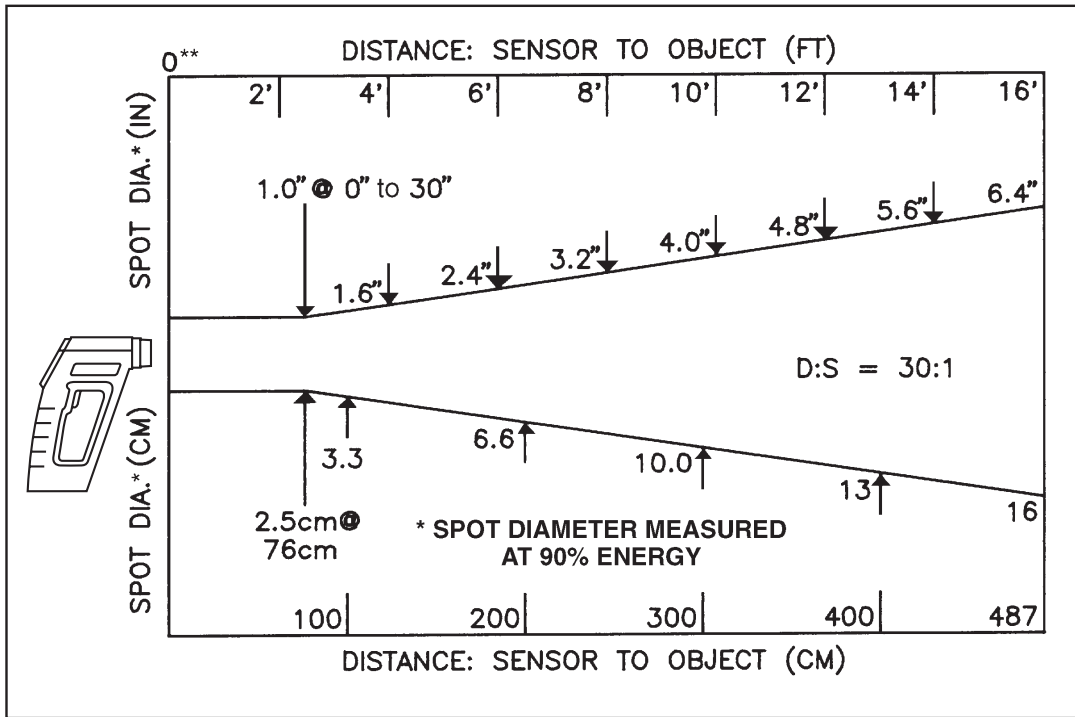

Figure 2-6 Field of View OS534, OS523-1

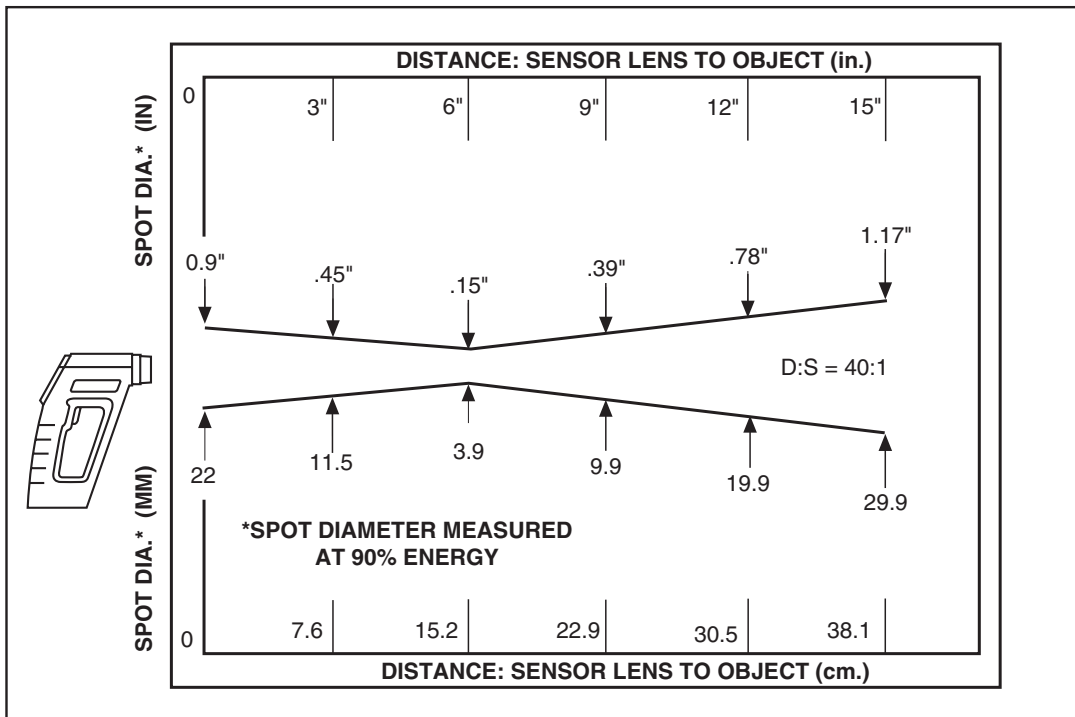

Figure 2-7 Field of View OS53x-CF

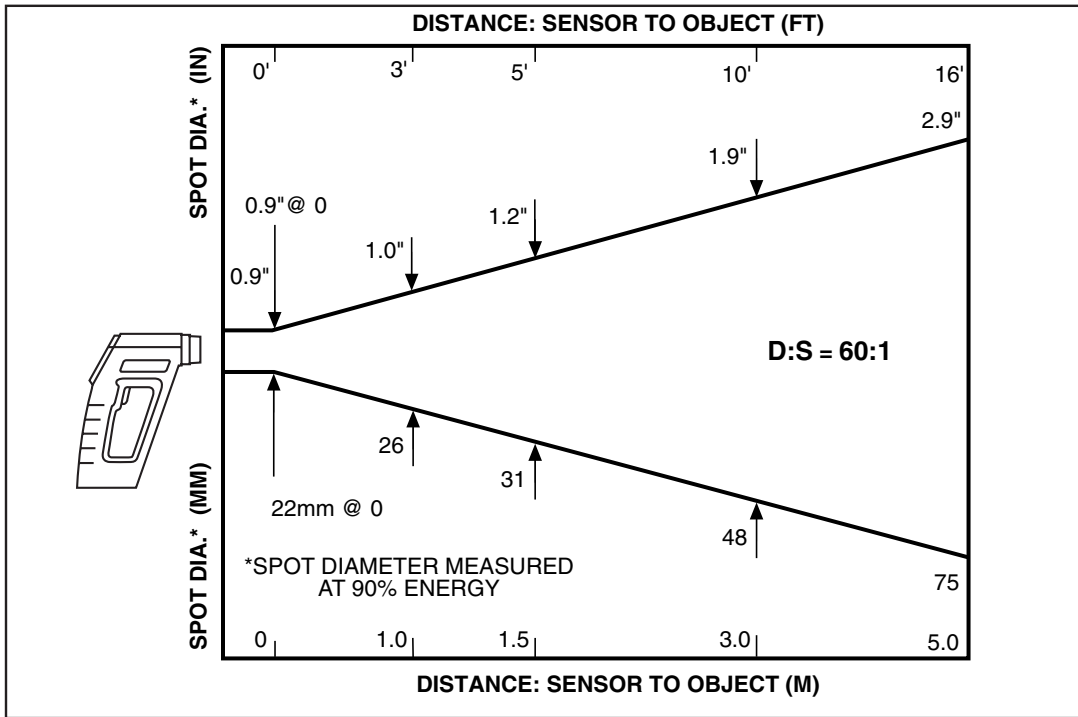

Figure 2-8 Field of View OS523-2

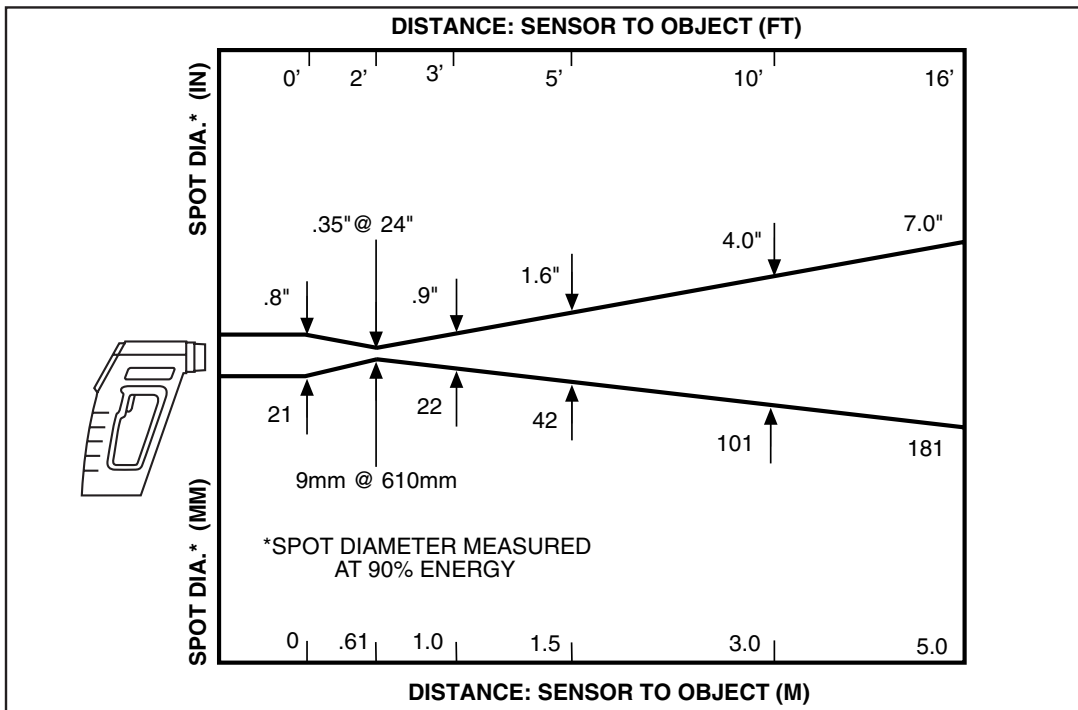

Figure 2-9 Field of View OS523-3

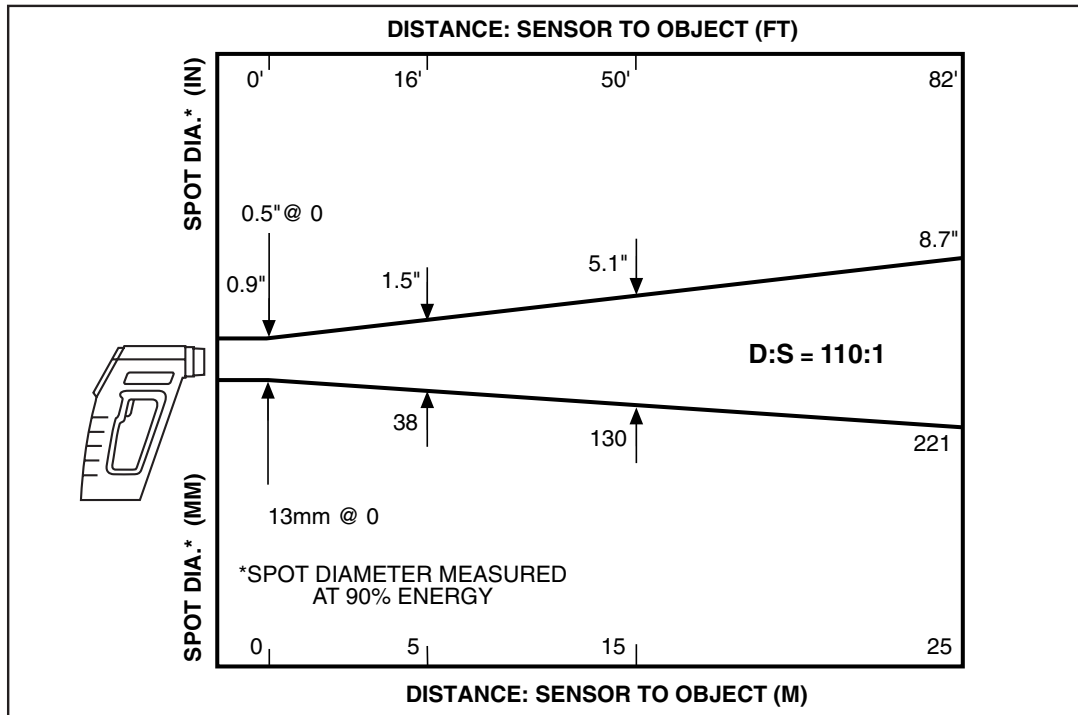















Figure 2-10 Field of View OS524

3. The target temperature and emissivity are displayed on the LCD. Determine the emissivity of the target (refer to Appendix B). Press the  key to increment the target emissivity. Press the  key to decrement the target emissivity.
4. Press the  key to lock the trigger. The  icon will appear on the display. This allows the thermometer to operate continuously whether or not the trigger is pulled. To unlock the trigger, press the  key again. The  icon is no longer displayed. When the trigger is pulled, the Laser Sighting as well as the display backlight will stay on .
5. After completing a temperature measurement, release the trigger. In order to conserve battery life, the thermometer goes into sleep mode and the Laser Sighting turns off.

### 2.2.1 Measurement Techniques

You can use the IR Thermometer to collect temperature data in any one of five different ways:

- **Spot Measurement** — Measures the temperature of discrete objects such as motor bearings, engine exhaust manifolds, etc.:
  1. Aim at the desired target and pull the trigger.
  2. If necessary, adjust the emissivity using the  and  keys.
  3. Read the temperature.
- **Differential Measurement** — Measures the temperature differential between two spots (the maximum and minimum temperatures viewed)
  1. Aim the thermometer at the first spot and pull the trigger. Press the  key to lock the trigger.
  2. If necessary, adjust the emissivity.
  3. Aim at the second spot.
  4. Adjust the emissivity of the second spot if required.
  5. To display the differential temperature, press the  key until "dIF" appears on the display.
  6. Read the differential temperature from the upper display.
  7. Press the  key to unlock the trigger.
- **Static Surface Scan** – Measures the temperature across a static surface:
  1. Aim the thermometer at a starting point and pull the trigger. Press the  key to lock the trigger.
  2. If necessary, adjust the emissivity.
  3. Slowly move the thermometer so that the line of sight sweeps across the surface. The thermometer measures the temperature at each point on the surface.
  4. To record the temperature profile across the surface, connect the IR thermometer to a strip chart recorder. Refer to Figure 2-7 for details. The IR thermometer provides an analog output of 1 mV/degree. (0.5 mV/Deg on OS524)
  5. After all the data has been taken, press the  key to unlock the trigger.

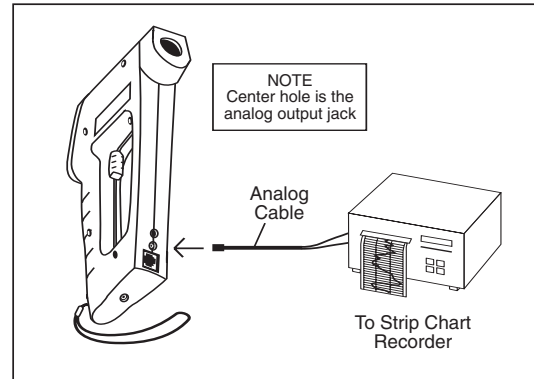

Figure 2-11 Recorder Hookup

- **Moving Surface Scan** - Measures the Temperature of Points on a Moving Surface:
  1. Mount the thermometer on a camera tripod and aim at a fixed point on the moving surface.
  2. Pull the trigger and press the **LOCK** key to lock the trigger.
  3. If necessary, adjust the emissivity. The thermometer is now set up for measuring the temperature of a moving surface.
  4. To record the temperature profile of the moving surface, connect the IR thermometer to a strip chart recorder. Refer to Figure 2-11 for details.
  5. After all data is taken, press the **LOCK** key to unlock the trigger.
- **Fixed Point Monitoring Over Time** - Monitors the temperature at a fixed point over time:

**NOTE**

It is recommended that you use the ac adapter for long term measurement of temperature.

1. Mount the thermometer on a camera tripod and aim at the target.
2. Connect the analog output of the thermometer to a strip chart recorder as shown in Figure 2-11.
3. Pull the trigger and press the **LOCK** key to lock the trigger.
4. If necessary, adjust the emissivity.
5. The thermometer is now set up for unattended monitoring of temperature over time. You can also download the temperature to a Serial Printer or a PC for further analysis (Models OS533, OS534, OS523, OS524).
6. After all data is taken, press the **LOCK** key to unlock the trigger.

### 2.3 Real Time Mode (Active Operation)

Definition: Real Time Mode is the active operational mode of the thermometer. In this mode, the thermometer constantly measures and displays temperature.

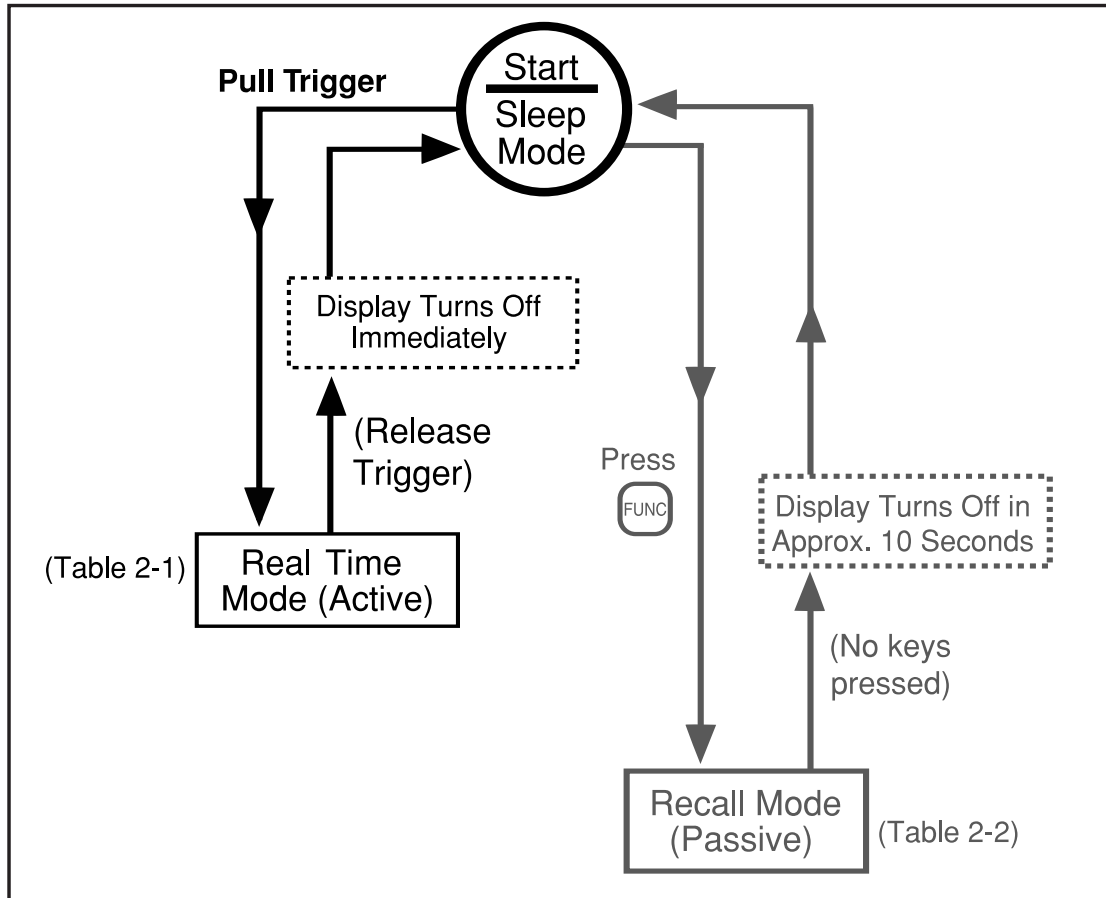

Figure 2-12. General Operational Block Diagram

#### NOTE

If the trigger is pulled two times in rapid sequence, it may reset the emissivity, high alarm, low alarm and target ambient temperature to the default values.



Table 2-1. Functional Flow Chart when the Trigger is Pulled (Real Time Mode)

Recall Mode					
DISPLAY MODE:	Display shows:	Press <b>FUNC</b> to...	Press <b>LOCK</b> to...	Press <b>°F/°C</b> or <b>▲/●</b> to...	
<b>E</b>	Last temperature Emissivity	Go to <b>MAX</b>	Disabled	Disabled	Set memory location
<b>MAX</b>	Last temperature Maximum temperature	Go to <b>MIN</b>			
<b>MIN</b>	Last temperature Minimum temperature	Go to <b>DIF</b>			
<b>DIF</b>	Last temperature Differential temperature	Go to <b>AVG</b>			
<b>AVG</b>	Last temperature Average temperature	Go to <b>TTC</b>			
<b>TTC</b>	Last temperature Thermocouple temperature	Go to <b>HRL</b>			
<b>HRL</b>	Last temperature High alarm setpoint	Go to <b>LAL</b> or <b>E</b>			
<b>LAL</b>	Last temperature Low alarm setpoint	Go to <b>AMB</b>			
<b>AMB</b>	Last temperature Ambient target temperature	Go to <b>PRN</b> or <b>E</b>			
<b>PRN</b>	Last temperature	Go to <b>MEM</b>			
<b>MEM</b>	Last/stored temperature Memory location	Go to <b>E</b>			

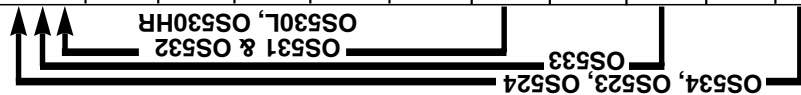

**NOTE: The unit of measure (°F or °C) stays on (does not flash) during Recall Mode.**

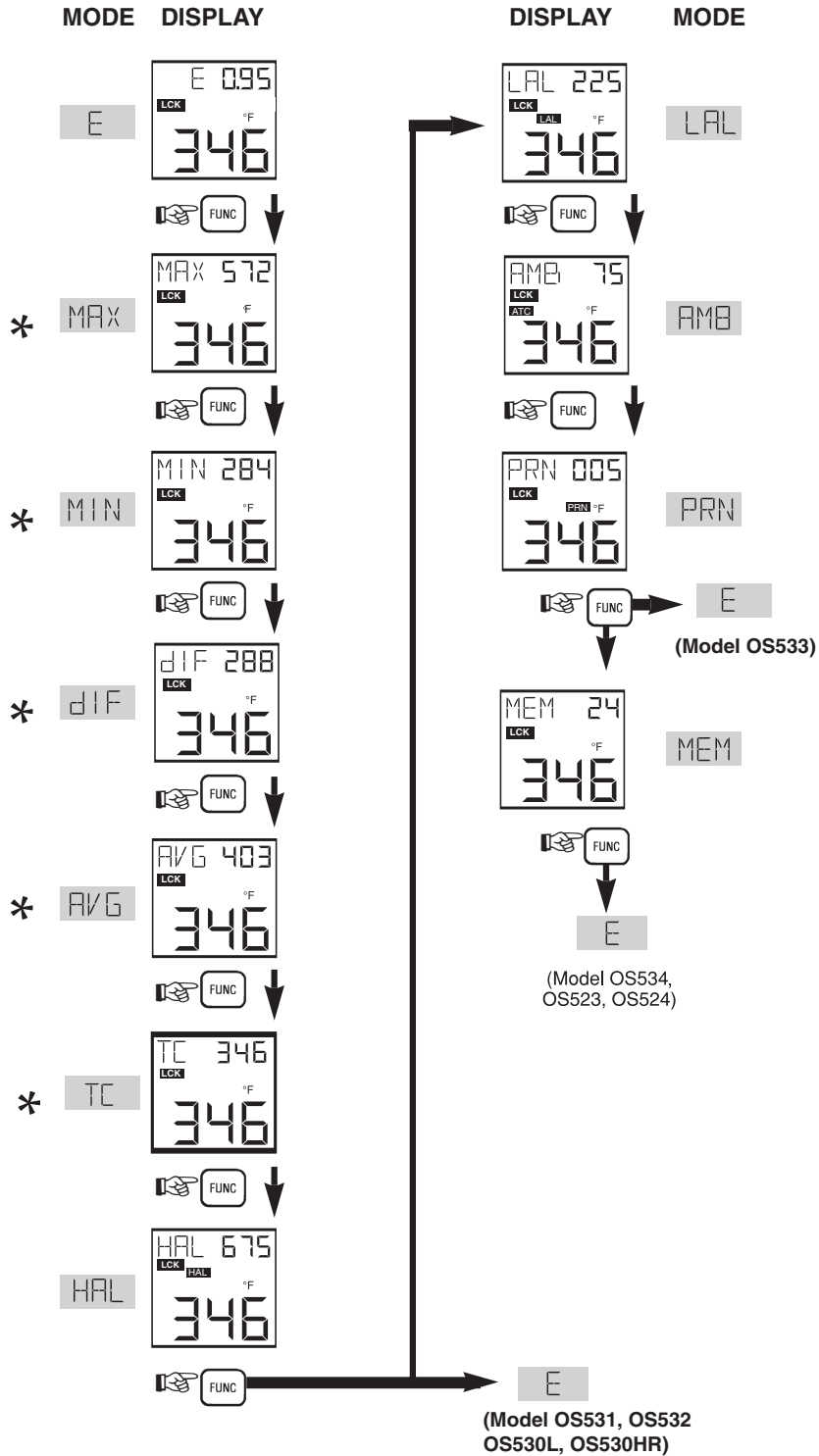

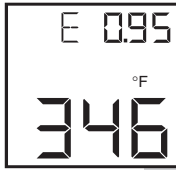



Figure 2-13. Visual Function Flow Chart

\* While in these 5 modes:  
 Use  key to change temperature from °F to °C or vice versa.  
 Use  key to turn on the display backlighting.

### 2.3.1 Adjusting Emissivity



Refer to Appendices B and C for information on emissivity.

1. Determine the emissivity of the target.
2. Aim at the target and pull the trigger.
3. If necessary, press the  key to increment the target emissivity or press the  key to decrement the target emissivity.

#### NOTE



The Emissivity Display Mode (E) appears every time the trigger is pulled regardless of how the Display Mode was previously set.

#### NOTE



The emissivity setting does not change when the thermometer is turned off. However, when the batteries are replaced, the emissivity is reset to 0.95, the default value.

### 2.3.2 Using the LOCK Function

This function electronically locks the trigger mechanism:

1. Pull the trigger and press the  key to lock the trigger. The  icon will appear on the display.
2. Release the trigger. This allows the thermometer to operate continuously whether or not the trigger is pulled.

#### NOTE

To unlock the trigger function, press the  key again, and the  icon is no longer displayed.

### 2.3.3 Calculating Temperature Values

The thermometer calculates the MAX, MIN, dIF, and AVG temperatures based on the current temperature.

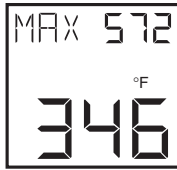

is the maximum temperature since the temperature measurement session starts (pulling the trigger).

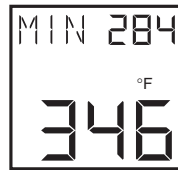

is the minimum temperature since the temperature measurement session starts.

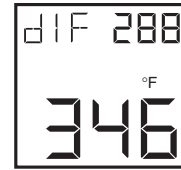

is the difference between the MAX and MIN temperatures.

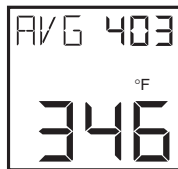

is the true average temperature since the temperature measurement session starts. The average temperature under continuous operation is accurate for a limited period of time (refer to the specifications). However, the AVG temperature function can be used indefinitely when the thermometer is operating intermittently.

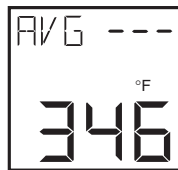

“AVG ---” is displayed when either of the following conditions occur:

1. When the average temperature measurement reaches its time period as stated in the specifications.
2. When the thermometer is trying to measure a target temperature which is outside of its measuring temperature range.

To clear the “AVG ---” display, turn off the thermometer.

#### NOTE

Every time the thermometer goes from the sleep mode to the Real Time mode (by pulling the trigger) the MAX, MIN, dIF, AVG and TC temperatures are updated.

### 2.3.4 Changing the Temperature from °F to °C (or vice versa)

During the time that the thermometer displays either MAX, MIN, dIF, AVG or thermocouple temperatures, press the  key to change all the temperatures from °F to °C or vice versa.



### 2.3.5 Turning on the Display Backlighting

During the time that the thermometer displays either MAX, MIN, dIF, AVG or thermocouple temperatures, press the  key to turn the display backlighting ON/OFF while the unit is in LOCK mode and trigger is released. In addition, the display backlight turns on automatically when the trigger is pulled.

### 2.3.6 Thermocouple Input (OS532, OS533, OS534)

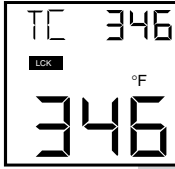
The thermometer accepts thermocouple input. It displays thermocouple temperature and the target temperature (via infrared) simultaneously. This function provides an accurate method of determining an unknown emissivity.



- To Determine an unknown target emissivity
  1. Connect a contact thermocouple probe (Type K) to the thermometer as shown in Figure 1-3.
  2. Measure the object temperature using the thermocouple probe.
  3. Aim at the object and measure the temperature via infrared.
  4. Press and hold the  key until the Emissivity Display mode (E) appears.
  5. Set the emissivity by pressing the  or  keys until the temperature reading matches the thermocouple temperature measurement.
  6. The thermometer now displays the correct object emissivity.

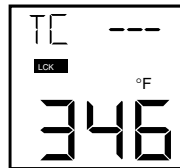

"TC--- is" is displayed when the thermocouple input is open or out of range (0 to 1600°F).

### 2.3.7 Using the Alarm Functions

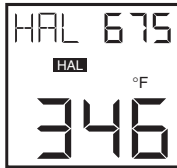

The thermometer provides audible and visible alarm indications.

- To set the high alarm value:
  1. Pull the trigger. Then press and hold the **FUNC** key until the High Alarm Display Mode (HAL) appears.
  2. Press the **▲** key to increment the high alarm value. Press the **▼** key to decrement the high alarm value.
  3. Press the **LOCK** key to enable the high alarm function. The **HAL** icon appears.

If the temperature exceeds the high alarm setpoint, you will hear a beep and the **HAL** icon on the display flashes.

4. To disable the high alarm, press the **LOCK** key again, and the **HAL** icon disappears.

#### NOTE

If you are not in High Alarm Display Mode (HAL) when the high alarm goes off, you must press the **FUNC** key to get into the High Alarm Display Mode. Then press the **LOCK** key to disable the high alarm.

#### NOTE

The high alarm setpoint does not change when the thermometer is turned off. However, when the batteries are replaced, it is reset to the default value as follows:

OS530HR:	250°F
OS531:	750°F
OS530L, OS532, OS533:	1000°F
OS534:	1600°F
OS523:	2500°F
OS524:	4500°F



- To set the low alarm value: (OS533, OS534, OS523, OS524):

1. Pull the trigger. Then press and hold the **FUNC** key until the Low Alarm Display Mode (LAL) appears.
2. Press the **▲** key to increment the low alarm value. Press the **▼** key to decrement the low alarm value.
3. Press the **LOCK** key to enable the low alarm function. The **LAL** icon appears.

If the temperature drops below the low alarm setpoint, you will hear a beep and the **LAL** icon on the display flashes.

4. To disable the low alarm, press the **LOCK** key again, and the **LAL** icon disappears.

#### NOTE

If you are not in Low Alarm Display Mode (LAL) when the low alarm goes off, you must press the **FUNC** key to get into the Low Alarm Display Mode. Then press the **LOCK** key to disable the low alarm.

#### NOTE

The low alarm setpoint does not change when the thermometer is turned off. However, when the batteries are replaced, it is reset to the default value of 0°F (1000°F for OS524).

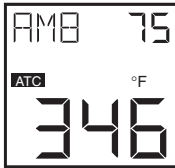

### 2.3.8 Using Ambient Target Temperature Compensation (OS533, OS534, OS523, OS524)



Use the Ambient Target Temperature Compensation (AMB) Display Mode when high accuracy readings under both of these conditions are required:

- The target has a low emissivity.
- The ambient temperature around the target is much higher than the ambient temperature around the infrared thermometer.

To set and activate the Ambient Target Temperature Compensation Mode:

1. Pull the trigger and press the **LOCK** key to lock the trigger. Set the emissivity to 1.0 (refer to Section 2.3.1).
2. Press and hold the **FUNC** key until the Average Display Mode (AVG) appears.
3. Slowly move the thermometer so that the line of sight sweeps across the area surrounding the target. The thermometer measures the temperature at each point on the surrounding area.
4. Read the average temperature value from the upper display and record it here \_\_\_\_\_.
5. Press and hold the **FUNC** key until the Ambient Temperature Display Mode (AMB) appears.
6. Set the AMB temperature found in Step 4 by pressing the  key or the  key.
7. Press the **LOCK** key to enable the ambient target temperature compensation. The **ATC** icon appears on the display.

#### NOTE

To disable this mode, press the **LOCK** key again. The **ATC** icon disappears.





8. Press and hold the **FUNC** key until the Emissivity Display Mode (E) appears.
9. Change the emissivity to the proper value for the target being measured (refer to Section 2.3.1).
10. Aim at the target. The target temperature and emissivity are displayed on the LCD.
11. After all data is taken, press the **LOCK** key to release this mode

---

**NOTE**

---

To disable the Ambient Target Temperature Compensation at a later time, you must press the **FUNC** key to get into the Ambient Target Temperature Display Mode. Then press the **LOCK** key to disable it.

---



---

**NOTE**

---

The target ambient temperature does not change when the thermometer is turned off. However, when the batteries are replaced, it is reset to the default value of 75°F.

---

### 2.3.9 Sending Temperature Data to a Serial Printer (OS533, OS534, OS523, OS524)

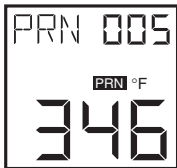

The thermometer can transmit temperature data to a Serial Printer via the RS-232 phone jack and the RS-232 cable.

1. Turn on the Serial Printer and set the following parameters:
 

Speed: 4800 BPS	One Stop Bit
Data: 8 Bits	No Parity
2. Connect the RS-232 cable between the thermometer and the printer as shown in Figure 2-14.

PRN 005  
346

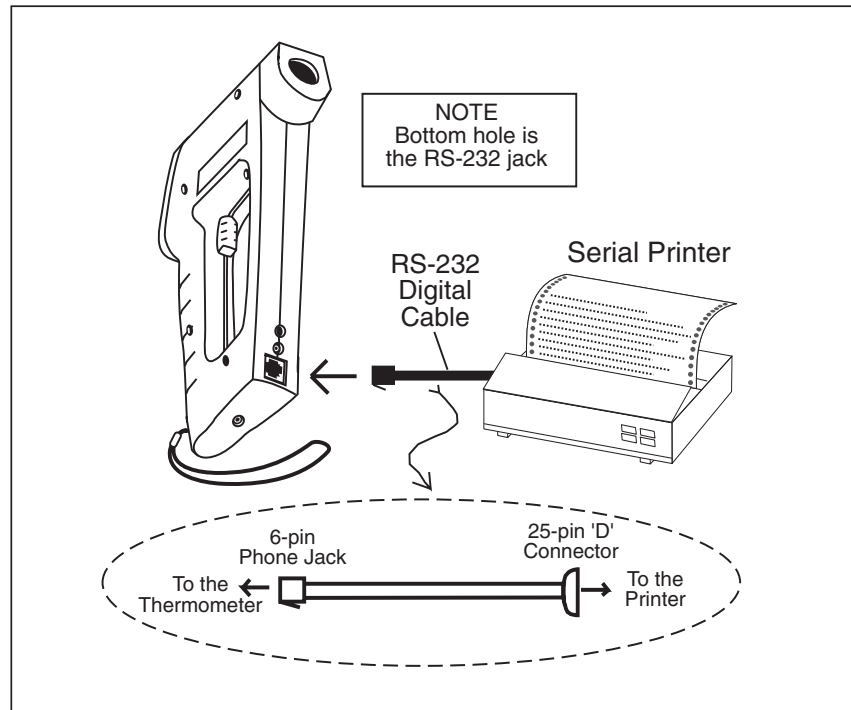

Figure 2-14. Serial Printer Hookup

3. Pull the trigger and press the **LOCK** key to lock the trigger. The **LLK** icon will appear on the display.
4. Press and hold the **FUNC** until the Print Data display Mode (PRN) appears.
5. Press the **▲** key to increment the printing interval. Press the **▼** key to decrement the printing interval. The printing interval (from 1 to 1999 seconds) is the time between data points. The default value is 2 seconds.
6. Press the **LOCK** key to start sending data. The **PRN** icon appears on the display.

**NOTE**

To stop sending data, press the **LOCK** key again, and the **PRN** icon disappears.



7. After all data is taken, press the **LOCK** key again and the **PRN** icon disappears.
8. Press and hold the **FUNC** until the Emissivity display Mode (E) appears.
9. Press the **LOCK** key to unlock the trigger.

### 2.3.10 Sending Temperature Data to a Personal Computer (OS533, OS534, OS523, OS524)

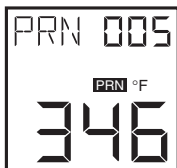

The thermometer can transmit temperature data to a Personal Computer via the RS-232 phone jack and the RS-232 cable.

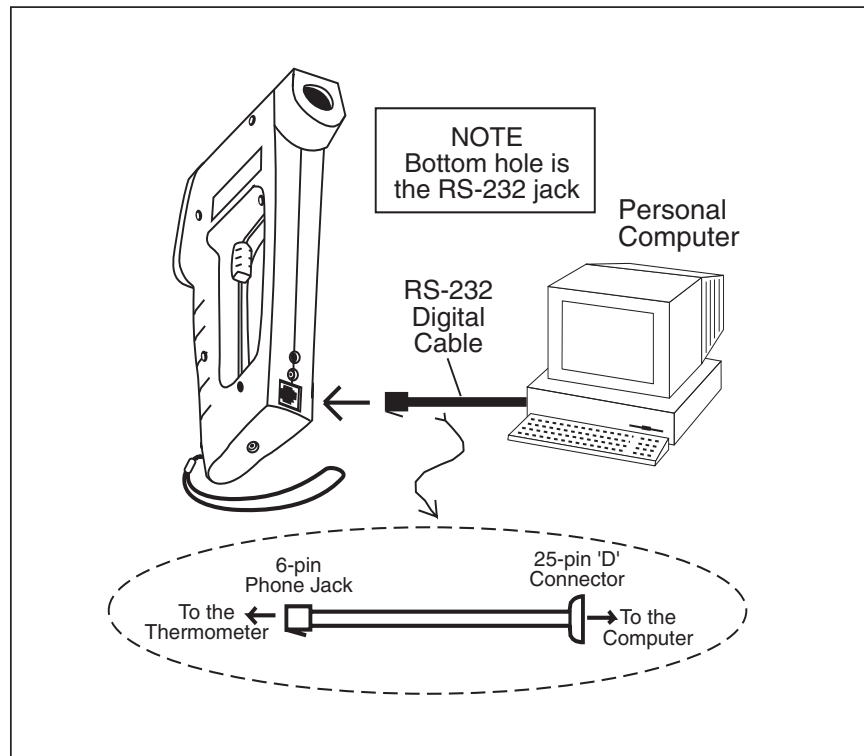

Figure 2-15. Personal Computer Hookup

#### 2.3.10.1 Software Installation

##### System Requirements

To run IR\_TEMPSOFT you must have an IBM-compatible personal computer with these minimum specifications:

Operating System:	Win95, Win98, Win NT 4.0, Windows 2000
Processor :	Pentium Class (Any speed)
Ram:	32 Mega-Bytes
Monitor:	VGA, Or Higher Resolution
Video Card:	Supports VGA, 256 Color, 800 x 600 Resolution (Minimum)
CommPort:	4800 Baud, 8 Databits, 1 Stop, No Parity.
CD-ROM:	Any Speed
Hard Drive:	10 Mega-Bytes Available Space (For Installation Only)

### How to Install IR\_TEMPESOFT

Please follow this installation procedure to install IR\_TEMPESOFT:

1. Place the supplied CD disk into your CD-ROM drive. Make certain that you are not running any other applications at this time. Running other applications while trying to install IR\_TEMPESOFT may cause installation errors.
2. The CD will automatically start.
3. Click on Free Software. Then Click on the Software icon.
4. Now you will see a menu of Free software download for different products.
5. Click on the Infrared Thermometer picture icon. This will start the installation process.
6. Follow the installation instructions as they appear on your screen. For example, you will be asked in which directory would you like to install the IR\_TEMPESOFT program. You may accept the default location provided, ("C:\Program Files\IR\_TEMPESOFT\") or specify your own location.
7. During the process of installation, the installer program will notify you if it is about to overwrite an existing file with one that is older. Should this occur, it is advisable to keep your newer files and do not overwrite them with the supplied older files.
8. After a successful installation, the installer program will notify you with a pop-up which states "IR\_TEMPESOFT from Omega Engineering Setup was completed successfully." Just click on the "OK" button.

If you have any trouble with the installation of this

program please contact technical support at Omega Engineering Inc.

### **Connecting the IR-System to the PC**

Make certain that your Infrared Thermometer is powered down before you attempt to make any connections to the personal computer. Making connections between powered devices and a powered PC can cause damage to communications ports, or other electronic circuitry in your device or computer.

1. With the thermometer device powered down, connect the enclosed serial communications cable to the device.
2. Connect the other end of the serial cable to the desired communications port of the personal computer. Usually, it is located in the back of the unit.
3. Pull the trigger and press the  key to turn on the thermometer. Point the thermometer to your target, and make certain that you are reading a temperature. Do not begin to print (send) data at this time.



### **Starting The IR\_TEMP\_SOFT Software**

1. From your desktop, click on the "Start" Button.
2. Locate, and click on the "Programs" selection. A side menu will appear listing all application programs that can be run on the computer.
3. Locate and click on the "IR\_TEMP\_SOFT" folder.
4. Click on "IR\_TEMP\_SOFT" to start the program.

### **Receiving Real-Time Temperature Data**

1. After the splash screen is displayed and disappears, you will be left at the main panel of the program.
2. Here you will select the "Command" menu item from the main menu bar, which will cause a drop down menu to appear. Select "Send Data In Real Time" to begin receiving data.
3. A popup will appear showing a computer searching for an IR Device with the caption "Scanning CommPort for IR Transmission". This is normal, as the program is now

waiting for the thermometer to transmit data through your RS-232 port.

4. Begin transmitting data from the thermometer by pressing and holding the  key on the thermometer until the Print Data Display Mode (PRN) appears.
5. Press the "UP" key to increment the printing interval. Press the "Down" key to decrement the printing interval. The printing interval (from 1 to 1999) is the time between data points. The default value is 2 seconds.
6. Press the  key on the thermometer to begin transmitting data. The "PRN" icon appears on the thermometer display. You should now see the current temperature, the downloaded parameters, and the temperature data being charted.

If instead the "Scanning CommPort for IR Transmission" popup is still visible, then there is a communications error. Check the communications cable, and its connection at both the IR device and computers comm-port. Make certain that you are connected to your configured comm-port.

From the main menu, click on Help, and select On-Line Manual. The on-line Manual has more detailed information regarding all the features of the software.

To stop the data transmission from the thermometer, press the  key and the PRN icon will disappear.

---

**NOTE**





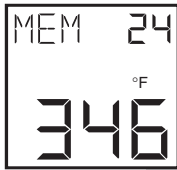

The transmitter temperature data is the average temperature for every printing interval period.

---

### 2.3.11 Storing the Temperature Data on Command (OS534, OS523, OS524)





The thermometer can store up to 100 temperature data points on command. Each set of temperature data is broken down into the temperature value, emissivity, and high alarm setpoint for that temperature. This data is stored in non-volatile memory, so removing the batteries will not affect this data. To store temperature data:

1. Aim at the target and pull the trigger and press the  key to lock the trigger. The **LOCK** icon will appear on the display.
2. If necessary, press the  key to increment the target emissivity or press the  key to decrement the target emissivity.
3. Press and hold the  key until the Memory Display Mode (MEM) appears.
4. Press the  key to increment the memory location or press the  key to decrement the memory location. The memory location can be from 001 to 100.
5. Press the  key to store the target temperature at the memory location indicated. You will hear a beep to verify that the data is stored.





#### NOTE

You can write over any previously stored memory locations.

6. After all data is taken, press and hold the  key until the Emissivity Display Mode (E) appears.
7. Press the  key to unlock the trigger.

### 2.3.12 Erasing the Temperature Data from Memory

The user can erase all 100 temperature data points in memory at any time by using the following procedure:

1. Pull the trigger and press the  key. The  icon will appear.
2. Press the  and  keys in rapid sequence.

---

**NOTE**

---

If the  icon disappeared, repeat steps 1 and 2

---

The display freezes momentarily, and a beep sounds for about 1 second. Now the memory is cleared. The thermometer reverts to real time mode.

---

**NOTE**

---

Erasing the temperature data does not erase or reset Emissivity, High and Low Alarm setpoints, printing interval and Ambient Target Temperature compensation

---

3. After all data is erased from memory, press the  key to unlock the trigger.



## 2.4 Recall Mode (Passive Operation)

Definition: Recall Mode is the passive operational mode of the thermometer. In this mode, you may review the most recently stored temperature data and parameters.

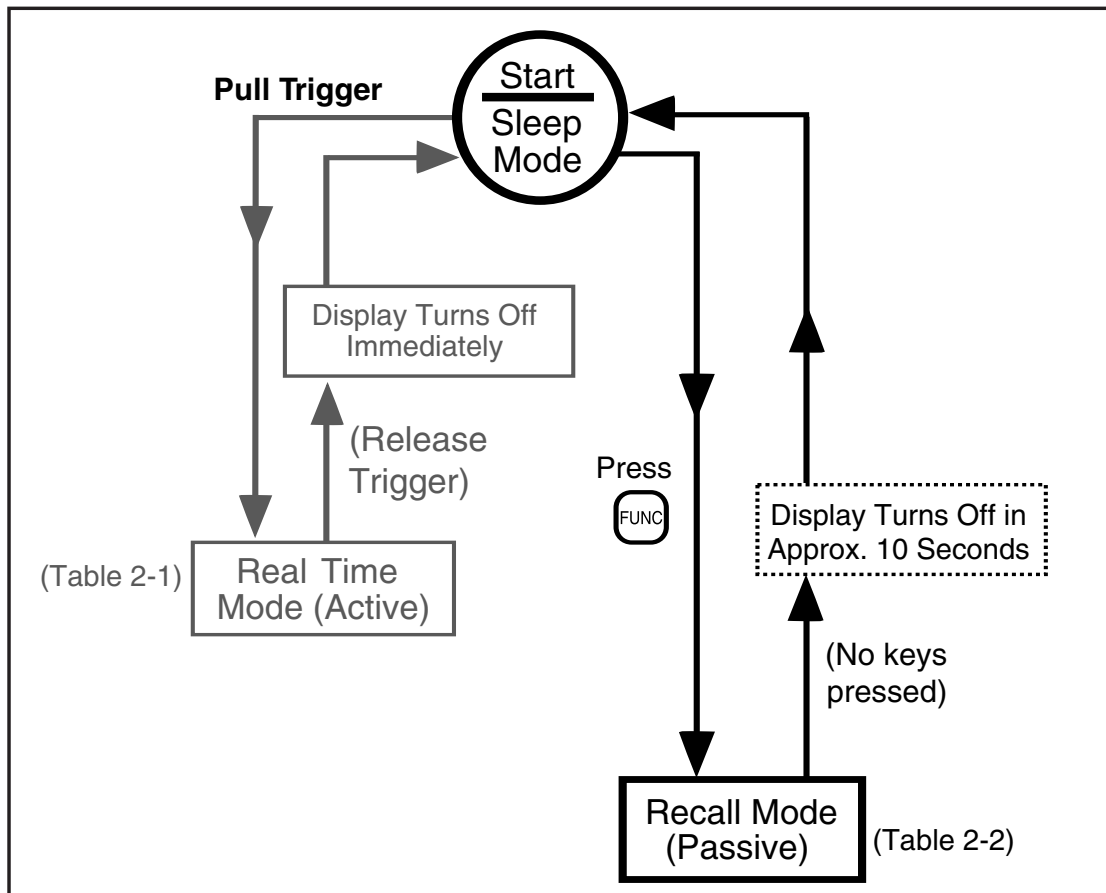

Figure 2-16. General Operational Block Diagram

### NOTE

In order to get into the Recall Mode of operation, press the  key only. Do not pull the trigger; otherwise, you will get into the Real Time (Active) Mode of operation.

Table 2-2. Functional Flow Chart (Recall Mode)

Recall Mode				
DISPLAY MODE:	Display shows:	Press FUNC to...	Press LOCK to...	Press °F/°C or to...
E	Last temperature Emissivity	Go to MAX	Disabled	Disabled
MAX	Last temperature Maximum temperature	Go to MIN		
MIN	Last temperature Minimum temperature	Go to DIF		
DIF	Last temperature Differential temperature	Go to AVG		
AVG	Last temperature Average temperature	Go to TC		
TC	Last temperature Thermocouple temperature	Go to HRL		
HRL	Last temperature High alarm setpoint	Go to LAL or E		
LAL	Last temperature Low alarm setpoint	Go to AMB		
AMB	Last temperature Ambient target temperature	Go to PRN or E		
PRN	Last temperature	Go to MEM		
MEM	Last/stored temperature Memory location	Go to E		
				Set memory location

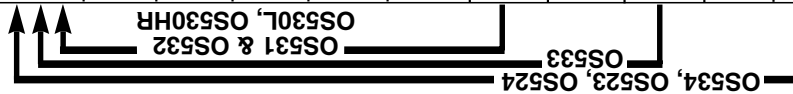

**NOTE: The unit of measure (°F or °C) stays on (does not flash) during Recall Mode.**

### 2.4.1 Reviewing the Last Parameters

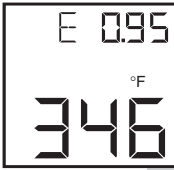

The thermometer stores the last temperature measured in the real time mode (refer to Table 2-1). This temperature can be recalled by pressing the **FUNC** key.

- Press the **FUNC** key to review the most recently stored temperature data and parameters. You may review:

- |  |   |                   |
|--|---|-------------------|
| <ul style="list-style-type: none"> <li>• MAX temperature</li> <li>• MIN temperature</li> <li>• dIF temperature</li> <li>• AVG temperature</li> <li>• TC temperature</li> </ul> | } | Calculated values |
| <ul style="list-style-type: none"> <li>• HAL temperature</li> <li>• LAL temperature</li> <li>• AMB temperature</li> <li>• MEM location</li> </ul>                              | } | Set values        |

### 3.6.2 Downloading Previously Stored Temperature Data (OS534, OS523, OS524)

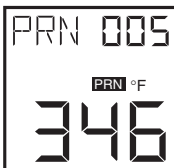

Up to 100 sets of stored temperature information can be downloaded to a serial printer or a personal computer. Each set of temperature information is broken down to the temperature value, the Emissivity, and the high alarm setpoint for that temperature.



- 1a. Turn on the Serial Printer and set the following parameters:

Speed: 4800 BPS  
 Data: 8 Bits  
 One Stop Bit  
 No Parity

or

- 1b. Turn on the Personal Computer.
2. Connect the RS-232 cable between the thermometer and the Serial Printer or Personal Computer as shown in Figure 2-14 or Figure 2-15.





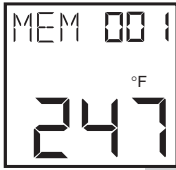

3. To download stored temperature data points from the thermometer, first make certain that it is not in printing mode. Make sure that the IR\_TEMP\_SOFT is installed properly as explained in section 2.3.10.
4. On the main menu bar, click on "Command-> Download Stored Data". The "Stored Data" window will appear.
5. The "Stored Data Points" window will appear.
6. Click on the "START RECEIVING" button to bring the program into receive mode. Release the trigger to put the thermometer into sleep mode.
7. Press and hold the  key until you see the Print Display Mode (PRN) appear.
8. Press the  key to start downloading the stored data to the Personal Computer. The "PRN" icon appears on the thermometer display. When the stored data is completely downloaded, you will hear a peep and the "PRN" icon disappears.
9. When the thermometer completes sending all its memory content, a pop-up will appear.
10. From the "STORED DATA" window you can save the display data to a text file or directly export it into a MS Excel file.

The on-line Manual has more detailed information on all the features of this software.

### 2.6.3 Reviewing Previously Stored Temperature Data (OS534, OS523, OS524)



You can review all 100 stored temperature values on the thermometer display using the following procedure:

1. Press and hold the  key until you see the Memory Display Mode (MEM) appear.
2. Press the  key to increment the memory location or press the  key to decrement the memory location. The memory location can be from 001 to 100.
3. Press the  key. The stored temperature is shown in the lower portion of the display. If there is no data stored in a memory location, the display shows "----".
4. To review other stored temperatures, repeat Steps 2 and 3.

#### NOTE

If no keys are pressed, the thermometer goes into sleep mode in approximately 10 seconds.

---

### 3.1 Warnings and Cautions

---

**CAUTION**

---

You may receive harmful laser radiation exposure if you do not adhere to the warnings listed below:

- **USE OF CONTROLS OR ADJUSTMENTS OR PERFORMANCE OF PROCEDURES OTHER THAN THOSE SPECIFIED HERE MAY RESULT IN HAZARDOUS RADIATION EXPOSURE.**
- DO NOT LOOK AT THE LASER BEAM COMING OUT OF THE LENS OR VIEW DIRECTLY WITH OPTICAL INSTRUMENTS - EYE DAMAGE CAN RESULT.
- USE EXTREME CAUTION WHEN OPERATING THE LASER SIGHTING.
- NEVER POINT THE LASER BEAM AT A PERSON.
- KEEP OUT OF REACH OF ALL CHILDREN.

---

**WARNING**

---

DO NOT ATTEMPT TO OPEN THE LASER SIGHTING.  
(There are no user-serviceable parts in the module.)

---

Refer to the inside back cover for product warning label.

## 3.2 Description

The Laser Sighting is built into the thermometer. It provides a visual indication of the field of view of the thermometer. Aiming at distant targets (up to 40 feet) becomes much easier by using the Laser Sighting. It is offered in two different models, laser dot, and laser dot/circle switchable.

OS53x-CF and OS523-3 — Thermometer with built-in Laser Dot

All other models — Thermometer with built-in Laser Dot/Circle Switchable

Figures 3-1 and 3-2 show the rear and front view of the thermometer with the built-in laser sight module.

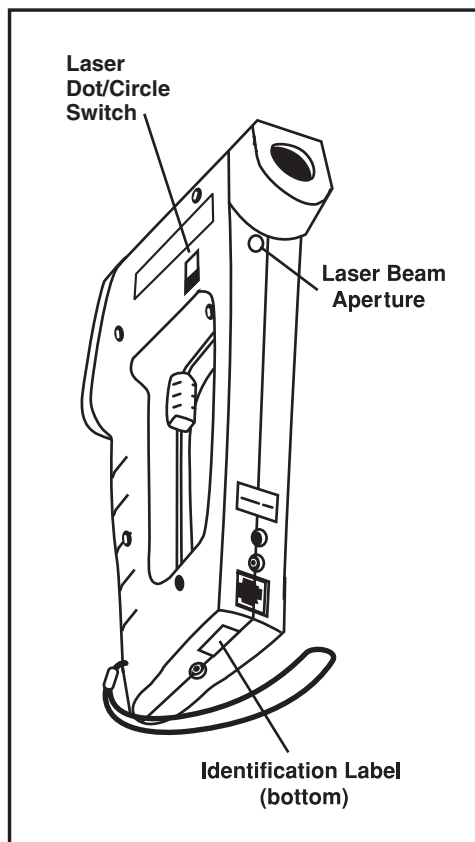

Figure 3-1. Rear View of the Thermometer

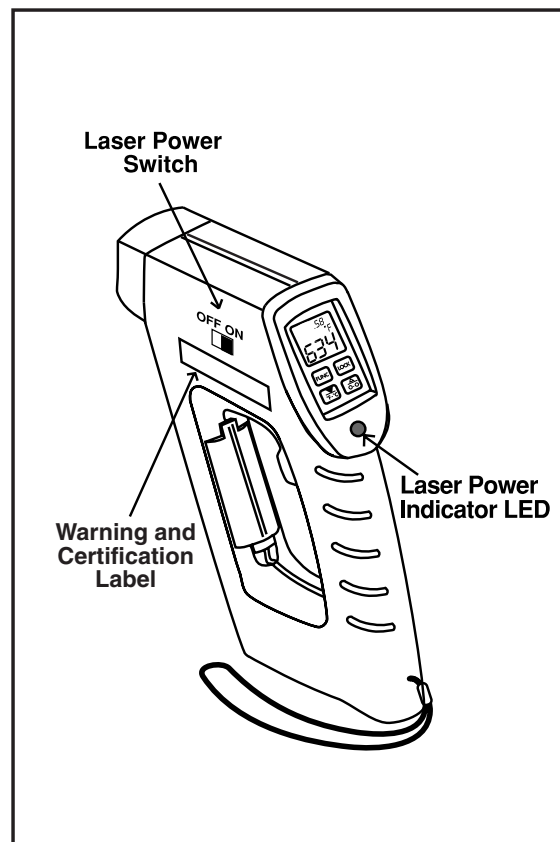

Figure 3-2. Front View of the Thermometer

### 3.3 Operating the Laser Sighting

1. Set the laser power switch to the ON position as shown in Figure 3-2.
2. Aim at the target and pull the trigger.
3. The laser beam and the red power indicator LED will turn on. Refer to Figure 3-1 and Figure 3-2.

The laser beam will stay on as long as the trigger is pulled. If the trigger is locked (the **LOCK** key is previously pressed) or released, the laser beam will turn off. In order to turn on the Laser Sighting again, pull the trigger again.

4. Depending on the model, the laser dot/circle switch allows the user to switch between laser dot and laser circle. The laser dot provides visibility at longer distances.

Figure 3-3 shows the two different laser configurations. The laser Dot indicates the center of the field of view of the thermometer. The laser Circle indicates the perimeter of the thermometer's field of view.

The visibility of the laser beam depends on the ambient light levels.

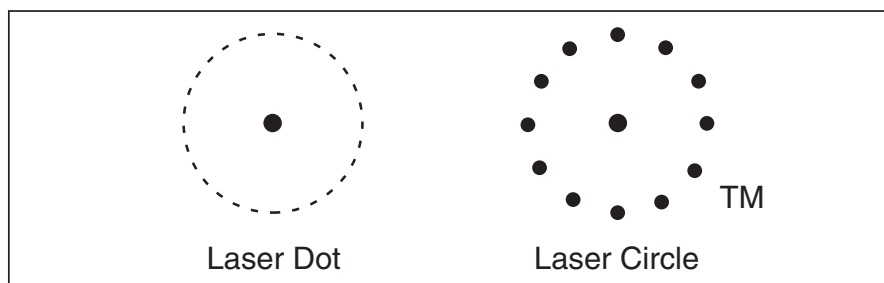

Figure 3-3. Two Laser Configurations



**NOTE**

The Laser Sighting turns on only when used with the thermometer. The module does not turn on by itself.

The line of sight of the thermometer does not coincide with that of the Laser Sighting, as shown in Figure 3-4. The two lines of sight become less critical when measuring distant targets. For example, at 30 feet from the target and a 3 foot diameter target size, there is a 2.7% offset error with respect to the target size. For close-up targets, first make sure the target fills the laser circle, then point it with the center of the beam approximately 1" below the center of the target. A simple method to make infrared measurements is to scan the laser beam across the target area vertically and horizontally and recall measurements of maximum for hot and minimum for cold target (compared to the background) to obtain the correct temperature.

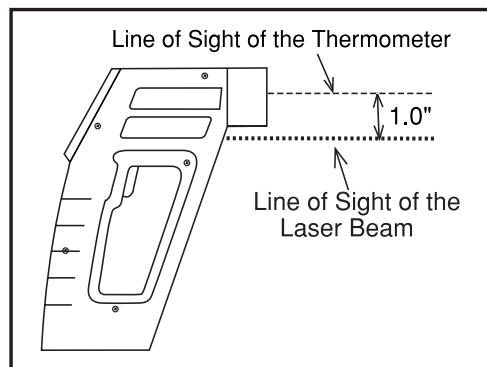

**Figure 3-4 Lines of Sight of the Laser Sighting and Thermometer**

## 4.1 Sighting Scope

The Sighting scope is an accessory for the thermometer. It provides a visual indication of the target being measured. Aiming at distant targets (up to 200 feet) becomes much easier by using the Sighting scope.

## 4.2 Installing and Operating the Sighting Scope

1. If the sighting scope is already installed on the thermometer, go onto step 5.
2. The sighting scope comes with a pair of mounting clamps already attached.
3. Slide the pair of mounting clamps over the "V" groove of the thermometer from back to front as shown in FIG 4-1. DO NOT remove the protective label from the laser sight power contacts.
4. Using the two mounting screws of the clamp, tighten the sighting scope to the pair of clamps and the thermometer.
5. Look through the sighting scope at an arm's length. You will see a crosshair indicating the center of the target being measured.
6. Aim at the target and pull the trigger.

Since the sighting scope mounts on top of the thermometer, the line of sight of the thermometer does not coincide with that of the sighting scope, as shown in Fig. 4-1. The distance between the two lines of sight ( $1\frac{1}{16}$ " ) becomes less critical compared to the target size when measuring distant targets (50 feet and longer).

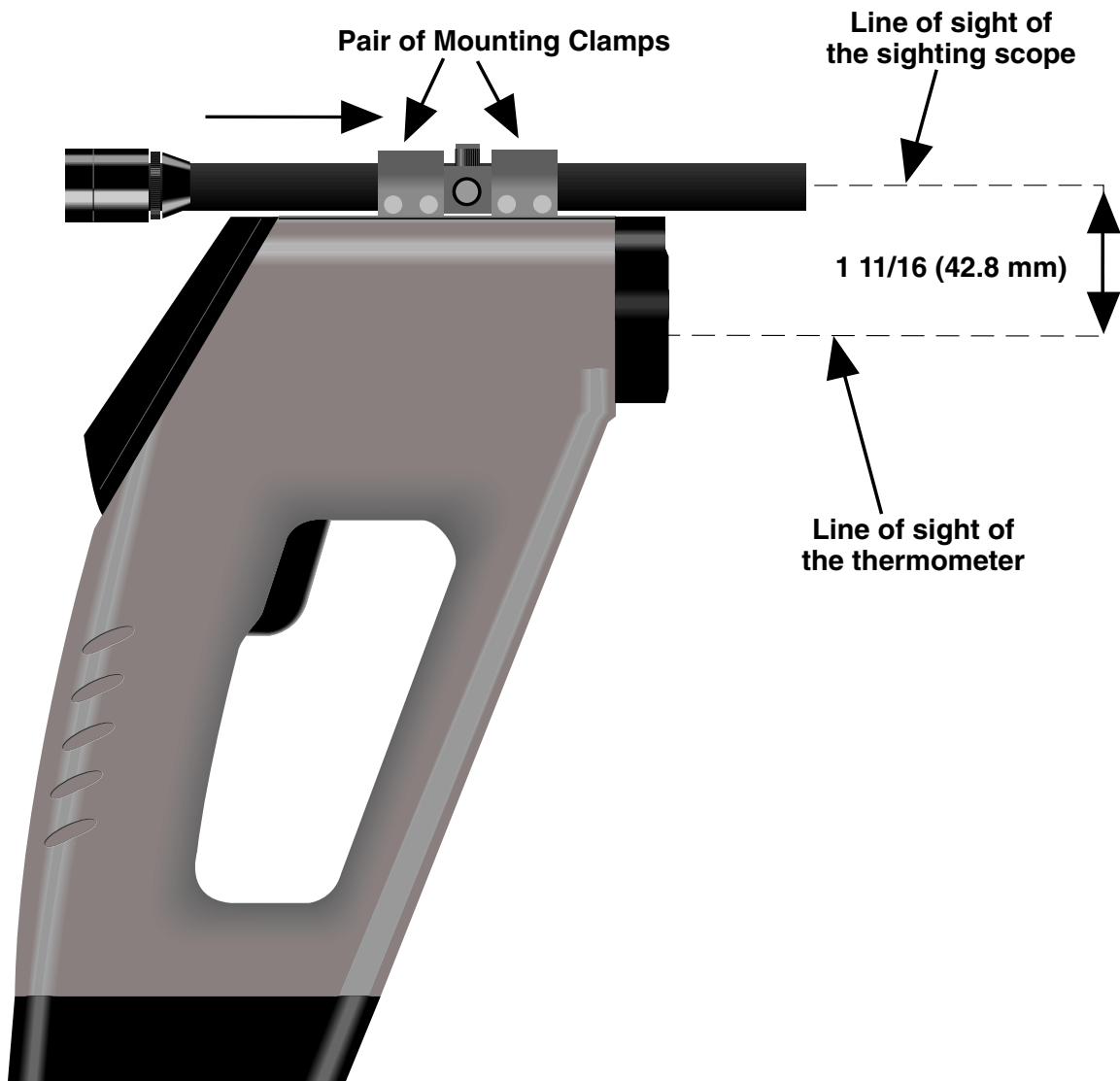

Figure 4-1. Installing the Sighting Scope

## 5.1 Replacing the Batteries

### NOTE

When you change the batteries, all of the set parameters (i.e. emissivity, high alarm, low alarm, Target Ambient Temperature) will be reset to the default values. For your convenience, you may want to write down all of the set parameters BEFORE replacing the batteries.

The thermometer is powered by 4 standard AA size lithium batteries. To replace the batteries:

1. Invert the thermometer and open the cover of the battery compartment.
2. Remove the old batteries.
3. Install 4 fresh AA size (lithium or alkaline) batteries as shown in Figure 2-1.
4. Close the battery compartment cover.

### NOTE

When the battery power is so low that accurate measurements are no longer possible, the thermometer shuts down and you must replace the batteries immediately.

You will see and hear the following:

- The **LOWBAT** icon flashes
- The thermometer beeps intermittently
- The thermometer flashes " **□□□** " in the main display.

### Safety Warning

Do not open batteries, dispose of in fire, heat above 100°C (212°F), expose contents to water, recharge, put in backwards, mix with used or other battery types – may explode or leak and cause personal injury.

## 5.2 Cleaning the Lens

Although all lenses are quite durable, take care to prevent scratching when cleaning them. To clean the lens:

1. Blow off loose particles, using clean air.
2. Gently brush off remaining particles, using a camel hair brush. Alternatively, clean any remaining contaminants with a damp, soft, clean cloth. Be careful not to rub too hard.

---

**CAUTION**

---

Do not use any ammonia or cleaners with ammonia on the lens, as damage may result. Do not wipe the surface dry, as this may cause scratching.

---



## 5.3 Calibrating the Thermometer



The thermometer can not be calibrated by the user. For precise calibration of the thermometer, call our Customer Service Department. It is recommended that the Infrared Thermometer to be sent to the factory once a year for recalibration.

## 5.4 Servicing the Laser Sighting

Servicing and maintenance is not required to keep the laser sighting in proper operating condition. In the event of a malfunction, the unit should be returned to the manufacturer for repair.

## THERMOMETER

Problem	Solution
<p>The thermometer does not turn on (No Display)</p>	<ol style="list-style-type: none"> <li>1a. Properly install fresh batteries.</li> <li>1b. If operating under ac power, check that the ac adapter is plugged in properly to the ac wall outlet and to the thermometer.</li> <li>1c. Make sure the batteries make good contact - remove and reinstall the batteries.</li> <li>2. Make sure that the trigger is pulled completely.</li> </ol>
	<ol style="list-style-type: none"> <li>1. Reset the thermometer. It sets all of the parameters to the default values and restores calibration. The procedure is as follows, when the thermometer is in sleep mode:               <ol style="list-style-type: none"> <li>a. Press and hold the  key.</li> <li>b. Pull the trigger.</li> <li>c. Release the trigger.</li> <li>d. Release the  key.</li> <li>e. The version of the software is displayed for about 1 second. The emissivity display mode immediately follows with the emissivity of 0.95.</li> </ol> </li> </ol>
<ul style="list-style-type: none"> <li>- The  icon flashes.</li> <li>- The thermometer beeps intermittently.</li> <li>- The thermometer flashes "□□□□" in the Main Display.</li> </ul>	<ol style="list-style-type: none"> <li>1. Properly install fresh batteries.</li> </ol>

Problem	Solution
The thermometer is "locked up" (the display is "frozen").	Remove and reinstall the batteries or disconnect and reconnect the ac adapter.
The display is either erratic or stays at one reading.	<ol style="list-style-type: none"> <li>1. Clean the thermometer lens. Refer to Section 4.2.</li> <li>2. Activate the Diagnostic Program in the thermometer as follows:               <ol style="list-style-type: none"> <li>a. Pull the trigger and press the  key to lock the trigger.</li> <li>b. Hold down the  key and press the  key until "VER X.X" is displayed.</li> </ol> </li> </ol> <p>You can expect to see and hear the following:</p> <ul style="list-style-type: none"> <li>• You will see the version number "VER X.X" of the software for about 1 second.</li> <li>• You will hear a beep, "TST" is displayed and °F flashes.</li> <li>• Soon after, all of the segments of the display including the backlighting will light up for about 1 second.</li> <li>• The display will clear and a PAS (pass) or ERR (error) code may be seen on the display.</li> </ul>



Problem	Solution
	<p>If you see an error code, either "ERR1", "ERR2", or "ERR3", record the code and call our Customer Service Department. Provide Customer Service with the error code that is displayed in the upper left corner of the display. The Customer Service Department representative may ask you to return the thermometer to the factory.</p> <ul style="list-style-type: none"> <li>• The display will go back to the Real Time Mode (Emissivity Display Mode).               <ul style="list-style-type: none"> <li>c. After running the diagnostic program, press the  key to unlock the trigger.</li> </ul> </li> </ul>
<p>The temperature reading is erratic. The thermometer has just been moved from one extreme temperature to room temperature [0°C or 50°C (32°F or 122°F)] or vice versa.</p>	<ol style="list-style-type: none"> <li>1. The thermometer has to stabilize before taking temperature measurements. It takes up to 40 minutes for the thermometer to stabilize.</li> </ol>
<p>The temperature reading is erratic. The thermometer has just been moved from room temperature (ambient temperature) to a temperature 10°C colder or warmer.</p>	<ol style="list-style-type: none"> <li>1. The thermometer has to stabilize before taking temperature measurements. It takes up to 20 minutes for the thermometer to stabilize.</li> </ol>





Problem	Solution
The thermometer resets itself unexpectedly. The emissivity has been reset to .95. All other parameters are reset to the default values.	The trigger is pulled two times in rapid sequence. Wait at least 2 seconds between two successive trigger pulls. You may need to set the emissivity, low alarm, high alarm, target ambient temperature values again.

### Laser Sighting

Problem	Solution
No Laser Beam	1. Make sure the trigger is pulled and the laser power switch is turned on. (The red power LED should be lit).
The Laser "line of sight" does not coincide with the center of the target.	1. The line of sight and the center of the target are offset by design. (refer to Figure 3-4 and the explanation above it for how to compensate for this).

(Specifications are for all models except where noted)

**THERMOMETER**

Measuring: Temperature Range:	OS530HR, OS531: OS530L, OS533, OS532: OS534 OS523 OS524	-22°F to 250°F (-30°C to 121°C) 0°F to 750°F (-18°C to 400°C) 0°F to 1000°F (-18°C to 538°C) 0°F to 1600°F (-18°C to 871°C) 0°F to 2500°F (-18°C to 1371°C) 1000°F to 4500°F (538°C to 2482°C)
Accuracy (24°C or 75°F Ambient Temperature and at emissivity of 0.95 or greater):	OS531: All others	±2% of reading or 3°F whichever is greater ±1% of reading or 3°F whichever is greater (2% Rdg for temp > 2000°F for OS524)
Field of Vision:	OS531, OS532, OS530L OS533, OS530HR OS534 OS53x-CF OS523-1 OS523-2 OS523-3 OS524	10:1 20:1 30:1 .15"@6" 30:1 60:1 68:1 110:1
Repeatability:		± (1% rdg + 1 digit)
Resolution:		1°F or 1°C (0.1°F or °C for OS530HR)
Response Time:		250 msec
Spectral Response:		8 to 14 microns (2 to 2.5 microns, OS524) (5 to 14 microns, OS530L, OS531, OS532)
Thermocouple Input		Type K, 0 to 1600°F (-18 to 871°C) (OS532, OS533, OS534 only)
Input Connection		SMP Connector
Thermocouple Display Accuracy @ 75°F (24°C) Ambient Temperature		±5°F (±3°C)
Thermocouple Display Response Time		2 seconds
Operating Ambient Temperature:		32°F to 122°F (0°C to 50°C)
Operating Relative Humidity:		95% or less without condensation
Display:		Backlit LCD dual display
Keypad:		4 position, tactile feed-back membrane switch

## 7 Specifications

---

Average Temperature Accuracy Time Period (under continuous operation):	11½ days										
Emissivity:	0.10 to 1.00 in 0.01 increments, set via keypad										
Calculated Temperature Values:	Maximum (MAX), Minimum (MIN), Average (AVG), Differential (dIF), Thermocouple (TC)										
Ambient Target Temperature Compensation:	Set and enabled via keypad (OS533, OS534, OS523, OS524)										
RS232 Output (for personal computers and serial printers):	Standard on OS533, OS534, OS523, OS524 4800 bits per second, 8 bits of data, 1 stop bit, no parity										
RS-232 Cable:	RJ12 to 25 pin D connector, Female										
	<table border="0"> <thead> <tr> <th><u>RJ12 Pin #</u></th> <th><u>25 pin D connector Pin #</u></th> </tr> </thead> <tbody> <tr> <td>3</td> <td>3</td> </tr> <tr> <td>5</td> <td>7</td> </tr> <tr> <td></td> <td>4 &amp; 5 jumpered</td> </tr> <tr> <td></td> <td>6 &amp; 20 jumpered</td> </tr> </tbody> </table>	<u>RJ12 Pin #</u>	<u>25 pin D connector Pin #</u>	3	3	5	7		4 & 5 jumpered		6 & 20 jumpered
<u>RJ12 Pin #</u>	<u>25 pin D connector Pin #</u>										
3	3										
5	7										
	4 & 5 jumpered										
	6 & 20 jumpered										
Analog Cable:	6 feet long; 2-conductor, 22 AWG 3.5mm male plug										
Alarm:	Set and enabled via keypad										
	<table border="0"> <tr> <td>All models:</td> <td>High alarm standard, with audible and visual indication</td> </tr> <tr> <td>OS533, OS534 OS523, OS524:</td> <td>Low alarm standard, with audible and visual indication</td> </tr> </table>	All models:	High alarm standard, with audible and visual indication	OS533, OS534 OS523, OS524:	Low alarm standard, with audible and visual indication						
All models:	High alarm standard, with audible and visual indication										
OS533, OS534 OS523, OS524:	Low alarm standard, with audible and visual indication										
Data Storage:	OS534, OS523 OS524: Up to 100 sets of data points on command. Each set of data consists of the temperature, the Emissivity and the high alarm value.										
Aiming Feature:	"V" groove on top of the thermometer or use Laser Sighting										
Analog Output:	1 mV/°F or 1 mV/°C, set via keypad (0.5 mV/Deg, OS524)										

Analog Output Accuracy:	±2mV reference to temperature display
Power:	4 AA size 1.5 volt batteries (lithium or alkaline)
Battery Types	
Alkaline:	general brand
Lithium:	Eveready Energizer, model number L91
Battery Storage Temperature	-40°C to 50°C (-40°F to 122°F)
ac adapter:	Optional - available in 120 Vac or 220Vac Class 2 Transformer, UL & CSA Listed
(Input voltage):	120Vac or 220Vac at 60 or 50 Hz
(Output voltage):	9Vdc at 200 mA
(Output plug [female]):	Center positive, coax 2.5/5.5/12mm



Low Battery Indicator:	LOBAT icon and intermittent beep
<u>Alkaline</u> Battery Life at 24°C (75°F) ambient temperature	
(Without Laser Sighting):	60 hours (continuous operation)
(With Laser Sighting Dot or Circle):	6 hours (continuous operation)
	(With LCD backlighting and no Laser Sighting): 17 hours (continuous operation)

<u>Lithium</u> Battery Life at 24°C (75°F) ambient temperature	
(Without Laser Sighting):	10 days (continuous operation)
(With Laser Sighting Dot or Circle):	30 hours (continuous operation)
(With LCD backlighting and no Laser Sighting):	3 days (continuous operation)





Tripod Mount:	¼"-20 UNC
Wrist Strap:	Attached to the thermometer case
Soft Carrying Case:	Standard
Dimensions:	8.6" x 6.6" x 2.0" (218.4 x 167.6 x 50.8 mm)
Weight:	1.3 lbs (0.585 kg)

---

**LASER SIGHTING**

---

Wavelength (Color):	630-670 nanometers (red)
Operating Distance:	
Laser Dot	2 to 40 ft.
Laser Circle	2 to 15 ft.
Max. Output Optical Power:	<1 mW at 75°F ambient temperature, Class II Laser Product
European Classification:	Class 2, EN60825-1
Maximum Operating Current:	25mA at 5.5 V
FDA Classification:	Complies with 21 CFR Chapter 1, Subchapter J
Beam Diameter:	5 mm
Beam Divergence:	<2mrad
Laser Configuration	Dot/Circle switchable except for OS53x-CF and OS523-3 models
Operating Temperature:	32°F to 122°F (0°C to 50°C)
Operating Relative Humidity:	95% or less without condensation
Power Switch:	Slide switch, ON - OFF
Power Indicator:	Red LED
Power:	Supplied by the thermometer
Identification Label:	Located on the bottom of the thermometer
Warning & Certification Label:	Located on the left side of the thermometer (for the label layout, refer to the inside back cover)

Key(s)	Key(s) Functions
	<ul style="list-style-type: none"> <li>Selects one of the following Display Modes: E , MAX, MIN, dIF, AVG, TC, HAL, LAL, AMB, PRN or MEM.</li> </ul>
	<ul style="list-style-type: none"> <li>Locks/unlocks the trigger.</li> <li>Enables/disables High Alarm.</li> <li>Enables/disables Target Ambient Temperature Compensation.</li> <li>Enables/disables sending data to the personal computer or serial printer.</li> <li>Stores temperature data on command.</li> <li>Displays previously stored data.</li> </ul>
	<ul style="list-style-type: none"> <li>Increments the data or value displayed.</li> <li>Turns on or off the backlighting (only in MAX, MIN, dIF, TC or AVG Display Modes).</li> </ul>
	<ul style="list-style-type: none"> <li>Decrements the data or value displayed.</li> <li>Changes the unit of measure from °F to °C or vice versa (only in MAX, MIN, dIF, TC or AVG Display Modes).</li> </ul>

Press and hold down the  key & then press the

 key

 and  keys

- Allows you to go to the Diagnostic Routine.
- Allows you to erase all 100 stored temperature data from the memory.

**Notes**

---

---

---

---

---

---

---

---

---

---

---

---

---

---

---

---

---

---

---

---

---

---

---

---

---

### Thermal Radiation

Heat is transferred from all objects via radiation in the form of electromagnetic waves or by conduction or convection. All objects having a temperature greater than absolute zero (-459°F, -273°C, 0 K) radiate energy. The thermal energy radiated by an object increases as the object gets hotter. Measurement of this thermal energy allows an infrared thermometer to calculate the object's temperature if the emissivity (blackness) is known. Generally, it is convenient to measure the amount of radiated energy in the infrared part of an object's radiation spectrum.

Figure A-1 shows a block diagram of an infrared radiation thermometer. Energy from the object is focused by the lens onto the detector. As the detector heats up, it sends out an electrical signal, which in turn is amplified and sent to the circuitry of the thermometer. The thermometer software then calculates the temperature of the object.

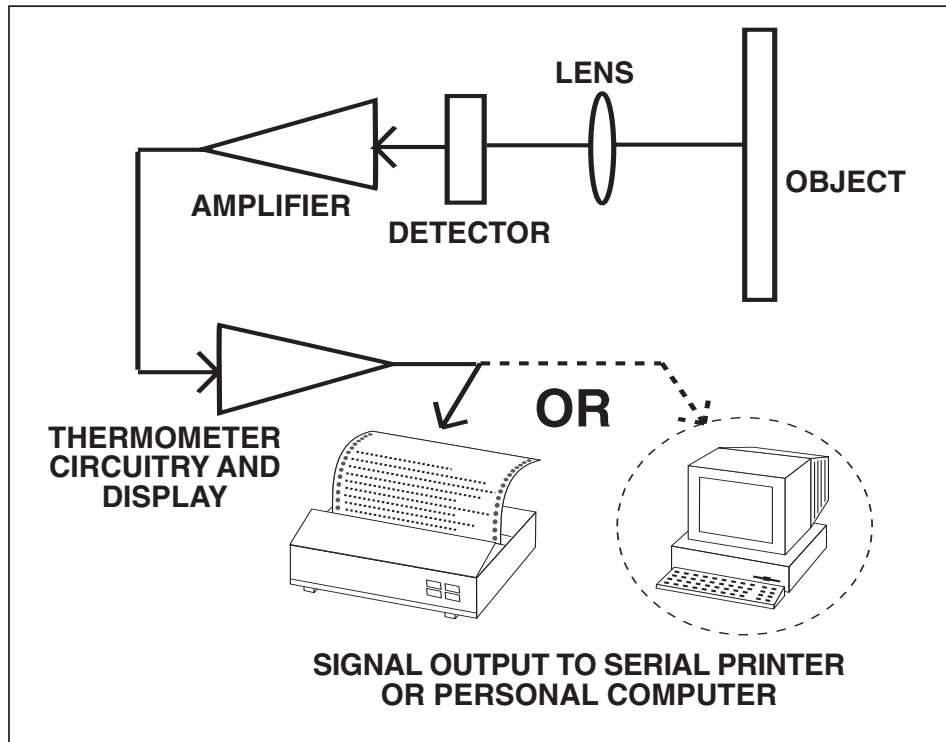

Figure A-1. Infrared Thermometer Block Diagram



## Blackbody

When thermal radiation falls on an object, part of the energy is transmitted through the object, part is reflected and part is absorbed. A blackbody is defined as an ideal object that absorbs all the radiation incident upon it. The best example of a real object that acts like a blackbody is a small hole drilled deep into a large opaque cavity. Thermal radiation entering the cavity is internally reflected and has little chance of escaping the cavity before it is fully absorbed.

Emissivity is defined as the ratio of energy radiated by an object to that of the energy radiated by a blackbody. By definition, the emissivity of a blackbody is 1. Most objects are considered *gray objects* with an emissivity between 0 and 1. Various emissivities for common materials are shown in Appendix B.

## Spectral Distribution

Objects radiate energy at different wavelengths, but not with constant intensity at each wavelength. Figure A-2 shows the energy radiated by a blackbody at various temperatures as a function of wavelength. As a body is heated, the intensity of the radiated energy increases and the peak of the curve shifts towards the shorter wavelength end of the spectrum. The total area under a spectral distribution curve is proportional to the total energy radiated by the blackbody at a given temperature.

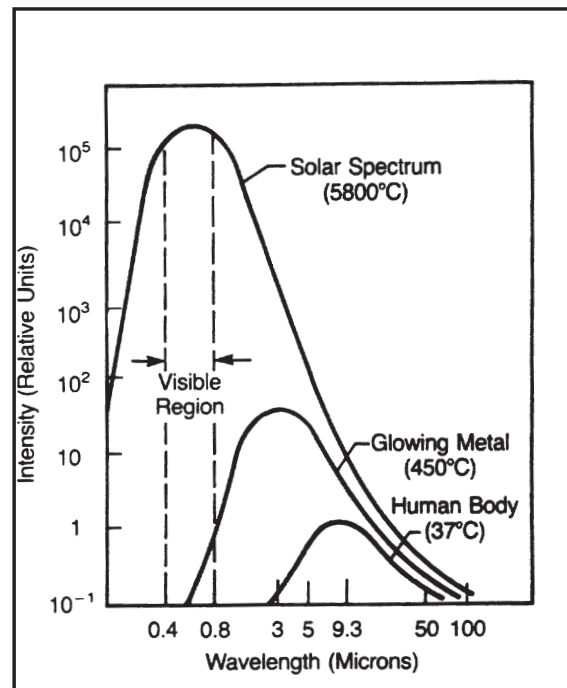

Relative emission from a blackbody versus wavelength. The area under the curve corresponds to the total energy, and is proportional to the absolute temperature to the 4th power. The peak of the spectral distribution curve shifts to shorter wavelengths as the temperature increases.

Figure A-2. Blackbody Spectral Distribution

Wien's Displacement Law describes the exact mathematical relationship between the temperature of a blackbody and the wavelength of the maximum intensity radiation.

$$\lambda_m = \frac{2.898}{T}$$

where  $\lambda_m$  = wavelength measured in microns  
T = temperature in Kelvin

## Calculating Temperature

The net thermal power radiated by an object has been shown to depend on its emissivity, its temperature and that of the ambient temperature around the object. A very useful equation known today as the Stefan-Boltzmann Law has been shown both theoretically and empirically to describe the relationship.

$$I = \epsilon\sigma(T^4 - T_a^4)$$

I = thermal power in watts/meter<sup>2</sup>

$\epsilon$  = Emissivity

$\sigma$  =  $5.6703 \times 10^{-8}$  watts/meter<sup>2</sup> x K<sup>4</sup> (Stefan's constant)

T = temperature of object in Kelvin

$T_a$  = temperature of ambient surroundings in Kelvin

The infrared thermometer uses this equation directly in calculating the temperature of an object. The incident power is measured by the infrared detector. The emissivity of the object is determined by the user. The ambient temperature is measured by a sensor inside the thermometer. With all quantities known, the thermometer uses the Stefan-Boltzmann Law to calculate and output the temperature of the object.

## Optics Field of View

Accurate measurement of temperature via infrared means depends strongly on the size of the object and the distance between the thermometer and the object. All optical devices (e.g. cameras, microscopes, infrared thermometers) have an angle of vision, known as a field of view or FOV, within which they see all objects. In particular, the thermometer will measure a fixed proportion of the energy radiated by all objects within its FOV. The user must guarantee that the distance between the thermometer and the object is defined so that only that object fills the FOV of the instrument.

Referring to Figure A-3, Objects "X" and "Y" are within the FOV of the thermometer. The measured temperature would fall somewhere between the actual temperatures of the two objects. In order to measure the temperature of Object "X" accurately, Object "Y" would need to be removed. In order to measure the temperature of Object "Y" accurately, the user would need to move closer to Object "Y" until it completely filled the FOV of the thermometer. Alternatively, the user could measure the temperature of Object "Y" with a thermometer with a smaller FOV.

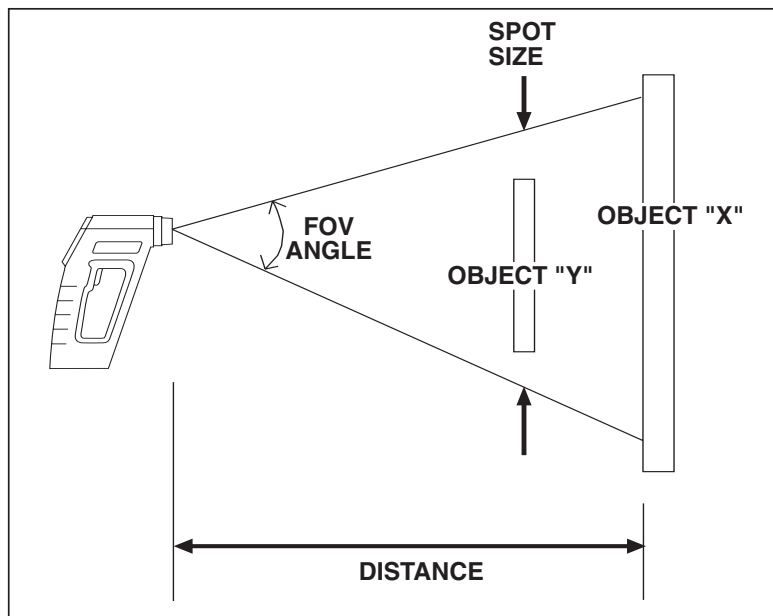

Figure A-3. Field of View of a Thermometer

The distance-to-spot size ratio ( $\%$ ) defines the field of view (FOV). Thus, a  $\%$  = 10 gives you approximately a 1 foot spot size at a distance of 10 feet. For accurate spot size values, refer to the Field of View diagrams shown in Figures 2-4 through 2-6.

Table B-1 provides *guidelines for estimating the emissivity* of various common materials. Actual emissivity, especially of metals, can vary greatly depending upon surface finish, oxidation, or the presence of contaminants. Also, emissivity or infrared radiation for some materials varies with wavelength and temperature. To determine the *exact emissivities* for most applications, follow the procedures in Appendix C.

**Table B-1. Emissivity Table**

**METALS**

<b>Material</b>	<b>Emissivity (<math>\epsilon</math>)</b>
<u>Aluminum</u> – pure highly polished plate . . . . .	0.04 – 0.06
<u>Aluminum</u> – heavily oxidized . . . . .	0.20 – 0.31
<u>Aluminum</u> – commercial sheet . . . . .	0.09
<u>Brass</u> – dull plate . . . . .	0.22
<u>Brass</u> – highly polished, 73.2% Cu, 26.7% Zn . . . . .	0.03
<u>Chromium</u> – polished . . . . .	0.08 – 0.36
<u>Copper</u> – polished . . . . .	0.05
<u>Copper</u> – heated at 1110°F (600°C) . . . . .	0.57
<u>Gold</u> – pure, highly polished or liquid . . . . .	0.02 – 0.04
<u>Iron and steel (excluding stainless)</u> – polished iron . . . . .	0.14 – 0.38
<u>Iron and steel (excluding stainless)</u> – polished cast iron . . . . .	0.21
<u>Iron and steel (excluding stainless)</u> – polished wrought iron . . . . .	0.28
<u>Iron and steel (excluding stainless)</u> – oxidized dull wrought iron . . . . .	0.94
<u>Iron and steel (excluding stainless)</u> – rusted iron plate . . . . .	0.69
<u>Iron and steel (excluding stainless)</u> – polished steel . . . . .	0.07
<u>Iron and steel (excluding stainless)</u> – polished steel oxidized at 1110°F (600°C) . . . . .	0.79
<u>Iron and steel (excluding stainless)</u> – rolled sheet steel . . . . .	0.66
<u>Iron and steel (excluding stainless)</u> – rough steel plate . . . . .	0.94 – 0.97
<u>Lead</u> – gray and oxidized . . . . .	0.28
<u>Mercury</u> . . . . .	0.09 – 0.12
<u>Molybdenum filament</u> . . . . .	0.10 – 0.20
<u>Nickel</u> – polished . . . . .	0.07
<u>Nickel</u> – oxidized at 1200°F – 2290°F . . . . .	0.59 – 0.86
<u>Platinum</u> – pure polished plate . . . . .	0.05 – 0.10
<u>Platinum</u> – wire . . . . .	0.07 – 0.18
<u>Silver</u> – pure and polished . . . . .	0.02 – 0.03
<u>Stainless steel</u> – polished . . . . .	0.07
<u>Stainless steel</u> – Type 301 at 450°F – 1725°F . . . . .	0.54 – 0.63
<u>Tin</u> – bright . . . . .	0.06
<u>Tungsten</u> – filament . . . . .	0.39
<u>Zinc</u> – polished commercial pure . . . . .	0.05
<u>Zinc</u> – galvanized sheet . . . . .	0.23

<b>Material</b>	<b>Emissivity (<math>\epsilon</math>)</b>
<u>Asbestos Board</u> . . . . .	0.96
<u>Asphalt, tar, pitch</u> . . . . .	0.95 – 1.00
<u>Brick</u> – red and rough . . . . .	0.93
<u>Brick</u> – fireclay . . . . .	0.75
<u>Carbon</u> – filament . . . . .	0.53
<u>Carbon</u> – lampblack - rough deposit . . . . .	0.78 – 0.84
<u>Glass</u> - Pyrex, lead, soda . . . . .	0.85 – 0.95
<u>Marble</u> – polished light gray . . . . .	0.93
<u>Paints, lacquers, and varnishes</u> – Black matte shellac . . . . .	0.91
<u>Paints, lacquers, and varnishes</u> – aluminum paints . . . . .	0.27 – 0.67
<u>Paints, lacquers, and varnishes</u> – flat black lacquer . . . . .	0.96 – 0.98
<u>Paints, lacquers, and varnishes</u> – white enamel varnish . . . . .	0.91
<u>Porcelain</u> – glazed . . . . .	0.92
<u>Quartz</u> – opaque . . . . .	0.68 – 0.92
<u>Roofing Paper</u> . . . . .	0.91
<u>Tape</u> – Masking . . . . .	0.95
<u>Water</u> . . . . .	0.95 – 0.96
<u>Wood</u> – planed oak . . . . .	0.90



In Appendix A, we showed how emissivity is an important parameter in calculating the temperature of an object via infrared means. In this section we discuss how to determine a specific emissivity value. If you know the material of the object, use Table B-1 in Appendix B to look up its approximate emissivity. Most organic materials such as plastics, cloth, or wood have an emissivity of about 0.95. For this reason, we use 0.95 as the default emissivity setting in the OS530 Series Thermometer.

For objects of unknown material or for very precise measurements, use one of the following methods to determine a specific emissivity value.

### Method 1

1. Measure and record the temperature of the object using a contact temperature probe such as a thermocouple or RTD.
2. Aim the thermometer at the object.
3. Adjust the emissivity until the temperature reading of the thermometer equals the temperature measured in Step 1.

### Method 2

1. Heat the object (or at least a sample of the object material) on top of a heating plate to a known temperature. Make sure the thermometer and the air surrounding the heating plate are at the same temperature.
2. Measure the temperature of the object material with the thermometer. Make sure that the object fills the FOV of the thermometer.
3. Adjust the emissivity until the temperature reading of the thermometer equals the known temperature of Step 1.

### Method 3

1. Use this method to measure objects at temperatures below 500°F (260°C).
2. Place a large piece of masking tape on the object (or at least a sample of the object material). Allow time for the masking tape to reach the object temperature.
3. Set the emissivity of the thermometer to 0.95. Use the thermometer to measure and record the temperature of the masking tape - Area 'A' in Figure C-1. Make sure that the area of the object covered with masking tape fills the FOV of the thermometer.

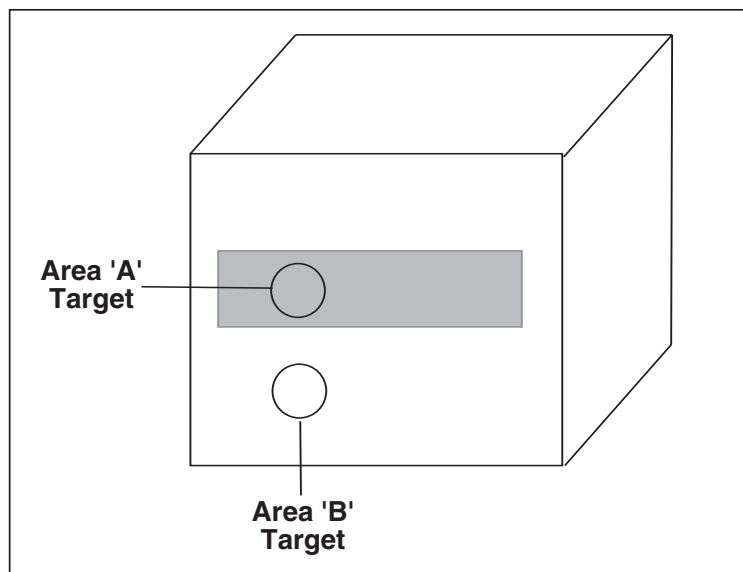

Figure C-1. Determining Emissivity

4. Aim the thermometer at Area 'B' as shown in Figure C-1. Make sure that Area 'B' is as close as possible to Area 'A'.
5. Adjust the emissivity of the thermometer until the temperature reading equals the temperature found in Step 3.

### Method 4

1. Paint a sample of the object material with flat black lacquer paint.
2. Set the emissivity to 0.97 and measure and record the temperature of the painted portion of the sample material - Area 'A' in Figure C-1. Make sure that the painted area of object material fills the FOV of the thermometer.
3. Aim the thermometer at another spot on the target - Area 'B' in Figure C-1.
4. Adjust the emissivity of the thermometer until the temperature reading equals the temperature found in Step 2.

### Method 5

1. Use this method where practical to measure objects at temperatures above 500°F (260°C).
2. Drill a 1.5" (35 mm) diameter hole in a sample of the object material to a depth of 5" (127 mm). This hole closely resembles a blackbody (refer to Appendix A).

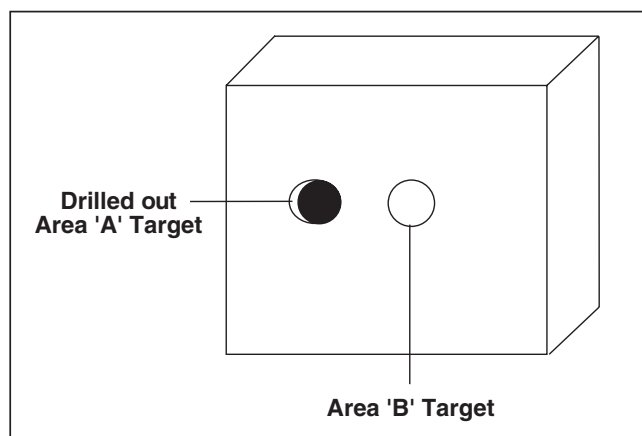

Figure C-2. Determining Emissivity with a Drilled Hole

3. Set the emissivity to 0.97 and measure and record the temperature of the hole in the sample material - Area 'A' in Figure C-2. Make sure that the hole fills the FOV of the thermometer.
4. Aim the thermometer at another spot on the target as close as possible to Area 'A' (Area 'B' in Figure C-2).
5. Adjust the emissivity of the thermometer until the temperature reading equals the temperature found in Step 3.





# Appendix: Determining an Unknown Emissivity

---

<b>Notes</b>
--------------

---

---

---

---

---

---

---

---

---

---

---

---

---

---

---

---

---

---

---

---

---

---

---

---

---

---

---

**A**

- ac Adapter Input Jack ..... 1-6
- Active Operation ..... 2-8
- Aiming Sight "V Groove" ..... 1-4
- Alarms ..... 2-14, 2-15
- Alkaline Batteries ..... 2-1, 4-1, 6-3
- Ambient Target Temperature  
  Compensation ..... 2-16
- Analog Output Jack ..... 1-6

**B**

- Backlighting Icon ..... 1-5
- Battery(s):
  - Compartment ..... 1-4, 2-1
  - Installing AA size ..... 2-1
  - Life of ..... 6-3
- Blackbody ..... A-2, C-3
- Beeping Sound     2-14, 2-23, 4-1,  
                          5-2, 6-3

**C**

- Carrying Case ..... 1-2
- Chart Recorder Hookup ..... 2-7
- Computer:
  - Parameters:
    - Speed, Data, Parity,  
  Stop Bit ..... 2-17, 2-27
  - Personal, Hookup ..... 2-19
  - Program (IR\_TEMPSOFT) .....  
                                  2-19, 2-26

**D**

- Diagnostic Program ..... 5-2
- Differential Measurement ..... 2-6
- Display
  - Icons:
    - ATC ..... 1-5
    - Backlighting ..... 1-5
    - HAL ..... 1-5
    - LAL ..... 1-5
    - LCK ..... 1-5
    - LOBAT ..... 1-5
    - PRN ..... 1-5
  - Modes:
    - AMB ..... 1-5
    - AVG ..... 1-5
    - dIF ..... 1-5
    - E ..... 1-5
    - HAL ..... 1-5
    - LAL ..... 1-5
    - MAX ..... 1-5
    - MEM ..... 1-5
    - MIN ..... 1-5
    - PRN ..... 1-5
  - Problems ..... 5-1

**E**

- Emissivities:
  - Adjusting ..... 2-11
  - Definition ..... A-2
  - Figuring out Unknown ..... C-1
  - Values ..... B-1
- Erasing Temperature Data ... 2-24
- Error Codes ..... 5-2, 5-3

**F**

- Field of View:
  - Diagrams ..... 2-3, 2-4
  - Positions ..... 2-2
- Fixed Point Monitoring over Time Measurement ..... 2-7

**G**

- Gray Bodies (Objects) ..... A-2

**H**

- High Alarm Value, setting ... 2-14

**I**

- Icons:
  - ATC ..... 1-5
  - Backlighting ..... 1-5
  - HAL ..... 1-5
  - LAL ..... 1-5
  - LCK ..... 1-5
  - LOBAT ..... 1-5
  - PRN ..... 1-5
- Installing
  - AA Batteries ..... 2-1
  - Laser Sight Module ..... 3-3, 3-4

**J**

- Jacks
  - ac Adapter Input ..... 1-6
  - Analog Output ..... 1-6
  - RS-232 Phone ..... 1-6

**K**

- Keypad, 4-position ..... 1-4
- Keys:
  - ▼ & °F-°C ..... 1-4, 1-5
  - FUNC (Function) ..... 1-4, 1-5
  - LOCK (Lock) ..... 1-4, 1-5
  - ▲ & ○-● ..... 1-4, 1-5
- Key Strokes ..... 7-1

**L**

- Label Layout:
  - Danger & Certification ..... Inside Back Cover
- Laser Sight Module:
  - Laser Circle ..... 3-3
  - Laser Dot ..... 3-3
  - Installing onto
    - Thermometer ..... 3-4
  - Line of Sight ..... 3-4
  - Power Button ..... 2-2, 3-2
  - Problems ..... 5-1 - 5-4
  - Power Indicator LED.... 2-2, 3-2
  - Removing from
    - Thermometer ..... 3-4, 3-5
  - Warnings and Cautions ..... 3-1
- LCD, Backlit ..... 1-4
- Lens Cleaning ..... 4-2
- Lines of Sight of the Module and Thermometer ..... 3-4
- Lithium Batteries ..... 2-1, 4-1, 6-3
- Lock Function ..... 2-11
- Low Alarm Value, setting ... 2-15

**M**

- Main Display ..... 1-4
- Modes:
  - Real Time ..... 2-8
  - Recall ..... 2-23, 2-25
- Moving Surface Scan ..... 2-7

**O**

- Optics ..... A-4

**P**

- Parameters, reviewing ..... 2-27
- PAS Code ..... 5-2
- Passive Operation ..... 2-25
- Personal Computer
  - Hookup ..... 2-19
- Power Contacts:
  - Cleaning ..... 4-2
  - On Laser Sight Module .. 1-4, 4-2
- Power Indicator LED ..... 2-2, 3-2
- Printer, Serial, Hookup ..... 2-17

**R**

- Real Time Mode Block
  - Diagram ..... 2-8
- Recall Mode Block Diagram ... 2-26
- Replacing AA Batteries ..... 4-1
- RS-232 Phone Jack ..... 1-6
- Rubber Boot:
  - Display ..... 1-4
  - IR Lens ..... 1-4

**S**

- Serial Printer Hookup ..... 2-18
- Sleep Mode ..... 2-5, 2-8,  
.....2-12, 2-28, 5-1
- Spectral Distribution ..... A-2
- Spot Measurement ..... 2-6
- Static Surface Scan ..... 2-6
- Stefan-Boltzmann Law ..... A-3
- Storing Temperature Data .... 2-23

**T**

- Temperature Data:
  - Erasing .....2-24
  - Storing ..... 2-23
- Thermal Radiation ..... A-1
- Thermometer:
  - Front View .....1-4
  - Rear View .....1-6
- Tripod Thread Mount ..... 1-4, 1-6

**V**

- “V” Groove Aiming Sight ..... 1-4

**W**

- Wein’s Displacement Law .... A-3
- Wrist Strap ..... 1-4



## WARRANTY/DISCLAIMER

OMEGA ENGINEERING, INC. warrants this unit to be free of defects in materials and workmanship for a period of **25 months** from date of purchase on the base unit and **13 months** from date of purchase on Laser Sight Module. OMEGA WARRANTY adds an additional one (1) month grace period to the normal **product warranty** to cover handling and shipping time. This ensures that OMEGA's customers receive maximum coverage on each product.

If the unit should malfunction, it must be returned to the factory for evaluation. OMEGA's Customer Service Department will issue an Authorized Return (AR) number immediately upon phone or written request. Upon examination by OMEGA, if the unit is found to be defective it will be repaired or replaced at no charge. OMEGA's WARRANTY does not apply to defects resulting from any action of the purchaser, including but not limited to mishandling, improper interfacing, operation outside of design limits, improper repair, or unauthorized modification. This WARRANTY is VOID if the unit shows evidence of having been tampered with or shows evidence of being damaged as a result of excessive corrosion; or current, heat, moisture or vibration; improper specification; misapplication; misuse or other operating conditions outside of OMEGA's control. Components in which wear are not warranted, include but are not limited to contact points, fuses, and triacs.

**OMEGA is pleased to offer suggestions on the use of its various products. However, OMEGA neither assumes responsibility for any omissions or errors nor assumes liability for any damages that result from the use of its products in accordance with information provided by OMEGA, either verbal or written. OMEGA warrants only that the parts manufactured by the company will be as specified and free of defects. OMEGA MAKES NO OTHER WARRANTIES OR REPRESENTATIONS OF ANY KIND WHATSOEVER, EXPRESSED OR IMPLIED, EXCEPT THAT OF TITLE, AND ALL IMPLIED WARRANTIES INCLUDING ANY WARRANTY OF MERCHANTABILITY AND FITNESS FOR A PARTICULAR PURPOSE ARE HEREBY DISCLAIMED. LIMITATION OF LIABILITY: The remedies of purchaser set forth herein are exclusive and the total liability of OMEGA with respect to this order, whether based on contract, warranty, negligence, indemnification, strict liability or otherwise, shall not exceed the purchase price of the component upon which liability is based. In no event shall OMEGA be liable for consequential, incidental or special damages.**

CONDITIONS: Equipment sold by OMEGA is not intended to be used, nor shall it be used: (1) as a "Basic Component" under 10 CFR 21 (NRC), used in or with any nuclear installation or activity; or (2) in medical applications or used on humans. Should any Product(s) be used in or with any nuclear installation or activity, medical application, used on humans, or misused in any way, OMEGA assumes no responsibility as set forth in our basic WARRANTY/DISCLAIMER language, and additionally, purchaser will indemnify OMEGA and hold OMEGA harmless from any liability or damage whatsoever arising out of the use of the Product(s) in such a manner.

## RETURN REQUESTS / INQUIRIES

Direct all warranty and repair requests/inquiries to the OMEGA Customer Service Department. BEFORE RETURNING ANY PRODUCT(S) TO OMEGA, PURCHASER MUST OBTAIN AN AUTHORIZED RETURN (AR) NUMBER FROM OMEGA'S CUSTOMER SERVICE DEPARTMENT (IN ORDER TO AVOID PROCESSING DELAYS). The assigned AR number should then be marked on the outside of the return package and on any correspondence.

The purchaser is responsible for shipping charges, freight, insurance and proper packaging to prevent breakage in transit.

FOR **WARRANTY** RETURNS, please have the following information available BEFORE contacting OMEGA:

1. P.O. number under which the product was PURCHASED,
2. Model and serial number of the product under warranty, and
3. Repair instructions and/or specific problems relative to the product.

FOR **NON-WARRANTY** REPAIRS, consult OMEGA for current repair charges. Have the following information available BEFORE contacting OMEGA:

1. P.O. number to cover the COST of the repair,
2. Model and serial number of product, and
3. Repair instructions and/or specific problems relative to the product.

**PATENT NOTICE:** U.S. PAT. D357,194, B1 5,368,392, 5,524,984, 5,727,880, 5,465,838 5,823,678, 5,823,679, 6,267,500B1, 6,123,453, 6,341,891B1/Canada 75811 (D) OMEGA ENGINEERING, INC., 2,116,055, 2,114,806/Czech Republic 25372/France 0378411 to 0378446, 2,767,921, 2 773 213 B1/Germany M 94 06 478.4, G 94 22 197.9, G 94 22 203.7/Italy RM940000913/Japan 988,378/Netherlands 1007752, 25009-00/Spain mod. ut. 133292/Slovak Republic 24565/U.K. Registered 2041153, 9726133.3, EPO 0 644408, EP 1 085 307 A1 Other U.S. and International Patents Pending.

OMEGA's policy is to make running changes, not model changes, whenever an improvement is possible. This affords our customers the latest in technology and engineering.

OMEGA is a registered trademark of OMEGA ENGINEERING, INC.

© Copyright 2005 OMEGA ENGINEERING, INC. All rights reserved. This document may not be copied, photocopied, reproduced, translated, or reduced to any electronic medium or machine-readable form, in whole or in part, without prior written consent of OMEGA ENGINEERING, INC.

### Warning and Certification Label

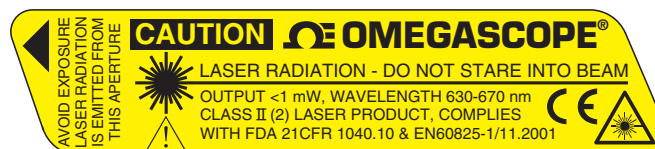

Label Location - refer to Section 3.2    Warnings and Cautions - refer to Section 3.1

# Where Do I Find Everything I Need for Process Measurement and Control? **OMEGA...Of Course!** *Shop online at [omega.com](http://omega.com)*

## **TEMPERATURE**

- ☑ Thermocouple, RTD & Thermistor Probes, Connectors, Panels & Assemblies
- ☑ Wire: Thermocouple, RTD & Thermistor
- ☑ Calibrators & Ice Point References
- ☑ Recorders, Controllers & Process Monitors
- ☑ Infrared Pyrometers

## **PRESSURE, STRAIN AND FORCE**

- ☑ Transducers & Strain Gages
- ☑ Load Cells & Pressure Gages
- ☑ Displacement Transducers
- ☑ Instrumentation & Accessories

## **FLOW/LEVEL**

- ☑ Rotameters, Gas Mass Flowmeters & Flow Computers
- ☑ Air Velocity Indicators
- ☑ Turbine/Paddlewheel Systems
- ☑ Totalizers & Batch Controllers

## **pH/CONDUCTIVITY**

- ☑ pH Electrodes, Testers & Accessories
- ☑ Benchtop/Laboratory Meters
- ☑ Controllers, Calibrators, Simulators & Pumps
- ☑ Industrial pH & Conductivity Equipment

## **DATA ACQUISITION**

- ☑ Data Acquisition & Engineering Software
- ☑ Communications-Based Acquisition Systems
- ☑ Plug-in Cards for Apple, IBM & Compatibles
- ☑ Datalogging Systems
- ☑ Recorders, Printers & Plotters

## **HEATERS**

- ☑ Heating Cable
- ☑ Cartridge & Strip Heaters
- ☑ Immersion & Band Heaters
- ☑ Flexible Heaters
- ☑ Laboratory Heaters

## **ENVIRONMENTAL MONITORING AND CONTROL**

- ☑ Metering & Control Instrumentation
- ☑ Refractometers
- ☑ Pumps & Tubing
- ☑ Air, Soil & Water Monitors
- ☑ Industrial Water & Wastewater Treatment
- ☑ pH, Conductivity & Dissolved Oxygen Instruments

M2891/0903