

**FLUKE®**

**T3**  
Tester

## Calibration Manual

PN 1599206  
February 2001 Rev. 2 4/06  
© 2001-2006 Fluke Corporation, All rights reserved. Printed in USA  
All product names are trademarks of their respective companies.

## LIMITED WARRANTY AND LIMITATION OF LIABILITY

Each Fluke product is warranted to be free from defects in material and workmanship under normal use and service. The warranty period is one year and begins on the date of shipment. Parts, product repairs, and services are warranted for 90 days. This warranty extends only to the original buyer or end-user customer of a Fluke authorized reseller, and does not apply to fuses, disposable batteries, or to any product which, in Fluke's opinion, has been misused, altered, neglected, contaminated, or damaged by accident or abnormal conditions of operation or handling. Fluke warrants that software will operate substantially in accordance with its functional specifications for 90 days and that it has been properly recorded on non-defective media. Fluke does not warrant that software will be error free or operate without interruption.

Fluke authorized resellers shall extend this warranty on new and unused products to end-user customers only but have no authority to extend a greater or different warranty on behalf of Fluke. Warranty support is available only if product is purchased through a Fluke authorized sales outlet or Buyer has paid the applicable international price. Fluke reserves the right to invoice Buyer for importation costs of repair/replacement parts when product purchased in one country is submitted for repair in another country.

Fluke's warranty obligation is limited, at Fluke's option, to refund of the purchase price, free of charge repair, or replacement of a defective product which is returned to a Fluke authorized service center within the warranty period.

To obtain warranty service, contact your nearest Fluke authorized service center to obtain return authorization information, then send the product to that service center, with a description of the difficulty, postage and insurance prepaid (FOB Destination). Fluke assumes no risk for damage in transit. Following warranty repair, the product will be returned to Buyer, transportation prepaid (FOB Destination). If Fluke determines that failure was caused by neglect, misuse, contamination, alteration, accident, or abnormal condition of operation or handling, including overvoltage failures caused by use outside the product's specified rating, or normal wear and tear of mechanical components, Fluke will provide an estimate of repair costs and obtain authorization before commencing the work. Following repair, the product will be returned to the Buyer transportation prepaid and the Buyer will be billed for the repair and return transportation charges (FOB Shipping Point).

THIS WARRANTY IS BUYER'S SOLE AND EXCLUSIVE REMEDY AND IS IN LIEU OF ALL OTHER WARRANTIES, EXPRESS OR IMPLIED, INCLUDING BUT NOT LIMITED TO ANY IMPLIED WARRANTY OF MERCHANTABILITY OR FITNESS FOR A PARTICULAR PURPOSE. FLUKE SHALL NOT BE LIABLE FOR ANY SPECIAL, INDIRECT, INCIDENTAL, OR CONSEQUENTIAL DAMAGES OR LOSSES, INCLUDING LOSS OF DATA, ARISING FROM ANY CAUSE OR THEORY.

Since some countries or states do not allow limitation of the term of an implied warranty, or exclusion or limitation of incidental or consequential damages, the limitations and exclusions of this warranty may not apply to every buyer. If any provision of this Warranty is held invalid or unenforceable by a court or other decision-maker of competent jurisdiction, such holding will not affect the validity or enforceability of any other provision.

Fluke Corporation  
P.O. Box 9090  
Everett, WA 98206-9090  
U.S.A.

Fluke Europe B.V.  
P.O. Box 1186  
5602 BD Eindhoven  
The Netherlands

11/99

# Table of Contents

Title	Page
Introduction.....	1
Definition Symbols Used in this Manual.....	1
Safety Information .....	2
Parts and Service.....	3
Specifications.....	3
Cleaning the Tester .....	4
Required Equipment .....	4
Performance Tests.....	4
Testing the Voltage Function .....	4
Continuity Function Tests .....	5
Calibration Adjustment.....	5
Battery Replacement.....	7
Parts and Accessories.....	8



## ***List of Tables***

<b>Table</b>	<b>Title</b>	<b>Page</b>
1.	Symbols.....	1
2.	DC and AC Voltage Tests.....	4
3.	Replacement Parts and Accessories.....	8

## ***List of Figures***

<b>Figure</b>	<b>Title</b>	<b>Page</b>
1.	Calibration Adjustment Point.....	6
2.	Replacing the Batteries.....	7



# T3

## Introduction















This calibration information sheet provides the following information for the T3 Tester (hereafter referred to as "the tester"):

- Safety information
- Parts and service information
- Specifications
- Cleaning procedure
- Required equipment
- Performance tests
- Calibration adjustment
- Battery replacement procedure
- Parts and accessories list

For operating instructions, refer to the *T3 Tester Instruction Sheet*.

## Definition Symbols Used in this Manual

Table 1. Symbols

	AC (alternating current)		Hazardous Voltage
	DC (direct current)		Double insulated
	Important information		Conforms to European Union Directives
	On light		Beeper
	Earth ground		Underwriters Laboratories Certification
	Conforms to CSA C22.2 No 1010.1	 N10140	Conforms to relevant Australian standards
	Do not dispose of this product as unsorted municipal waste. Contact Fluke or a qualified recycler for disposal.		Verband Deutscher Electroniker. German electronics association.

## **Safety Information**

### **⚠ ⚠ Warning**

To avoid possible electric shock or personal injury, follow these guidelines:

- Do not use the tester if it is damaged. Before you use the tester, inspect the case. Look for cracks or missing plastic. Pay particular attention to the insulation surrounding the connectors.
- Inspect the test leads for damaged insulation or exposed metal. Check the test leads for continuity. Replace damaged test leads before you use the tester.
- Do not use the tester if it operates abnormally. Protection may be impaired. When in doubt, have the tester serviced.
- Do not operate the tester around explosive gas, vapor, or dust.
- Do not apply more than the rated voltage, as marked on the tester, between terminals or between any terminal and earth ground.
- Before use, verify the tester's operation by measuring a known voltage.
- When servicing the tester, use only specified replacement parts.
- If the auto-on light does not come on when the test leads are shorted together, do not use the tester.
- Use caution when working above 30 V ac rms, 42 V peak, or 60 V dc. Such voltages pose a shock hazard.
- When using the probes, keep your fingers behind the finger guards on the probes.
- Connect the common test lead before you connect the live test lead. When you disconnect test leads, disconnect the live test lead first.
- Do not operate the tester with the battery door or portions of the cover removed or loosened.
- Before each use, perform the Battery Test to avoid false readings due to a low battery. Replace the batteries as soon as the tester fails the Battery Test.



## Parts and Service





The tester is warranted to be free from defects in material and workmanship for 1 year, while under normal use. Parts and repairs are warranted for 90 days. For the complete warranty statement, refer to the *T3 Tester Instruction Sheet*.

To order parts, or for warranty service, contact Fluke as follows:

USA: 1-888-99-FLUKE (1-888-993-5853)  
 Canada: 1-800-36-FLUKE (1-800-363-5853)  
 Europe: +31 402-678-200  
 Japan: +81-3-3434-0181  
 Singapore: +65-738-5655  
 Anywhere in the world: +1-425-446-5500

Or, visit Fluke's Web site at [www.fluke.com](http://www.fluke.com).

## Specifications

<b>Display Accuracy</b>	The LED for each range turns on by 95 % of the nominal range value.
<b>Maximum Voltage Between any Terminal and Earth Ground</b>	1000 V dc; 1000 V ac rms (sine wave), Overvoltage Category III; Tester meets requirements for CAT IV 600 V, allowing use on outdoor/direct burial wiring or utility-side measurements.
<b>Input Impedance</b>	~750 kΩ
<b>Temperature</b>	Operating: -10 °C to +50 °C (14 °F to 122 °F) Storage: -30 °C to +60 °C (-22 °F to +140 °F)
<b>Altitude</b>	Operating: 3000 m (9843 ft); Storage: 10,000 m (32808 ft)
<b>Relative Humidity</b>	0 °C to 30 °C (32 °F to 86 °F): 90 %; 30 °C to 40 °C (86 °F to 104 °F): 75 %; 40 °C to 50 °C (104 °F to 122 °F): 45 %
<b>Battery Type and Life</b>	AA (2); 250 hours with NEDA 15F or IEC R6
<b>Shock, Vibration</b>	1 m drop at 15 °C to 35 °C (59 °F to 95 °F). Sinusoidal vibration per MIL-PRF-28800F for a Class 2 instrument (5 Hz to 55 Hz, 3 g maximum)
<b>Safety</b>	<p>This tester complies with IEC 1010-1 to 1000V OVERVOLTAGE Category III, Pollution Degree 2, and with IEC 664-1 to 600 V OVERVOLTAGE Category IV, Pollution Degree 2.*</p> <p>*OVERVOLTAGE (Installation) Categories refer to the level of Impulse Withstand Voltage protection provided at the specified Pollution Degree.</p> <p>Equipment of OVERVOLTAGE CATEGORY III is equipment in fixed installations. Examples include switchgear and polyphase motors.</p> <p>Equipment of OVERVOLTAGE CATEGORY IV is for use at the origin of the installation. Examples include electricity meter and primary over-current protection equipment.</p>
<b>EMC Regulations</b>	EN61326
<b>Certifications</b>	   Listed 950Z,  N10140, 

## Cleaning the Tester

### Warning

**To avoid electrical shock or damage to the tester, never allow water inside the case. To avoid damaging the tester's case, never use solvents on the tester.**

If the tester requires cleaning, wipe it down with a cloth that is lightly dampened with water or a mild detergent. Do not use aromatic hydrocarbons, chlorinated solvents, or methanol-based fluids when wiping down the tester.

## Required Equipment

The following equipment is required for performance tests and calibration adjustments:

- Fluke 5500A Multi-Product Calibrator, or equivalent (DC voltage range: 0 to  $\pm 1020$  V, AC voltage range: 1 mV to 1020V 10 Hz to 500 kHz, sine)
- Small, insulated, Phillips screwdriver
- Fluke 87 Digital Multimeter (maximum DC voltage =  $1000 \text{ V} \pm (0.05\%+1)$ , maximum AC voltage =  $1000 \text{ V} \pm (0.7\%+2)$  )

## Performance Tests

Use the following procedures to verify the tester's performance.

### Testing the Voltage Function

If the tester fails the voltage test, perform the calibration adjustment described under "Calibration Adjustment"; then retest all of the voltage functions. If the tester continues to fail, return it to Fluke for service.

Test the voltage function as follows:

1. Set the calibrator to 199 V dc. Apply this voltage to the tester to verify that the 220 V dc range LED is on.
2. Apply 190 V dc to the tester. Verify that the tester's 220 V dc range LED is off.
3. Apply each nominal voltage and frequency as listed in Table 2. Verify that each corresponding LED turns on.

**Table 2. DC and AC Voltage Tests**

DC Voltages for All Models	AC Voltages for Model T3US (60 Hz)	AC Voltages for Models T3WF/T3WR (50 Hz)	AC Voltages for Model T3CAN (60 Hz)
-6 V dc (verify that -VDC LED is on)	24 V ac	12 V ac	24 V ac
12 V dc	48 V ac	24 V ac	48 V ac
24 V dc	120 V ac	48 V ac	120 V ac
36 V dc	208 V ac	110 V ac	208 V ac
48 V dc	240 V ac	230 V ac	240 V ac
110 V dc	277 V ac	400 V ac	347 V ac
220 V dc	480 V ac	690 V ac	600 V ac



# static awareness



A Message From  
Fluke Corporation

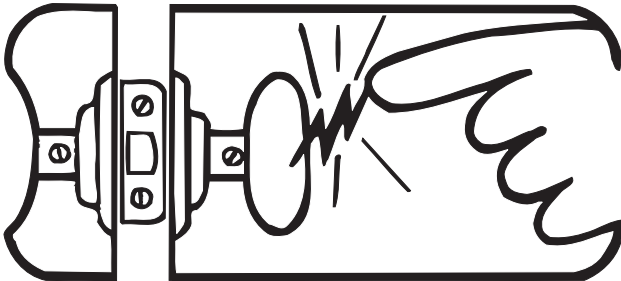

Some semiconductors and custom IC's can be damaged by electrostatic discharge during handling. This notice explains how you can minimize the chances of destroying such devices by:

1. Knowing that there is a problem.
2. Learning the guidelines for handling them.
3. Using the procedures, packaging, and bench techniques that are recommended.

The following practices should be followed to minimize damage to S.S. (static sensitive) devices.

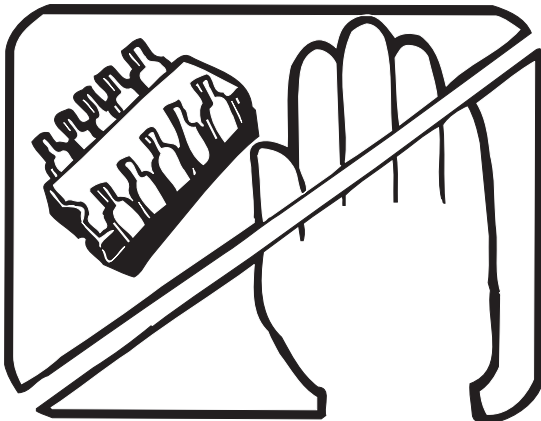

1. MINIMIZE HANDLING

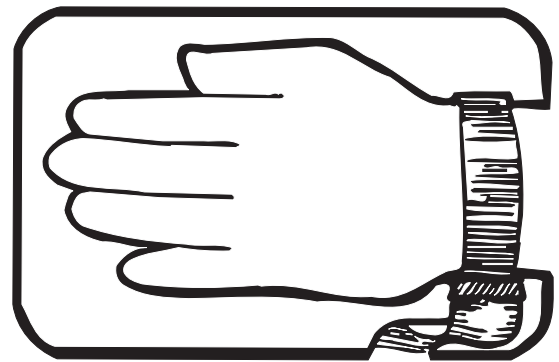

3. DISCHARGE PERSONAL STATIC BEFORE HANDLING DEVICES. USE A HIGH RESISTANCE GROUNDING WRIST STRAP.

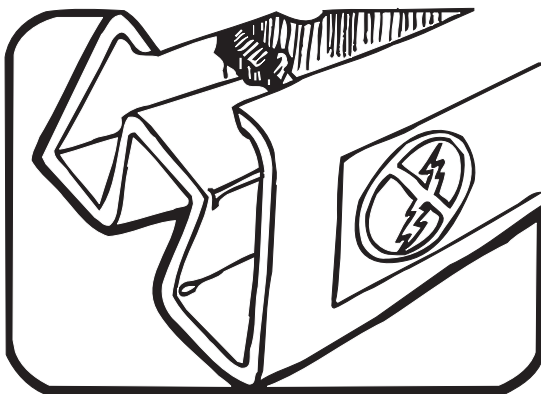

2. KEEP PARTS IN ORIGINAL CONTAINERS UNTIL READY FOR USE.

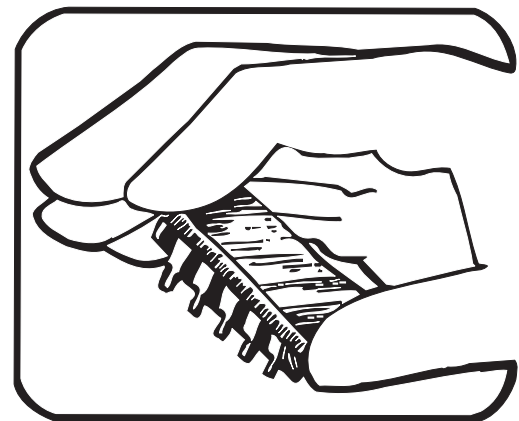

4. HANDLE S.S. DEVICES BY THE BODY.

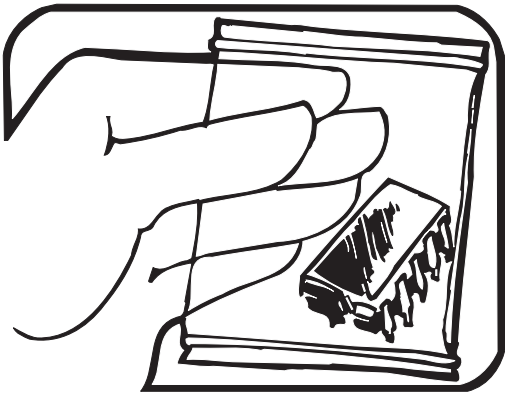

5. USE STATIC SHIELDING CONTAINERS FOR HANDLING AND TRANSPORT.

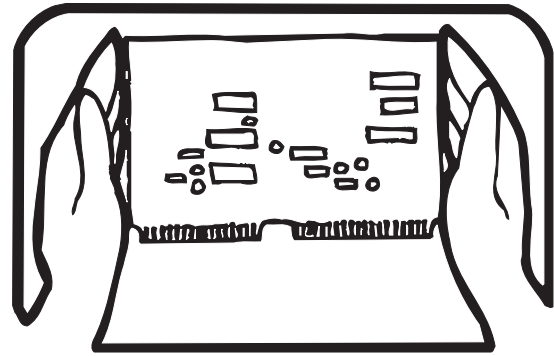

8. WHEN REMOVING PLUG-IN ASSEMBLIES HANDLE ONLY BY NON-CONDUCTIVE EDGES AND NEVER TOUCH OPEN EDGE CONNECTOR EXCEPT AT STATIC-FREE WORK STATION. PLACING SHORTING STRIPS ON EDGE CONNECTOR HELPS PROTECT INSTALLED S.S. DEVICES.

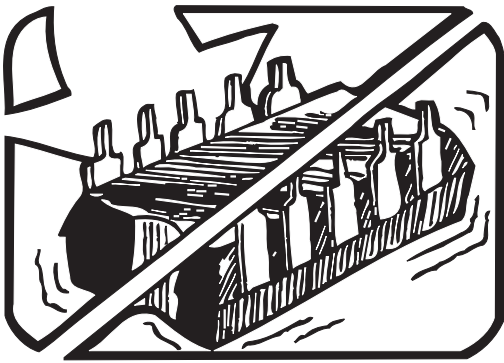

6. DO NOT SLIDE S.S. DEVICES OVER ANY SURFACE.

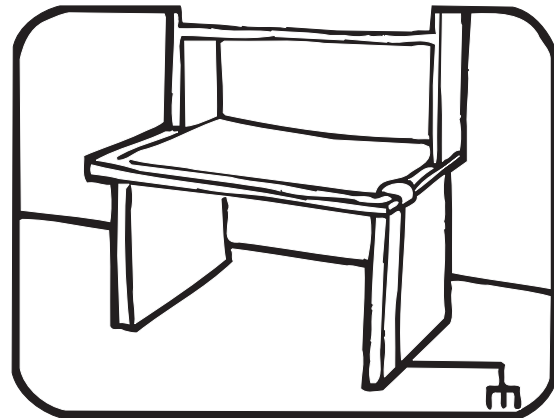

9. HANDLE S.S. DEVICES ONLY AT A STATIC-FREE WORK STATION.

10. ONLY ANTI-STATIC TYPE SOLDER-SUCKERS SHOULD BE USED.

11. ONLY GROUNDED-TIP SOLDERING IRONS SHOULD BE USED.

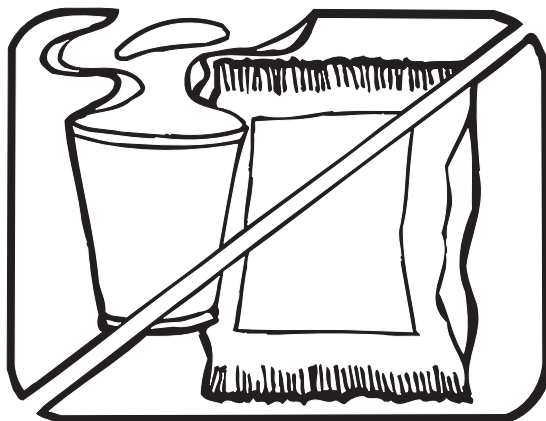

7. AVOID PLASTIC, VINYL AND STYROFOAM® IN WORK AREA.

PORTIONS REPRINTED  
WITH PERMISSION FROM TEKTRONIX INC.  
AND GERNER DYNAMICS, POMONA DIV.

® Dow Chemical

### **Continuity Function Tests**

The following tests verify correct operation of the continuity beeper and LED.

1. Set the calibrator to 20 k $\Omega$ . Apply the 20 k $\Omega$  to the tester and verify that the tester's beeper and continuity LED are ON.
2. Set the calibrator to 200 k $\Omega$ . Apply the 200 k $\Omega$  to the tester and verify that the tester's beeper and continuity LED are OFF.

### **Calibration Adjustment**

If the tester fails a voltage test, perform the following calibration adjustment.

1. Verify that the tester's batteries are good: replace the batteries if touching the leads together does not turn on the continuity LED.
2. Remove the tester's battery door and batteries.
3. Remove the two screws that hold the tester's case together.
4. Remove the top case.
5. Place the tester's batteries in the battery compartment. Temporarily install the battery door to hold the batteries in place during calibration.

#### **Warning**

**It is not necessary to remove the two screws that hold the circuit board in the bottom case; however, if the screws are removed for any reason, they must be secured with Loctite™ or equivalent when reinstalled to prevent them from coming loose.**

6. Turn the tester on by touching the test leads together.
7. Using a calibrated meter, measure the voltage across the voltage divider with the positive lead near R4 and the negative lead at the other end of the divider. Refer to Figure 1.
8. Adjust R4 until the voltage across the divider is as follows:
  - T3USA = 605 - 615 mV
  - T3CAN = 759 - 765 mV
  - T3W = 873 - 883 mV
9. Secure R4 with Loctite™ or equivalent.
10. Reassemble the tester; then perform the voltage tests as given under "Testing the Voltage Functions".

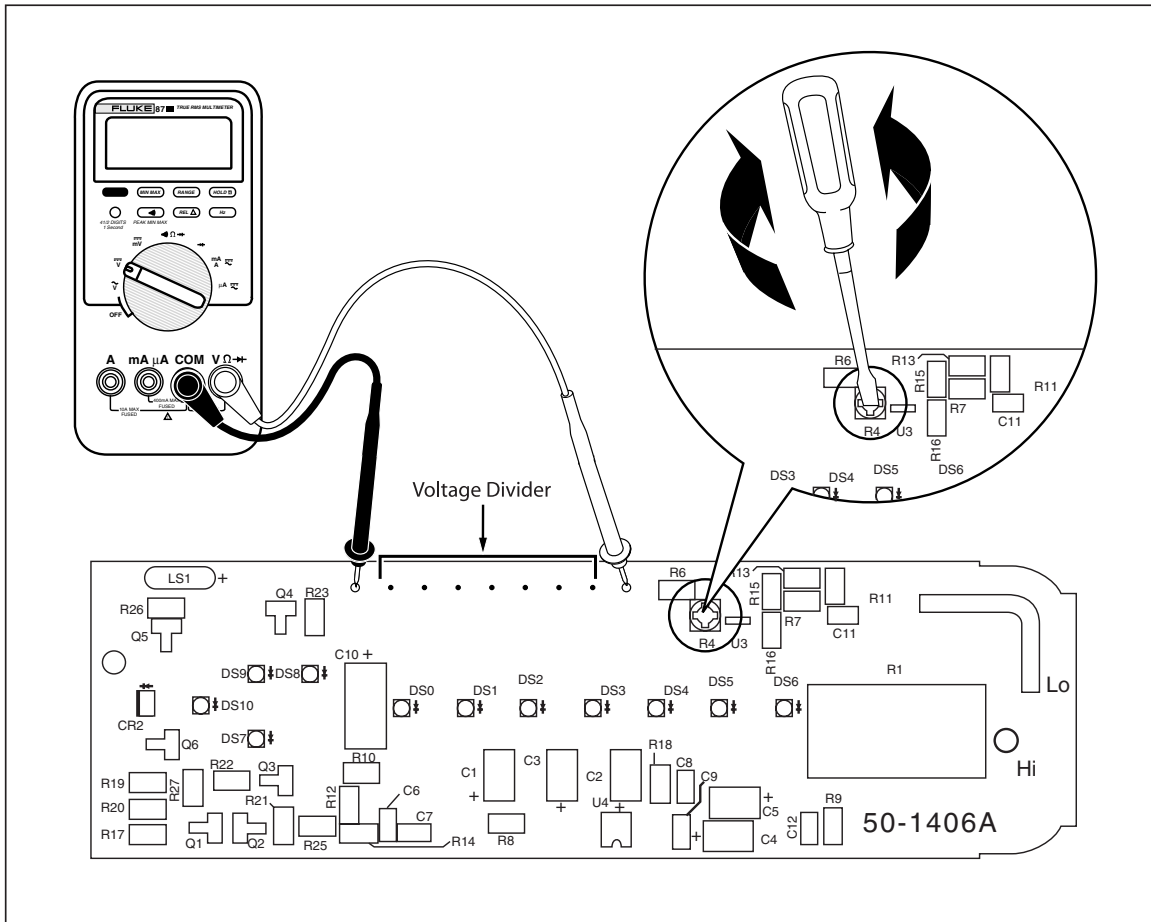
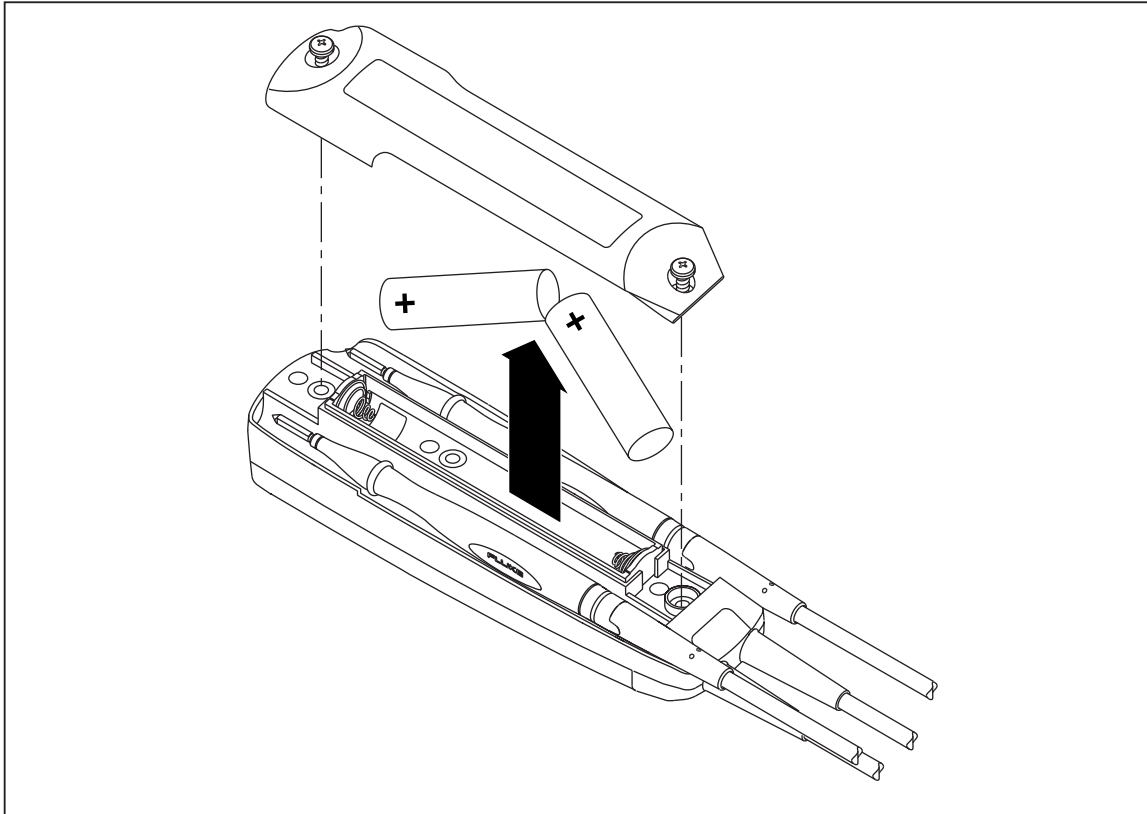

Figure 1. Calibration Adjustment Point

akm1f.eps

## **Battery Replacement**

Replace the batteries when touching the leads together no longer turns on the continuity LED.  
Figure 2 shows how to replace the batteries.





**Figure 2. Replacing the Batteries**

il2f.eps

## Parts and Accessories

Table 3 shows the replacement parts and accessories available from Fluke for the T3 Tester.

**Table 3. Replacement Parts and Accessories**

Description	Fluke Part Number
Test lead assembly, flat blade  <input type="checkbox"/> Replace only with Fluke double-insulated leads.	686733
Test lead assembly, 4 mm round  <input type="checkbox"/> Replace only with Fluke double-insulated leads.	688165
Battery door	1576525
AA battery, 1.5 V, carbon-zinc (2 required) or AA battery, 1.5 V, alkaline (2 required)	650181 376756
<i>T3 Tester Instruction Sheet Packages (Americas)</i> English, French, Spanish	1562069
<i>T3 Tester Instruction Sheet Packages (International)</i> English, French, German, Italian, Finnish, Dutch, Danish, Norwegian, Swedish, Spanish, Portuguese, Korean, Thai, Simplified Chinese, Traditional Chinese	1562078
H5 Belt Holster	Accessory