

TL50Tower Light

Multi-Color General-Purpose or Audible Indicators

For the latest technical information about this product, including specifications, dimensions, and wiring, see www.BannerEngineering.com.



- Rugged, cost-effective and easy-to-install multisegment indicators
- Illuminated segments provide easy-to-see operator guidance and indication of equipment status
- Displays up to 5 colors
- Optional audible function with variable intensity
- Available in black or light gray housing
- Audible models available with standard or sealed audible element
- Compact devices are completely self-contained — no controller needed
- Immune to ambient light, EMI and RFI interference
- Immune to EMI and RFI interference
- 18 to 30V dc or 24V ac operation
- No assembly required

Multi-Color General-Purpose Models



NOTE: More models are listed on the next page.

Model*	# of LED Colors	LED Function†	Connection**	Inputs
TL50RQ	1	Red	4-pin Euro integral QD connector	Bimodal (NPN or PNP)
TL50GRQ	2	Green, Red		
TL50GYRQ	3	Green, Yellow, Red		
TL50BGRQ	4	Blue, Green, Yellow, Red	5-pin Euro integral QD connector	
TL50WBGYRQ	5	White, Blue, Green, Yellow, Red	8-pin Euro integral QD connector	

† The first color listed is the bottom color, going up in successive order. Contact factory for other colors and color combinations.

* Models with black housing are listed. For gray housing, add suffix **C** at the end of model number (cabled models) or before the **Q** (QD models), e.g., **TL50GYRC** or **TL50GYRCQ**.

** Integral QD models only are listed; mating cordset required (see [Quick-Disconnect \(QD\) Cordsets](#) on page 4):

- For 150 mm PVC pigtail with QD, replace **Q** with **QP** in model number (e.g., **TL50GYRQP**).
- For 2 m (6.5') cable, omit suffix **Q** from model number (e.g., **TL50GYR**).



WARNING: Not To Be Used for Personnel Protection

Never use this product as a sensing device for personnel protection. Doing so could lead to serious injury or death. This product does NOT include the self-checking redundant circuitry necessary to allow its use in personnel safety applications. A sensor failure or malfunction can cause either an energized or de-energized sensor output condition.



Multi-Color Audible Models

Model*		# of LED Colors	LED Function†	Connection**	Inputs
Standard Audible	Sealed Audible				
TL50RAQ	TL50RALSQ	1	Red	4-pin Euro integral QD connector	Bimodal (NPN or PNP)
TL50GRAQ	TL50GRALSQ	2	Green, Red		
TL50GYRAQ	TL50GYRALSQ	3	Green, Yellow, Red	5-pin Euro integral QD connector	
TL50BGYRAQ	TL50BGYRALSQ	4	Blue, Green, Yellow, Red	8-pin Euro integral QD connector	

† The first color listed is the bottom color, going up in successive order. Contact factory for other colors and color combinations.

* Models with black housing are listed. For gray housing, add suffix **C** at the end of model number (cabled models) or before the **Q** (QD models), e.g., **TL50GYRC** or **TL50GYRCQ**.

** Integral QD models only are listed; mating cordset required (see [Quick-Disconnect \(QD\) Cordsets](#) on page 4):

- For 150 mm PVC pigtail with QD, replace **Q** with **QP** in model number (e.g., **TL50GYRQP**).
- For 2 m (6.5') cable, omit suffix **Q** from model number (e.g., **TL50GYR**).

Specifications

Supply Voltage and Current

18 to 30V dc (10% max. ripple); or 21 to 27V ac

Indicators: @ 45 mA max. current per LED color

Standard Audible Alarm: 25 mA max. current

Sealed Audible Alarm: 35 mA max. current

Indicators

LEDs are independently selected, 1-5 colors depending on model; see models table

Supply Protection Circuitry:

Protected against reverse polarity, transient voltages

Input Response Time

Indicator ON/OFF: 10 ms (max.)

Audible Adjustment

Standard Audible Alarm: Unscrew the cover (up to 1.5 turns max.) to adjust the audible intensity. (Do not exceed 1.5 turns or the cover may detach during operation.) For max. intensity, rotate the center plug 180° counterclockwise to remove it.

Sealed Audible Alarm: Rotate the front cover until the desired intensity is reached.

Connections

Integral 4-pin, 5-pin or 8-pin M12/Euro-style QD, 150 mm PVC pigtail with QD, or 2 m (6.5') integral cable, depending on model

Vibration and Mechanical Shock:

All models meet Mil. Std. 202F requirements method 201A (vibration: 10 to 60 Hz max., double amplitude 0.06", maximum acceleration 10G). Also meets IEC 947-5-2; 30G 11 ms duration, half sine wave.

Operating Conditions:

General-Purpose: -40° to +50° C (-40° to +122° F)

Standard and Sealed Audible: -20° to +50° C (-4° to +122° F)

Max. Rel. Humidity: 95% @ 50° C (non-condensing)

Audible Alarm

Audible measurements are made in the direction sound exits the device. For standard audible models, this is the top of the unit (when mounted vertically, sound is directed toward the ceiling). For sealed audible models, sound exits the vented openings in the side of the unit, which should be oriented so that the sound is directed toward the machine operator(s). In environments with high ambient noise levels or high ceilings that absorb sound, the sealed version is recommended.

Standard Audible Alarm: 2.7 KHz ± 500 Hz oscillation frequency; max. intensity 92 db @ 1 meter (typical)

Sealed Audible Alarm: 2.9 KHz ± 250 Hz oscillation frequency; max. intensity 94 db @ 1 meter (typical)

Construction:

Bases and Covers: ABS

Light Segment: Polycarbonate

Environmental Rating

General-Purpose and Sealed Audible: IEC IP67

Standard Audible: IEC IP50

Certifications



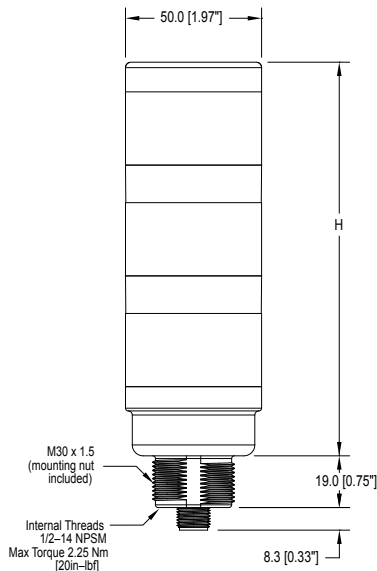

# of Colors	Tower Height (H)		
	General-Purpose Models	Standard Audible Models†	Sealed Audible Models
1	61.2 mm (2.4")	92.0 mm (3.6")	115.1 mm (4.5")
2	101.9 mm (4.0")	132.7 mm (5.2")	155.8 mm (6.1")
3	142.6 mm (5.6")	173.4 mm (6.8")	196.5 mm (7.7")
4	183.3 mm (7.2")	214.1 mm (8.4")	237.2 mm (9.3")
5	224.0 mm (8.8")	—	—

† Tower height (H) with top unscrewed approximately 3.5 mm to allow sound to escape

Hookups – 4-Pin Models

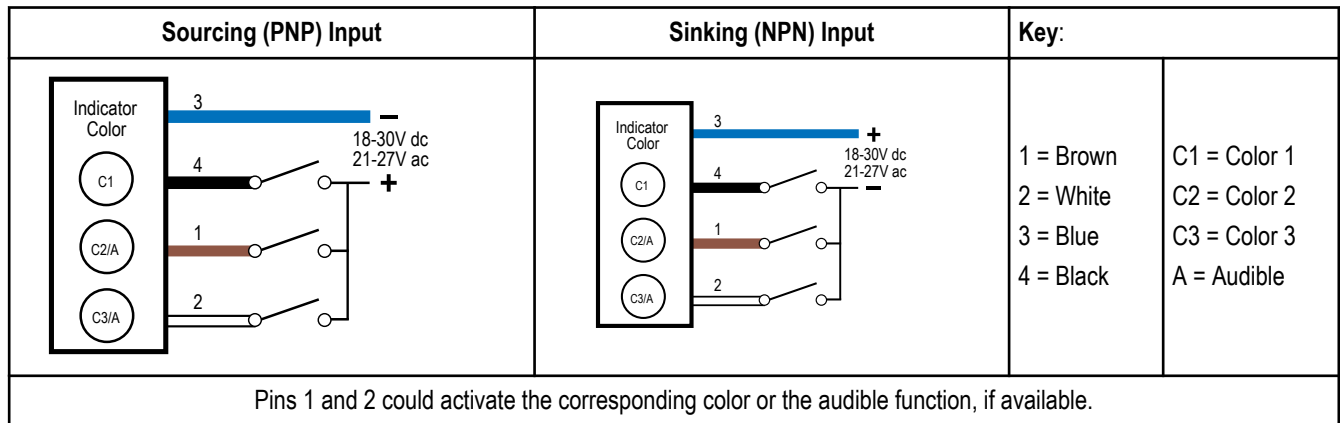

Hookups – 5-Pin Models

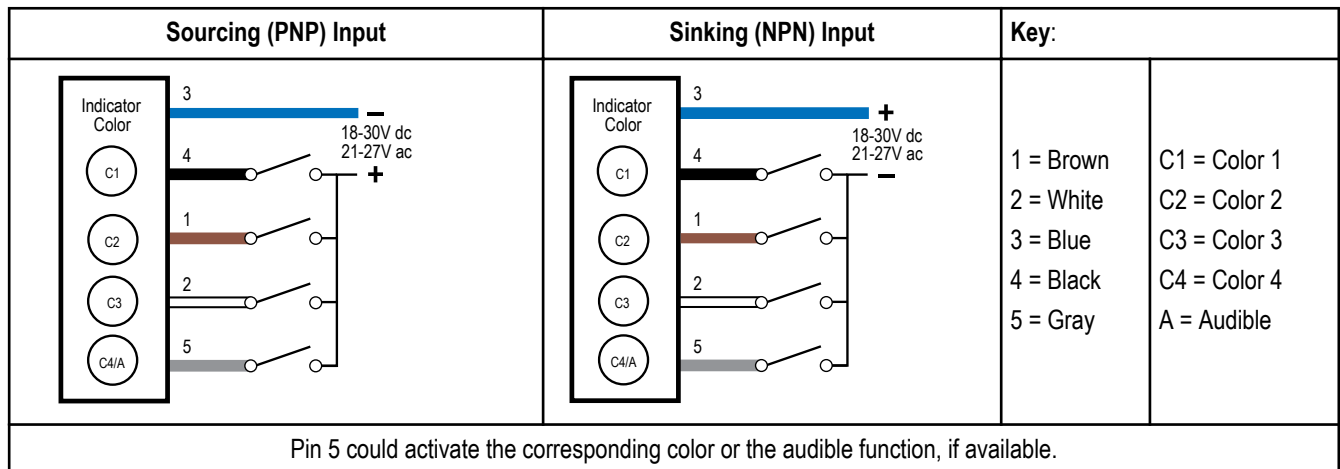

Hookups – 8-Pin Models

Sourcing (PNP) Input	Sinking (NPN) Input	Key:	
		<p>1 = White</p> <p>2 = Brown</p> <p>3 = Green</p> <p>4 = Yellow</p> <p>5 = Gray</p> <p>6 = Pink</p> <p>7 = Blue</p> <p>8 = Red</p>	<p>C1 = Color 1</p> <p>C2 = Color 2</p> <p>C3 = Color 3</p> <p>C4 = Color 4</p> <p>C5 = Color 5</p> <p>A = Audible</p>
<p>Pin 4 could activate the corresponding color or the audible function, if available. Pins 3 and 8 are not used.</p>			

Quick-Disconnect (QD) Cordsets

4-Pin M12/Euro-Style Cordsets (straight connector)

- MQDC-406, 2 m (6.5')
- MQDC-415, 5 m (15')
- MQDC-430, 9 m (30')

5-Pin M12/Euro-Style Cordsets (straight connector)

- MQDC1-506, 2 m (6')
- MQDC1-515, 5 m (15')
- MQDC1-530, 9 m (30')

5-Pin M12/Euro-Style Cordsets (right-angle connector)

- MQDC1-506RA, 2 m (6')
- MQDC1-515RA, 5 m (15')
- MQDC1-530RA, 9 m (30')

8-Pin M12/Euro-Style Cordsets with Open-Shield (straight connector)

- MQDC-806, 2 m (6.5')
- MQDC-815, 5 m (15')
- MQDC-830, 9 m (30')

Mounting Brackets

All measurements in mm

SMB30A

- Right-angle bracket with curved slot for versatile orientation
- Clearance for M6 (1/4") hardware
- 30 mm mounting hole
- 12-ga. stainless steel

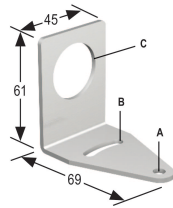

Hole center spacing: A to B=40.0

Hole size: A=∅ 6.3, B=27.3 x 6.3, C=∅ 30.5

SMB30SC

- Swivel bracket with 30 mm mounting hole
- Black reinforced thermo-plastic polyester
- Stainless steel mounting and swivel locking hardware included

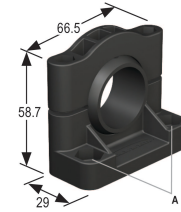

Hole center spacing: A to B=50.8

Hole size: A=∅ 7.0

SMB30FA

- Swivel bracket with tilt and pan movement for precision adjustment
- 30 mm mounting hole
- 12-ga. 304 stainless steel

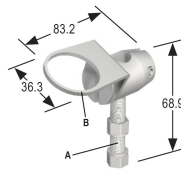

A=3/8 - 16 x 50.8

Hole size: B=∅ 30.1

SMBAMS30P

- Flat SMBAMS series bracket
- 30 mm mounting hole
- Articulation slots for 90+° rotation
- 12-ga. 300 series stainless steel

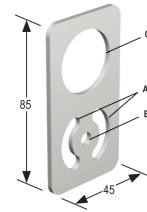

Hole center spacing: A=26.0, A to B=13.0

Hole size: A=26.8 x 7.0, B=∅ 6.5, C=∅ 31.0

SMB30MM

- 12-ga. stainless steel bracket with curved mounting slots for versatility and orientation
- Clearance for M6 (1/4") hardware
- 30 mm mounting hole

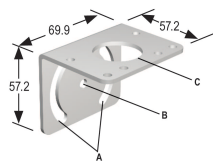

Hole center spacing: A=51.0, A to B=25.4

Hole size: A=42.6 x 7.0, B=∅ 6.4, C=∅ 30.1

SMBAMS30RA

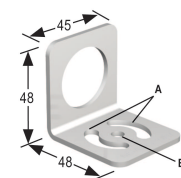

- Right-angle SMBAMS series bracket
- 30 mm mounting hole
- Articulation slots for 90+° rotation
- 12-ga. cold rolled stainless steel



Hole center spacing: A=26.0, A to B=13.0

Hole size: A=26.8 x 7.0, B=∅ 6.5, C=∅ 31.0

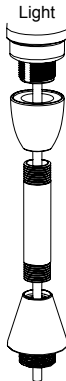
Elevated Mount System

Model		Features	Components	
SA-M30TE12		<ul style="list-style-type: none"> Streamlined acetal stand-off pipe adapter/cover Connects between 30 mm light base and ½" NPSM/DN15 pipe Mounting hardware included 		
Stainless Steel	Aluminum	<ul style="list-style-type: none"> Elevated-use stand-off pipe (½" NPSM/DN15) Polished 304 stainless steel or black anodized aluminum surface ½ NPT thread at both ends Compatible with most industrial environments 		
SOP-E12-150SS 150 mm (6") long	SOP-E12-150A 150 mm (6") long			
SOP-E12-300SS 300 mm (12") long	SOP-E12-300A 300 mm (12") long			
SOP-E12-900SS 900 mm (36") long	SOP-E12-900A 900 mm (36") long			
SA-E12M30		<ul style="list-style-type: none"> Streamlined acetal mounting base adapter/cover Connects between ½" NPSM/DN15 pipe and 30 mm (1-3/16") drilled hole Mounting hardware included 		

Contact Us

For more information: Contact your local Banner representative or Banner Corporate Offices around the world.

Corporate Headquarters: Banner Engineering Corp. 9714 Tenth Ave. North, Mpls., MN 55441, Tel: 763-544-3164, www.bannerengineering.com, sensors@bannerengineering.com

Europe: Banner Engineering Europe Park Lane, Culliganlaan 2F, Diegem B-1831 BELGIUM, Tel: 32-2 456 07 80, Fax: 32-2 456 07 89, www.bannereurope.com, mail@bannereurope.com

Latin America: Contact Banner Engineering Corp. (US) or e-mail **Mexico:** mexico@bannerengineering.com; or **Brazil:** brasil@bannerengineering.com

Asia:

Banner Engineering China Shanghai Rep Office Rm. G/H/I, 28th Flr. Cross Region Plaza No. 899, Lingling Road, Shanghai 200030 CHINA, Tel: 86-21-54894500, Fax: 86-21-54894511, www.bannerengineering.com.cn, sensors@bannerengineering.com.cn

Banner Engineering Japan Cent-Urban Building 305 3-23-15, Nishi-Nakajima Yodogawa-Ku, Osaka 532-0011 JAPAN, Tel: 81-6-6309-0411, Fax: 81-6-6309-0416, www.bannerengineering.co.jp, mail@bannerengineering.co.jp

Banner Engineering Asia — Taiwan Neihu Technology Park 5F-1, No. 51, Lane 35, Jihu Rd., Taipei 114 TAIWAN, Tel: 886-2-8751-9966, Fax: 886-2-8751-2966, www.bannerengineering.com.tw, info@bannerengineering.com.tw

Banner Engineering India Pune Head Quarters Office, No. 1001 Sai Capital, Opp. ICC Senapati Bapat Road, Pune 411016 INDIA, Tel: 91-20-66405624, Fax: 91-20-66405623, www.bannerengineering.co.in, india@bannerengineering.com



Warranty: Banner Engineering Corporation warrants its products to be free from defects for a period of one year. Banner Engineering Corporation will repair or replace, free of charge, any product of its manufacture found to be defective at the time it is returned to the factory during the warranty period. This warranty does not cover damage or liability for the improper application of Banner products. This warranty is in lieu of any other warranty either expressed or implied.