

Features

- Miniature SIL Package
- FM Narrow Band
- Fully Shielded
- Narrow Band Crystal Stabilised
- Data Rates Up To 20 Kbits/S
- En 300-220 Compliant
- Data & AF Out
- CD Implemented On Data Output
- RSSI Output
- Selective Ceramic IF Filters

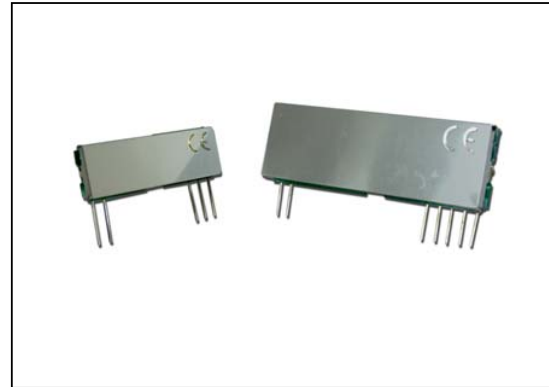

T7/R7 Modules

- Wide Operating Voltage (2.2 - 10 Vdc).
- Optimal Range 600 metres

T7G/R7G Modules

- 3 or 5 Volt Operating Voltage
- 3 Channels available from Stock
- Optimal Range 1,000 metres

Applications

- Telemetry Systems
- Wireless Networking
- Domestic And Commercial Wireless Security Systems
- Panic Attack Facility
- Remote Control For Cranes Etc

General Description

The T7/R7 series are miniature narrow band transmitter and receiver UHF radio modules, which enable the implementation of a simple telemetry link at data rates up to 20Kbits/s.

These narrow band UHF radio modules provide a very high RF performance for general purpose applications.

The transmitter modules have a power output of up to 25mW. When combined with a very high receiver sensitivity these modules obtain a very high performance of range and reliability within the 433MHz band.

Available for operation between 433.075 and 434.725 MHz in 25KHz steps there are currently 3 different frequency channels available from stock. (others available to special order)

The T7G and R7G genesis modules represent the latest generation of narrow band transmitters. They retain the same industry standard footprints and are fully compatible with the T7 and R7 modules to enable incorporation into both new and existing designs. The improved sensitivity of the R7G enables a range of up to 1Km when used with the T7G modules.



FM 433MHz Narrow Band

T7 / R7
T7G / R7G

Frequency Channels

T7 / R7

These modules are available at 4345.075MHz only.

T7G / R7G

These modules are available in 34 discrete frequency channels from 433.075 to 434.725 MHz in 50KHz steps. The table below shows the list of possible frequency channels.

CH.	FREQ/MHz	CH.	FREQ/MHz
1	433.075(2)	18	433.925(2)
2	433.125(2)	19	433.975(2)
3	433.175(2)	20	434.025(2)
4	433.225(2)	21	434.075 (1)
5	433.275(2)	22	434.125(2)
6	433.325(2)	23	434.175(2)
7	433.375(2)	24	434.225(1)
8	433.425(2)	25	434.275(2)
9	433.475(2)	26	434.325 (2)
10	433.525(2)	27	434.375(2)
11	433.575(2)	28	434.425(2)
12	433.625(2)	29	434.475(2)
13	433.675(2)	30	434.525 (1)
14	433.725(2)	31	434.575(2)
15	433.775(2)	32	434.625(2)
16	433.825(2)	33	434.675(2)
17	433.875(2)	34	434.725(2)

- (1) Stock Item
- (2) Future Development





Absolute Maximum Ratings: Transmitter (all voltage versions)

	T7		T7G	
	Min.	Max.	Min.	Max.
Operating Temperature	-25°C	+55°C	-10°C	+55°C
Storage Temperature	-40°C	+100°C	-40°C	+100°C
Supply Voltage	-	12V	-	5.5V
Data Input	-	10V	-	5.5V

Electrical Characteristics: Transmitter

	T7			T7G			Units	Pin	Notes
	Min.	Typ.	Max.	Min.	Typ.	Max.			
DC Levels									
Supply (5V variants)	2.2	5.0	12.0	4.5	5.0	5.5	Volts	3	
Supply (3V variants)	-	-	-	2.2	3.0	4.0	Volts	3	
Current & RF Power									
Supply current @ V _{CC} = 5V		7			24		mA	3	1
RF output power @ V _{CC} = 5V		3			25		mW	2	1
Supply current @ V _{CC} = 3V		-			22		mA	3	1
RF output power @ V _{CC} = 3V		-			13		mW	2	1
RF & Data (All Variants)									
2 nd harmonic		-60			-40		dBm		2
Harmonics @ > 1GHz		-60			-50		dBm		2
Initial frequency accuracy		+/-25			+/-25		Hz		
Frequency accuracy over full temp range			+/-30			±27	KHz		
Modulation bandwidth @ -3dB		20			30		KHz		3
Power up time to full RF		5			5		ms		
Data rate			20			20	kbits/s		
Data pulse width	50			50			µs		

Notes

1. Measured into a 50Ω impedance.
2. The limit for the European spec EN 300 220 is -36dBm
3. A +/-2.5KHz Deviation on the RF carrier is also available

Part No	Description
T7-434-075	SIL Transmitter 434.075MHz
T7G-434-075	SIL Transmitter 434.075MHz
T7G-434-075-3V	SIL Transmitter 434.075MHz, 3 Volt version
T7G-434-225	SIL Transmitter 434.225MHz
T7G-434-525	SIL Transmitter 434.525MHz
T7G-434-525-3V	SIL Transmitter 434.525MHz, 3 Volt version





Absolute Maximum Ratings: Receiver

	R7		R7G	
	Min.	Max.	Min.	Max.
Operating Temperature	-10°C	+55°C	-10°C	+55°C
Storage Temperature	-40°C	+100°C	-40°C	+100°C
Supply Voltage	-	7V	-	5.5V
RF Input	-	+20dBm (100mW)	-	+10dBm (10mW)

Note: Receiver modules with operating temperatures from -40°C to +80°C are also available

Electrical Characteristics: Receiver

	R7			R7G			Units	Notes
	Min.	Typ.	Max.	Min.	Typ.	Max.		
DC Levels								
Supply voltage	4.5	5	5.5	4.5	5	5.5	V	
Supply current		6	7		11		mA	
Supply ripple	-	-	10			10	mV _{P-P}	
Data output high		=>4.5			=>4.0		V	
Data output low		<=0.5			<=0.5		V	
RF								
RF sensitivity		-113			-117		dBm	2
IF Bandwidth		+/-27			+/-27		KHz	
Initial frequency accuracy		+/-100			+/-25		Hz	
Max R.F. input		20			10		dBm	
E.M.C.								
Spurious responses up to 1GHz		<60			<60		dB	
LO leakage, conducted		<60			<60		dBm	
LO leakage, radiated		<60			<60		dBm	
Image rejection		63			35		dB	
DYNAMIC TIMING								
Power up to stable data (With RF signal present)		18	23		110		mS	1
Signal to stable data (With PSU already on)		2.5	5		1		mS	1
Power up to valid RSSI (With RF signal Present)		3	5		2.5	3.5	mS	1
Mark:space ratio		50			50		%	
Bit rate	100		20000	100		20000	Bps	3

Notes

1. Timings are to be confirmed.
2. For R7G: For 12dB SINAD from the AF output
3. Note 1Hz = 2 bps

Part No	Description
R7-434-075	SIL Receiver 434.075MHz
R7G-434-075	SIL Receiver 434.075MHz
R7G-434-225	SIL Receiver 434.075MHz
R7G-434-525	SIL Receiver 434.075MHz



Transmitter Connection Diagram

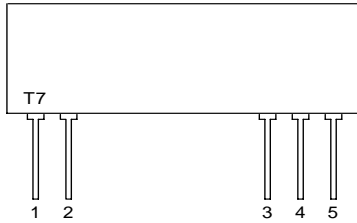

Figure 1: Narrow Band T7 / T7G Transmitters

Receiver Connection Diagram

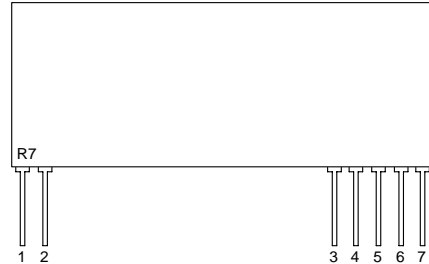

Figure 2: Narrow Band R7 / R7G Receivers

Pin Description:

RF GND (*pin 1*)

RF ground pin, internally connected to pin 4 (0v). This pin should ideally be connected to the nearest ground plane (e.g coax braid, main PCB ground plane etc.).

RF OUT (*pin 2*)

50 Ohm RF antenna output. To achieve best results, the antenna impedance must match that of the module.

Vcc (*pin 3*)

+Ve supply pin. The module will generate RF when Vcc is present.

GND (*pin 4*)

Supply and data ground connection, connected to pin 1.

Data IN (*pin 5*)

This input has an impedance of 47K Ohms and should ideally be driven by a CMOS logic drive or compatible. The drive circuitry should be supplied with the same supply voltage as the TX module.

Pin Description:

RF IN (*pin 1*)

50 Ohm RF input from antenna, connect using shortest possible route. This input is isolated from the internal circuit using the air gap of the front end SAW RF filter.

RF GND (*pin 2*)

RF Ground connection, preferably connected to a solid ground plane.

RSSI / Carrier Detect (*pin 3*)

The Received Signal Strength Indicator provides a DC output voltage proportional to the RF input signal. The amplitude of the RSSI voltage increases with increasing RF signal strength. A simple transistor interface can yield a carrier detect logic output.

GND (*pin 4*)

Connect to power supply ground.

VCC (*pin 5*)

+Ve supply pin. Operation from a 5V supply able to source 10mA at less than 10mV p-p ripple.

AF (*pin 6*)

Audio frequency output (max 40microA source)

DATA OUT (*pin 7*)

CMOS compatible output. This may be used to drive external decoders. To reduce any noise on this output add a 56pF cap from this pin to GND.

Application Information

Antenna Design

The design and positioning of the antenna is as crucial as the module performance itself in achieving a good wireless system range. The following will assist the designer in maximising system performance.

The antenna should be kept as far away from sources of electrical interference as physically possible. If necessary, additional power line decoupling capacitors should be placed close to the module.

The antenna 'hot end' should be kept clear of any objects, especially any metal as this can severely restrict the efficiency of the antenna to receive power. Any earth planes restricting the radiation path to the antenna will also have the same effect.

Best range is achieved with either a straight piece of wire, rod or PCB track @ $\frac{1}{4}$ wavelength (15.5cm @ 433.92MHz). Further range may be achieved if the $\frac{1}{4}$ wave antenna is placed perpendicular in the middle of a solid earth plane measuring at least 16cm radius. In this case, the antenna should be connected to the module via some 50 ohm characteristic impedance coax

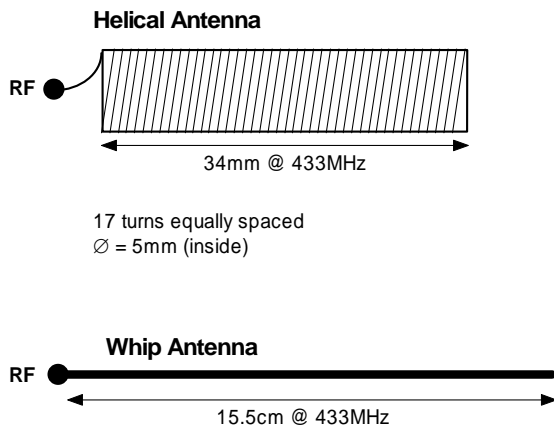

Figure 4: Antenna Configurations To Be Used With The FM Narrow Band Transmitter & Receiver Modules

Application Circuit

The application circuits show how the FM narrow band transmitter and receiver modules can easily be integrated into a system to form a wireless link.

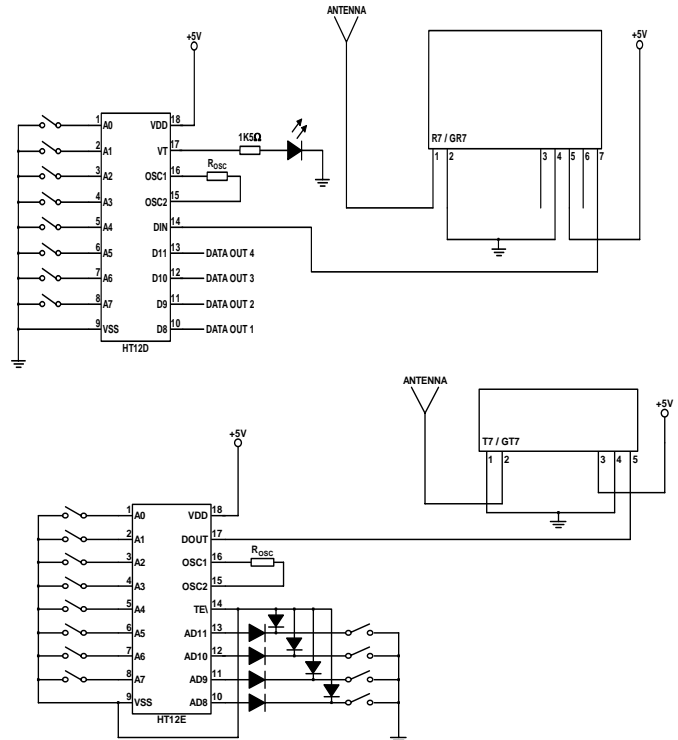
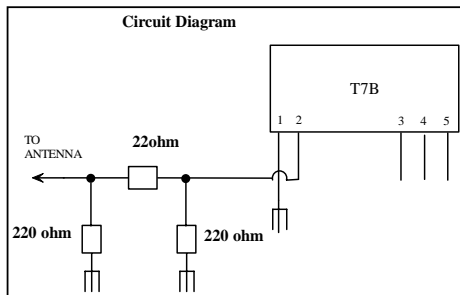

Figure 5: FM Narrow Band Transmitter & Receiver Application Circuits

Reducing Power to 10mW

If the T7G transmitter will be used with an efficient antenna in countries where only 10mW radiated power is allowed, then a simple resistive network on the output of the module will attenuate the power down to this level.



When laying out this network, keep all tracks as short as possible, especially ground paths and use 50 ohm track impedances when connecting to and from this network. This impedance can be realised on 1.6mm FR4 pcb by using a track width of 2.5mm.

RSSI Values

The R7 / R7G receiver RSSI outputs provide a DC output proportional to the RF signal. The table below shows the typical RSSI value depending on the Signal strength.

RF Signal Strength/dBm	R7 (V)	GR7 (V)
-130	1.03	1.25
-120	1.06	1.32
-110	1.16	1.46
-100	1.34	1.69
-90	1.59	1.96
-80	1.78	2.2
-70	1.81	2.47
-60	1.81	2.5
-50	2.17	2.5
-40	2.45	-
-30	2.52	-
-20	2.52	-

Notice that the region between -80 to -60 is with the receiver agc operating. If required, a receiver version with agc disabled can be provided as a factory Pre-set option. This would linear-rise the RSSI curve.

Mechanical Dimensions

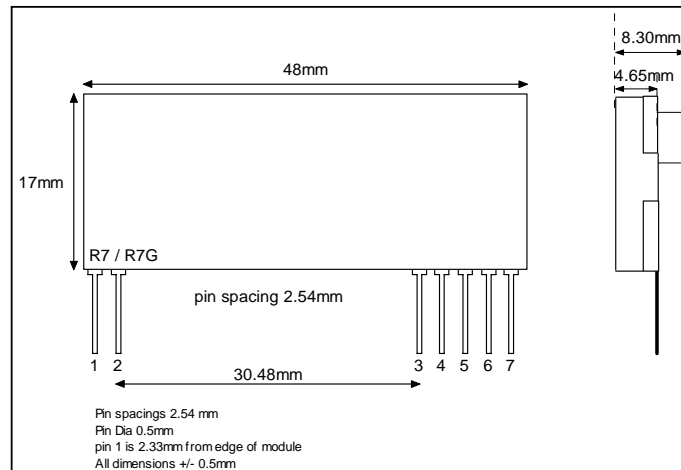
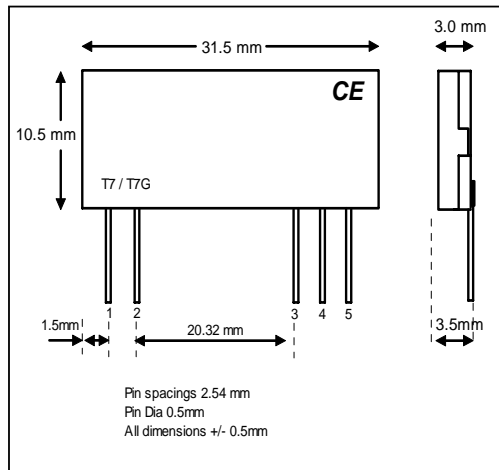

**R F Solutions Ltd.,
Unit 21, Cliffe Industrial Estate,
South Street, Lewes,
E. Sussex. BN8 6JL, England**

Tel: +44 (0)1273 898 000

Email : sales@rfsolutions.co.uk

Fax: +44 (0)1273 480 661

http://www.rfsolutions.co.uk

Information contained in this document is believed to be accurate, however no representation or warranty is given and no liability is assumed by R.F. Solutions Ltd. With respect to the accuracy of such information. Use of R.F.Solutions as critical components in life support systems is not authorised except with express written approval from R.F.Solutions Ltd.