

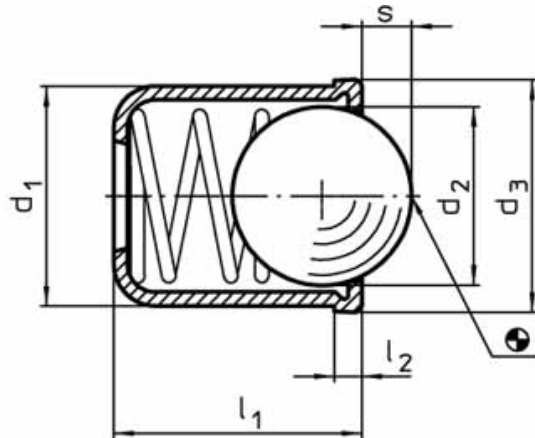

Part Number : 3230













**Material and Technical Notes**

Body: stainless steel 1.4305, brass, or Delrin blue. Ball: stainless steel, hardened or Delrin white (POM). Spring: stainless steel.

Used for locating, applying pressure or lifting off. Spring loads \* = statistical average values.

These are press fit spring plungers. Typical hole tolerance is J6, but this varies with type of material so a trial hole is recommended.

ORDER/PRICE	Order No.	Finish	$d_1$	$d_2$	$d_3$	$l_1$	$l_2$	$s$	Spring Load*	Spring Load*	max.	
			+0,1						$F_1$	$F_2$	$^{\circ}C$	g
									$N \alpha$	$N \alpha$		
ORDER/PRICE	3230.W004	Body & ball Stainless steel	4	3,0	4,6	5,0	1,5	0,8	2,5	6,0	250	0,35
ORDER/PRICE	3230.W005	Body & ball Stainless steel	5	4,0	5,6	6,0	1,5	1,0	3,0	6,5	250	0,60
ORDER/PRICE	3230.W006	Body & ball stainless steel	6	5,0	6,5	7,0	1,5	1,6	5,5	11,5	250	1,00
ORDER/PRICE	3230.W008	Body & ball stainless steel	8	6,5	8,5	9,0	1,5	1,9	7,0	12,5	250	2,20
ORDER/PRICE	3230.W010	Body & ball stainless	10	8,5	11,0	13,5	2,5	3,1	8,5	18,5	250	5,30

		steel											
 ORDER/PRICE	3230.W012	Body & ball stainless steel	12	10,0	13,0	16,0	2,5	3,8	12,0	26,5	250	7,80	
 ORDER/PRICE	3230.W204	Body: brass, ball stainless steel	4	2,5	4,5	5,0	1,0	0,8	2,5	6,0	250	0,45	
 ORDER/PRICE	3230.W205	Body brass, ball stainless steel	5	3,5	5,5	6,0	1,0	1,0	3,0	6,5	250	0,80	
 ORDER/PRICE	3230.W206	Body brass, ball stainless steel	6	4,5	6,5	7,0	1,0	1,6	5,5	11,5	250	1,30	
 ORDER/PRICE	3230.W208	Body brass, ball stainless steel	8	6,0	8,5	9,0	1,0	1,9	7,0	12,5	250	2,90	
 ORDER/PRICE	3230.W404	Body Delrin, ball stainless steel	4	3,0	4,6	5,0	1,0	0,8	2,5	6,5	-0,6	0,20	
 ORDER/PRICE	3230.W405	Body Delrin, ball stainless steel	5	4,0	5,6	6,0	1,0	1,0	4,5	9,0	-0,6	0,40	
 ORDER/PRICE	3230.W406	Body Delrin, ball stainless steel	6	5,0	6,5	7,0	1,0	1,6	6,5	13,0	-0,6	0,70	
 ORDER/PRICE	3230.W408	Body Delrin, ball stainless steel	8	6,5	8,5	9,0	1,0	1,9	8,0	18,0	-0,6	1,50	
 ORDER/PRICE	3230.W604	Body & ball Delrin	4	3,0	4,6	5,0	1,0	0,8	2,5	6,5	-0,6	0,10	
 ORDER/PRICE	3230.W605	Body & ball Delrin	5	4,0	5,6	6,0	1,0	1,0	4,5	9,0	-0,6	0,20	
 ORDER/PRICE	3230.W606	Body & ball Delrin	6	5,0	6,5	7,0	1,0	1,6	6,5	13,0	-0,6	0,30	

 ORDER/PRICE	<b>3230.W608</b>	<b>Body &amp; ball Delrin</b>	<b>8</b>	6,5	8,5	9,0	1,0	1,9	8,0	18,0	-0.6	0,55
---	------------------	---------------------------------------	----------	-----	-----	-----	-----	-----	-----	------	------	------

