

New
FIBOX CAB - YELLOW

969-126 TO 710

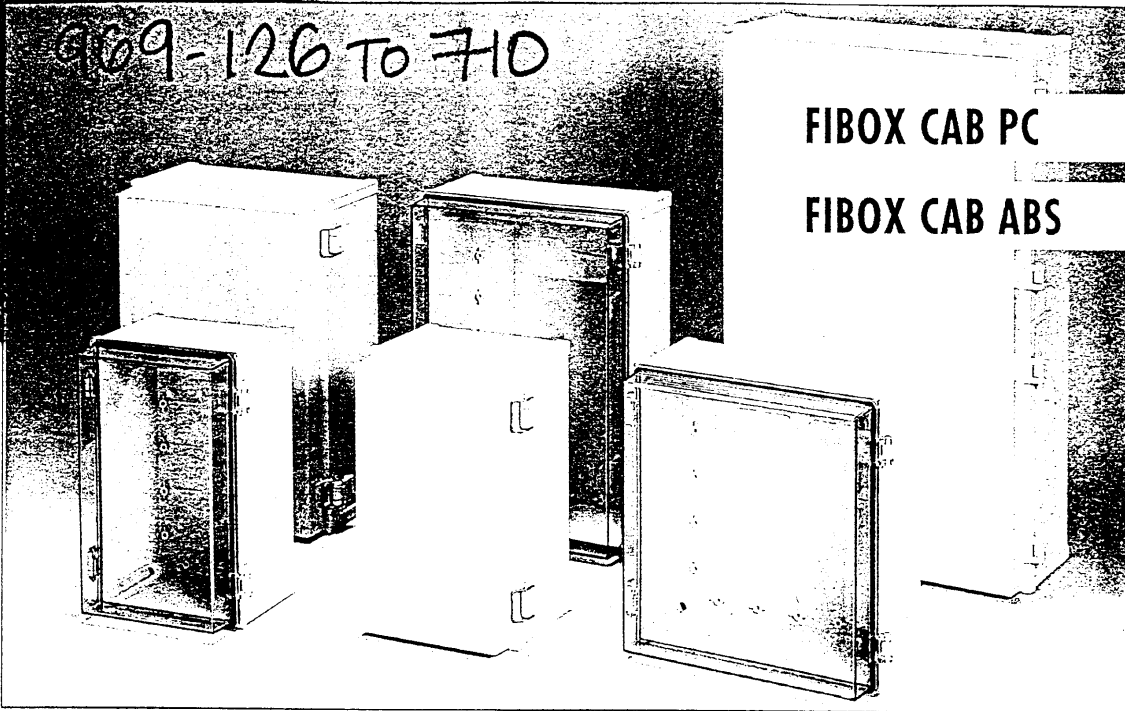

FIBOX CAB PC

FIBOX CAB ABS

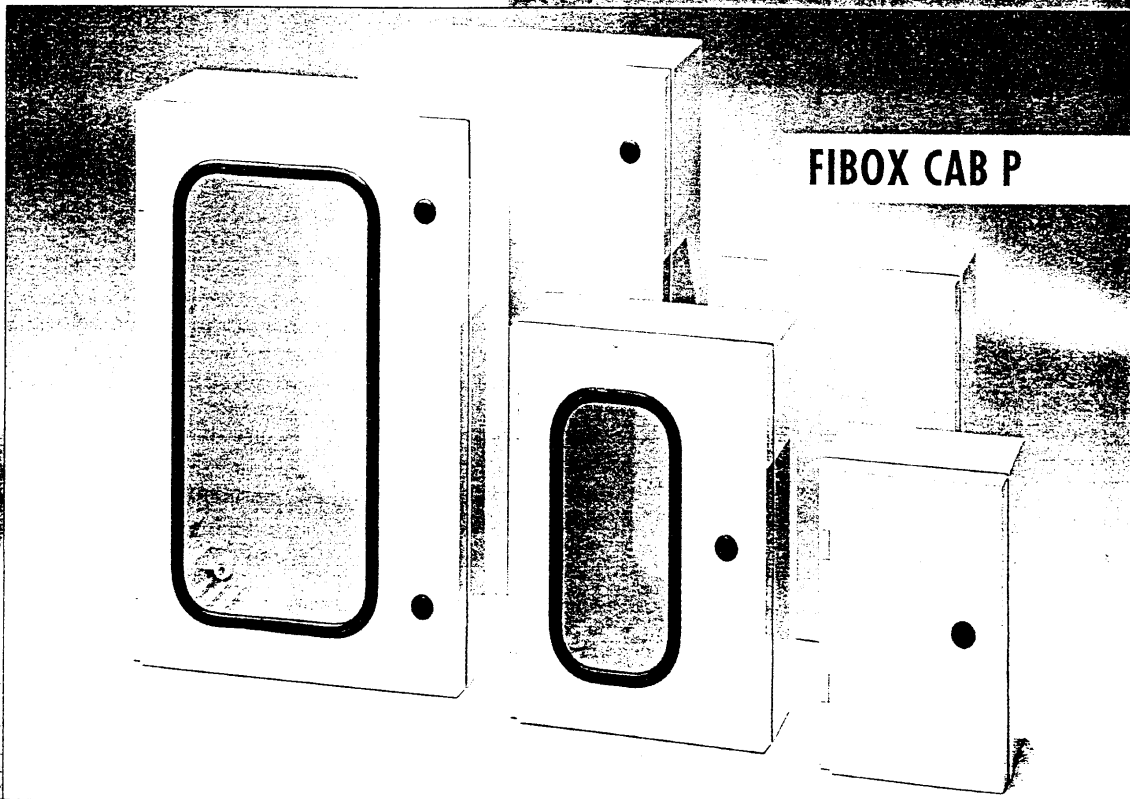

FIBOX CAB P

Large selection of polycarbonate, ABS and polyester wall mounting cabinets with swing-door option.

FIBOX

) X C A B -

F I B C

FIBOX CAB PC

FIBOX CAB ABS

POLYCARBONATE/ABS

Polycarbonate and ABS offer good design c wall mounting cabinets combined with easy machineability. Smoked transparent polycarbonate cover gives UV protection for installed equipment and good optics.

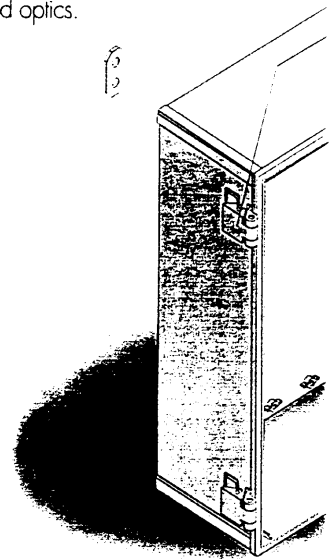

MOUNTING RAILS AND PLATES

Spacers for optimum depth mounting of DIN rails and fitting. Polycarbonate front plates in light blue colour (us:color). Metal mounting plates for all sizes available.

SWING DOOR

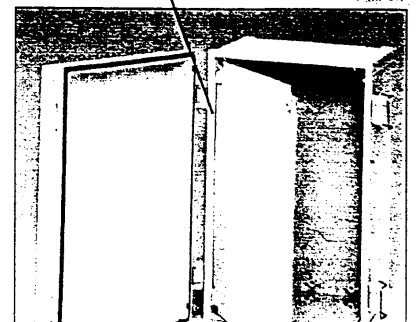

WW

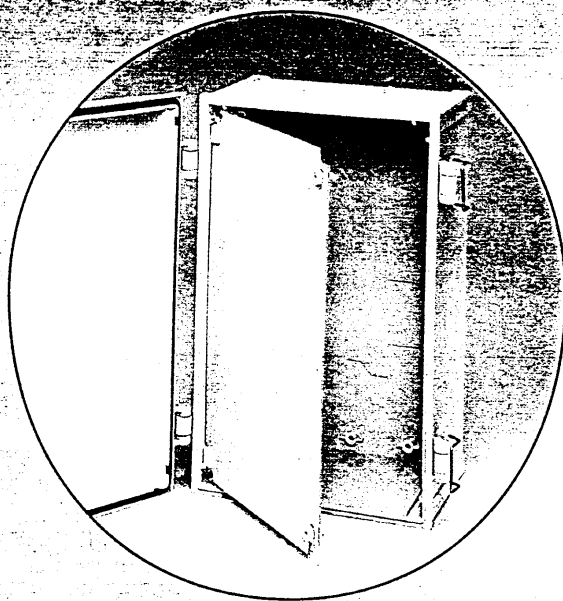

D

NXS-X

A B C

FIBOX

COMPARISON OF MATERIALS

The following table gives a general idea of the properties of the various types of cabinets. For more detailed information on material performance in your specific application environment, please consult your local FIBOX representative.

	PC	ABS	GRP
Outdoor use	****	*	*****
Indoor use	*****	*****	*****
Cost	***	*****	**
Light weight	*****	*****	***
High rigidity	***	*	****
Impact resistance	*****	***	****
CHEMICAL RESISTANCE			
Salt water environments	*****	**	*****
Neutral salts	*****	*****	*****
Acids, low concentrations	*****	****	*****
Acids, high concentrations	***	*	***
Alkalis, low concentrations	***	*****	****
Alkalis, high concentrations	*	****	****
Petroleum	***	*	*****
Hydraulic oil	*****	*****	*****
Alcohols	****	***	****
Solvents	*	*	*****
Cooling fluids	***	*****	*****

**** = EXCELLENT...

* = POOR

FIBOX CAB PC

FIBOX CAB ABS

POLYCARBONATE/ABS

Polycarbonate and ABS offer good design of wall mounting cabinets combined with easy machineability. Smoked transparent polycarbonate cover gives UV protection for installed equipment and good optics.

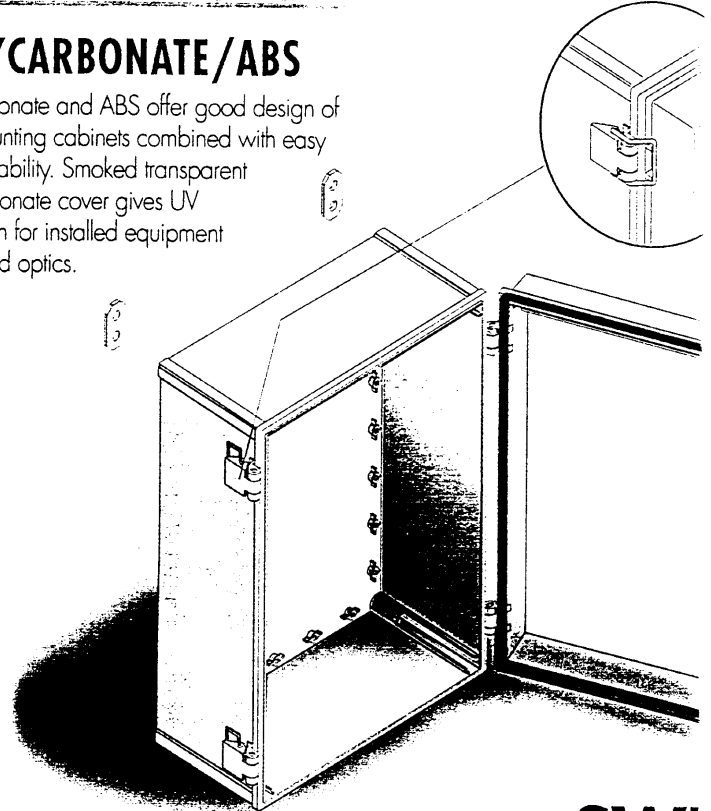

**SWI
DO**

MOUNTING RAILS AND PLATES

Spacers for optimum depth mounting of DIN rails and fitting. Polycarbonate front plates in light blue colour (us:color). Metal mounting plates for all sizes available.

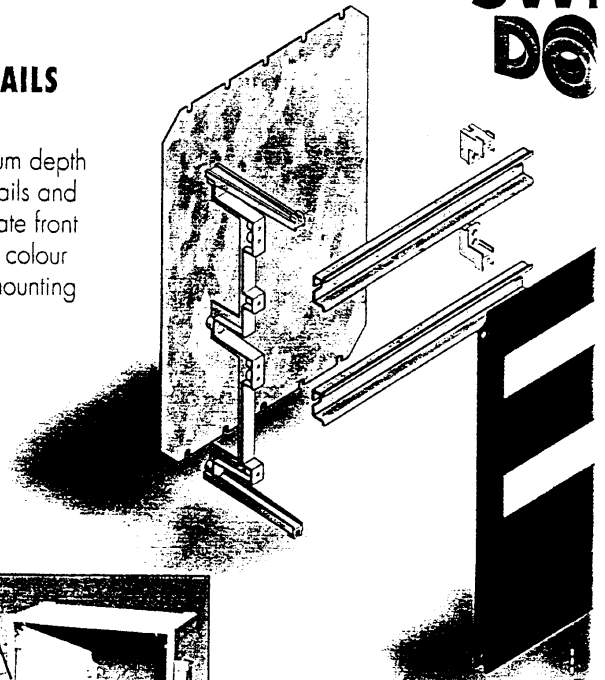

**SWING
DOOR**



**SWING OUT DOOR
FOR INSTRUMENTATION**

E L L O W L I N E

ORDERING INFORMATION FIBOX CAB PC/ABS SIZES XS TO XXL

SIZE Width x Height x Depth	ORDER SYMBOL	
	PC	ABS
200x300x180 200x300x180 200x300x180	CAB PC 302018 G/T CAB PC 203018 G/T *) CAB PC 302018 G3B/T3B	CAB ABS 302018 G/T CAB ABS 203018 G/T *) CAB ABS 302018 G3B/T3B
300x300x180 300x300x180	CAB PC 303018 G/T CAB PC 303018 G3B/T3B	CAB ABS 303018 G/T CAB ABS 303018 G3B/T3B
400x300x180 400x300x180 400x300x180	CAB PC 403018 G/T CAB PC 304018 G/T *) CAB PC 403018 G3B/T3B	CAB ABS 403018 G/T CAB ABS 304018 G/T *) CAB ABS 403018 G3B/T3B
500x400x180 500x400x180 500x400x180	CAB PC 504018 G/T CAB PC 405018 G/T *) CAB PC 504018 G3B/T3B	CAB ABS 504018 G/T CAB ABS 405018 G/T *) CAB ABS 504018 G3B/T3B
600x400x180 600x400x180	CAB PC 604018 G/T CAB PC 604018 G3B/T3B	CAB ABS 604018 G/T CAB ABS 604018 G3B/T3B

G=grey, T=transparent smoked grey, 3B=3 mm double bit key *) Hinges on short sides

ACCESSORIES

SWING DOOR/FRONT PLATE (aluminium)

ORDER SYMBOL	SIZE
FP A 23	170x270
FP A 33	270x270
FP A 43	370x270
FP A 54	470x370
FP A 64	570x370

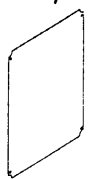

SWING DOOR KIT

ORDER SYMBOL	REMARKS
MB 12225	For size 604018 use 2 x



FRONT PLATES (PC blue)

ORDER SYMBOL	SIZE
FP PC 12-23	170x270
FP PC 12-33	270x270
FP PC 12x2-33	270x270
FP PC 12x2-43	370x270
FP PC 12x2-43 FP	370x270
FP PC 12x3-43	370x270

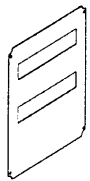

MOUNTING RAILS DIN 35

ORDER SYMBOL	REMARKS
EKIV 17	170 mm
EKIV 27	270 mm
EKIV 37	370 mm
EKIV 47	470 mm

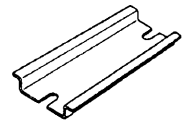

DIN RAIL SUPPORT

ORDER SYMBOL	REMARKS
FP 12190	400 mm For rail DIN 35 (for 400 mm side)

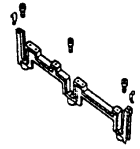

WALL FASTENING LUG

ORDER SYMBOL
FP 12017



MOUNTING PLATES (metal)

ORDER SYMBOL	SIZE
EKIV 23	170x270
EKIV 33	270x270
EKIV 43	370x270
EKIV 54	470x370
EKIV 64*	570x370

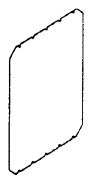

SPACER

ORDER SYMBOL	REMARKS
FA 12053	14 mm, steel
FA 12052	42 mm, steel
MB 10686 set	15/34 mm, PC screw use with FA 12053-FA 12052
M5x8	
MSM Kn 4.8x9.5	screw thread cutting screw for equipment mounting

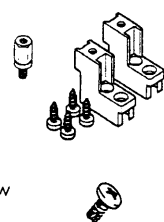

TECHNICAL INFORMATION

POLYCARBONATE (PC) or Glass fibre reinforced (PC+GLASS), Acrylnitrile-butadiene-styrene (ABS)

PROPERTY	PC CABINET	ABS CABINET
Ingress protection	IP 65 (IEC 529, EN 60529)	IP 65 (IEC 529, EN 60529)
Temperature range	- of material - 40 °C – + 120°C - in continuous use Max. + 80 °C	- 40 °C – + 80°C Max. + 60 °C
Impact resistance	Excellent	Excellent
Total insulation	☐	☐
Standard colour	Grey (RAL 7035)	Grey (RAL 7035)
Standard gasket material	EPDM	EPDM
Flame resistance	UL 94-V2, self-extinguishing	UL 94-HP, self-extinguishing

FIBOX CAB P

POLYESTER

Chemically resistant fibre glass reinforced polyester (GRP) cabinets available with both closed (G) and window (T) doors.

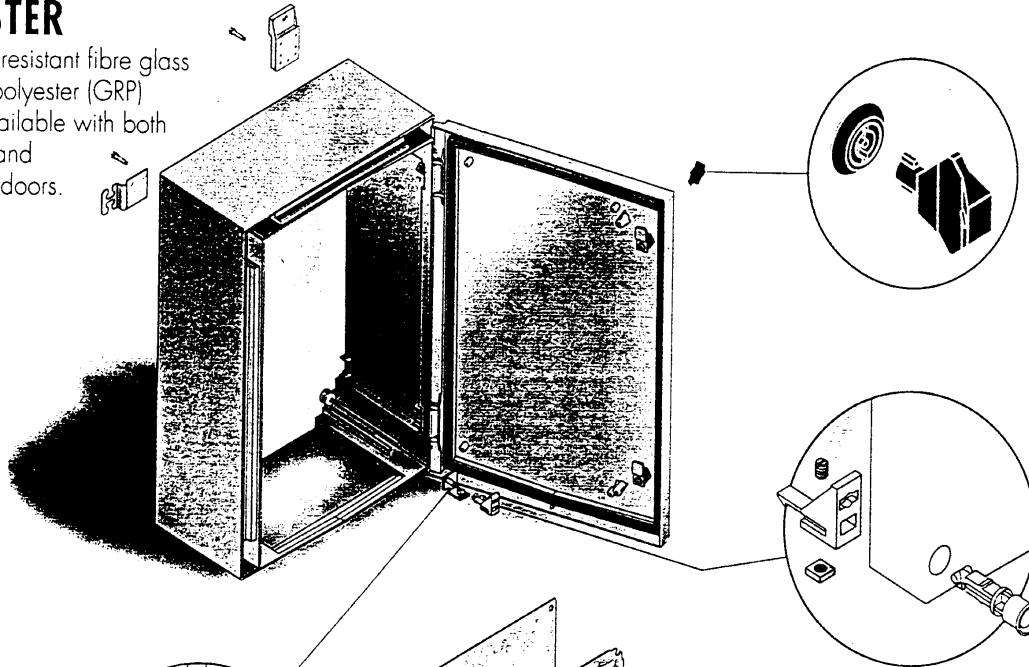

KEY LOCK AND WALL MOUNTING LUGS INCLUDED

The cabinets come with a standard 3 mm double bit lock and one plastic key. Sturdy plastic wall mounting lugs are also supplied with each cabinet.

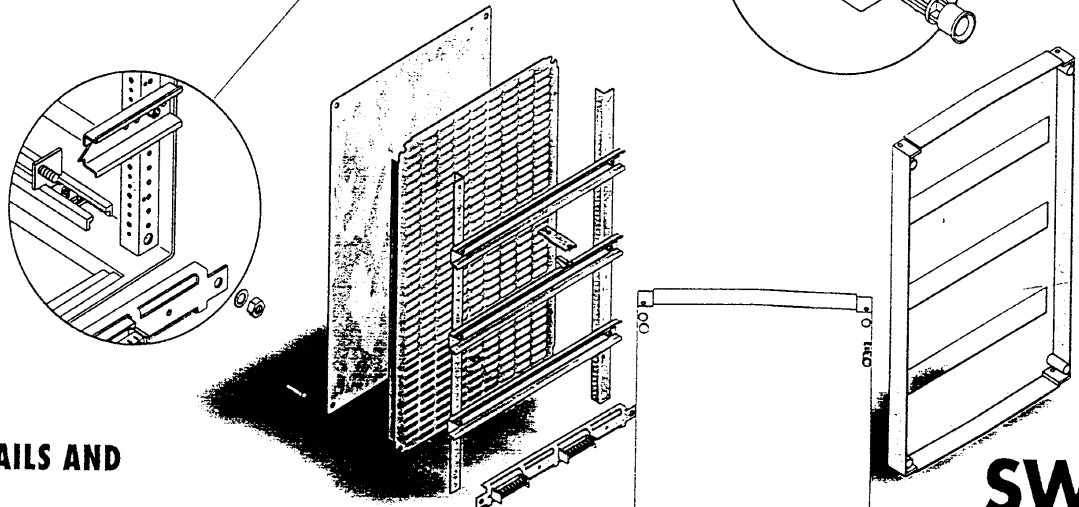

MOUNTING RAILS AND PLATES

A mounting rail kit for DIN components with optional earth bar bracket and plastic front plate with standard 45 mm openings are available. Metallic mounting plates and isolation (Pertinax) as well as perforated metal plates for all cabinet sizes.

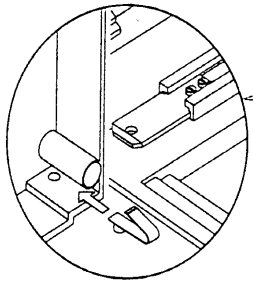

SWING OUT DOOR FOR INSTRUMENTATION

A rigid internal door can be mounted and hinged left or right. The thermoset plastic door offers a very sturdy surface for push buttons, displays, switches etc.

SWING DOOR

SWING DOOR

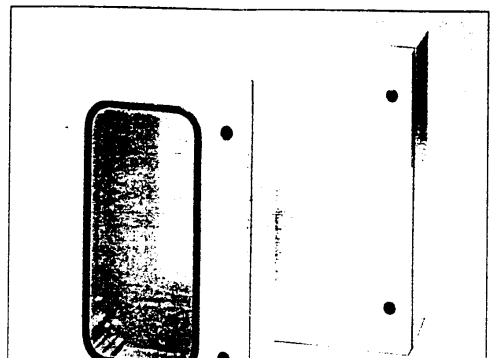
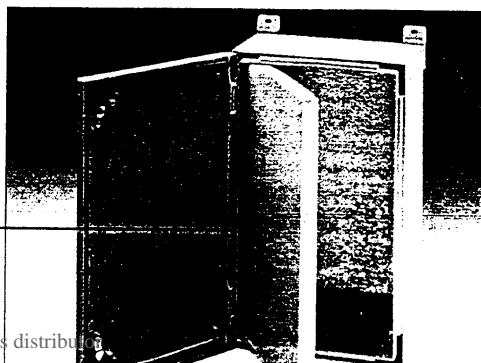

ORDERING INFORMATION FIBOX CAB P

SIZES XS TO XXL

SIZE Width x Height x Depth	ORDER SYMBOL	
	Polyester, grey door	Polyester, glazed door
300x200x170	CAB P 302017	
400x300x170	CAB P 403017	CAB P 403017T
500x400x230	CAB P 504023	CAB P 504023T
600x400x230	CAB P 604023	CAB P 604023T
700x500x270	CAB P 705027	CAB P 705027T
800x600x300	CAB P 806030	CAB P 806030T
1000x800x300	CAB P 1008030	CAB P 1008030T

ACCESSORIES

SWING DOOR/FRONT PLATE

FOR ENCLOSURES	ORDER SYMBOL
302017	FP 3020-D
403017	FP 4030-D
504023	FP 5040-D
604023	FP 6040-D
705027	FP 7050-D
806030	FP 8060-D
1008030	FP 10080-D

SWING DOOR

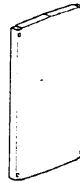

MOUNTING FRAME

FOR ENCLOSURES	ORDER SYMBOL	BANKS	MODULES
302017	MF 3020	2	12
403017	MF 4030	2	24
504023	MF 5040	3	54
604023	MF 6040	3	54
705027	MF 7050	4	88
806030	MF 8060	4	112
1008030	MF 10080	5	200

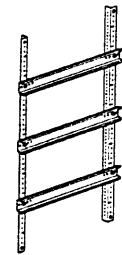

SWING DOOR KIT

ORDER SYMBOL	REMARKS
MB CAB	Set of 2 hinge supports for front plate

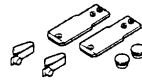

FASTENING LUGS

ORDER SYMBOL	REMARKS
MF CAB	Set of 4 fixing lugs, 304 stainless
TF CAB*	Set of 4 fixing lugs in polyamide

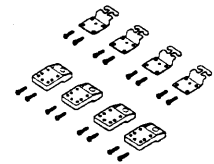

* Included in cabinets

FRONT PLATES

FOR ENCLOSURES	ORDER SYMBOL	OPENINGS
302017	FP 3020-2x6	2
403017	FP 4030-2x12	2
504023	FP 5040-3x18	3
604023	FP 6040-3x18	3
705027	FP 7050-4x22	4
806030	FP 8060-4x28	4
1008030	FP 10080-5x40	5

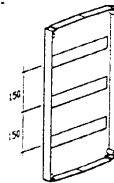

MOUNTING PLATES

ORDER SYMBOL	Metal	Perforated	Pertinax
MP 3020	MPP 3020	MPX 3020	
MP 4030	MPP 4030	MPX 4030	
MP 5040	MPP 5040	MPX 5040	
MP 6040	MPP 6040	MPX 6040	
MP 7050	MPP 7050	MPX 7050	
MP 8060	MPP 8060	MPX 8060	
MP 10080	MPP 10080	MPX 10080	

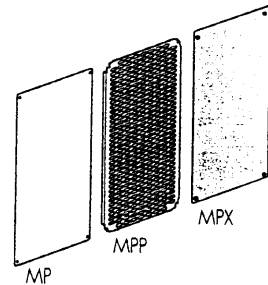

RAIL FOR TERMINAL BLOCKS

FOR ENCLOSURES	ORDER SYMBOL	AVAILABLE SPACES
302017	BR 20	2
403017	BR 30	3
504023	BR 40	4
604023	BR 40	4
705027	BR 50	6
806030	BR 60	7
1008030	BR 80	10

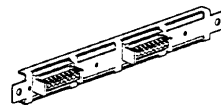

MOUNTING NUTS FOR MPP

ORDER SYMBOL	REMARKS
MB CAB M4	For perforated mounting plates
MB CAB M5	
MB CAB M6	



VENTILATION GRID (IP 44)

ORDER SYMBOL
MB VG CAB pair



TECHNICAL INFORMATION

GLASS FIBRE REINFORCED POLYESTER CABINET (GRP)

PROPERTY	GRB CABINET
Ingress protection	IP 65 (IEC 529, EN 60529)
Temperature range	- 50 °C - + 120°C Max. + 80 °C
Impact resistance	Excellent
Total insulation	☐
Standard colour	Grey (RAL 7032)
Standard gasket material	Polyurethane
Flame resistance	UL 94-V0, self-extinguishing
	Halogen free

CUSTOMIZATION

A Wide Selection Of Customized Enclosures At The Price Of Standard Enclosures.

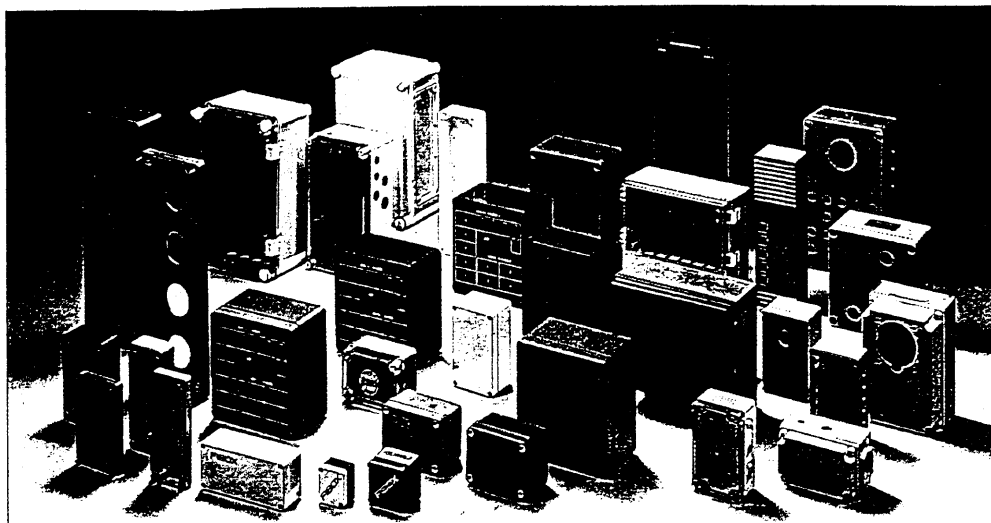

Fibox, a privately-owned Finnish company is one of the biggest enclosure manufacturers in the world and is the leader on the market in many European countries as well as outside Europe.

Whatever your application, the Fibox enclosure range includes high quality choices for the protection of electrical and electronics components. Enclosures are delivered to you according to your specifications ready for assembly.

Fibox Oy Ab has earned ISO 9001 quality certification for all its operations in 1992. The company's enclosures are NEMA/UL (type 4, 4X, 6, 12 and 13) and IEC IP 54 to 67 rated. In addition, three product lines are rated for use in hazardous areas.

CD-ROM ENCLOSURE CATALOGUE

The Fibox Enclosure Catalogue on CD-ROM (PC) gives you the fastest route for choosing products with appropriate accessories and making your purchase orders. With the help of enclosure drawings on the CD-ROM, it is easy to customize standard enclosures for your own application.



CUSTOMER SERVICE:

Fibox Suomi Oy
P O Box 4
FIN-02421 JORVAS, Finland
Tel. +358 9 2955 351
Fax +358 9 2955 3500

FIBOX AB
Enhagslingan 3
S-187 40 TABY, Sweden
Tel. +46 8 792 26 70
Fax +46 8 792 01 64

Fibox A/S
Rugvænget 30
DK-2630 Tåstrup, Denmark
Tel. +45 437 18055
Fax +45 437 18035

FIBOX FRANCE Sarl
1 rue Becquerel
ZI de Mitry-Compans
B.P. 553, F-77295 Mitry Mory, France
Tel.: +33-1-60 21 17 17
Fax: +33-1-60 21 17 18

Fibox GmbH
Böttgerstrasse 2-14
D-65439 Flörsheim am Main, Germany
Tel.: +49 6145 92 76-0
Fax: +49 6145 92 76-10

AJM Industry Ltd.
9L, 155B, Namdong Gongdan
726-8 Gojan-dong, Namdong-ku,
Inchon Republic of Korea
Tel: +82 32 81 46 742
Fax +82 32 81 46 077

Fibox Ltd
Unit 7, Stephenson Court
Skippers Lane, Middlesbrough
Teesside TS6 6UT, England
Tel. +44 1642 4666 59
Fax +44 1642 4666 69

Fibox Inc
Tech 100 Business Park
6675C Santa Barbara Rd.
Elkridge 21227, Maryland (MD) USA
Tel. +1 410 579 1999
Fax +1 410 796 3298

FIBOX

<http://www.fibox.fi>