



- products
- technical data
- quality
- environmental
- news
- about us
- contact us
- home

**ACCESSORIES**  
**Mounting Clips**

**DIMENSIONS (mm)**  
**Horizontal Mounting**

TYPE	CAN DIA	A	B	C	F
H1	25	40	22.3	12.8	10
H2	35	52	22.3	12.8	10

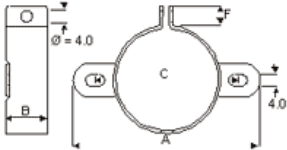
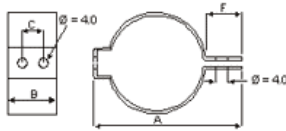

**Vertical Mounting**

TYPE	CAN DIA	A	B	C	F
V2	25	49	19	37	10
V3	35	58	19	45	9
V9	40	65	19	52.4	9.5

TYPE	CAN DIA	A	B	C	E	F
V4	51	75	25.4	64	5	10
V6	45	69.5	17.4	58	4	10
V8	63.5	88.9	25.4	77.5	5	9.5

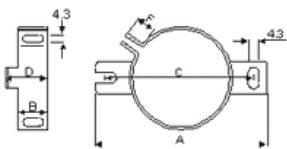
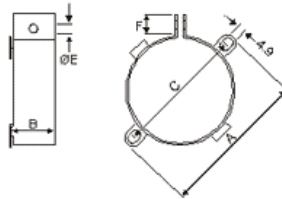

TYPE	CAN DIA	A	B	C	E	F
UTE2736	35	63	12.2	54	17.2	10

TYPE	CAN DIA	A	B	C	D	E	F
V10	65	90	40	30	5	4.5	-
V11	76	103	45.5	30	5	4.5	-
V90	90	116	53.5	30	5	4.5	-

UTE2737	50	75.5	33.5	27	4.3	4.3	39.5
UTE2738	65	88.5	39	27	4.3	4.3	45
UTE2739	72	97	44	28	4.3	4.3	50

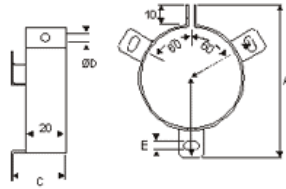

**Material**  
Zinc plated steel

**Note**  
When using mounting clamps care should be taken not to obscure any safety vent in the can.

**Stud Mounting Kits**

**INSULATED VERSION**  
M8 Stud (M12 Stud)

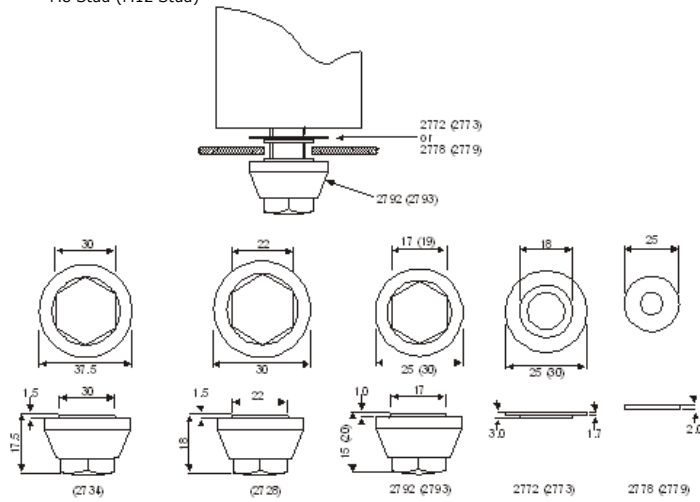

**NON-INSULATED VERSION**  
M8 Stud (M12 Stud)

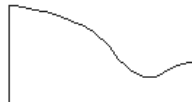

**Kit Contents and Ordering Information**

**STANDARD KITS**

Part code	Description	2740	2741	2782	2785
2352	Steel washer M8			●	
2353	Steel washer M12				●
2772	Stepped poly washer M8	●			
2773	Stepped poly washer M12		●		
2778	Plain poly washer M8	●			
2779	Plain poly washer M12		●		
2788	Steel nut M12				●
2789	Steel nut M8			●	
2792	Nylon nut M8	●			
2793	Nylon nut M12		●		
	Kit description	Ins M8	Ins M12	Non-ins M8	Non-ins M12

**SPECIAL KITS**

Part code	Description	2684	2685	2690	2691	2692	2693	2695
2352	Steel washer M8					●		
2353	Steel washer M12			●			●	
2772	Stepped poly washer M8	●			●	●		
2773	Stepped poly washer M12		●	●			●	●
2778	Plain poly washer M8				●	●		
2779	Plain poly washer M12						●	●
2788	Steel nut M12		●	●			●	●
2789	Steel nut M8	●			●	●		
2728	Nylon nut M12							
2734	Nylon nut M12							

