

5 Accessories

Sensor mounting clamps

Ø3, Ø4, Ø5, Ø6.5, Ø8

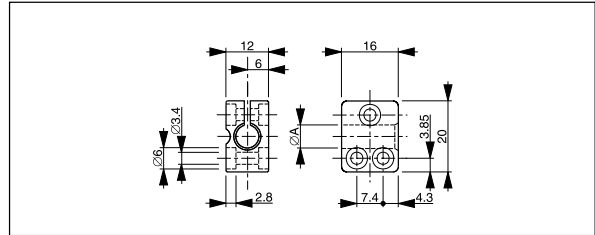

Technical data

Part reference	Type	A
ASU-0001-030	without limit stop	Ø 3 mm
ASU-0001-040	without limit stop	Ø 4 mm
ASU-0001-050	without limit stop	Ø 5 mm
ASU-0001-065	without limit stop	Ø 6.5 mm
ASU-0001-080	without limit stop	Ø 8 mm
ASU-0002-080	with limit stop	Ø 8 mm

Material: PA 6 black

Screw: DIN 912, M3 zinc-plated

Nut: DIN 934, M3 zinc-plated

Ø12, Ø18

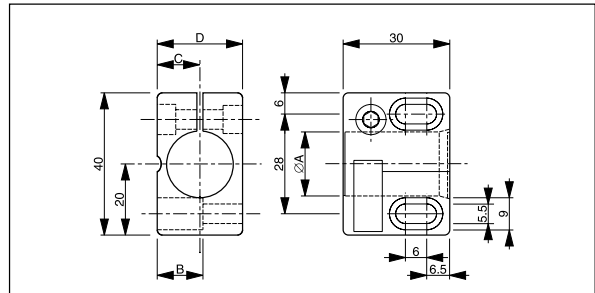

Technical data

Part reference	Type	A	B	C	D
ASU-0001-120	without limit stop	Ø 12 mm	9.75 mm	9 mm	18 mm
ASU-0002-120	with limit stop	Ø 12 mm	9.75 mm	9 mm	18 mm
ASU-0001-180	without limit stop	Ø 18 mm	12.85 mm	12 mm	24 mm
ASU-0002-180	with limit stop	Ø 18 mm	12.85 mm	12 mm	24 mm

Material: PA 6 GK (Ø 18 mm), PA 6 (Ø 12 mm) black

Screw: DIN 912, M5 zinc-plated

Nut: DIN 934, M5 zinc-plated

Ø30

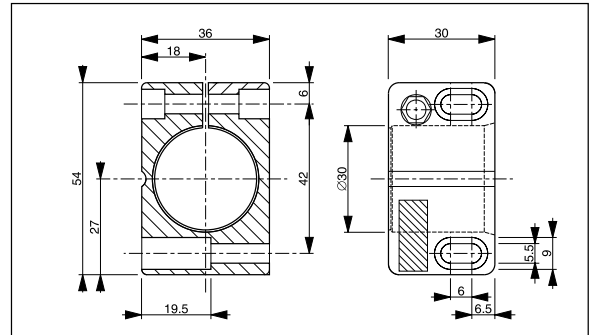

Technical data

Part reference	Type	
ASU-0001-300	without limit stop	Ø 30 mm
ASU-0002-300	with limit stop	Ø 30 mm

Material: PA 6 GK black

Screw: DIN 912, M5 x 25 zinc-plated

Nut: DIN 934, M5 zinc-plated

Bases for Ø12, Ø18

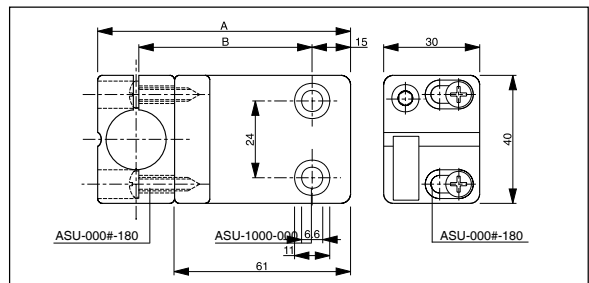

Technical data

Part reference	Type	A with Ø12 / Ø18	B with Ø12 / Ø18
ASU-1000-000	horizontal	79 mm / 85 mm	55 mm / 58 mm

Material: PA 6 black

Screw: DIN 7981, Ø 4.2 zinc-plated

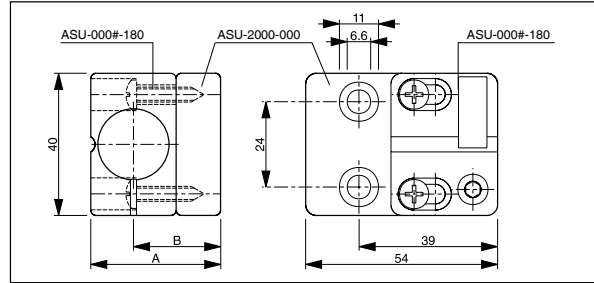

Technical data

Part reference	Type	A with Ø12 / Ø18	B with Ø12 / Ø18
ASU-2000-000	vertical	30.5 mm / 36.5 mm	21.5 mm / 24.5 mm

Material: PA 6 black

Screw: DIN 7981, Ø 4.2 zinc-plated

Sensor tester

ATE-0000-001

These devices are suitable for testing various sensor types: inductive, capacitive, photoelectric.



- Connection possibilities for PNP, NPN, Namur, and 2-wire DC devices, N.C. and N.O.
- LED and buzzer indicators
- Current supply from a single 9 V battery
- Built-in voltage transformer
- Built-in automatic time switch (switches off after approx. 60 secs)

Power supply unit, amplifiers

These devices are built into user-friendly clamping frames that can be snapped onto various standard rails, thanks to their universal foot.

Dimensions (all types):

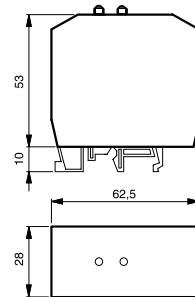

Power supply unit

DW-AZ-100-24

Supply voltage
Power drain
Output voltage
Output current

220 VAC
3 VA
24 VDC
100 mA max.

Wiring diagram:

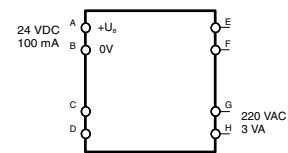

Amplifiers for 3-wire proximity switches

DW-AZ-100-A3

These devices are suitable for NPN and PNP N.O. proximity switches. Operating the switch activates the relay, and the contact closes. A wire bridge between B and D inverts this function.

Supply voltage	220 VAC
Power drain	0.5 VA
Output voltage	18.5 VDC
Output current	20 mA max.

Wiring diagram:

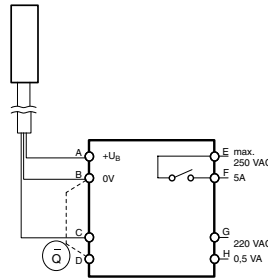

DW-AZ-100-D3

These devices are suitable for NPN and PNP N.O. proximity switches. Operating the switch activates the relay, and the contact closes. A wire bridge between B and D inverts this function.

Supply voltage	24 VDC
No-load supply current	20 mA max.
Output voltage	18.5 VDC
Output current	20 mA max.

Wiring diagram:

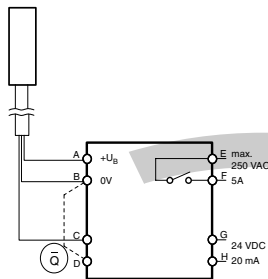

Amplifiers for NAMUR proximity switches

DW-AZ-100-AN

These devices are suitable for NAMUR proximity switches. Operating the switch activates the relay, and the contact closes. A wire bridge between C and D inverts this function.

Supply voltage	220 VAC
Power drain	0.5 VA

Output current and impedance correspond to NAMUR standard (DIN 19234).

Wiring diagram:

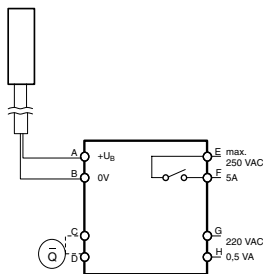

DW-AZ-100-DN

These devices are suitable for NAMUR proximity switches. Operating the switch activates the relay, and the contact closes. A wire bridge between C and D inverts this function.

Supply voltage	24 VDC
No-load supply current	20 mA max.

Output current and impedance correspond to NAMUR standard (DIN 19234).

Wiring diagram:

