

TK Empty enclosures IP 66

TK-Designation scheme

Material

PS = polystyrene

PC = polycarbonate

Cover material

T = transparent

n/a = grey

Height in cm

PS 1309-8-tm

Length x width in cm

m = metric

o = without pre-embossing

tv = with moulded cable gland

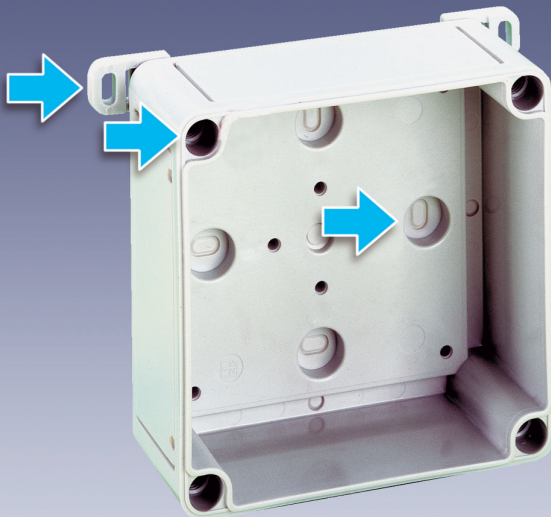

TK-empty enclosures

- IP 66
- Plastic: optional polystyrene or glass-fibre-reinforced polycarbonate
- shockproof
- temperature-resistant

- Individual choice of fixing
- 13 basic enclosures with up to 3 different cover heights
- extensive accessories
- Quality documented by quality marks and approvals

From development up to the manufacturing - from one source
Customers' individual enclosures are drawn in 2D or 3D and the first prototypes are manufactured in our own tool manufacture. If required, these enclosures will also be assembled or completely confectioned.

▲▲ Practical combinations
-next to each other or one above the other

Special solutions

- with UL-approval
- with ATEX-approval
- HF for EMC-application

Empty Enclosures

TK-PC 55
52 x 50 mm

IP 66



Description	Height	Order No.	Packing Qty
Empty enclosure, $U_i=690$ V, Box and cover: glass-fibre reinforced polycarbonate, grey, similar to RAL 7035			
PC 55-4-m	35 mm	127 455 01	60/5
PC 55-4-v	35 mm	129 455 01	60/5
PC 55-4-o	35 mm	120 455 01	60/5

TK-PC 55
52 x 50 mm

IP 66



Description	Height	Order No.	Packing Qty
Empty enclosure, $U_i=690$ V, Box: glass-fibre reinforced polycarbonate, grey, similar to RAL 7035, Cover: Polycarbonate, transparent			
PC 55-4-tm	35 mm	137 455 01	60/5
PC 55-4-tv	35 mm	139 455 01	60/5
PC 55-4-to	35 mm	130 455 01	60/5

TK-PC 75
65 x 50 mm

IP 66



Description	Height	Order No.	Packing Qty
Empty enclosure, $U_i=690$ V, Box and cover: glass-fibre reinforced polycarbonate, grey, similar to RAL 7035			
PC 75-4-m	35 mm	127 475 01	45/5
PC 75-4-v	35 mm	129 475 01	45/5
PC 75-4-o	35 mm	120 475 01	45/5

TK-PC 75
65 x 50 mm

IP 66



Description	Height	Order No.	Packing Qty
Empty enclosure, $U_i=690$ V, Box: glass-fibre reinforced polycarbonate, grey, similar to RAL 7035, Cover: Polycarbonate, transparent			
PC 75-4-tm	35 mm	137 475 01	45/5
PC 75-4-tv	35 mm	139 475 01	45/5
PC 75-4-to	35 mm	130 475 01	45/5

TK-PS 77
65 x 65 mm

IP 66



Description	Height	Order No.	Packing Qty
Empty enclosure, $U_i=690$ V, Box and cover: polystyrene, grey, similar to RAL 7035			
PS 77-6-m	57 mm	105 401 01	40/5
PS 77-8-m	81 mm	105 901 01	45/5
PS 77-6-o	57 mm	110 401 01	40/5
PS 77-8-o	81 mm	110 901 01	45/5

TK-PS 77
65 x 65 mm

IP 66



Description	Height	Order No.	Packing Qty
Empty enclosure, $U_i=690$ V, Box: polystyrene, grey, similar to RAL 7035, Cover: Polycarbonate, transparent			
PS 77-6-tm	57 mm	106 001 01	40/5
PS 77-8-tm	81 mm	106 501 01	45/5
PS 77-6-to	57 mm	111 001 01	40/5
PS 77-8-to	81 mm	111 501 01	45/5

TK-PC 77
65 x 65 mm

IP 66



Description	Height	Order No.	Packing Qty
Empty enclosure, $U_i=690$ V, Box and cover: glass-fibre reinforced polycarbonate, grey, similar to RAL 7035			
PC 77-6-m	57 mm	127 401 01	40/5
PC 77-8-m	81 mm	127 901 01	45/5

TK-PC 77
65 x 65 mm

IP 66



Description	Height	Order No.	Packing Qty
Empty enclosure, $U_i=690$ V, Box: glass-fibre reinforced polycarbonate, grey, similar to RAL 7035, Cover: Polycarbonate, transparent			
PC 77-6-tm	57 mm	137 001 01	40/5
PC 77-8-tm	81 mm	137 501 01	45/5

TK-PS 97
94 x 65 mm

IP 66



Description	Height	Order No.	Packing Qty
Empty enclosure, $U_i=690$ V, Box and cover: polystyrene, grey, similar to RAL 7035			
PS 97-6-m	57 mm	105 402 01	25/5
PS 97-8-m	81 mm	105 902 01	15/5
PS 97-6-o	57 mm	110 402 01	25/5
PS 97-8-o	81 mm	110 902 01	15/5

TK-PS 97
94 x 65 mm

IP 66



Description	Height	Order No.	Packing Qty
Empty enclosure, $U_i=690$ V, Box: polystyrene, grey, similar to RAL 7035, Cover: Polycarbonate, transparent			
PS 97-6-tm	57 mm	106 002 01	25/5
PS 97-8-tm	81 mm	106 502 01	15/5
PS 97-6-to	57 mm	111 002 01	25/5
PS 97-8-to	81 mm	111 502 01	15/5

TK-PC 97
94 x 65 mm

IP 66



Description	Height	Order No.	Packing Qty
Empty enclosure, $U_i=690$ V, Box and cover: glass-fibre reinforced, polycarbonate, grey, similar to RAL 7035			
PC 97-6-m	57 mm	127 402 01	25/5
PC 97-8-m	81 mm	127 902 01	15/5

TK-PC 97
94 x 65 mm

IP 66



Description	Height	Order No.	Packing Qty
Empty enclosure, $U_i=690$ V, Box: glass-fibre reinforced polycarbonate, grey, similar to RAL 7035, Cover: Polycarbonate, transparent			
PC 97-6-tm	57 mm	137 002 01	25/5
PC 97-8-tm	81 mm	137 502 01	15/5

TK-PS 99

94 x 94 mm

IP 66



Description

Height

Order No.

Packing Qty

Empty enclosure, $U_i=690$ V,
Box and cover: polystyrene, grey, similar to RAL 7035

Product Code	Height	Order No.	Packing Qty
PS 99-6-m	57 mm	105 403 01	40/4
PS 99-8-m	81 mm	105 903 01	30/3
PS 99-6-o	57 mm	110 403 01	40/4
PS 99-8-o	81 mm	110 903 01	30/3

TK-PS 99

94 x 94 mm

IP 66



Empty enclosure, $U_i=690$ V,
Box: polystyrene, grey, similar to RAL 7035,
Cover: Polycarbonate, transparent

Product Code	Height	Order No.	Packing Qty
PS 99-6-tm	57 mm	106 003 01	40/4
PS 99-8-tm	81 mm	106 503 01	30/3
PS 99-6-to	57 mm	111 003 01	40/4
PS 99-8-to	81 mm	111 503 01	30/3

TK-PC 99

94 x 94 mm

IP 66



Empty enclosure, $U_i=690$ V,
Box and cover: glass-fibre reinforced polycarbonate, grey, similar to RAL 7035

Product Code	Height	Order No.	Packing Qty
PC 99-6-m	57 mm	127 403 01	40/4
PC 99-8-m	81 mm	127 903 01	30/3

TK-PC 99

94 x 94 mm

IP 66



Empty enclosure, $U_i=690$ V,
Box: glass-fibre reinforced polycarbonate, grey, similar to RAL 7035,
Cover: Polycarbonate, transparent

Product Code	Height	Order No.	Packing Qty
PC 99-6-tm	57 mm	137 003 01	40/4
PC 99-8-tm	81 mm	137 503 01	30/3

TK-PS 1111
110 x 110 mm

IP 66



Description Empty enclosure, $U_i=690$ V,
Box and cover: polystyrene, grey, similar to RAL 7035

	Height	Order No.	Packing Qty
PS 1111-7-m	66 mm	105 404 01	21/3
PS 1111-9-m	90 mm	105 904 01	12/3
PS 1111-7-o	66 mm	110 404 01	21/3
PS 1111-9-o	90 mm	110 904 01	12/3

TK-PS 1111
110 x 110 mm

IP 66



Empty enclosure, $U_i=690$ V,
Box: glass-fibre reinforced polycarbonate, grey, similar to RAL 7035,
Cover: Polycarbonate, transparent

	Height	Order No.	Packing Qty
PS 1111-7-tm	66 mm	106 004 01	21/3
PS 1111-9-tm	90 mm	106 504 01	12/3
PS 1111-7-to	66 mm	111 004 01	21/3
PS 1111-9-to	90 mm	111 504 01	12/3

TK-PC 1111
110 x 110 mm

IP 66



Empty enclosure, $U_i=690$ V,,
Box and cover: glass-fibre reinforced polycarbonate, grey, similar to RAL 7035

	Height	Order No.	Packing Qty
PC 1111-7-m	66 mm	127 404 01	21/3
PC 1111-9-m	90 mm	127 904 01	12/3

TK-PC 1111
110 x 110 mm

IP 66



Empty enclosure, $U_i=690$ V,
Box: polystyrene, grey, similar to RAL 7035,
Cover: Polycarbonate, transparent

	Height	Order No.	Packing Qty
PC 1111-7-tm	66 mm	137 004 01	21/3
PC 1111-9-tm	90 mm	137 504 01	12/3

TK-PS 1309
130 x 94 mm

IP 66

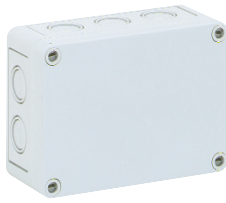

Description	Height	Order No.	Packing Qty
IP 66 Empty enclosure, $U_i=690$ V,, Box and cover: polystyrene, grey, similar to RAL 7035			

PS 1309-6-m	57 mm	105 409 01	30/3
PS 1309-8-m	81 mm	105 909 01	21/3
PS 1309-6-o	57 mm	110 409 01	30/3
PS 1309-8-o	81 mm	110 909 01	21/3

TK-PS 1309
130 x 94 mm

IP 66

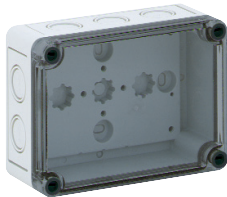

Empty enclosure, $U_i=690$ V, Box: polystyrene, grey, similar to RAL 7035, Cover: Polycarbonate, transparent			
--	--	--	--

PS 1309-6-tm	57 mm	106 009 01	30/3
PS 1309-8-tm	81 mm	106 509 01	21/3
PS 1309-6-to	57 mm	111 009 01	30/3
PS 1309-8-to	81 mm	111 509 01	21/3

TK-PC 1309
130 x 94 mm

IP 66



Empty enclosure, $U_i=690$ V,, Box and cover: glass-fibre reinforced polycarbonate, grey, similar to RAL 7035			
--	--	--	--

PC 1309-6-m	57 mm	127 409 01	30/3
PC 1309-8-m	81 mm	127 909 01	21/3

TK-PC 1309
130 x 94 mm

IP 66



Empty enclosure, $U_i=690$ V, Box: glass-fibre reinforced polycarbonate, grey, similar to RAL 7035, Cover: Polycarbonate, transparent			
---	--	--	--

PC 1309-6-tm	57 mm	137 009 01	30/3
PC 1309-8-tm	81 mm	137 509 01	21/3

Empty Enclosures

TK-PS 1313
130 x 130 mm

IP 66



Description	Height	Order No.	Packing Qty
-------------	--------	-----------	-------------

Empty enclosure, $U_i=690$ V,
Box and cover: polystyrene, grey, similar to RAL 7035

PS 1313-7-m	75 mm	105 405 01	14/2
PS 1313-10-m	99 mm	105 905 01	8/2
PS 1313-7-o	75 mm	110 405 01	14/2
PS 1313-10-o	99 mm	110 905 01	8/2

TK-PS 1313
130 x 130 mm

IP 66



Empty enclosure, $U_i=690$ V,
Box: polystyrene, grey, similar to RAL 7035,
Cover: Polycarbonate, transparent

PS 1313-7-tm	75 mm	106 005 01	14/2
PS 1313-10-tm	99 mm	106 505 01	8/2
PS 1313-7-to	75 mm	111 005 01	14/2
PS 1313-10-to	99 mm	111 505 01	8/2

TK-PC 1313
130 x 130 mm

IP 66



Empty enclosure, $U_i=690$ V,
Box and cover: glass-fibre reinforced polycarbonate, grey, similar to RAL 7035

PC 1313-7-m	75 mm	127 405 01	14/2
PC 1313-10-m	99 mm	127 905 01	8/2

TK-PC 1313
130 x 130 mm

IP 66



Empty enclosure, $U_i=690$ V,
Box: glass-fibre reinforced polycarbonate, grey, similar to RAL 7035,
Cover: Polycarbonate, transparent

PC 1313-7-tm	75 mm	137 005 01	14/2
PC 1313-10-tm	99 mm	137 505 01	8/2

TK-PS 1809
180 x 94 mm

IP 66



Description	Height	Order No.	Packing Qty
Empty enclosure, $U_i=690$ V, Box and cover: polystyrene, grey, similar to RAL 7035			
PS 1809-6-m	57 mm	105 410 01	20/2
PS 1809-8-m	81 mm	105 910 01	14/2
PS 1809-6-o	57 mm	110 410 01	20/2
PS 1809-8-o	81 mm	110 910 01	14/2

TK-PS 1809
180 x 94 mm

IP 66



Description	Height	Order No.	Packing Qty
Empty enclosure, $U_i=690$ V, Box: polystyrene, grey, similar to RAL 7035, Cover: Polycarbonate, transparent			
PS 1809-6-tm	57 mm	106 010 01	20/2
PS 1809-8-tm	81 mm	106 510 01	14/2
PS 1809-6-to	57 mm	111 010 01	20/2
PS 1809-8-to	81 mm	111 510 01	14/2

TK-PC 1809
180 x 94 mm

IP 66



Description	Height	Order No.	Packing Qty
Empty enclosure, $U_i=690$ V, Box and cover: glass-fibre reinforced polycarbonate, grey, similar to RAL 7035			
PC 1809-6-m	57 mm	127 410 01	20/2
PC 1809-8-m	81 mm	127 910 01	14/2

TK-PC 1809
180 x 94 mm

IP 66



Description	Height	Order No.	Packing Qty
Empty enclosure, $U_i=690$ V, Box: glass-fibre reinforced polycarbonate, grey, similar to RAL 7035, Cover: Polycarbonate, transparent			
PC 1809-6-tm	57 mm	137 010 01	20/2
PC 1809-8-tm	81 mm	137 510 01	14/2

TK-PS 1811
180 x 110 mm

IP 66



Description	Height	Order No.	Packing Qty
-------------	--------	-----------	-------------

Empty enclosure, $U_i=690$ V,
Box and cover: polystyrene, grey, similar to RAL 7035

PS 1811-9-m	90 mm	105 406 01	16/2
PS 1811-11-m	111 mm	105 906 01	12/2
PS 1811-16-m	165 mm	104 406 01	8/2
PS 1811-9-o	90 mm	110 406 01	16/2
PS 1811-11-o	111 mm	110 906 01	12/2
PS 1811-16-o	165 mm	109 406 01	8/2

TK-PS 1811
180 x 110 mm

IP 66



Empty enclosure, $U_i=690$ V,
Box: polystyrene, grey, similar to RAL 7035,
Cover: Polycarbonate, transparent

PS 1811-9-tm	90 mm	106 006 01	16/2
PS 1811-11-tm	111 mm	106 506 01	12/2
PS 1811-16-tm	165 mm	107 006 01	8/2
PS 1811-9-to	90 mm	111 006 01	16/2
PS 1811-11-to	111 mm	111 506 01	12/2
PS 1811-16-to	165 mm	112 006 01	8/2

TK-PC 1811
180 x 110 mm

IP 66



Empty enclosure, $U_i=690$ V,,
Box and cover: glass-fibre reinforced, polycarbonate, grey, similar to RAL 7035

PC 1811-9-m	90 mm	127 406 01	16/2
PC 1811-11-m	111 mm	127 906 01	12/2
PC 1811-16-m	165 mm	128 406 01	8/2

TK-PC 1811
180 x 110 mm

IP 66



Empty enclosure, $U_i=690$ V,
Box: glass-fibre reinforced polycarbonate, grey, similar to RAL 7035,
Cover: Polycarbonate, transparent

PC 1811-9-tm	90 mm	137 006 01	16/2
PC 1811-11-tm	111 mm	137 506 01	12/2
PC 1811-16-tm	165 mm	138 006 01	8/2

TK-PS 1818
182 x 180 mm

IP 66



Description	Height	Order No.	Packing Qty
IP 66 Empty enclosure, $U_i=690$ V, Box and cover: glass-fibre reinforced polycarbonate, grey, similar to RAL 7035			
PS 1818-9-m	90 mm	105 407 01	8/2
PS 1818-11-m	111 mm	105 907 01	8/2
PS 1818-16-m	165 mm	104 407 01	4/1
PS 1818-9-o	90 mm	110 407 01	8/2
PS 1818-11-o	111 mm	110 907 01	8/2
PS 1818-16-o	165 mm	109 407 01	4/1

TK-PS 1818
182 x 180 mm

IP 66



Description	Height	Order No.	Packing Qty
Empty enclosure, $U_i=690$ V, Box: polystyrene, grey, similar to RAL 7035, Cover: Polycarbonate, transparent			
PS 1818-9-tm	90 mm	106 007 01	8/2
PS 1818-11-tm	111 mm	106 507 01	8/2
PS 1818-16-tm	165 mm	107 007 01	4/1
PS 1818-9-to	90 mm	111 007 01	8/2
PS 1818-11-to	111 mm	111 507 01	8/2
PS 1818-16-to	165 mm	112 007 01	4/1

TK-PC 1818
182 x 180 mm

IP 66



Description	Height	Order No.	Packing Qty
Empty enclosure, $U_i=690$ V, Box and cover: polystyrene, grey, similar to RAL 7035			
PC 1818-9-m	90 mm	127 407 01	8/2
PC 1818-11-m	111 mm	127 907 01	8/2
PC 1818-16-m	165 mm	128 407 01	4/1

TK-PC 1818
182 x 180 mm

IP 66



Description	Height	Order No.	Packing Qty
Empty enclosure, $U_i=690$ V, Box: glass-fibre reinforced polycarbonate, grey, similar to RAL 7035, Cover: Polycarbonate, transparent			
PC 1818-9-tm	90 mm	137 007 01	8/2
PC 1818-11-tm	111 mm	137 507 01	8/2
PC 1818-16-tm	165 mm	138 007 01	4/1

TK-PS 1818 flat
182 x 180 mm

IP 66



NEW!

Description Empty enclosure, $U_i=690$ V,
Box and cover: polystyrene, grey, similar to RAL 7035

	Height	Order No.	Packing Qty
PS 1818-6f-m	63 mm	105 413 01	8/2
PS 1818-8f-m	84 mm	105 913 01	8/2
PS 1818-13f-m	137 mm	104 413 01	4/1
PS 1818-6f-o	63 mm	110 413 01	8/2
PS 1818-8f-o	84 mm	110 913 01	8/2
PS 1818-13f-o	137 mm	109 413 01	4/1

TK-PS 1818 flat
182 x 180 mm

IP 66



NEW!

Description Empty enclosure, $U_i=690$ V,
Box: polystyrene, grey, similar to RAL 7035
Cover: Polycarbonate, transparent

	Height	Order No.	Packing Qty
PS 1818-6f-tm	63 mm	106 013 01	8/2
PS 1818-8f-tm	84 mm	106 513 01	8/2
PS 1818-13f-tm	137 mm	107 013 01	4/1
PS 1818-6f-to	63 mm	111 013 01	8/2
PS 1818-8f-to	84 mm	111 513 01	8/2
PS 1818-13f-to	137 mm	112 013 01	4/1

TK-PC 1818 flat
182 x 180 mm

IP 66



NEW!

Description Empty enclosure, $U_i=690$ V,
Box and cover: glass-fibre reinforced polycarbonate, grey, similar to RAL 7035,

	Height	Order No.	Packing Qty
PC 1818-6f-m	63 mm	127 413 01	8/2
PC 1818-8f-m	84 mm	127 913 01	8/2
PC 1818-13f-m	137 mm	128 413 01	4/1

TK-PC 1818 flat
182 x 180 mm

IP 66



NEW!

Description Empty enclosure, $U_i=690$ V,,
Box: polystyrene, grey, similar to RAL 7035
Cover: Polycarbonate, transparent

	Height	Order No.	Packing Qty
PC 1818-6f-tm	63 mm	137 013 01	8/2
PC 1818-8f-tm	84 mm	137 513 01	8/2
PC 1818-13f-tm	137 mm	138 013 01	4/1

TK-PS 2518
254 x 180 mm

IP 66



Description	Height	Order No.	Packing Qty
Empty enclosure, $U_i=690$ V, Box and cover: polystyrene, grey, similar to RAL 7035			
PS 2518-9-m	90 mm	105 408 01	8/1
PS 2518-11-m	111 mm	105 908 01	6/1
PS 2518-16-m	165 mm	104 408 01	4/1
PS 2518-9-o	90 mm	110 408 01	8/1
PS 2518-11-o	111 mm	110 908 01	6/1
PS 2518-16-o	165 mm	109 408 01	4/1

TK-PS 2518
254 x 180 mm

IP 66



Description	Height	Order No.	Packing Qty
Empty enclosure, $U_i=690$ V, Box: polystyrene, grey, similar to RAL 7035, Cover: Polycarbonate, transparent			
PS 2518-9-tm	90 mm	106 008 01	8/1
PS 2518-11-tm	111 mm	106 508 01	6/1
PS 2518-16-tm	165 mm	107 008 01	4/1
PS 2518-9-to	90 mm	111 008 01	8/1
PS 2518-11-to	111 mm	111 508 01	6/1
PS 2518-16-to	165 mm	112 008 01	4/1

TK-PC 2518
254 x 180 mm

IP 66



Description	Height	Order No.	Packing Qty
Empty enclosure, $U_i=690$ V, Box and cover: glass-fibre reinforced polycarbonate, grey, similar to RAL 7035			
PC 2518-9-m	90 mm	127 408 01	8/1
PC 2518-11-m	111 mm	127 908 01	6/1
PC 2518-16-m	165 mm	128 408 01	4/1

TK-PC 2518
254 x 180 mm

IP 66



Description	Height	Order No.	Packing Qty
Empty enclosure, $U_i=690$ V, Box: glass-fibre reinforced polycarbonate, grey, similar to RAL 7035, Cover: Polycarbonate, transparent			
PC 2518-9-tm	90 mm	137 008 01	8/1
PC 2518-11-tm	111 mm	137 508 01	6/1
PC 2518-16-tm	165 mm	138 008 01	4/1

TK-PS 2518 flat

254 x 180 mm

IP 66



NEW!

Description
Empty enclosure, $U_i=690\text{ V}$,
Box and cover: polystyrene, grey, similar to RAL 7035

	Height	Order No.	Packing Qty
PS 2518-6f-m	63 mm	105 411 01	8/1
PS 2518-8f-m	84 mm	105 911 01	6/1
PS 2518-13f-m	137 mm	104 411 01	4/1
PS 2518-6f-o	63 mm	110 411 01	8/1
PS 2518-8f-o	84 mm	110 911 01	6/1
PS 2518-13f-o	137 mm	109 411 01	1/4

TK-PS 2518 flat

254 x 180 x 63 mm,

IP 66



NEW!

Description
Empty enclosure, $U_i=690\text{ V}$,
Box: polystyrene, grey, similar to RAL 7035,
Cover: Polycarbonate, transparent

	Height	Order No.	Packing Qty
PS 2518-6f-tm	63 mm	106 011 01	8/1
PS 2518-8f-tm	84 mm	106 511 01	6/1
PS 2518-13f-tm	137 mm	107 011 01	4/1
PS 2518-6f-to	63 mm	111 011 01	8/1
PS 2518-8f-to	84 mm	111 511 01	6/1
PS 2518-13f-to	137 mm	112 011 01	4/1

TK-PC 2518 flat

254 x 180 mm

IP 66



NEW!

Description
Empty enclosure, $U_i=690\text{ V}$,
Box and cover: glass-fibre reinforced polycarbonate, grey, similar to RAL 7035

	Height	Order No.	Packing Qty
PC 2518-6f-m	63 mm	127 411 01	8/1
PC 2518-8f-m	84 mm	127 911 01	6/1
PC 2518-13f-m	137 mm	128 411 01	4/1

TK-PC 2518 flat

254 x 180 mm

IP 66



NEW!

Description
Empty enclosure, $U_i=690\text{ V}$,
Box: glass-fibre reinforced polycarbonate, grey, similar to RAL 7035,
Cover: Polycarbonate, transparent

	Height	Order No.	Packing Qty
PC 2518-6f-tm	63 mm	137 011 01	8/1
PC 2518-8f-tm	84 mm	137 511 01	6/1
PC 2518-13f-tm	137 mm	138 011 01	4/1

TK-PS 3625
360 x 254 mm

IP 66



Description	Height	Order No.	Packing Qty
Empty enclosure, $U_i=690$ V, Box and cover: polystyrene, grey, similar to RAL 7035			
PS 3625-11-m	111 mm	105 412 01	3/1
PS 3625-16-m	165 mm	105 912 01	2/1
PS 3625-11-o	111 mm	110 412 01	3/1
PS 3625-16-o	165 mm	110 912 01	2/1

TK-PS 3625
360 x 254 mm

IP 66



Description	Height	Order No.	Packing Qty
Empty enclosure, $U_i=690$ V, Box: polystyrene, grey, similar to RAL 7035, Cover: Polycarbonate, transparent			
PS 3625-11-tm	111 mm	106 012 01	3/1
PS 3625-16-tm	165 mm	106 512 01	2/1
PS 3625-11-to	111 mm	111 012 01	3/1
PS 3625-16-to	165 mm	111 512 01	2/1

TK-PC 3625
360 x 254 mm

IP 66



Description	Height	Order No.	Packing Qty
Empty enclosure, $U_i=690$ V, Box and cover: glass-fibre reinforced polycarbonate, grey, similar to RAL 7035			
PC 3625-11-m	111 mm	127 412 01	3/1
PC 3625-16-m	165 mm	127 912 01	2/1

TK-PC 3625
360 x 254 mm

IP 66



Description	Height	Order No.	Packing Qty
Empty enclosure, $U_i=690$ V, Box: glass-fibre reinforced polycarbonate, grey, similar to RAL 7035 Cover: Polycarbonate, transparent			
PC 3625-11-tm	111 mm	137 012 01	3/1
PC 3625-16-tm	165 mm	137 512 01	2/1

Assembly plates

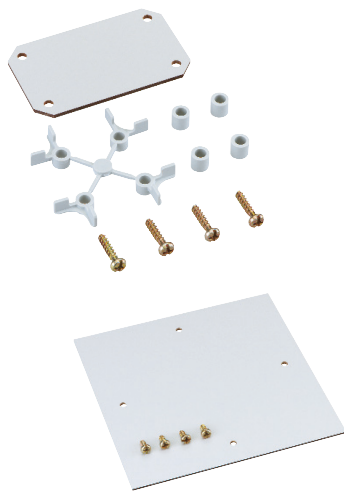

Description

Order No.

Packing Qty

with support for the assembly plate for the assembly without tools.
1 kit = 5 assembly plates

TK MPI-55	6 x 44 x 2,0 mm	TK 55	195 055 01	200/1
TK MPI-75	59 x 44 x 2,0 mm	TK 75	195 075 01	200/1

Assembly plate made of insulating material, including fixing screws and spacers

TK MPI-77	45 x 45 x 2,5 mm	TK 77	195 001 01	200/1
TK MPI-97	74 x 45 x 2,5 mm	TK 97	195 002 01	250/1
TK MPI-99	74 x 74 x 2,5 mm	TK 99	195 003 01	175/1
TK MPI-1111	90 x 90 x 2,5 mm	TK 1111	195 004 01	150/1
TK MPI-1309	110 x 74 x 2,5 mm	TK 1309	195 009 01	150/1
TK MPI-1313	110 x 110 x 2,5 mm	TK 1313	195 005 01	125/1
TK MPI-1809	160 x 74 x 2,5 mm	TK 1809	195 010 01	150/1
TK MPI-1811	150 x 90 x 2,5 mm	TK 1811	195 006 01	250/1
TK MPI-1818	150 x 150 x 2,5 mm	TK 1818	195 007 01	125/1
TK MPI-2518	220 x 150 x 2,5 mm	TK 2518	195 008 01	100/1
TK MPI-3525	331 x 220 x 2,5 mm	TK 3625	195 012 01	50/1

Standard rails TS 15

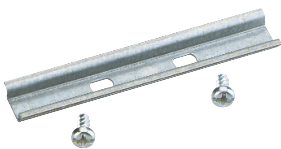

Standard rail DIN EN 50 045-15 x 5. 15 mm wide, including fixing screws

Type / Length	Enclosure type		
TK TS15-49,5	TK 77/97	197 049 01	1/1
TK TS15-80	TK 97/99/1111/1309/1313/1809/1811	197 080 01	1/1
TK TS15-92	TK 1111/1309/1313/1811	197 092 01	1/1
TK TS15-111	TK 1309/1313	197 111 01	1/1
TK TS15-154	TK 1809/1811/1818/2518	197 154 01	1/1

Standard rails NS 35

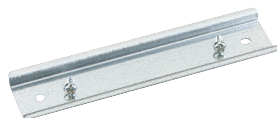

Standard rail DIN EN 50,022-35 x 7.5. 35 mm wide, including fixing screws

Type / Length	Enclosure type		
TK NS35-81	TK 1111/1309/1313/1809/1811	198 081 01	1/1
TK NS35-106	TK 1309/1313	198 106 01	1/1
TK NS35-144	TK 1809/11/18/2518	198 144 01	1/1
TK NS35-216	TK 2518/3625	198 216 01	1/1
TK NS35-336	TK 3625	198 336 01	1/1

External hinge set



for converting the enclosure cover to a hinged door.
Including 2 hinges, fixing screws, cover plugs and drilling template

ASS-kl , external hinge set small	190 002 01	200/1
ASS-gro , external hinge set large, from TK 1811	190 005 01	10/1

Combi-set

IP 66

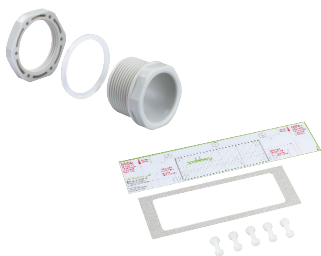

Combi set, protection class IP 66, for side connection of enclosures with metric entries, complete with lock nuts and intermediate wall seal inserts

KS M20	192 020 01	1/1
KS M25	192 025 01	1/1
KS M32	192 032 01	1/1
KS gro from TK 1811	192 018 01	1/1

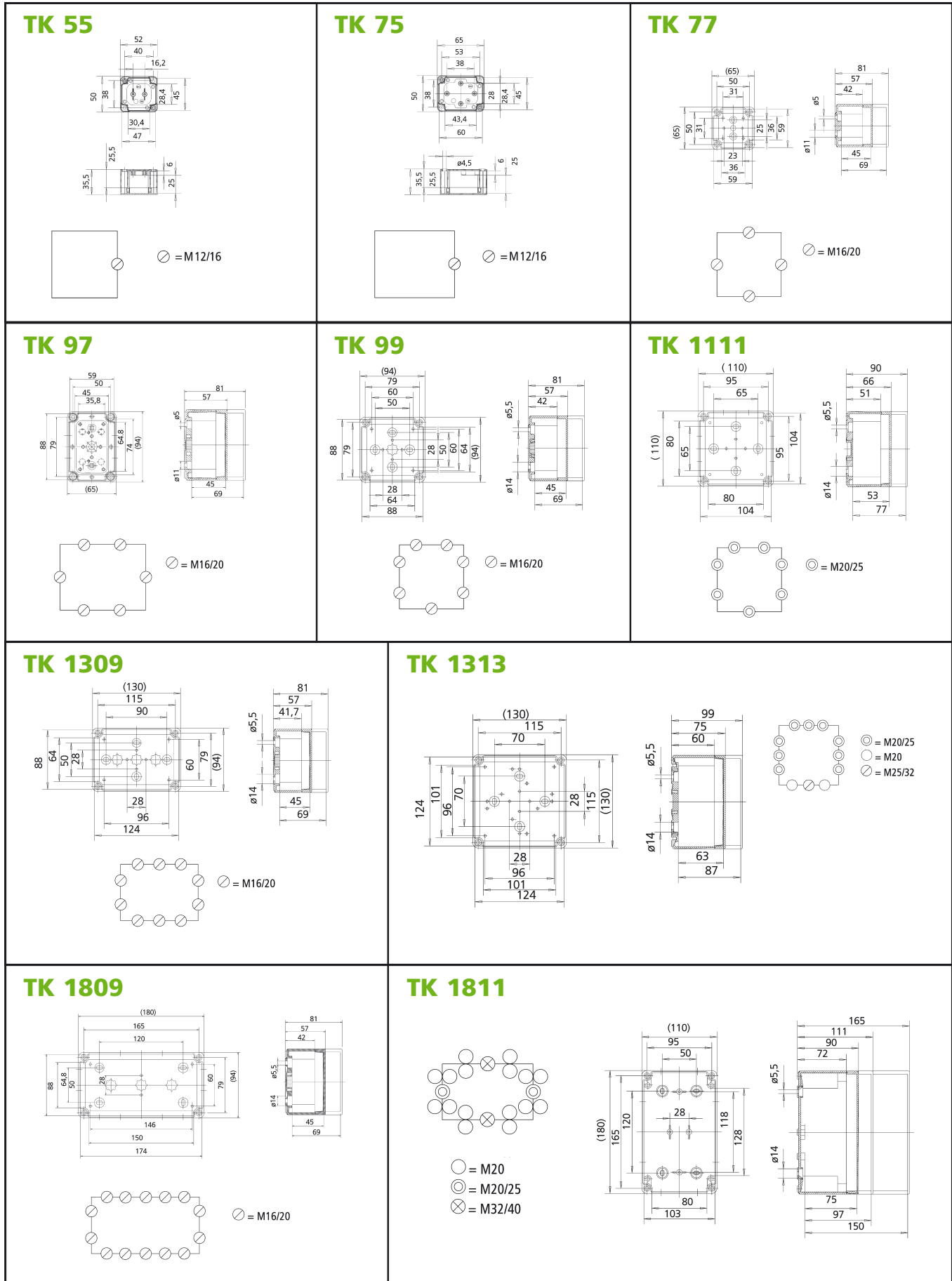

TK 1818

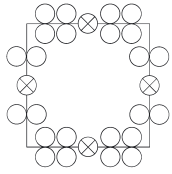

- = M 20
- ⊗ = M 32/40

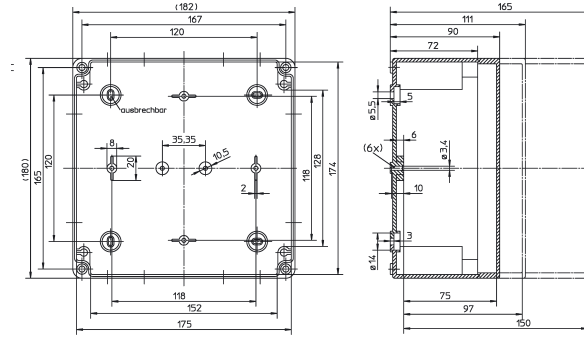

TK 1818-f

New!

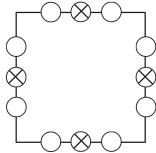

- = M 16/20
- ⊗ = M 25/32

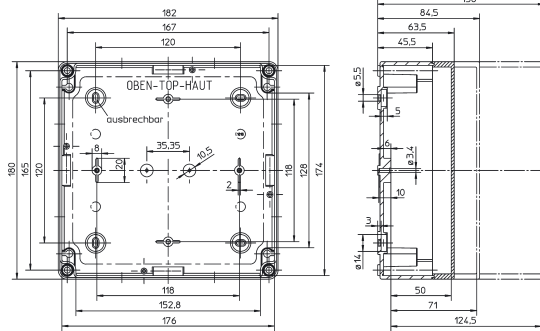

TK 2518

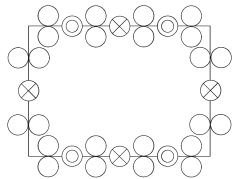

- = M 20
- ⊗ = M 25/32
- ⊗ = M 32/40

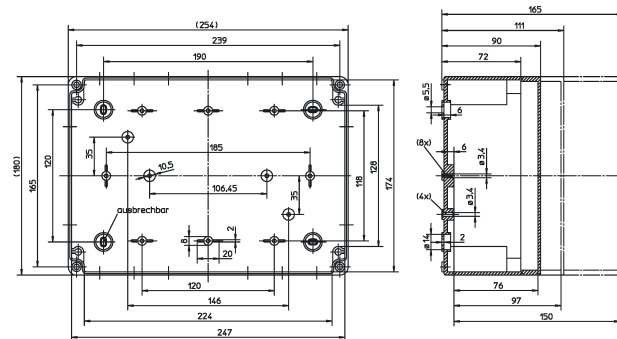

TK 2518-f

New!

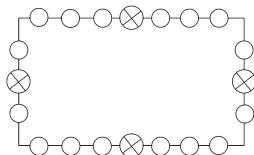

- = M 16/20
- ⊗ = M 25/32

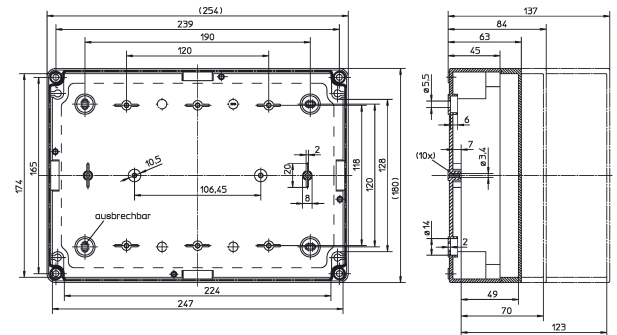

TK 3625

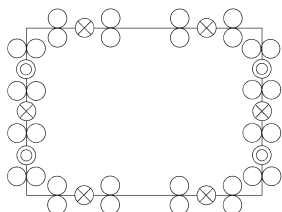

- = M 20
- ⊗ = M 25/32
- ⊗ = M 32/40

