

Optimal IV Star Series

Mono-Color, Multi-LED

OV4Zxxxx

- Designed for 4 1-watt chips in recessed cavity with an optical grade 5mm diameter lens
- Exceptional thermal resistance (1.8°C/W junction to heatsink)
- Solder Pads Au Plated

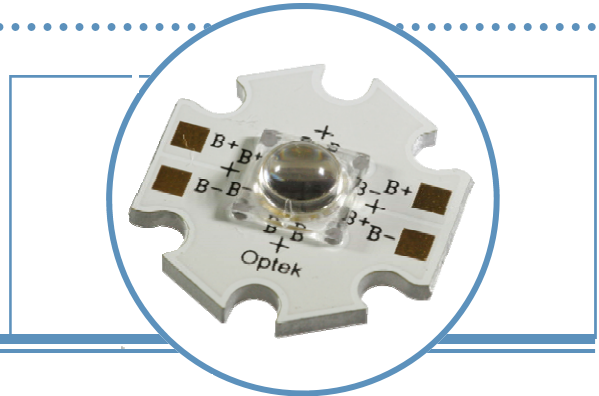

Part Number	Viewing Angle	Emitted Color	Typical Luminous Flux (lm)		Forward Voltage (V _F)	
			350 mA	700 mA	350 mA	700 mA
OV4ZBBBB	60°	Blue 455-460nm	29	49	12.6	14.2
OV4ZGGGG		Green 530-535nm	173	272	13.1	14.6
OV4ZRRRR		Red 620-630nm	102	183	8.7	9.55
OV4ZAAAA		Amber 585-595nm	109	170	8.6	9.35
OV4ZWD		Daylight White	162	273	12.6	14.2

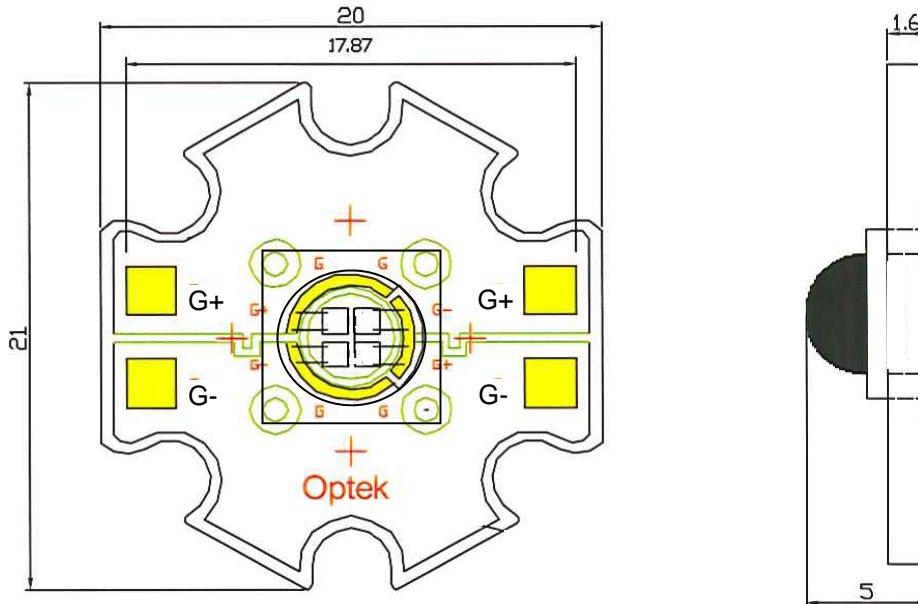

Notes:

- Test conditions: I_F=350 mA / 700 mA; T_J @ 25°C
- Polarity Pads opposite for Red / Amber vs. Blue / Green / White
- All dimensions are in millimeters.
- Additional heat sinking required.



DO NOT LOOK DIRECTLY AT LED WITH UNSHIELDED EYES OR DAMAGE TO RETINA MAY OCCUR.

OPTEK reserves the right to make changes at any time in order to improve design and to supply the best product possible.

Absolute Maximum Ratings

DC Forward Current /die	700 mA
Peak Pulsed Forward Current ¹	6.0 A
Reverse Voltage	5 V
Maximum Allowable Junction Temperature ²	130° C
Storage and Operating Temperature	-50° ~ +100° C

Notes:

1. Pulse width 1 ms maximum. Duty cycle 1/16.
2. Thermal Resistance junction to Board (T_{jhs}) is <2° C/W

Electrical Characteristics ($I_F = 350 \text{ mA}$, $T_J = 25^\circ \text{ C}$)

SYMBOL	PARAMETER	MIN	TYP	MAX	UNITS
V_F	Forward Voltage (Amber)	7.1	8.6	10.0	V
	Forward Voltage (Blue)	10.2	12.6	13.7	V
	Forward Voltage (Cyan & Green)	10.0	13.1	14.1	V
	Forward Voltage (Red)	7.0	8.7	10.1	V
	Forward Voltage (White)	10.2	12.6	13.7	V
	$V_{F_}$ Temperature Co-efficient (Amber & Red)	----	-6.42	----	mV/°C
	$V_{F_}$ Temperature Co-efficient (White & Blue)	----	-4.81	----	mV/°C
	$V_{F_}$ Temperature Co-efficient (Cyan & Green)	----	-4.95	----	mV/°C

Optical Characteristics ($I_F = 350 \text{ mA/die}$, $T_J = 25^\circ \text{ C}$)

COLOR	DOMINANT WAVELENGTH			SPECTRAL FULL-WIDTH HALF-MAXIMUM	DOMINANT WAVELENGTH TEMPERATURE DEPENDENCE
	MIN	TYP	MAX		
Amber	585	590	595	16 nm	0.07 nm/° C
Blue	455	458	460	20 nm	0.044 nm/° C
Green	530	532	535	40nm	0.04 nm/° C
Red	620	625	630	37 nm	0.05 nm/° C

Color	Minimum CCT (°K)	Maximum CCT (°K)
Cool White	6000	8000
Daylight White	4750	6000
Warm White	2760	3800

OPTEK's Solid State Lighting products package the highest quality LED chips. Typically, the lumen output of these can be as high as 70% after 50,000 hours of operation. This prediction is based on specific test results and on tests on similar materials, and relies on strict observation of the design limits and ratings included in this data sheet.

OPTEK reserves the right to make changes at any time in order to improve design and to supply the best product possible.

CIE Chromaticity Diagram

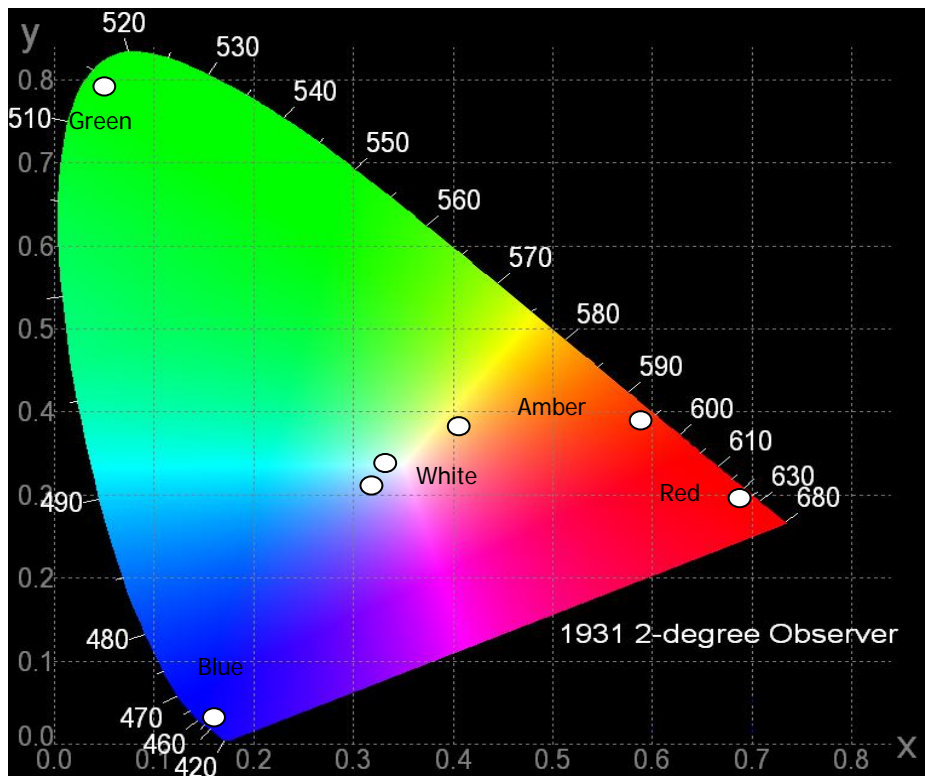

Spatial Intensity Distribution

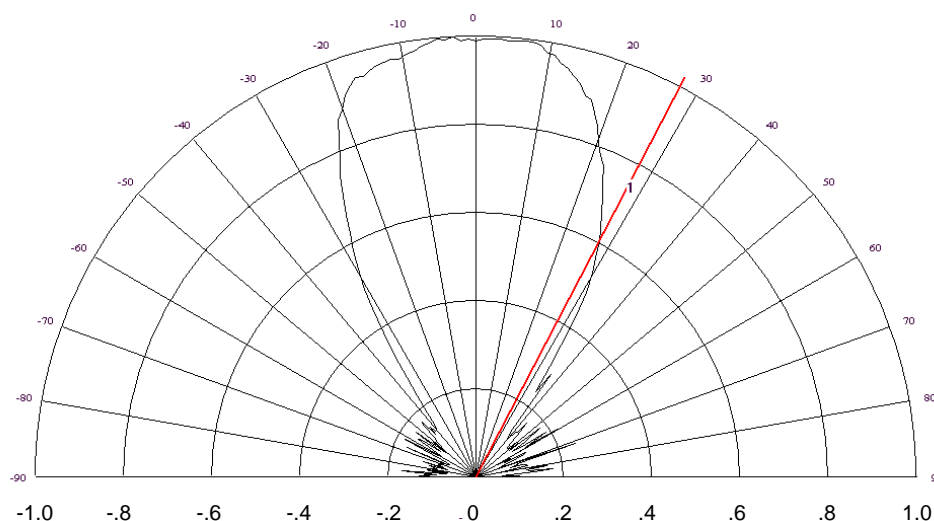

Normalized Spectral Intensity vs Angular Displacement

60.1 degrees

OPTEK reserves the right to make changes at any time in order to improve design and to supply the best product possible.

Optimal IV COS Star OV4Zxxxx Series

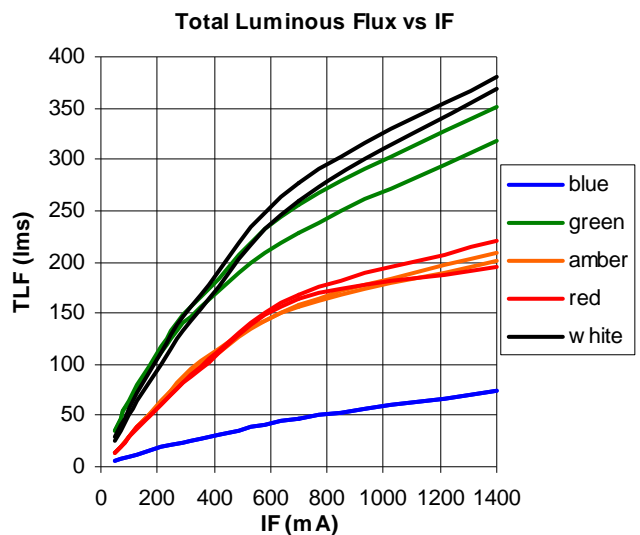
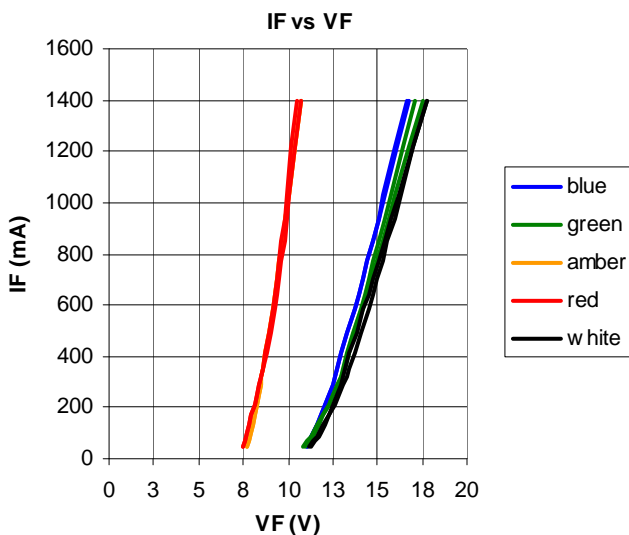
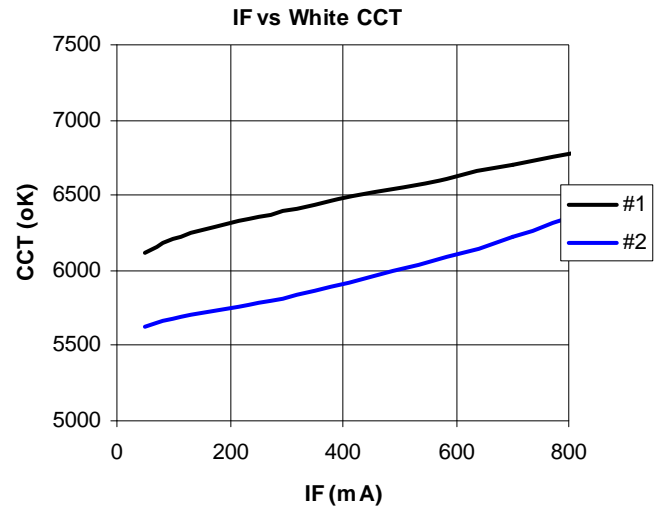
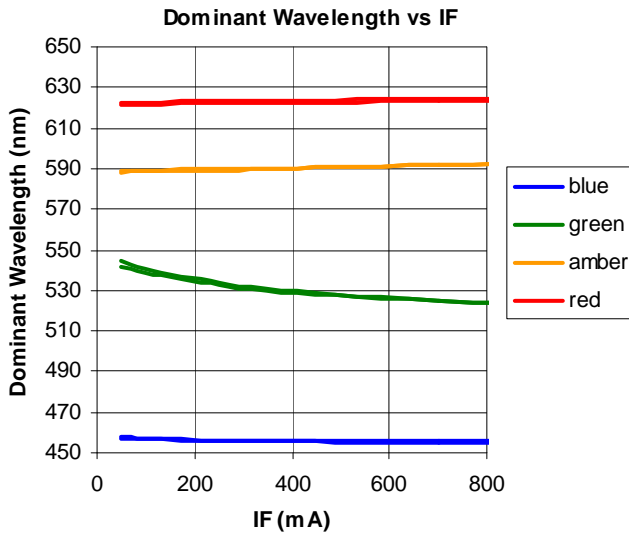
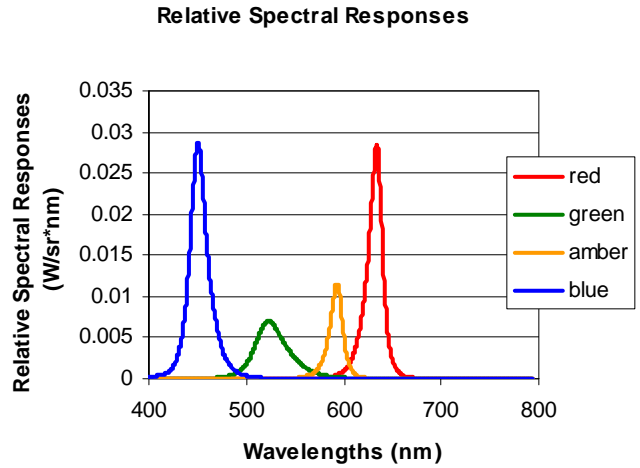
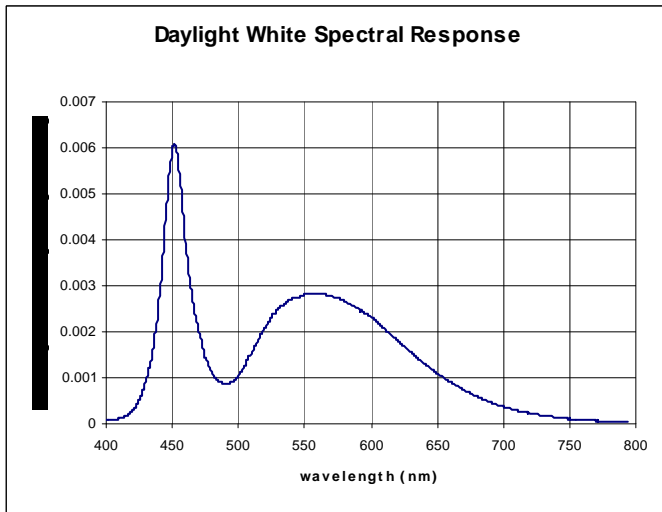

OPTEK reserves the right to make changes at any time in order to improve design and to supply the best product possible.

Red Dominant Wavelength vs Junction Temperature

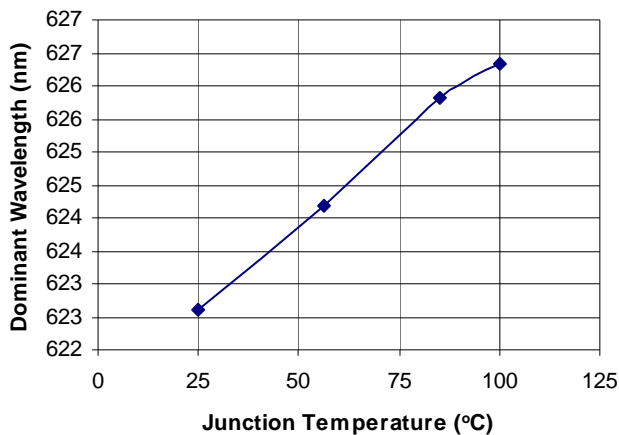

Forward Voltage vs Junction Temperature

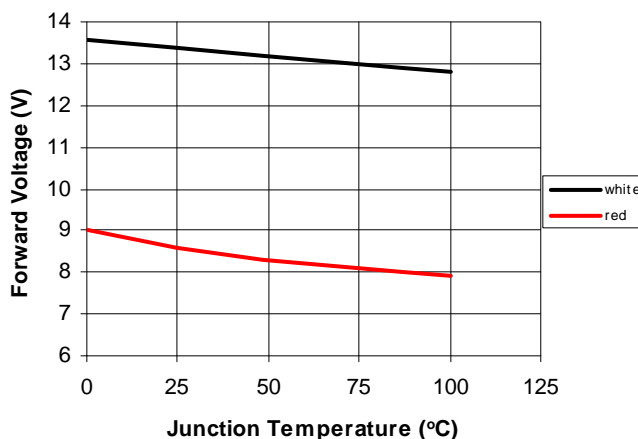

White CCT vs Junction Temperature

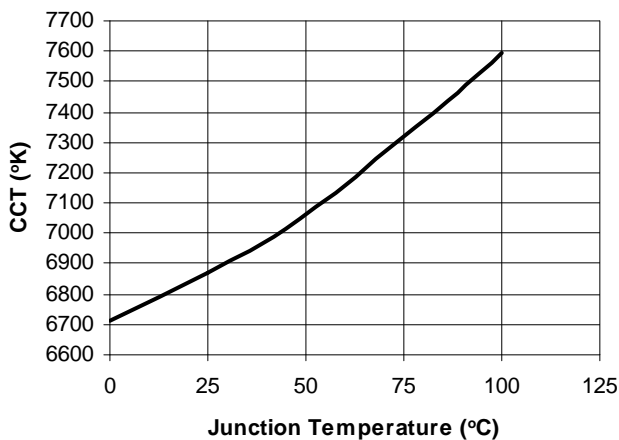

Normalized TLF @ 25°C vs Junction Temperature

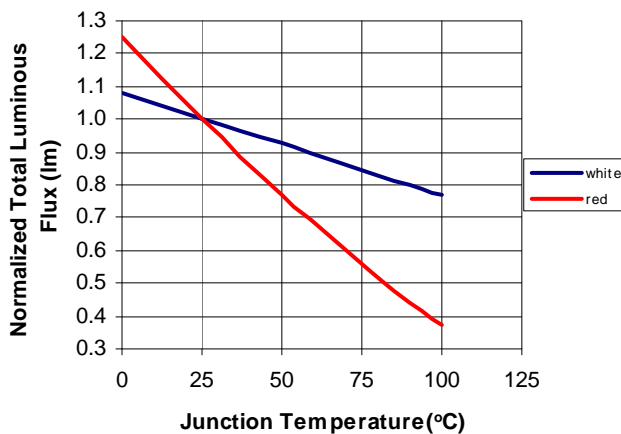

Duty Ratio vs. Allowable Forward Current
T = 1 ms & variable PW

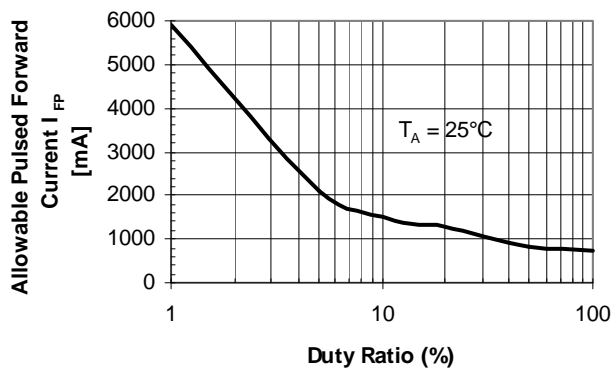

Derating Curve

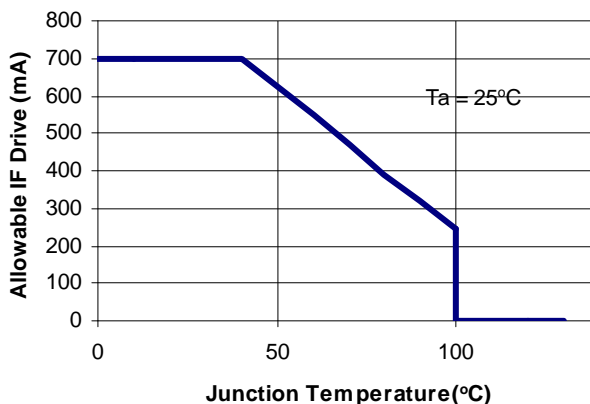

OPTEK reserves the right to make changes at any time in order to improve design and to supply the best product possible.

Optimal IV COS Star

OV4Zxxxx Series

Shipment Packaging and Packing:

1. Packaging quantity : 10 stars / tube
2. Packing box contains 10 tubes
3. Shipment of 10 Packing Boxes in Cardboard Box (26.5 mm x 34.5 mm x18 mm)

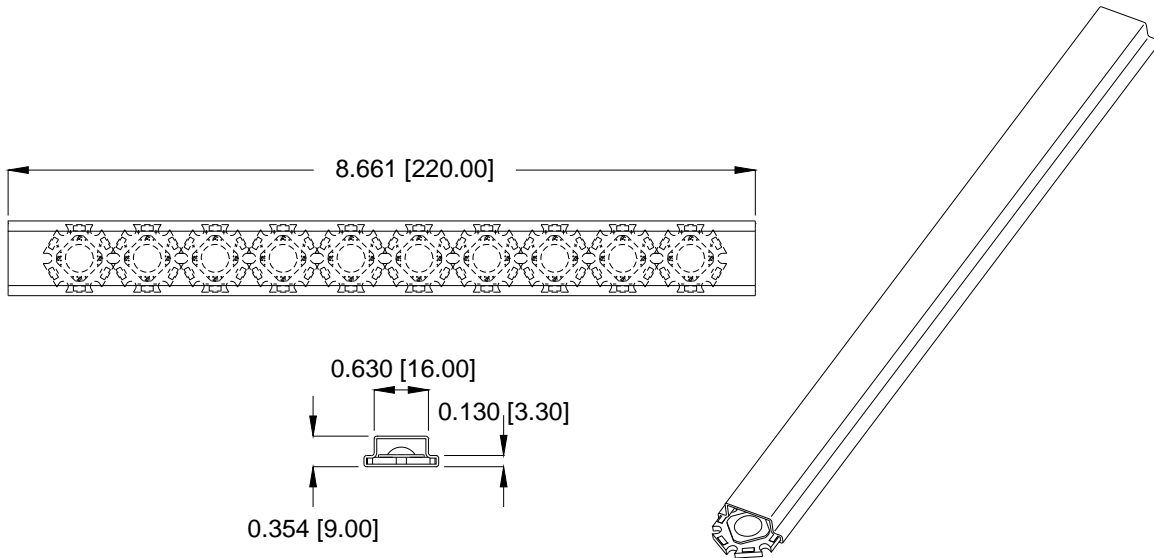

OPTEK reserves the right to make changes at any time in order to improve design and to supply the best product possible.