

ASMT-MxK0

1W Power LED Light Source on MCPCB

Preliminary Datasheet

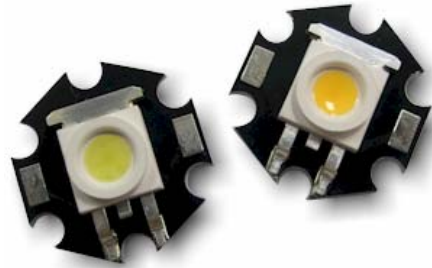

Description

1W Power LED Light Source is a high performance energy efficient device which can handle high thermal and high driving current. The exposed pad design has excellent heat transfer from the package to the motherboard.

The Cool White Power LED is available in various color temperature ranging from 4000K to 10000K and Warm White Power LED ranging from 2600K to 4000K. The product has high Color Rendering Index (CRI) which provides excellent color perception and visual clarity.

The low profile package design is suitable for a wide variety of applications especially where height is a constraint.

Features

- Available in Green, Blue, Cool White and Warm White color.
- Energy efficient
- High current operation.
- Long operation life.
- Wide viewing angle.
- Silicone encapsulation

Specifications

- InGaN Technology
- 3.6V, 350 mA (typical)
- 110 viewing angle

Applications

- Portable (flash light, bicycle head light)
- Reading light
- Architectural lighting
- Garden lighting
- Decorative lighting

This preliminary data is provided to assist you in the evaluation of product(s) currently under development. Until Avago Technologies releases this product for general sales, Avago Technologies reserves the right to alter prices, specifications, features, capabilities, functions, release dates, and remove availability of the product(s) at anytime.

Package Dimensions

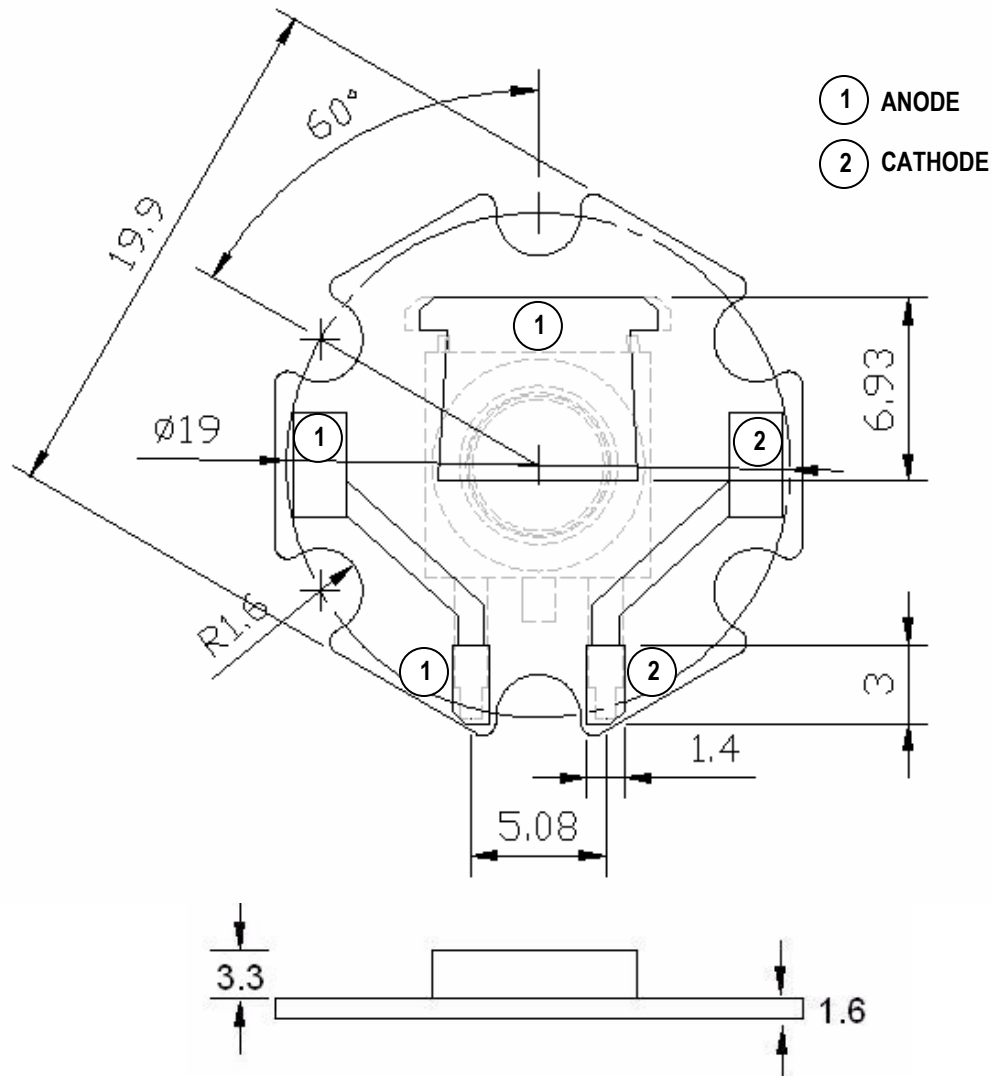

NOTES:

1. ALL DIMENSIONS IN MILLIMETERS.
2. TOLERANCE IS ± 0.1 MM UNLESS OTHERWISE SPECIFIED.

Device Selection Guide at Junction Temperature $T_j = 25^\circ\text{C}$

Color	Part Number	Luminous Flux, $\Phi_v^{[1,2,3]}$ (lm)			Test Current (mA)	Dice Technology
		Min	Typ	Max		
Green	ASMT-MGK0	25.5	40.0	73.0	350	InGaN
Blue	ASMT-MBK0	5.5	10.0	19.5	350	InGaN
Cool White	ASMT-MWK0	43.0	60.0	73.0	350	InGaN
Warm White	ASMT-MYK0	43.0	50.0	73.0	350	InGaN

Notes:

1. Φ_v is the total luminous flux output as measured with an integrating sphere at 25ms mono pulse condition.
2. Flux tolerance is $\pm 10\%$
3. Φ_v data are only applicable for ASMT-Mx00 component level device only.

This preliminary data is provided to assist you in the evaluation of product(s) currently under development. Until Avago Technologies releases this product for general sales, Avago Technologies reserves the right to alter prices, specifications, features, capabilities, functions, release dates, and remove availability of the product(s) at anytime.

Part Numbering System

ASMT-M x K0 – N x₁ x₂ x₃ 0

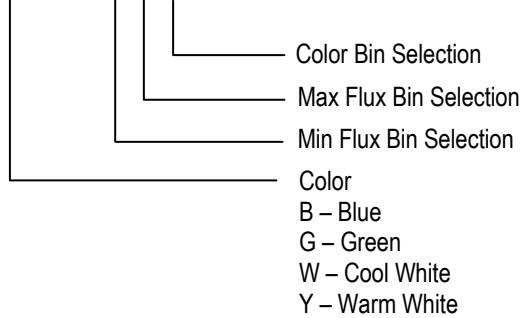

Absolute Maximum Ratings^[3] at T_A = 25°C

Parameter	ASMT-MxK0	Units
DC Forward Current ^[1]	350	mA
Peak Pulsing Current ^[2]	500	mA
Power Dissipation	1400	mW
LED Junction Temperature	110	°C
Operating Ambient Temperature Range	-40 to +85	°C
Storage Temperature Range	-40 to +100	°C

Note:

1. DC forward current – derate linearly based on Figure 5.
2. Pulse condition duty factor = 10%, Frequency = 1kHz.
3. Absolute Maximum Rating data are only applicable for ASMT-Mx00 component level device only.

Optical Characteristics^[3] (T_A = 25 °C)

Part Number	Color	Peak Wavelength	Dominant Wavelength	Viewing Angle	Luminous Efficiency
		λ_{PEAK} (nm)	λ_D ^[1] (nm)	$2\theta_{1/2}$ ^[2] (Degrees)	(lm/W)
		Typ.	Typ.	Typ.	Typ.
ASMT-MGK0	Green	519	525	120	32
ASMT-MBK0	Blue	460	467	120	8

Part Number	Color	Correlated Color Temperature, CCT (Kelvin)		Viewing Angle	Luminous Efficiency
		Min	Max	$2\theta_{1/2}$ ^[2] (Degrees)	(lm/W)
		Typ	Typ	Typ	Typ
ASMT-MWK0	Cool White	4000	10000	110	48
ASMT-MYK0	Warm White	2600	4000	110	40

Notes:

1. The dominant wavelength, λ_D , is derived from the CIE Chromaticity Diagram and represents the color of the device.
2. $\theta_{1/2}$ is the off-axis angle where the luminous intensity is $\frac{1}{2}$ the peak intensity.
3. Optical Characteristics data are only applicable for ASMT-Mx00 component level device only.

Electrical Characteristic^[2] (T_A = 25°C)

Dice Type	Forward Voltage V _F (Volts) @ I _F = 350mA		Reverse Voltage V _R (Volts)	Thermal Resistance R _{θj-b} (°C/W) ^[1]
	Typ	Max.	Max.	Typ.
InGaN	3.6	4.0	5	18

Note:

1. R_{θj-b} is Thermal Resistance from LED junction to MCPCB.
2. Electrical Characteristic data are only applicable for ASMT-Mx00 component level device only.

This preliminary data is provided to assist you in the evaluation of product(s) currently under development. Until Avago Technologies releases this product for general sales, Avago Technologies reserves the right to alter prices, specifications, features, capabilities, functions, release dates, and remove availability of the product(s) at anytime.

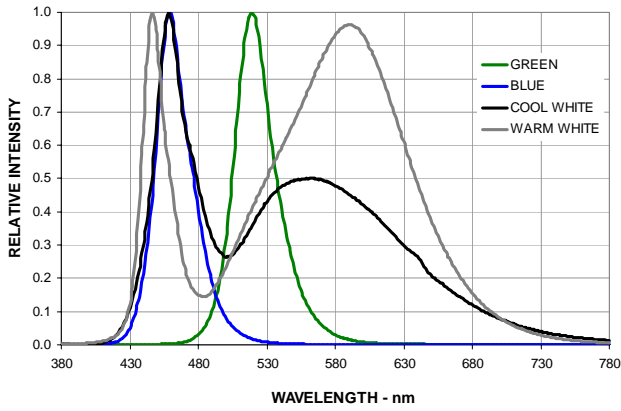

Figure 1: Relative Intensity vs. Wavelength

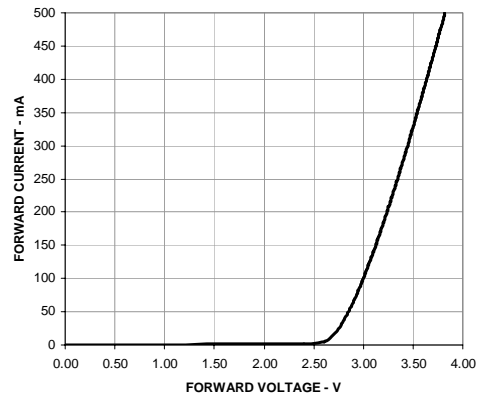

Figure 2: Forward Current vs Forward Voltage

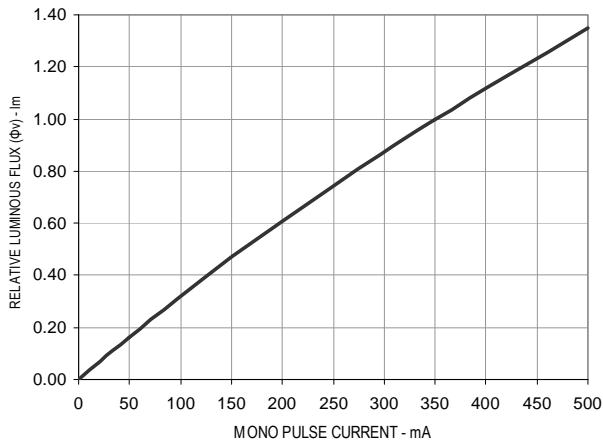

Figure 3: Relative Luminous Flux vs. Mono Pulse Current

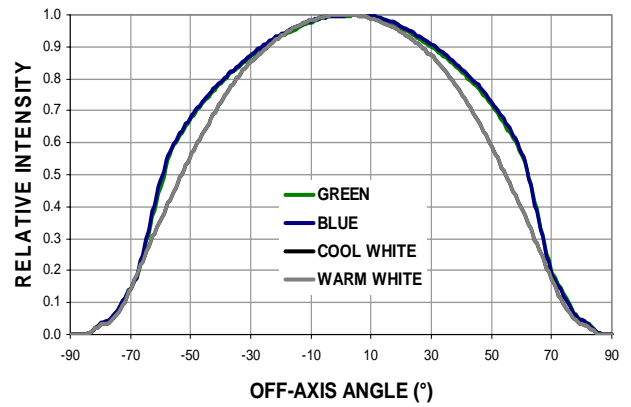

Figure 4: Radiation Pattern

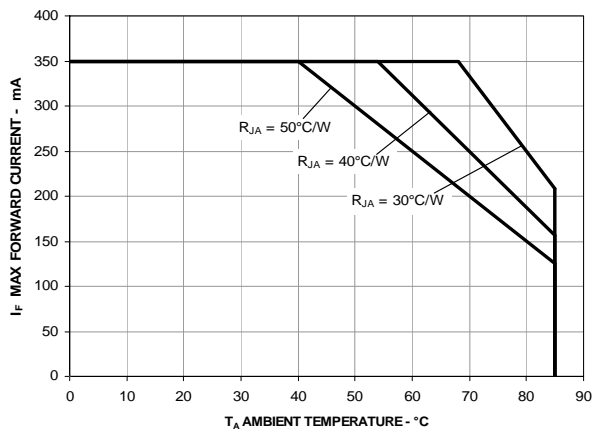

Figure 5. Maximum forward current vs. ambient temperature
Derated based on $T_{JMAX} = 110^\circ\text{C}$, $R_{\theta JA} = 30^\circ\text{C/W}$ / 40°C/W and 50°C/W

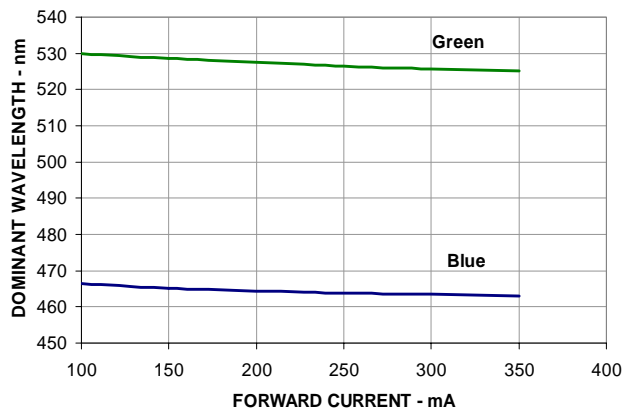

Figure 6: Dominant wavelength vs. forward current – InGaN devices

For product information and a complete list of distributors, please go to our web site: www.avagotech.com

Avago, Avago Technologies, and the A logo are trademarks of Avago Technologies, Pte. in the United States and other countries. Data subject to change. Copyright © 2005 Avago Technologies Pte. All rights reserved. Obsoletes Pub No. Pub Number - Date (10/Oct/06) Rev E



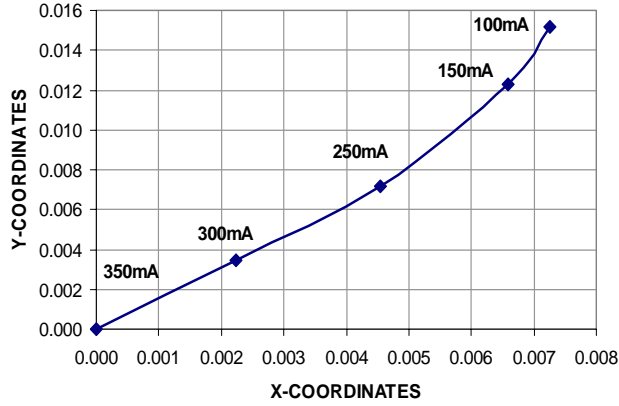

Figure 7: Chromaticity Shift vs. Current
 *Note: (x,y) values @ 350mA reference to (0.0)

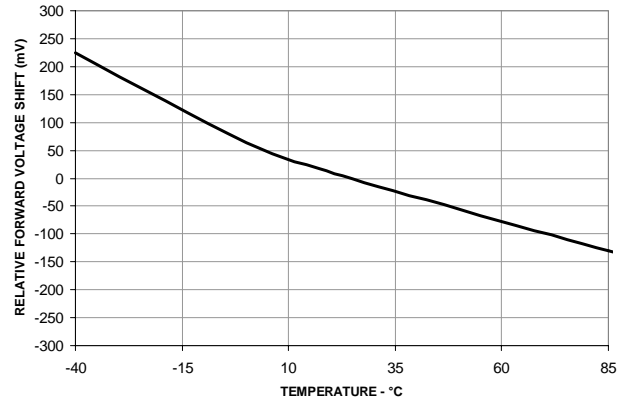

Figure 8: Temperature vs. relative forward voltage shift

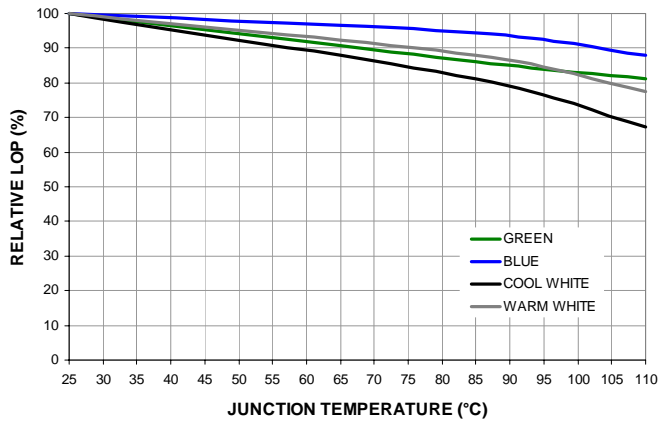

Figure 9: Relative LOP vs. junction temperature

Note: All parametric charts are only applicable for ASMT-Mx00 component level device only.

For product information and a complete list of distributors, please go to our web site: www.avagotech.com

Avago, Avago Technologies, and the A logo are trademarks of Avago Technologies, Pte. in the United States and other countries. Data subject to change. Copyright © 2005 Avago Technologies Pte. All rights reserved. Obsoletes Pub No. Pub Number - Date (10/Oct/06) Rev E



Flux Bin Limit⁽¹⁾ (For reference only) [x₁ x₂]

Bin	Flux (lm) at 350mA	
	Min	Max
A	5.5	7.0
B	7.0	9.0
C	9.0	11.5
D	11.5	15.0
E	15.0	19.5
F	19.5	25.5
G	25.5	33.0
H	33.0	43.0
J	43.0	56.0

Tolerance for each bin limits is $\pm 10\%$

Note:

1. Flux Bin Limit is only applicable for ASMT-Mx00 component level device only

Color Bin Selections [x₃]

Individual reel will contain parts from one full bin only.

Cool White

0	Full Distribution
A	A only
B	B only
C	C only
D	D only
E	E only
F	F only
G	G only
H	H only
Z	A and B only
Y	B and C only
W	C and D only
V	D and E only
U	E and F only
T	F and G only
S	G and H only
Q	A, B and C only
P	B, C and D only
N	C, D and E only
M	D, E and F only
L	E, F and G only
K	F, G and H only
J	Special Color Bin
1	A, B, C and D only
2	E, F, G and H only
3	B, C, D and E only
4	C, D, E and F only
5	A, B, C, D and E only
6	B, C, D, E, and F only

Color Bin Limits

Blue	Min. (nm)	Max. (nm)
A	460.0	465.0
B	465.0	470.0
C	470.0	475.0
D	475.0	480.0

Green	Min. (nm)	Max. (nm)
A	515.0	520.0
B	520.0	525.0
C	525.0	530.0
D	530.0	535.0

Warm White

0	Full Distribution
A	A only
B	B only
C	C only
D	D only
E	E only
F	F only
Z	A and B only
Y	B and C only
W	C and D only
V	D and E only
U	E and F only
Q	A, B and C only
P	B, C and D only
N	C, D and E only
M	D, E and F only
J	Special Color Bin
1	A, B, C and D only
2	E, F, G and H only
3	B, C, D and E only
4	C, D, E and F only
5	A, B, C, D and E only
6	B, C, D, E, and F only

For product information and a complete list of distributors, please go to our web site: www.avagotech.com

Avago, Avago Technologies, and the A logo are trademarks of Avago Technologies, Pte. in the United States and other countries. Data subject to change. Copyright © 2005 Avago Technologies Pte. All rights reserved. Obsoletes Pub No. Pub Number - Date (10/Oct/06) Rev E

AVAGO
TECHNOLOGIES

Primary Color Binning

Cool White	Color Limits ^[1] (Chromaticity Coordinates)				
Bin A	X	0.367	0.362	0.329	0.329
	Y	0.400	0.372	0.345	0.369
Bin B	X	0.362	0.356	0.329	0.329
	Y	0.372	0.330	0.302	0.345
Bin C	X	0.329	0.329	0.305	0.301
	Y	0.369	0.345	0.322	0.342
Bin D	X	0.329	0.329	0.311	0.305
	Y	0.345	0.302	0.285	0.322
Bin E	X	0.303	0.307	0.283	0.274
	Y	0.333	0.311	0.284	0.301
Bin F	X	0.307	0.311	0.290	0.283
	Y	0.311	0.285	0.265	0.284
Bin G	X	0.388	0.379	0.362	0.367
	Y	0.417	0.383	0.372	0.400
Bin H	X	0.379	0.369	0.356	0.362
	Y	0.383	0.343	0.330	0.372

Tolerances ± 0.01

Warm White	Color Limits ^[1] (Chromaticity Coordinates)				
Bin A	X	0.452	0.488	0.470	0.438
	Y	0.434	0.447	0.414	0.403
Bin B	X	0.438	0.470	0.452	0.424
	Y	0.403	0.414	0.384	0.376
Bin C	X	0.407	0.418	0.452	0.438
	Y	0.393	0.422	0.434	0.403
Bin D	X	0.395	0.407	0.438	0.424
	Y	0.362	0.393	0.403	0.376
Bin E	X	0.381	0.387	0.418	0.407
	Y	0.377	0.404	0.422	0.393
Bin F	X	0.373	0.381	0.407	0.395
	Y	0.349	0.377	0.393	0.362

Tolerances ± 0.01

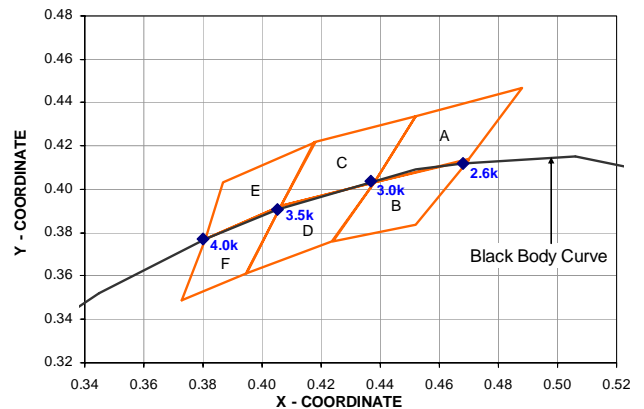
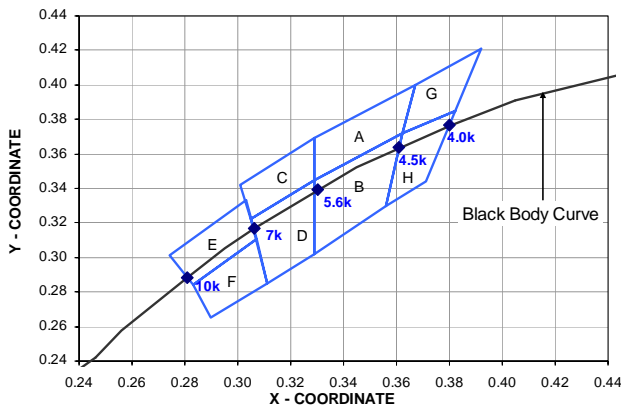

Note:

- Color Limit and Color binning chart are only applicable for ASMT-Mx00 component level device only

For product information and a complete list of distributors, please go to our web site: www.avagotech.com

Avago, Avago Technologies, and the A logo are trademarks of Avago Technologies, Pte. in the United States and other countries. Data subject to change. Copyright © 2005 Avago Technologies Pte. All rights reserved. Obsolesces Pub No. Pub Number - Date (10/Oct/06) Rev E

AVAGO
TECHNOLOGIES

Sub-Color Binning

(Only Applicable for Color Bin A to Bin D and Bin G to Bin H)

Color Limits⁽¹⁾

Cool White	(Chromaticity Coordinates)				
Bin A1	X	0.364	0.367	0.348	0.347
	Y	0.383	0.400	0.385	0.372
Bin A2	X	0.364	0.362	0.346	0.347
	Y	0.383	0.372	0.359	0.372
Bin A3	X	0.329	0.329	0.348	0.347
	Y	0.357	0.369	0.385	0.372
Bin A4	X	0.329	0.329	0.347	0.346
	Y	0.345	0.357	0.372	0.359
Bin B1	X	0.362	0.360	0.344	0.346
	Y	0.372	0.357	0.344	0.359
Bin B2	X	0.360	0.358	0.343	0.344
	Y	0.357	0.343	0.331	0.344
Bin B3	X	0.358	0.356	0.341	0.343
	Y	0.343	0.330	0.314	0.331
Bin B4	X	0.329	0.329	0.346	0.344
	Y	0.331	0.345	0.359	0.344
Bin B5	X	0.329	0.344	0.343	0.329
	Y	0.331	0.344	0.331	0.320
Bin B6	X	0.343	0.341	0.329	0.329
	Y	0.331	0.314	0.302	0.320
Bin C1	X	0.329	0.329	0.315	0.314
	Y	0.369	0.357	0.344	0.355
Bin C2	X	0.329	0.329	0.316	0.315
	Y	0.357	0.345	0.333	0.344
Bin C3	X	0.314	0.315	0.303	0.301
	Y	0.355	0.344	0.333	0.342
Bin C4	X	0.315	0.316	0.305	0.303
	Y	0.344	0.333	0.322	0.333

Cool White	(Chromaticity Coordinates)				
Bin D1	X	0.329	0.329	0.317	0.316
	Y	0.345	0.331	0.320	0.333
Bin D2	X	0.329	0.329	0.318	0.317
	Y	0.331	0.320	0.310	0.320
Bin D3	X	0.329	0.329	0.320	0.318
	Y	0.320	0.302	0.293	0.310
Bin D4	X	0.316	0.317	0.307	0.305
	Y	0.333	0.320	0.311	0.322
Bin D5	X	0.317	0.318	0.309	0.307
	Y	0.320	0.310	0.300	0.311
Bin D6	X	0.318	0.320	0.311	0.309
	Y	0.310	0.293	0.285	0.300
Bin G1	X	0.392	0.386	0.364	0.367
	Y	0.421	0.400	0.383	0.400
Bin G2	X	0.386	0.382	0.362	0.364
	Y	0.400	0.385	0.372	0.383
Bin H1	X	0.382	0.378	0.360	0.362
	Y	0.385	0.370	0.357	0.372
Bin H2	X	0.378	0.375	0.358	0.360
	Y	0.370	0.358	0.343	0.357
Bin H3	X	0.375	0.371	0.356	0.358
	Y	0.358	0.344	0.330	0.343

Tolerances ± 0.01

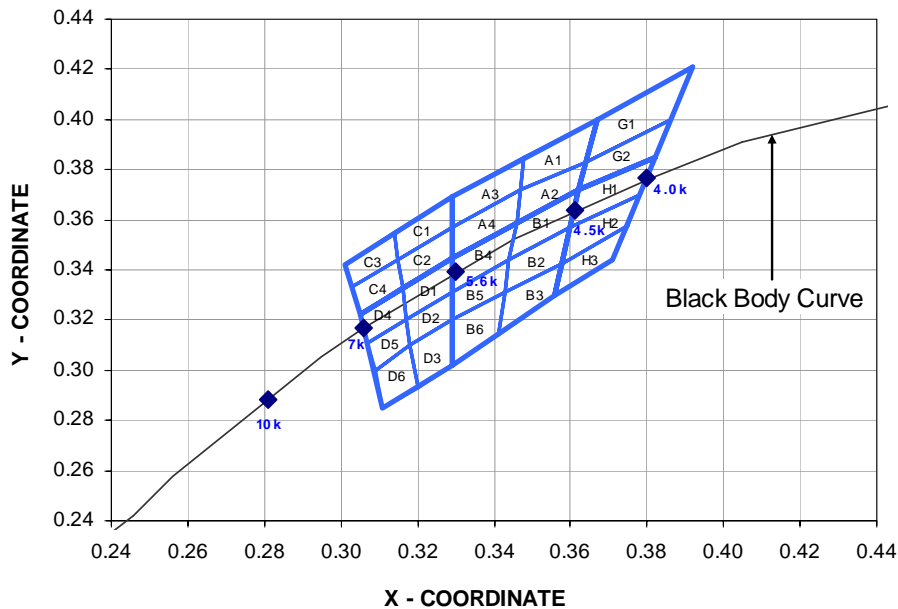

Note:

- Color Limit and Color binning chart are only applicable for ASMT-Mx00 component level device only

For product information and a complete list of distributors, please go to our web site: www.avagotech.com

Avago, Avago Technologies, and the A logo are trademarks of Avago Technologies, Pte. in the United States and other countries. Data subject to change. Copyright © 2005 Avago Technologies Pte. All rights reserved. Obsoletes Pub No. Pub Number - Date (10/Oct/06) Rev E

AVAGO
TECHNOLOGIES

Package Tray Dimensions

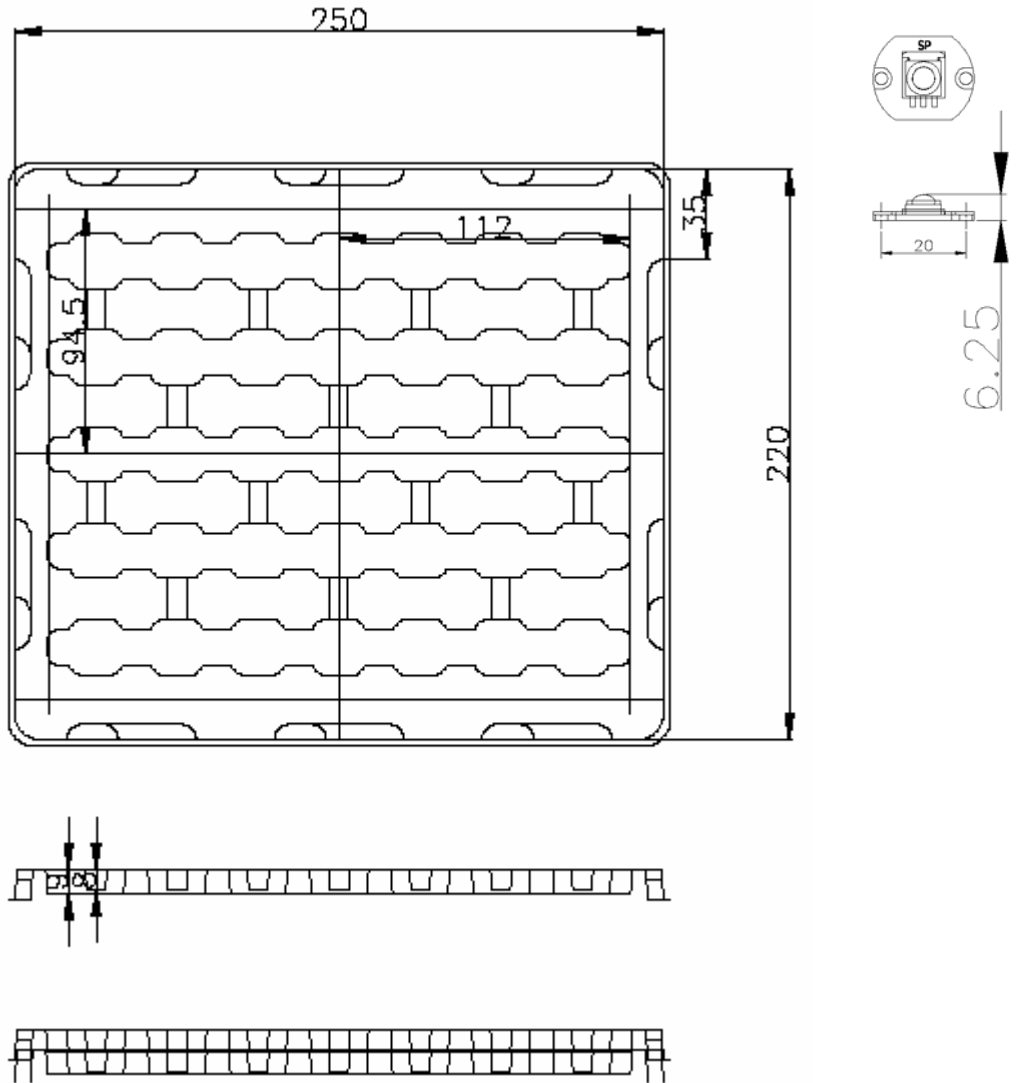

For product information and a complete list of distributors, please go to our web site: www.avagotech.com

Avago, Avago Technologies, and the A logo are trademarks of Avago Technologies, Pte. in the United States and other countries. Data subject to change. Copyright © 2005 Avago Technologies Pte. All rights reserved. Obsoletes Pub No. Pub Number - Date (10/Oct/06) Rev E



Handling Precaution

The encapsulation material of the product is made of silicone for better reliability of the product. As silicone is a soft material, please do not press on the silicone or poke a sharp object onto the silicone. These might damage the product and cause premature failure. During assembly or handling, the unit should be held on the body (white plastic).

DISCLAIMER

AVAGO'S PRODUCTS AND SOFTWARE ARE NOT SPECIFICALLY DESIGNED, MANUFACTURED OR AUTHORIZED FOR SALE AS PARTS, COMPONENTS OR ASSEMBLIES FOR THE PLANNING, CONSTRUCTION, MAINTENANCE OR DIRECT OPERATION OF A NUCLEAR FACILITY OR FOR USE IN MEDICAL DEVICES OR APPLICATIONS. CUSTOMER IS SOLELY RESPONSIBLE, AND WAIVES ALL RIGHTS TO MAKE CLAIMS AGAINST AVAGO OR ITS SUPPLIERS, FOR ALL LOSS, DAMAGE, EXPENSE OR LIABILITY IN CONNECTION WITH SUCH USE.

For product information and a complete list of distributors, please go to our web site: www.avagotech.com

Avago, Avago Technologies, and the A logo are trademarks of Avago Technologies, Pte. in the United States and other countries.
Data subject to change. Copyright © 2005 Avago Technologies Pte. All rights reserved. Obsoletes Pub No.
Pub Number - Date (10/Oct/06) Rev E

