

## Phototriac, Zero Crossing, 1.5 kV/μs dV/dt, 600 V

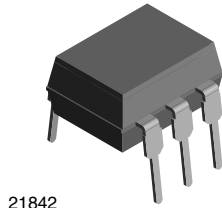

21842

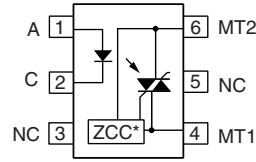

\*Zero crossing circuit

i179030\_2

### DESCRIPTION

The VO3062, VO3063 triac driver family consists of a GaAs infrared LED optically coupled to a monolithic photosensitive zero crossing triac detector chip. The 600 V blocking voltage permits control of off-line voltages up to 240 VAC, with a safety factor of more than two, and is sufficient for as much as 380 V.

### FEATURES

- 1500 V/μs dV/dt minimum
- 600 V blocking voltage
- 100 mA on-state current
- Zero crossing detector
- Low input trigger current
- 6 pin DIP package
- Compliant to RoHS directive 2002/95/EC and in accordance to WEEE 2002/96/EC

**RoHS**  
COMPLIANT

### APPLICATIONS

- Household appliances
- Triac drive/AC motor drives
- Solenoid/valve controls
- Office automation equipment/machine
- Temperature (HVAC)/lighting controls
- Switching power supply

### AGENCY APPROVALS

- UL1577, file no. E52744 system code H
- CUL - file no. E52744, equivalent to CSA bulletin 5A
- DIN EN 60747-5-5 (VDE 0884) available with option 1

ORDER INFORMATION	
PART	REMARKS
VO3063	DIP-6, ZC, 600 V, I <sub>FT</sub> = 5 mA
VO3062	DIP-6, ZC, 600 V, I <sub>FT</sub> = 10 mA
VO3063-X006	DIP-6 400 mil, ZC, 600 V, I <sub>FT</sub> = 5 mA
VO3062-X006	DIP-6 400 mil, ZC, 600 V, I <sub>FT</sub> = 10 mA
VO3063-X007T	SMD-6, ZC, 600 V, I <sub>FT</sub> = 5 mA
VO3062-X007T	SMD-6, ZC, 600 V, I <sub>FT</sub> = 10 mA

#### Note

For additional information on the available options refer to option information. This phototriac should not be used to drive a load directly. It is intended to be a trigger device only.

ABSOLUTE MAXIMUM RATINGS (1)					
PARAMETER	TEST CONDITION	PART	SYMBOL	VALUE	UNIT
<b>INPUT</b>					
Reverse voltage			V <sub>R</sub>	6	V
Forward current - continuous			I <sub>F</sub>	60	mA
Power dissipation			P <sub>diss</sub>	100	mW
<b>OUTPUT</b>					
Off state output terminal voltage		VO3062, VO3063	V <sub>DRM</sub>	600	V
Peak repetitive surge current	PW = 100 μs, 120 pps		I <sub>TSM</sub>	1	A
Power dissipation			P <sub>diss</sub>	200	mW
On-state RMS current			I <sub>T(RMS)</sub>	100	mA

ABSOLUTE MAXIMUM RATINGS (1)					
PARAMETER	TEST CONDITION	PART	SYMBOL	VALUE	UNIT
<b>COUPLER</b>					
Isolation test voltage	t = 1 s		V <sub>ISO</sub>	5300	V <sub>RMS</sub>
Total power dissipation			P <sub>tot</sub>	300	mW
Operating temperature range			T <sub>amb</sub>	- 40 to + 100	°C
Storage temperature range			T <sub>stg</sub>	- 55 to + 150	°C
Soldering temperature (2)	maximum $\leq$ 10 s		T <sub>slid</sub>	260	°C

**Notes**

(1) T<sub>amb</sub> = 25 °C, unless otherwise specified.

Stresses in excess of the absolute maximum ratings can cause permanent damage to the device. Functional operation of the device is not implied at these or any other conditions in excess of those given in the operational sections of this document. Exposure to absolute maximum ratings for extended periods of the time can adversely affect reliability.

(2) Refer to reflow profile for soldering conditions for surface mounted devices (SMD). Refer to wave profile for soldering conditions for through hole devices (DIP).

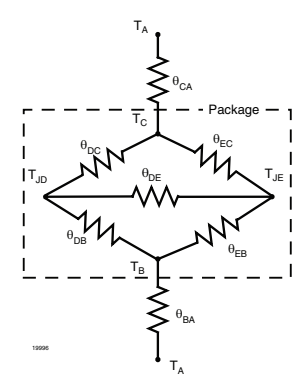
THERMAL CHARACTERISTICS				
PARAMETER	SYMBOL	VALUE	UNIT	
Maximum LED junction temperature	T <sub>jmax.</sub>	125	°C	
Maximum output die junction temperature	T <sub>jmax.</sub>	125	°C	
Thermal resistance, junction emitter to board	$\theta_{JEB}$	150	°C/W	
Thermal resistance, junction emitter to case	$\theta_{JEC}$	139	°C/W	
Thermal resistance, junction detector to board	$\theta_{JDB}$	78	°C/W	
Thermal resistance, junction detector to case	$\theta_{JDC}$	103	°C/W	
Thermal resistance, junction emitter to junction detector	$\theta_{JED}$	496	°C/W	
Thermal resistance, case to ambient	$\theta_{CA}$	3563	°C/W	

**Note**

The thermal model is represented in the thermal network below. Each resistance value given in this model can be used to calculate the temperatures at each node for a given operating condition. The thermal resistance from board to ambient will be dependent on the type of PCB, layout and thickness of copper traces. For a detailed explanation of the thermal model, please reference Vishay's Thermal Characteristics of Optocouplers application note.

ELECTRICAL CHARACTERISTICS							
PARAMETER	TEST CONDITION	PART	SYMBOL	MIN.	TYP.	MAX.	UNIT
<b>INPUT</b>							
Reverse current	V <sub>R</sub> = 6 V		I <sub>R</sub>			10	$\mu$ A
Forward voltage	I <sub>F</sub> = 30 mA		V <sub>F</sub>		1.2	1.5	V
<b>OUTPUT</b>							
Leakage with LED off, either direction	V <sub>DRM</sub> = 600 V		I <sub>DRM</sub>		10	500	nA
Critical rate of rise off-state voltage	V <sub>D</sub> = 400 V		dV/dt	1500	2000		V/ $\mu$ s



<b>ELECTRICAL CHARACTERISTICS</b>							
PARAMETER	TEST CONDITION	PART	SYMBOL	MIN.	TYP.	MAX.	UNIT
<b>COUPLER</b>							
LED trigger current, current required to latch output		VO3063	I <sub>FT</sub>			5	mA
		VO3062	I <sub>FT</sub>			10	mA
Peak on-state voltage, either direction	I <sub>TM</sub> = 100 mA Peak, I <sub>F</sub> = Rated I <sub>FT</sub>		V <sub>TM</sub>		1.7	3	V
Holding current, either direction			I <sub>H</sub>		200		μA
Inhibit voltage (MT1-MT2 voltage above which device will not trigger)			V <sub>INH</sub>		12	22	V
Leakage in inhibited state	I <sub>F</sub> = 10 mA maximum, at rated V <sub>DRM</sub> , off state		V <sub>DRM2</sub>		250	1000	μA

**Note**

T<sub>amb</sub> = 25 °C, unless otherwise specified.

Typical values are characteristics of the device and are the result of engineering evaluations. Typical values are for information only and are not part of the testing requirements.

<b>SAFETY AND INSULATION RATINGS</b>							
PARAMETER	TEST CONDITION	SYMBOL	MIN.	TYP.	MAX.	UNIT	
Climatic classification	IEC 68 part 1			40/85/21			
Pollution degree	DIN VDE 0109			2			
Comparative tracking index per DIN IEC 112/VDE 0303 part 1, group IIIa per DIN VDE 6110 175 399		CTI	175				
Highest allowable overvoltage	Transient overvoltage	V <sub>IOTM</sub>	8000			V <sub>peak</sub>	
Maximum working insulation voltage	Recurring peak voltage	V <sub>IORM</sub>	890			V <sub>peak</sub>	
Insulation resistance at 25 °C	V <sub>IO</sub> = 500 V	R <sub>IS</sub>			≥ 10 <sup>12</sup>	Ω	
Insulation resistance at T <sub>S</sub>	V <sub>IO</sub> = 500 V	R <sub>IS</sub>			≥ 10 <sup>9</sup>	Ω	
Insulation resistance at 100 °C	V <sub>IO</sub> = 500 V	R <sub>IS</sub>			≥ 10 <sup>11</sup>	Ω	
Partial discharge test voltage	Method a, V <sub>pd</sub> = V <sub>IORM</sub> × 1.875	V <sub>pd</sub>			1325	V <sub>peak</sub>	
Safety limiting values - maximum values allowed in the event of a failure	Safety power rating	P <sub>SO</sub>			400	mW	
	Safety current rating	I <sub>SI</sub>			150	mA	
	Safety temperature rating	T <sub>SI</sub>			165	°C	
Minimum external air gap (clearance)	Measured from input terminals to output terminals, shortest distance through air		≥ 7			mm	
Minimum external tracking (creepage)	Measured from input terminals to output terminals, shortest distance path along body		≥ 7			mm	

**Note**

As per IEC 60747-5-5, § 7.4.3.8.1, this optocoupler is suitable for "safe electrical insulation" only within the safety ratings. Compliance with the safety ratings shall be ensured by means of protective circuits.

**TYPICAL CHARACTERISTICS**

T<sub>amb</sub> = 25 °C, unless otherwise specified

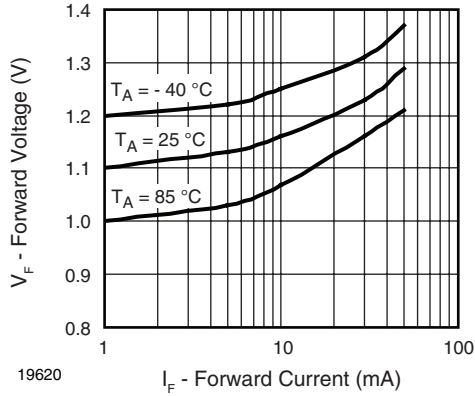

Fig. 1 - Forward Voltage vs. Forward Current

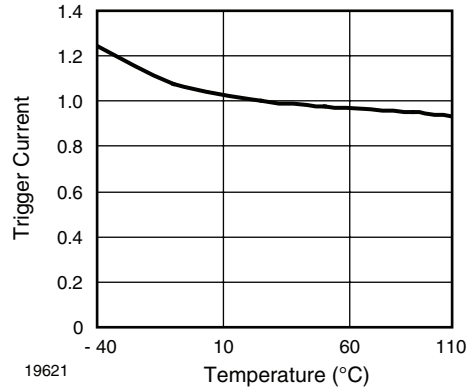

Fig. 4 - Normalized Trigger Current vs. Temperature

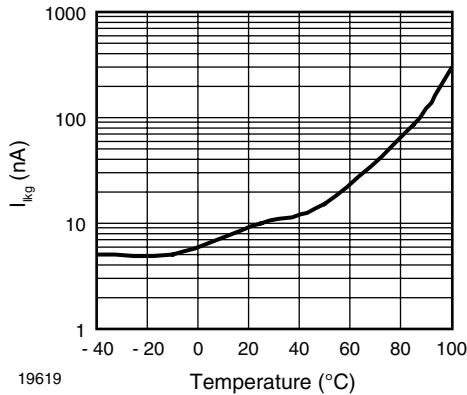

Fig. 2 - Off-State Leakage Current vs. Temperature

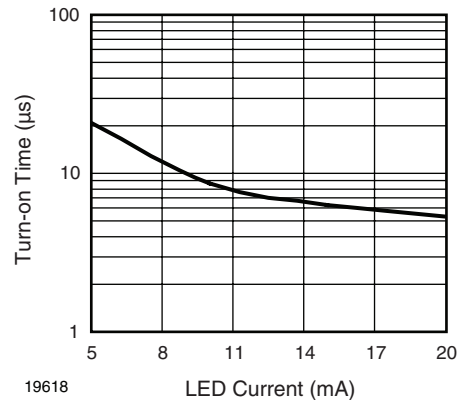

Fig. 5 - Turn-on Time vs. LED Current

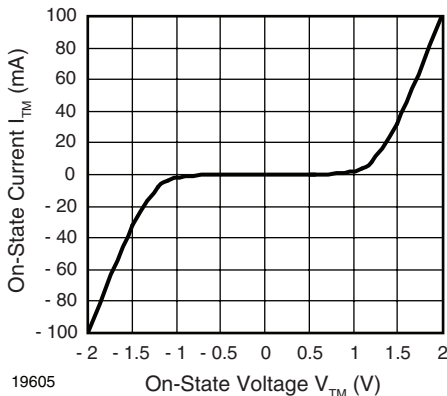

Fig. 3 - On-State Current vs. V<sub>TM</sub>

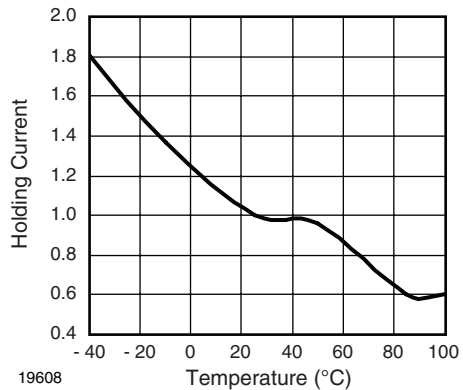

Fig. 6 - Normalized Holding Current vs. Temperature

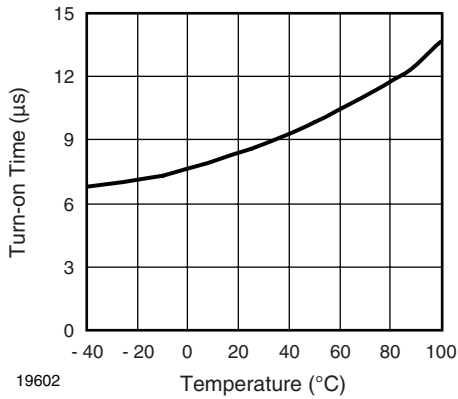

Fig. 7 - Turn-on Time vs. Temperature

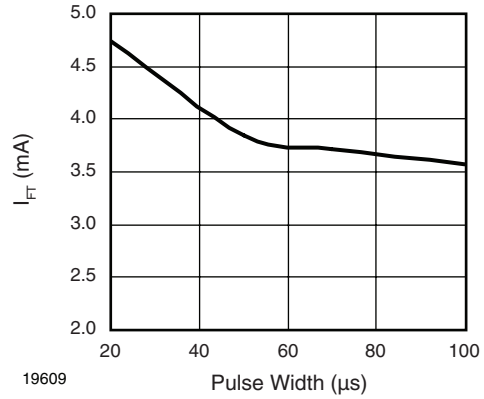
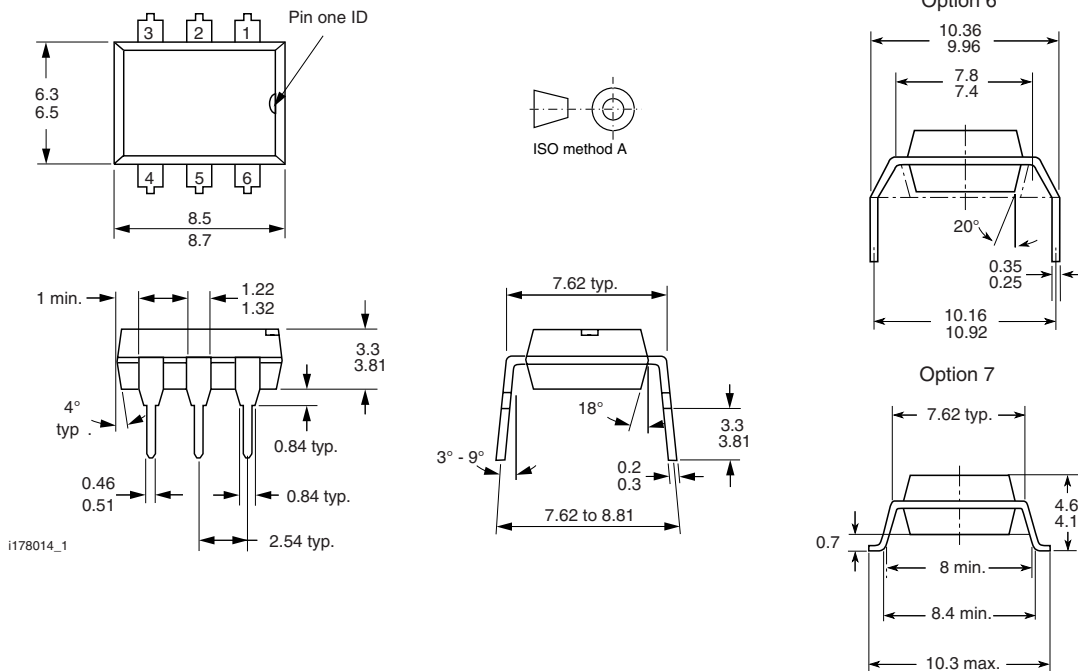
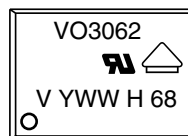

Fig. 8 - Trigger Current vs. Pulse Width

## PACKAGE DIMENSIONS in millimeters



## PACKAGE MARKING



21764-36



## Disclaimer

All product specifications and data are subject to change without notice.

Vishay Intertechnology, Inc., its affiliates, agents, and employees, and all persons acting on its or their behalf (collectively, "Vishay"), disclaim any and all liability for any errors, inaccuracies or incompleteness contained herein or in any other disclosure relating to any product.

Vishay disclaims any and all liability arising out of the use or application of any product described herein or of any information provided herein to the maximum extent permitted by law. The product specifications do not expand or otherwise modify Vishay's terms and conditions of purchase, including but not limited to the warranty expressed therein, which apply to these products.

No license, express or implied, by estoppel or otherwise, to any intellectual property rights is granted by this document or by any conduct of Vishay.

The products shown herein are not designed for use in medical, life-saving, or life-sustaining applications unless otherwise expressly indicated. Customers using or selling Vishay products not expressly indicated for use in such applications do so entirely at their own risk and agree to fully indemnify Vishay for any damages arising or resulting from such use or sale. Please contact authorized Vishay personnel to obtain written terms and conditions regarding products designed for such applications.

Product names and markings noted herein may be trademarks of their respective owners.