

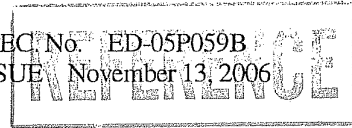

SPEC. No. ED-05P059B
ISSUE November 13, 2006



OPTO-ANALOG DEVICES DIVISION
ELECTRONIC COMPONENTS GROUP
SHARP CORPORATION

SPECIFICATION

DEVICE SPECIFICATION FOR

PHOTOCOUPLER

MODEL No. PC925L

Business dealing name

PC925L0NIP0F
PC925L0YIP0F

Specified for

Enclosed please find copies of the Specifications which consists of 17 pages including cover.
This specification sheets and attached sheets shall be both side copy.
After confirmation of the contents, please be sure to send back copies of the Specifications
with approving signature on each.

CUSTOMER'S APPROVAL

PRESENTED

DATE

DATE *Nov. 14, 2006*

BY

BY *H. Imanaka*

H. Imanaka,
Department General Manager of
Engineering Dept., II
Opto-Analog Devices Div.
ELECOM Group
SHARP CORPORATION

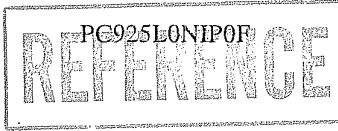

Product name : PHOTOCOUPLER

Model No. : PC925L

Business dealing name	Business dealing name
PC925L0NIP0F	PC925L0YIP0F

1. These specification sheets include materials protected under copyright of Sharp Corporation ("Sharp"). Please do not reproduce or cause anyone to reproduce them without Sharp's consent.
2. When using this product, please observe the absolute maximum ratings and the instructions for use outlined in these specification sheets, as well as the precautions mentioned below. Sharp assumes no responsibility for any damage resulting from use of the product which does not comply with the absolute maximum ratings and the instructions included in these specification sheets, and the precautions mentioned below.

(Precautions)

- (1) This product is designed for use in the following application areas ;

<ul style="list-style-type: none"> · OA equipment Audio visual equipment · Home appliances · Telecommunication equipment (Terminal) · Measuring equipment · Tooling machines · Computers

If the use of the product in the above application areas is for equipment listed in paragraphs (2) or (3), please be sure to observe the precautions given in those respective paragraphs.
- (2) Appropriate measures, such as fail-safe design and redundant design considering the safety design of the overall system and equipment, should be taken to ensure reliability and safety when this product is used for equipment which demands high reliability and safety in function and precision, such as ;

<ul style="list-style-type: none"> · Transportation control and safety equipment (aircraft, train, automobile etc.) · Traffic signals · Gas leakage sensor breakers · Rescue and security equipment · Other safety equipment

- (3) Please do not use this product for equipment which require extremely high reliability and safety in function and precision, such as ;

<ul style="list-style-type: none"> · Space equipment · Telecommunication equipment (for trunk lines) · Nuclear power control equipment · Medical equipment

- (4) Please contact and consult with a Sharp sales representative if there are any questions regarding interpretation of the above three paragraphs.

3. Please contact and consult with a Sharp sales representative for any questions about this product.

1. Application

This specification applies to the outline and characteristics for OPIC type photocoupler PC925L(Lead-Free Type) for IGBT or MOS-FET Gate Drive.

- 2. Outline Refer to the attached sheet, page 3.
- 3. Ratings and characteristics Refer to the attached sheet, page 4 to 7.
- 4. Reliability Refer to the attached sheet, page 8.
- 5. Outgoing inspection Refer to the attached sheet, page 9.

6. Supplement

- 6.1 Isolation voltage shall be measured in the following method.
 - (1) Short between pins 1 and 4 on the primary side and between pins 5 and 8 on the secondary side.
 - (2) The dielectric withstanding tester with zero-cross circuit shall be used.
 - (3) The wave form of applied voltage shall be a sine wave.

6.2 Business dealing name

("○" mark indicates business dealing name of ordered product)

Product	Business dealing name	Remark
	PC925LONIP0F	
	PC925L0YIP0F	Applied to product as a option (Attachment-2-1 to 2-3.)

6.3 The block diagram, Truth table

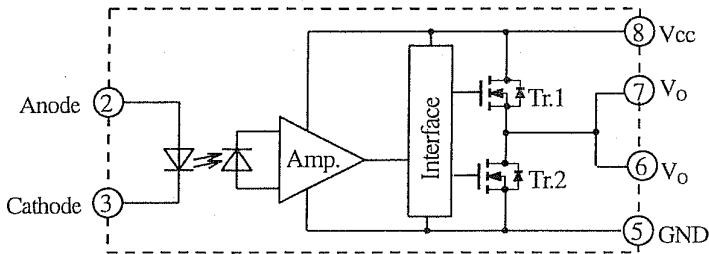

Input	V _O Output	Tr.1	Tr.2
ON	High level	ON	OFF
OFF	Low level	OFF	ON

6.4 Package specification Refer to the attached sheet, page 10, 11.

6.5 This Model is approved by UL.
Approved Model No. : PC925L
UL file No. : E64380

6.6 This product is not designed against irradiation.
This product is assembled with electrical input and output.
This product incorporates non-coherent light emitting diode.

6.7 ODS materials

This product shall not contain the following materials.

Also, the following materials shall not be used in the production process for this product.

Materials for ODS : CFCs, Halon, Carbon tetrachloride, 1.1.1-Trichloroethane (Methyl chloroform)

6.8 Specified brominated flame retardants

Specified brominated flame retardants (PBB and PBDE) are not used in this device at all.

7. Notes

Precautions for photocouplers : Attachment-1

2. Outline

PC925L
S

Primary side mark

Rank mark *2

Date code *1

Pin-Number and internal connection diagram

V_{CC} V_O V_O GND
⑧ ⑦ ⑥ ⑤

① N.C. ② Anode ③ Cathode ④ N.C.

9.66 ±0.30

3.5 ±0.5

2.54 ±0.25

7.62 ±0.30

0.26 ±0.10

0.35 ±0.25

Epoxy resin

1.0^{+0.4}₀

10.0⁺⁰_{0.5}

1.0^{+0.4}₀

1st week	1
2nd week	2
3rd week	3
4th week	4
5th and 6th week	5

Date code

Weekly code

2-digit indication according to OLD DIN standard.

*1) As shown in the left drawing, Date code consists of 2-digit indication according to OLD DIN standard and the weekly code.

*2) Rank mark shall be or shall not be marked

Pin material : Copper Alloy
Pin finish : Palladium (Au flash plating)

Product mass: Approx. 0.51g

UNIT : 1/1 mm

Name	PC925L Outline Dimensions (Business dealing name : PC925L0NIP0F)
------	---------------------------------------------------------------------

Marking is laser marking

3. Ratings and characteristics

3.1 Absolute maximum ratings

Ta=25°C

Parameter		Symbol	Rating	Unit
Input	*1 Forward current	I_F	25	mA
	Reverse voltage	V_R	5	V
	*4 Peak forward current	I_{FM}	1	A
Output	Supply voltage	V_{CC}	35	V
	*5 Peak output current	$I_{O(PEAK)}$	2.5	A
	Output voltage	V_O	V_{CC}	V
	*2 Power dissipation	P_O	250	mW
*3 Total power dissipation		P_{tot}	295	mW
*6 Isolation voltage		$V_{iso(ms)}$	5.0	kV
Operating temperature		T_{opr}	-40 to +100	°C
Storage temperature		T_{stg}	-55 to +125	°C
Soldering temperature		T_{sol}	270 (For 10s)	°C

*1 When ambient temperature goes above 70°C, the forward current goes down at the rate of 0.3mA/°C. (Fig. 10)

*2 When ambient temperature goes above 70°C, the forward current goes down at the rate of 4.8mW/°C. (Fig. 11)

*3 When ambient temperature goes above 70°C, the forward current goes down at the rate of 5.4mW/°C. (Fig. 12)

The maximum LED junction temperature should not exceed 125°C

*4 Pulse width $\leq 1 \mu s, 300pps$

*5 Pulse width $\leq 10 \mu s$, Duty ratio : 0.002

*6 AC for 1 min, 40 to 60%RH, Ta=25°C

3.2 Electro-optical characteristics *7 *13

(Unspecified : Ta=-40 to +100°C, I_{F(ON)}=7 to 16mA, V_{CC}=15 to 30V, V_{F(OFF)}= -3 to 0.8V)

Parameter		Symbol	MIN.	TYP.	MAX.	Unit	Test circuit	Conditions	
Input	Forward voltage	V _F	1.2	-	1.8	V	-	I _F =10mA	
	Reverse current	I _R	-	-	10	μA	-	V _R =5V	
	Terminal capacitance	C _t	-	60	150	pF	-	Ta=25°C, V=0, f=1MHz	
Output	High level output current	I _{OH}	0.5	1.5	-	A	(1)	V _O =(V _{CC} -4V), I _{F(ON)} *8	
			2.0	-	-	A		V _O =(V _{CC} -15V), I _{F(ON)} *9	
	Low level output current	I _{OL}	0.5	1.5	-	A	(2)	V _O =2.5V, V _{F(OFF)} *8	
			2.0	-	-	A		V _O =15V, V _{F(OFF)} *9	
	High level output voltage	V _{OH}	V _{CC} -4	V _{CC} -3	-	V	(3)	I _O =0.1A, I _{F(ON)}	
	Low level output voltage	V _{OL}	-	0.1	0.5	V	(4)	I _O =0.1A, V _{F(OFF)}	
	High level supply current *10	I _{CCH}	-	2.5	5.0	mA	(5)	I _{F(ON)}	
	Low level supply current *10	I _{CCL}	-	2.5	5.0	mA		V _{F(OFF)}	
	UVLO Threshold	V _{UVLO+}	11.0	12.3	13.5	V	(6)	V _O >5V, I _F =10mA	
			9.5	10.7	12.0	V			
UVLO Hysteresis	UVLO _{HYS}	-	1.6	-	V				
Transfer characteristics	"L→H" threshold input current *11	I _{FLH}	-	-	5.0	mA	(7)	V _O >5V, I _O =0	
	Isolation resistance	R _{ISO}	5×10 ¹⁰	10 ¹¹	-	Ω	-	Ta=25°C, DC=500V, 40 to 60%RH	
	Response time	"L→H" propagation delay time	t _{PLH}	0.1	0.3	0.5	μs	(8)	R _G =10Ω, C _G =10nF f=10kHz, Duty ratio 50%
		"H→L" propagation delay time	t _{PHL}	0.1	0.3	0.5			
		Distortion of pulse width *12	Δt _w	-	-	0.3			
		Propagation delay skew	t _{PSK}	-0.35	-	0.35			
		Rise time	t _r	-	0.1	-			
		Fall time	t _f	-	0.1	-			
		UVLO turn on delay	t _{UVLO ON}	-	0.8	-			
		UVLO turn off delay	t _{UVLO OFF}	-	0.6	-			
	Instantaneous common mode rejection voltage (High level output)	CM _H	15	-	-	kV/μs	(9)	Ta=25°C, V _{CM} =1.5kV(p-p) I _F =10 to 16mA, V _{CC} =30V V _{OH} >15V	
Instantaneous common mode rejection voltage (Low level output)	CM _L	15	-	-	Ta=25°C, V _{CM} =1.5kV(p-p) V _F =0, V _{CC} =30V V _{OL} <1.0V				

*7 It is necessary connecting a by-pass capacitor of 0.1 μF or more between V_{CC} (Pin No. 8) and GND (Pin No. 5) near the device, when measuring the transfer characteristics and the output side characteristics.

*8 Pulse width ≤ 50 μs, Duty ratio : 0.005

*9 Pulse width ≤ 10 μs, Duty ratio : 0.002

*10 Output pin is open.

*11 I_{FLH} is the value of forward current when output changes from "L" to "H".

*12 Pulse width Δt_w = |t_{PHL} - t_{PLH}|

*13 All typical values are at Ta=25°C, V_{CC}=30V.

Test circuit

(Fig.1)

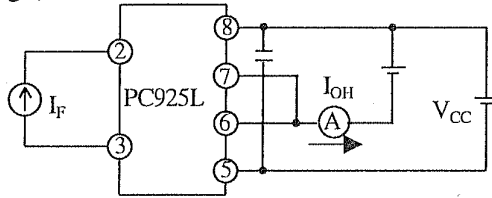

(Fig.2)

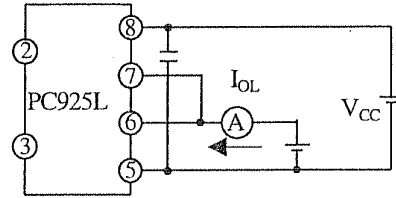

(Fig.3)

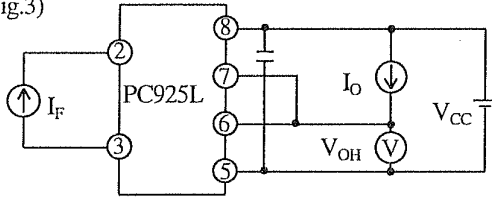

(Fig.4)

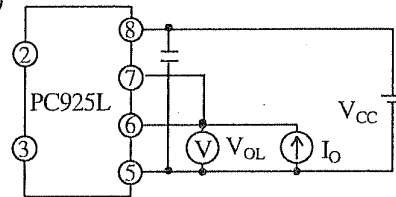

(Fig.5)

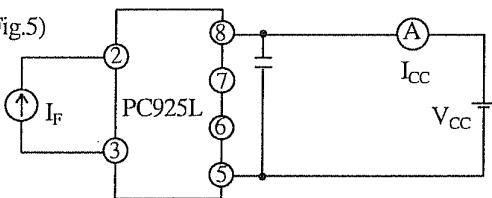

(Fig.6)

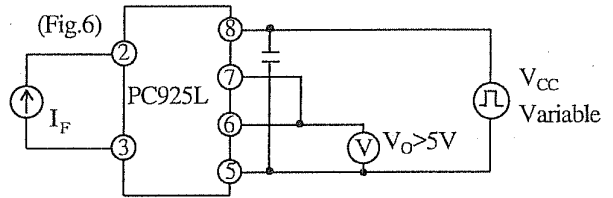

(Fig.7)

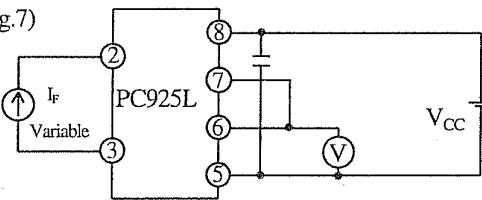

(Fig.8)

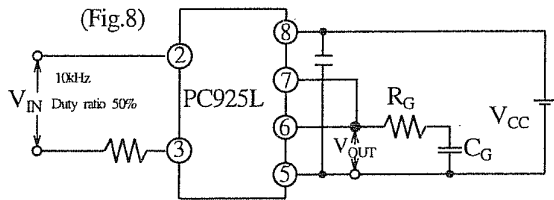

(Fig.9)

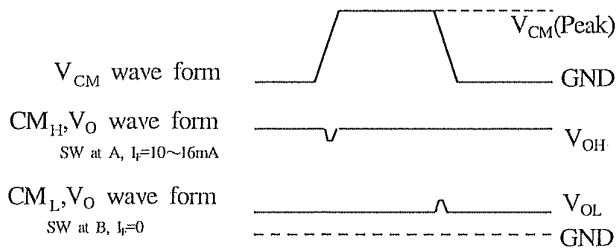
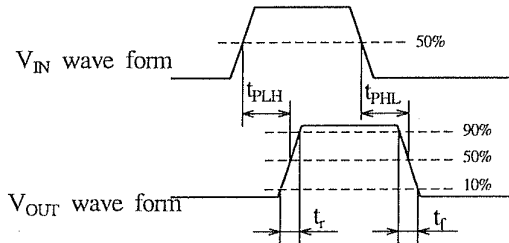
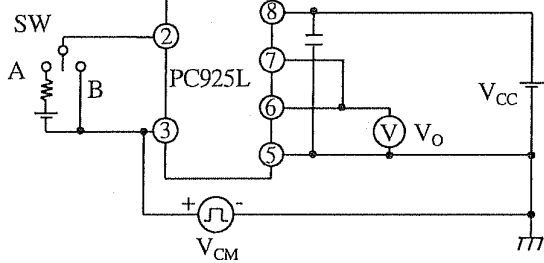

(Fig.10) Forward current vs. ambient temperature

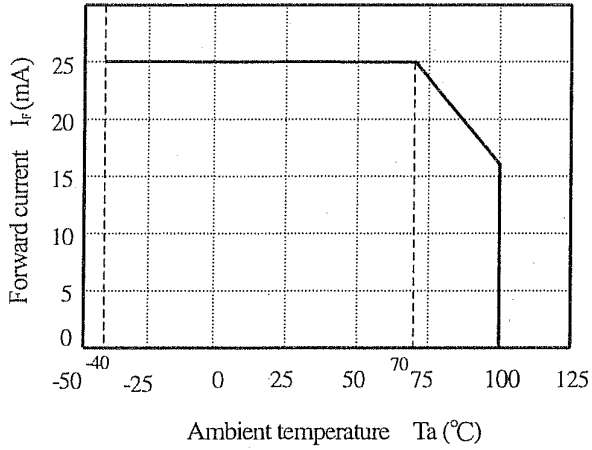

(Fig.11) Output power dissipation vs. ambient temperature

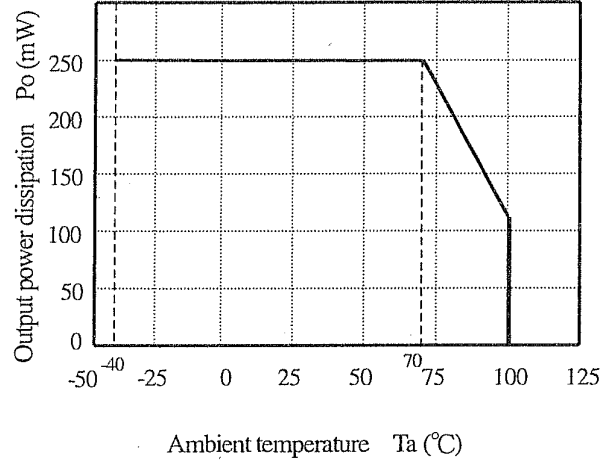

(Fig. 12) Total power dissipation vs. ambient temperature

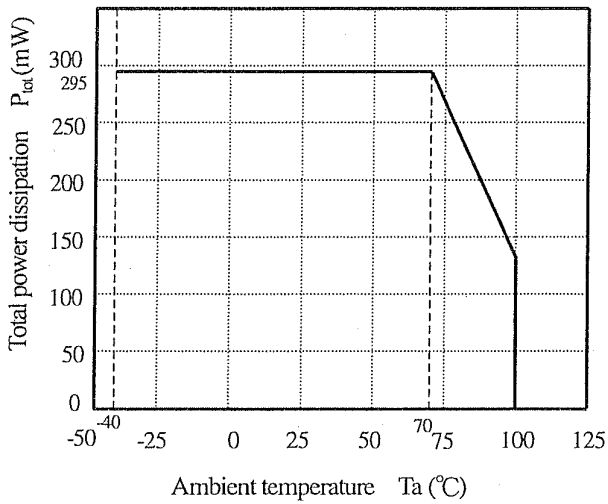

4. Reliability

The reliability of products shall satisfy items listed below.

Confidence level : 90%

LTPD : 10 or 20

Test Items	Test Conditions *1	Failure Judgment Criteria	Samples (n)
			Defective (C)
Solderability *2	245±3°C, 5 s	$V_F > U \times 1.2$ $I_R > U \times 2$ $V_{OL} > U \times 1.2$ $V_{OH} < L \times 0.8$ $I_{CCH} > U \times 1.2$ $I_{CCL} > U \times 1.2$ $I_{FLH} > U \times 1.3$ U: Upper specification limit L: Lower specification limit	n=11, C=0
Soldering heat	(Flow soldering) 270 °C, 10 s		n=11, C=0
	(Soldering by hand) 400°C, 3 s		n=11, C=0
Terminal strength (Tension)	Weight: 5N, 5 s/each terminal		n=11, C=0
Terminal strength (Bending) *3	Weight: 2.5N, 2 times/each terminal		n=11, C=0
Mechanical shock	15km/s ² , 0.5ms 3 times/±X, ±Y, ±Z direction		n=11, C=0
Variable frequency vibration	100 to 2000 to 100Hz/4 min 200m/s ² 4 times/X, Y, Z direction		n=11, C=0
Temperature cycling	1 cycle -55 °C to +125 °C (30 min) (30 min) 20 cycles test		n=22, C=0
High temp. and high humidity storage	+85°C, 85%RH, 1000h		n=22, C=0
High temp. storage	+125 °C, 1000h		n=22, C=0
Low temp. storage	- 55 °C, 1000h		n=22, C=0
Operation life	I _F =25mA, V _{CC} =30V T _a =25 °C, 1000h		n=22, C=0

*1 Test method, conforms to EIAJ ED 4701.

*2 Solder shall adhere at the area of 95% or more of immersed portion of lead, and pin hole or other holes shall not be concentrated on one portion.

*3 Terminal bending direction is shown below.

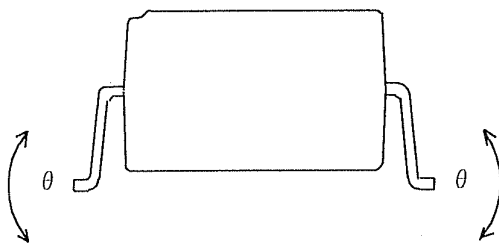

5. Outgoing inspection

5.1 Inspection items

(1) Electrical characteristics

$V_F, I_R, V_{OH}, V_{OL}, I_{CCH}, I_{CCL}, I_{FLH}, R_{ISO}, V_{ISO}$

(2) Appearance

5.2 Sampling method and Inspection level

A single sampling plan, normal inspection level II based on ISO 2859 is applied.

The AQL according to the inspection items are shown below.

Defect	Inspection item	AQL (%)
Major defect	Electrical characteristics Unreadable marking	0.065
Minor defect	Appearance defect except the above mentioned.	0.25

6.4 Package specifications

6.4.1 Taping conditions

- (1) Tape structure and Dimensions (Refer to the attached sheet, Page 10)
The carrier tape has the heat pressed structure of A-PET material carries tape of protected against static electricity and three layers cover tape (PET material base).
- (2) Reel structure and Dimensions (Refer to the attached sheet, Page 11)
The taping reel shall be of plastic (PS material).
- (3) Direction of product insertion (Refer to the attached sheet, Page 11)
- (4) Joint of tape
The cover tape and carrier tape in one reel shall be joint less.
- (5) To repair failure-taped devices, cutting a bottom of carrier tape with a cutter.
After replacing the cut portion shall be sealed with adhesive tape.

6.4.2 Adhesiveness of cover tape

The exfoliation force between carrier tape and cover tape shall be 0.2N to 0.7N for the angle 160° to 180° .

6.4.3 Rolling method and quantity

Wind the tape back on the reel so that the cover tape will be outside the tape.
Attach more than 20cm of blank tape to the trailer and the leader of the tape and fix the both ends with adhesive tape.
One reel basically shall contain 1000pcs.

6.4.4 Outer packing appearance (Refer to attached sheet, Page 11)

6.4.5 Marking

The label with following information shall be pasted at appointed place of the outer packing case.

- * Model No. *(Business dealing name) * Lot No. * Quantity
- * country of origin *Company name *inspection date specified

6.4.6 Storage condition

Taped products shall be stored at the temperature 5 to 30°C and the humidity 70%RH or less away from direct sunlight.

6.4.7 Safety protection during shipping

There shall be no deformation of component or degradation of electrical characteristics due to shipping.

Carrier tape structure and Dimensions

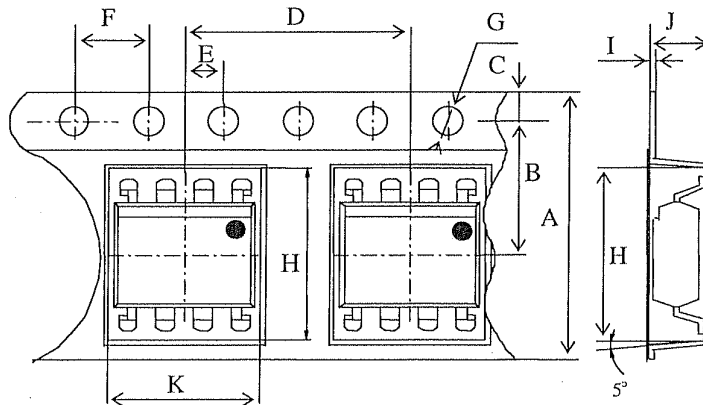

Dimensions list (Unit : mm)

A	B	C	D	E	F	G	H	I	J	K
±0.3	±0.1	±0.10	±0.1	±0.1	±0.1	+0.1 -0	±0.1	±0.05	±0.10	±0.1
16.0	7.5	1.75	12.0	2.0	4.0	φ 1.5	10.4	0.40	4.20	10.2

Reel structure and Dimensions

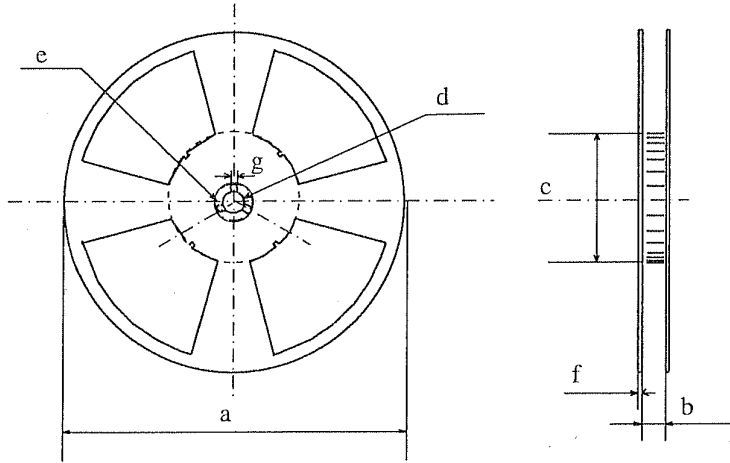

Dimensions list (Unit : mm)

a	b	c	d
330	17.5±1.5	φ 100.0±1.0	φ 13.0±0.5
e	f	g	
φ 23.0±1.0	2.0±0.5	2.0±0.5	

Direction of product insertion

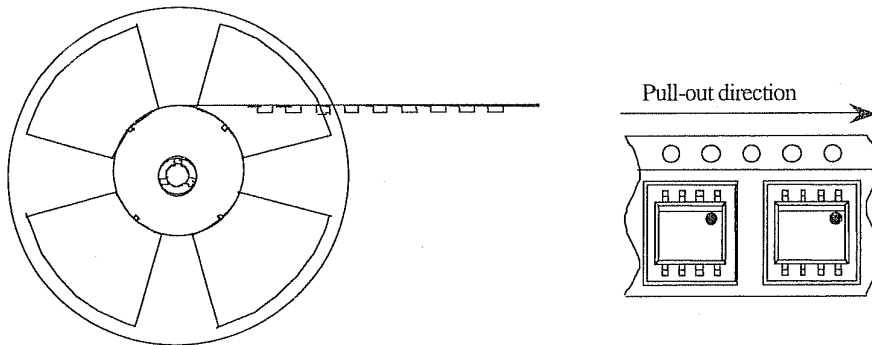

Outer packing appearance

- (1) Carrier tape with 1,000pcs. of the devices (reeled) are packed in packing case.
- (2) The packing case is sealed by kraft tape & the label is placed on it.
 (Max. 4 reels are packed in one carton (Max. 4,000pcs of devices are in one carton))

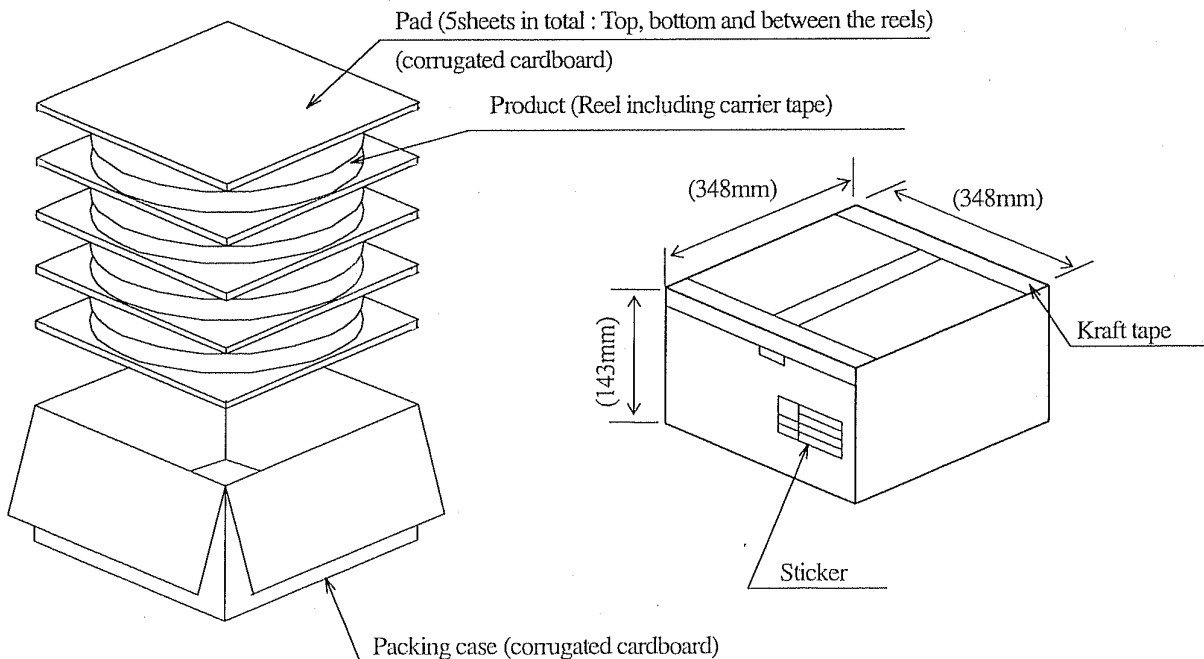

Regular packing mass : Approx. 4kg
 Dimensions : Reference dimensions

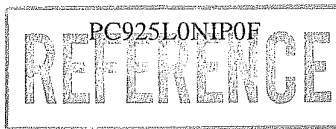

Precautions for Photocouplers

1. Recommended operating conditions

Parameter	Symbol	MIN.	TYP.	MAX.	Unit
Forward current (ON)	$I_{F(ON)}$	7	-	16	mA
Forward voltage (OFF)	$V_{F(OFF)}$	-3.0	-	0.8	V
Supply voltage	V_{CC}	15	-	30	V
Operating temperature	T_{opr}	-40	-	100	°C

To ensure the reliability sufficiently, please design the circuit with considering the decreases of the light emission power of the LED.

2. Cleaning

- (1) Solvent cleaning : Solvent temperature 45°C or less, Immersion for 3 min or less
- (2) Ultrasonic cleaning : The effect to device by ultrasonic cleaning differs by cleaning bath size, ultrasonic power output, cleaning time, PCB size or device mounting condition etc.
Please test it in actual using condition and confirm that any defect doesn't occur before starting the ultrasonic cleaning.
- (3) Applicable solvent : Ethyl alcohol, Methyl alcohol, Isopropyl alcohol
When the other solvent is used, there are cases that the packaging resin is eroded.
Please use the other solvent after thorough confirmation is performed in actual using condition.

3. Static electricity

This product consist of bipolar and CMOS type device in output side and is susceptible to static electricity due to its minute design. When handling them, general countermeasure against static electricity should be taken to avoid breakdown of devices or degradation of characteristics.

4. Circuit design

- 4.1 In order to stabilize power supply line, please certainly connect a by-pass capacitor of 0.1 μ F or more between Vcc and GND near the device.
- 4.2 When steep voltage noise is applied between the primary side and the secondary side of the photocoupler, current flows or changes in the light emitting diode through a parasitic capacitance between the primary side and the secondary side of the photocoupler, then there is a case that miss operation occurs depending upon the applied noise level. We should certainly recommend to use a by-pass capacitor between both terminals of the light emitting diode when used in noisy environment.
- 4.3 The detector which is used in this device has parasitic diode between each pins and GND.
There are cases that miss operation or destruction may be occurred if electric potential of any pin fall below GND level in an instant.
Therefore it shall be recommended to design the circuit that electric potential of any pin does not become below GND level.
- 4.4 The LED used in the Photocoupler generally decreases the light emission power by operation. In case of long operation time, please design the circuit with considering the decreases of the light emission power of the LED. (50%/5years)
Please decide the input current so that it become 2 times of MAX. I_{FLH} .

5. Precautions for Soldering

- (1) In the case of flow soldering (Whole dipping is possible.)

It is recommended that flow soldering should be at 270°C or less for 10 s or less (Pre-heating : 100 to 150°C, 30 to 80s).
 (2 times or less)

- (2) If solder reflow :

It is recommended to be done at the temperature and the time within the temperature profile as shown in the figure below. (2 times or less)

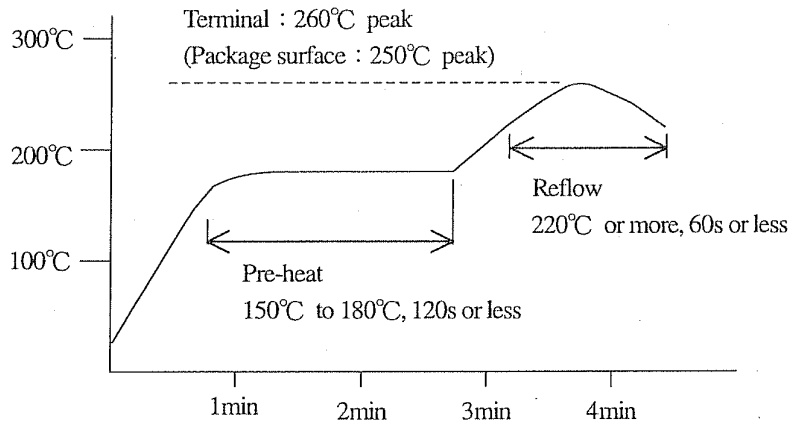

- (3) In the case of hand soldering

What is done on the following condition is recommended.(2 times or less)

Soldering iron temperature : 400°C or less

Time : 3s or less

- (4) Other precautions

Depending on equipment and soldering conditions (temperature, Using solder etc.),
 the effect to the device and the PCB is different.

Please confirm that there is no problem on the actual use conditions in advance.



1. This specification shall be applied to photocoupler, Model No. PC925L as an option.

2. Applicable Models (Business dealing name)
PC925L0YIP0F

3. The relevant models are the models Approved by VDE according to DIN EN 60747-5-2.

Approved Model No. : PC925L

VDE approved No. : 40008898 (According to the specification DIN EN60747-5-2)

- Operating isolation voltage U_{IORM} : 890V (Peak)
- Transient voltage : 7100V (Peak)
- Pollution : 2
- Clearances distance (Between input and output) : 6.4mm (MIN.)
- Creep age distance (Between input and output) : 6.4mm (MIN.)
- Isolation thickness between input and output : 0.15mm (MIN.)
- Tracking-proof : CTI 175
- Safety limit values
 - Current (Isi) : 200mA (Diode side)
 - Power (Psi) : 687mW (OPIC side)
 - Temperature (Tsi) : 150°C

In order to keep safety electric isolation of photocoupler, please set the protective circuit to keep within safety limit values when the actual application equipment troubled.

- Indication of VDE approval "  " is printed on minimum unit package.

4. Outline Refer to the attachment-2-2.

5. Isolation specification according to EN60747-5-2

Parameter	Symbol	Condition	Rating	Unit	Remark								
Class of environmental test	-	-	55/100/21	-									
Pollution	-	-	2	-									
Maximum operating isolation voltage	$U_{IORM(PEAK)}$	-	890	V	Refer to the Diagram 1,2 (Attachement-2-3)								
Partial discharge test voltage (Between input and output)													
<table border="1" style="width: 100%;"> <tr> <td>Diagram 1</td> <td rowspan="2">$U_{pr(PEAK)}$</td> <td>$t_p=10s, q_c \leq 5pC$</td> <td>1340</td> <td>V</td> </tr> <tr> <td>Diagram 2</td> <td>$t_p=1s, q_c \leq 5pC$</td> <td>1670</td> <td>V</td> </tr> </table>	Diagram 1	$U_{pr(PEAK)}$	$t_p=10s, q_c \leq 5pC$	1340		V	Diagram 2	$t_p=1s, q_c \leq 5pC$	1670	V			
Diagram 1	$U_{pr(PEAK)}$		$t_p=10s, q_c \leq 5pC$	1340	V								
Diagram 2		$t_p=1s, q_c \leq 5pC$	1670	V									
Maximum over-voltage	$U_{IOTM(PEAK)}$	$t_{IN}=60s$	7100	V									
Safety maximum ratings					Refer to Fig. 13,14 (Attachement-2-3)								
1) Case temperature	Tsi	$I_F=0, P_C=0$	150	°C									
2) Input current	Isi	$P_C=0$	200	mA									
3) Electric power (Output or Total power dissipation)	Psi	-	687	mW									
Isolation resistance (Test voltage between input and output ; DC500V)	R_{ISO}			Ω									
		$T_a=T_{si}$	$MIN.10^9$										
		$T_a=T_{opr}(MAX.)$	$MIN.10^{11}$										
		$T_a=25^\circ C$	$MIN.10^{12}$										

6. Precautions in performing isolation test

6.1 Partial discharge test methods shall be the ones according to the specifications of EN 60747-5-2

6.2 Please don't carry out isolation test (V_{iso}) over U_{IOTM} .

This product deteriorates isolation characteristics by partial discharge due to applying high voltage (ex. U_{IOTM}).

And there is possibility that partial discharge occurs in operating isolation voltage. (U_{IORM}).

4. Outline

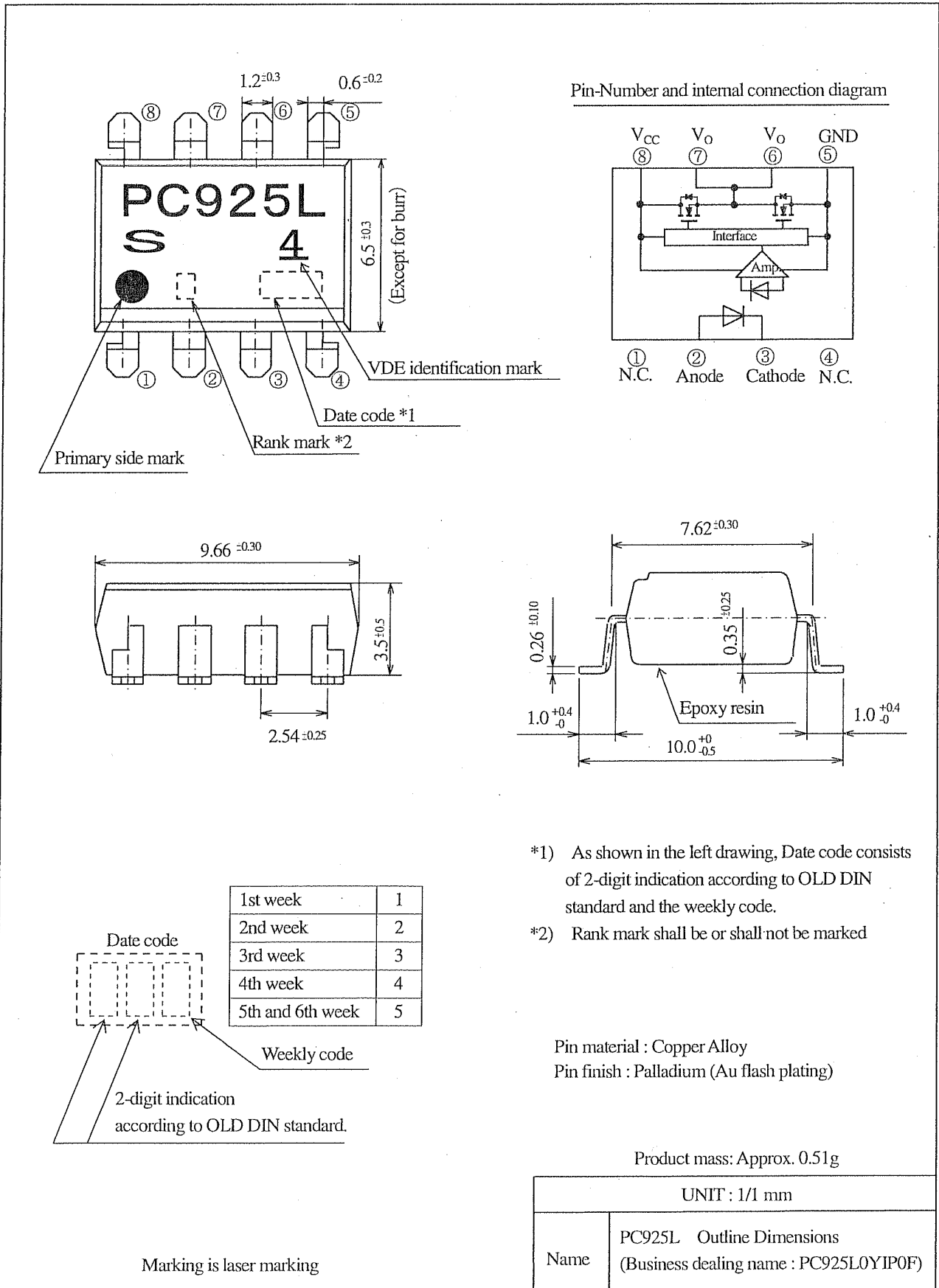

- *1) As shown in the left drawing, Date code consists of 2-digit indication according to OLD DIN standard and the weekly code.
- *2) Rank mark shall be or shall not be marked

Method of Diagram 1: Breakdown test (Apply to tape test and sampling test)

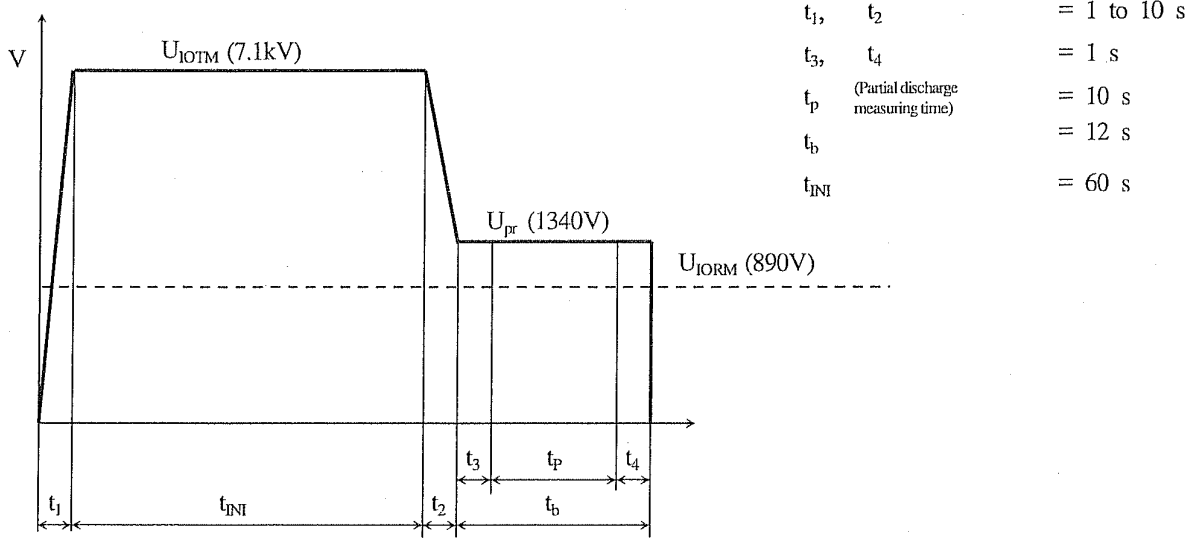

Method of Diagram 2: Non breakdown test (Apply to all device test)

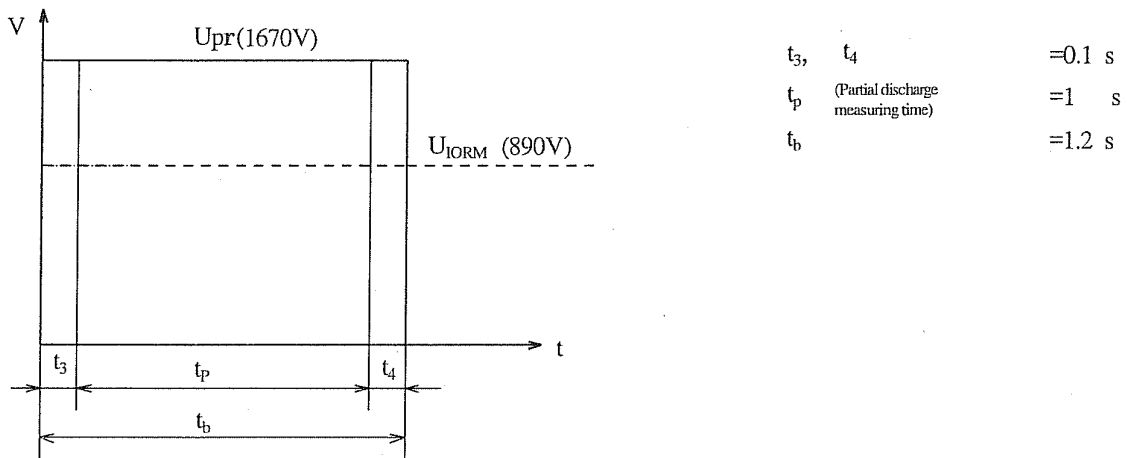

(Fig.13) Safety maximum power dissipation vs. ambient temperature (When failed)

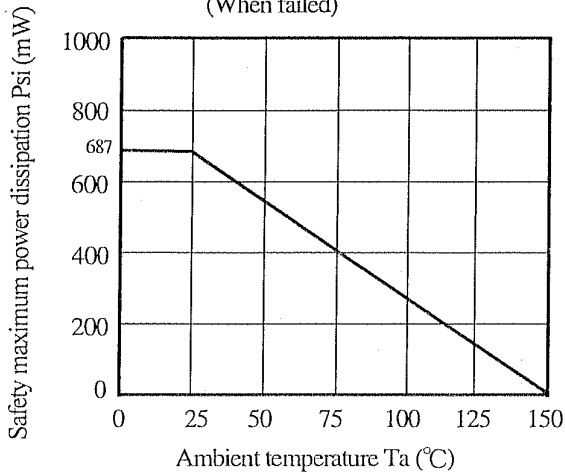

(Fig.14) Safety maximum forward current vs. ambient temperature (When failed)

