

## Ambient Light Sensor

### Description

TEMT6000 ambient light sensor plays a key role in power savings strategies by controlling LCD display intensity and keypad backlighting of mobile devices and in industrial on/off-lighting operation. It is sensitive to visible light much like the human eye and has peak sensitivity at 570 nm. TEMT6000 has analog output and is packaged in a small surface mount package.

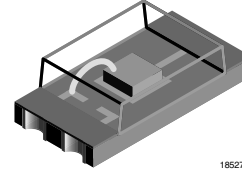

### Features

- High sensitivity,  $I_{PCE} = 50 \mu A$  ( $E_V = 100 \text{ lx}$ )
- Adapted to human eye responsivity
- Wide angle of half sensitivity  $\varphi = \pm 60^\circ$
- Surface mount package:  
H 1 mm x L 4 mm x W 2 mm
- Suitable for IR reflow soldering (Sn or SnPb)
- Lead (Pb)-free component
- Component in accordance with RoHS 2002/95/EC and WEEE 2002/96/EC



### Applications

Ambient light sensor for control of display backlight dimming in LCD displays and keypad backlighting of mobile devices and in industrial on/off-lighting operation.

- Mobile phones
- Notebook computers
- PDA's
- Cameras
- Dashboards

### Absolute Maximum Ratings

$T_{amb} = 25^\circ C$ , unless otherwise specified

Parameter	Test condition	Symbol	Value	Unit
Collector emitter voltage		$V_{CEO}$	6	V
Emitter collector voltage		$V_{ECO}$	1.5	V
Collector current		$I_C$	20	mA
Total power dissipation	$T_{amb} \leq 55^\circ C$	$P_{tot}$	100	mW
Junction temperature		$T_j$	100	$^\circ C$
Operating temperature range		$T_{amb}$	- 40 to + 85	$^\circ C$
Storage temperature range		$T_{stg}$	- 40 to + 85	$^\circ C$
Soldering temperature	Reflow Profile Figure 7	$T_{sd}$	260	$^\circ C$
Thermal resistance junction/ambient		$R_{thJA}$	450	K/W

### Basic Characteristics

$T_{amb} = 25\text{ }^{\circ}\text{C}$ , unless otherwise specified

Parameter	Test condition	Symbol	Min	Typ.	Max	Unit
Collector emitter breakdown voltage	$I_C = 0.1\text{ mA}$	$V_{CEO}$	6			V
Collector dark current	$V_{CE} = 5\text{ V}, E = 0$	$I_{CEO}$		3	50	nA
Collector-emitter capacitance	$V_{CE} = 0\text{ V}, f = 1\text{ MHz}, E = 0$	$C_{CEO}$		16		pF
Collector light current	$E_v = 20\text{ lx}, \text{CIE illuminant A}, V_{CE} = 5\text{ V}$	$I_{PCE}$	3.5	10	16	$\mu\text{A}$
	$E_v = 100\text{ lx}, \text{CIE illuminant A}, V_{CE} = 5\text{ V}$	$I_{PCE}$		50		$\mu\text{A}$
Angle of half sensitivity		$\phi$		$\pm 60$		deg
Wavelength of peak sensitivity		$\lambda_p$		570		nm
Range of spectral bandwidth		$\lambda_{0.1}$		360 to 970		nm
Collector emitter saturation voltage	$E_v = 20\text{ lx}, \text{standard light A}, I_{PCE} = 1.2\text{ }\mu\text{A}$	$V_{CEsat}$		0.1		V

### Typical Characteristics

$T_{amb} = 25\text{ }^{\circ}\text{C}$ , unless otherwise specified

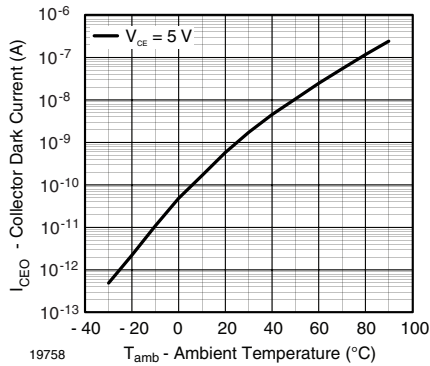

Figure 1. Collector Dark Current vs. Ambient Temperature

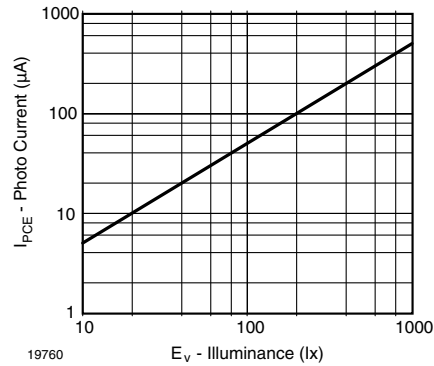

Figure 3. Photo Current vs. Illuminance

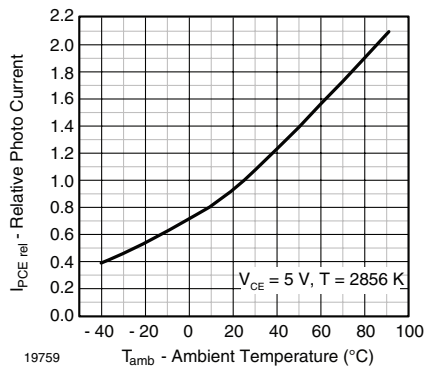

Figure 2. Relative Photo Current vs. Ambient Temperature

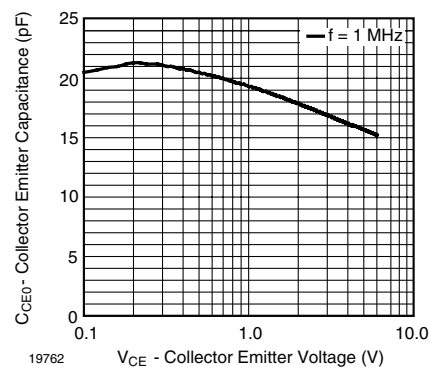

Figure 4. Collector Emitter Capacitance vs. Collector Emitter Voltage

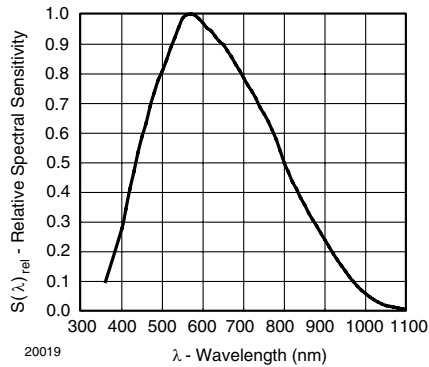

Figure 5. Relative Spectral Sensitivity vs. Wavelength

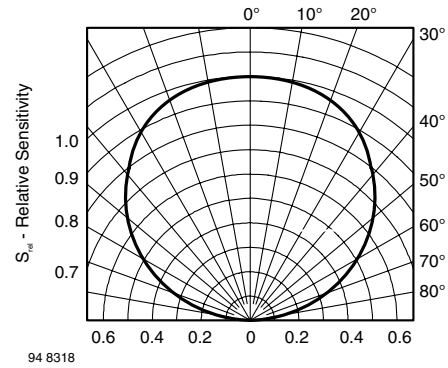

Figure 6. Relative Radiant Sensitivity vs. Angular Displacement

## Reflow Solder Profiles

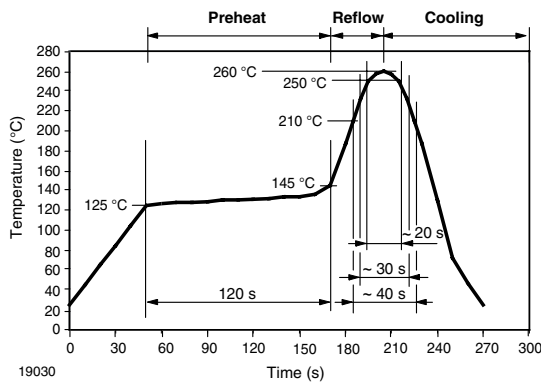

Figure 7. Tin (Sn) Reflow Solder Profile (Pb-free)

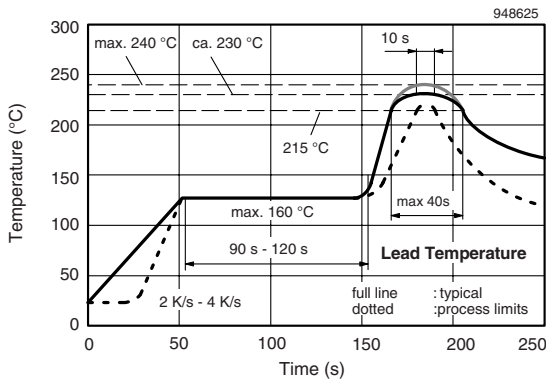

Figure 8. Lead Tin (SnPb) Reflow Solder Profile

## Drypack

Devices are packed in moisture barrier bags (MBB) to prevent the products from moisture absorption during transportation and storage. Each bag contains a desiccant.

## Floor Life

Floor life (time between soldering and removing from MBB) must not exceed the time indicated in J-STD-020. TEMT6000 is released for:

Moisture Sensitivity Level 4, according to JEDEC, J-STD-020

Floor Life: 72 h

Conditions:  $T_{amb} < 30\text{ }^{\circ}\text{C}$ ,  $\text{RH} < 60\%$

## Drying

In case of moisture absorption devices should be baked before soldering. Conditions see J-STD-020 or Label. Devices taped on reel dry using recommended conditions 192 h at  $40\text{ }^{\circ}\text{C}$  (+ 5  $^{\circ}\text{C}$ ),  $\text{RH} < 5\%$

## Package Dimensions

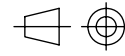
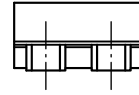
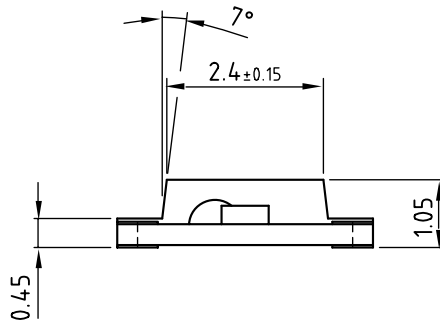

Technical drawings according to DIN specifications

All dimensions in mm

Not indicated tolerances  $\pm 0.1$

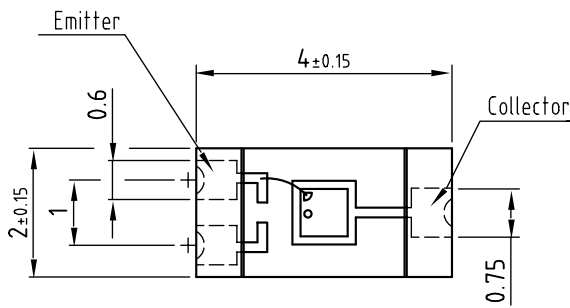

Recommended solder pad Footprint

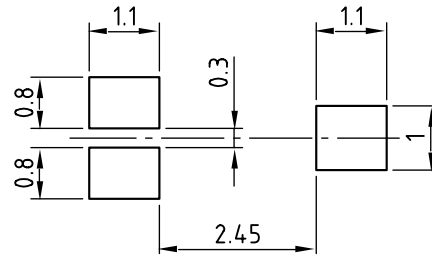

18464

Drawing-No.: 6.541-5053.01-4  
Issue: 2; 21.06.04



## Ozone Depleting Substances Policy Statement

It is the policy of Vishay Semiconductor GmbH to

1. Meet all present and future national and international statutory requirements.
2. Regularly and continuously improve the performance of our products, processes, distribution and operating systems with respect to their impact on the health and safety of our employees and the public, as well as their impact on the environment.

It is particular concern to control or eliminate releases of those substances into the atmosphere which are known as ozone depleting substances (ODSs).

The Montreal Protocol (1987) and its London Amendments (1990) intend to severely restrict the use of ODSs and forbid their use within the next ten years. Various national and international initiatives are pressing for an earlier ban on these substances.

Vishay Semiconductor GmbH has been able to use its policy of continuous improvements to eliminate the use of ODSs listed in the following documents.

1. Annex A, B and list of transitional substances of the Montreal Protocol and the London Amendments respectively
2. Class I and II ozone depleting substances in the Clean Air Act Amendments of 1990 by the Environmental Protection Agency (EPA) in the USA
3. Council Decision 88/540/EEC and 91/690/EEC Annex A, B and C (transitional substances) respectively.

Vishay Semiconductor GmbH can certify that our semiconductors are not manufactured with ozone depleting substances and do not contain such substances.

We reserve the right to make changes to improve technical design  
and may do so without further notice.

Parameters can vary in different applications. All operating parameters must be validated for each customer application by the customer. Should the buyer use Vishay Semiconductors products for any unintended or unauthorized application, the buyer shall indemnify Vishay Semiconductors against all claims, costs, damages, and expenses, arising out of, directly or indirectly, any claim of personal damage, injury or death associated with such unintended or unauthorized use.

Vishay Semiconductor GmbH, P.O.B. 3535, D-74025 Heilbronn, Germany



## Notice

Specifications of the products displayed herein are subject to change without notice. Vishay Intertechnology, Inc., or anyone on its behalf, assumes no responsibility or liability for any errors or inaccuracies.

Information contained herein is intended to provide a product description only. No license, express or implied, by estoppel or otherwise, to any intellectual property rights is granted by this document. Except as provided in Vishay's terms and conditions of sale for such products, Vishay assumes no liability whatsoever, and disclaims any express or implied warranty, relating to sale and/or use of Vishay products including liability or warranties relating to fitness for a particular purpose, merchantability, or infringement of any patent, copyright, or other intellectual property right.

The products shown herein are not designed for use in medical, life-saving, or life-sustaining applications. Customers using or selling these products for use in such applications do so at their own risk and agree to fully indemnify Vishay for any damages resulting from such improper use or sale.