

# SD3443/5443

Silicon Phototransistor

## SWITCHING TIME TEST CIRCUIT

cir\_03b.cdr

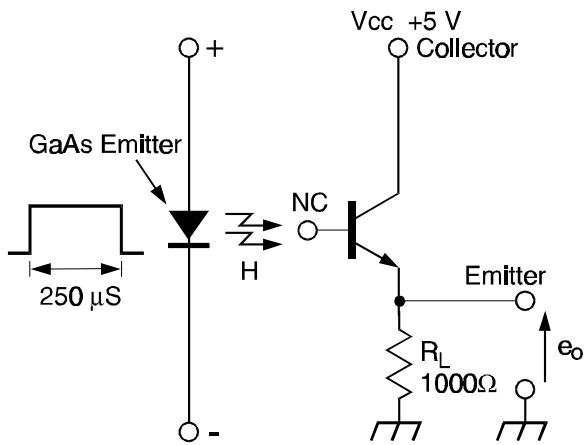

Fig. 1 Responsivity vs Angular Displacement (SD3443)

gra\_052.ds4

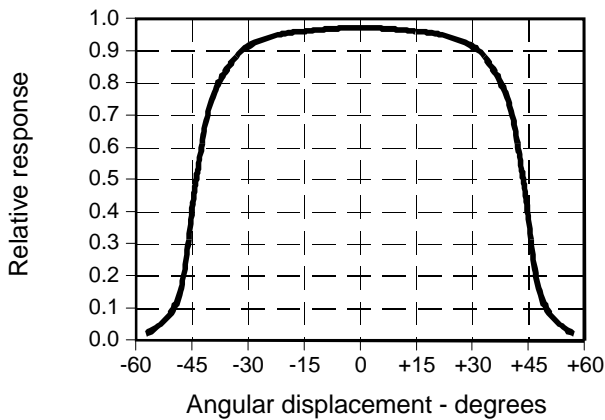
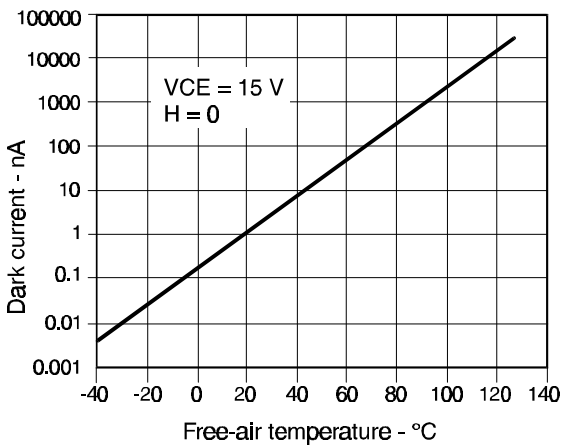

Fig. 3 Dark Current vs Temperature

gra\_303.cdr



## SWITCHING WAVEFORM

cir\_004.cdr

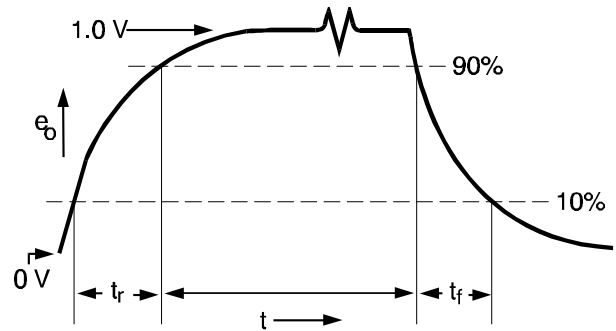

Fig. 2 Responsivity vs Angular Displacement (SD5443)

gra\_053.ds4

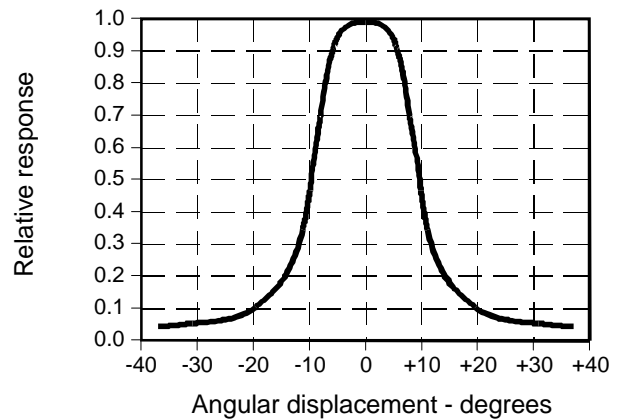
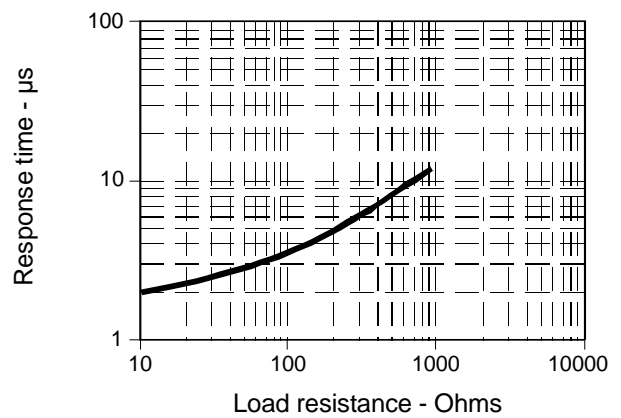

Fig. 4 Non-Saturated Switching Time vs Load Resistance

gra\_041.ds4



# SD3443/5443

## Silicon Phototransistor

Fig. 5 Spectral Responsivity

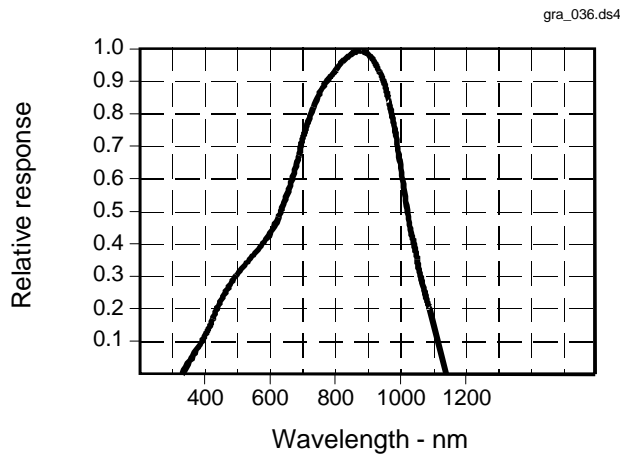

Fig. 6 Coupling Characteristics  
SE3450 with SD3443

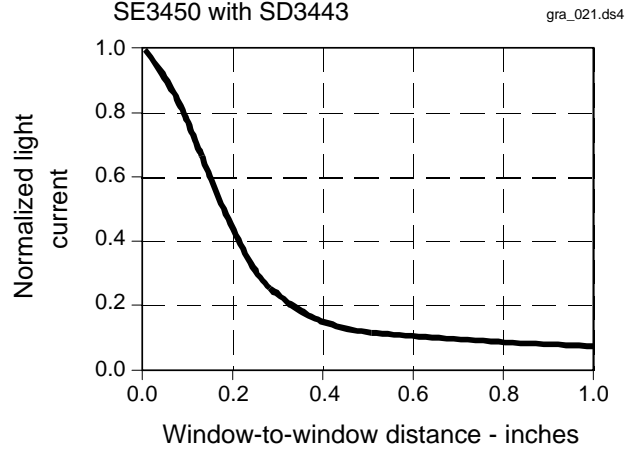

Fig. 7 Coupling Characteristics  
SE5450 with SD5443

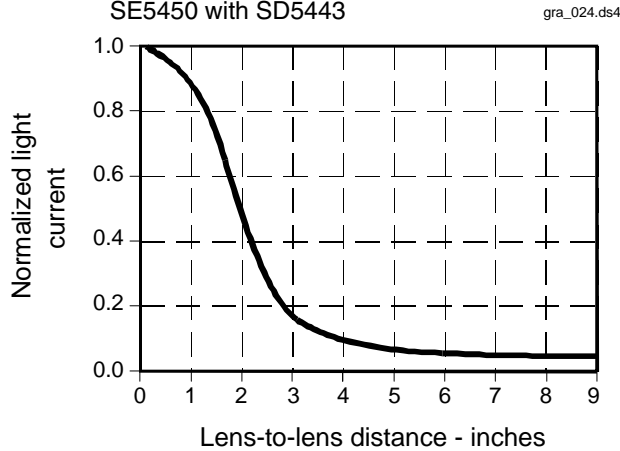
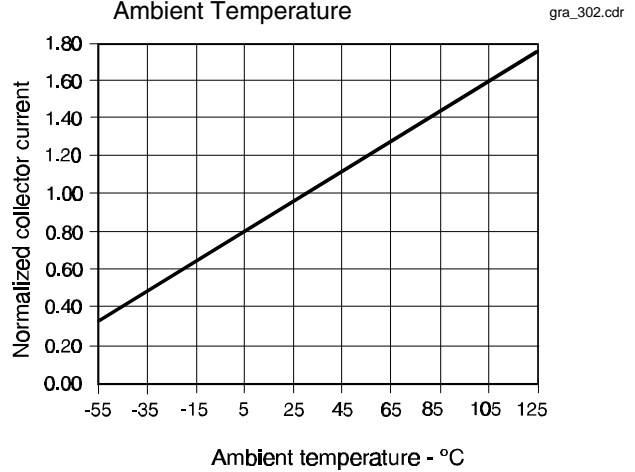

Fig. 8 Collector Current vs  
Ambient Temperature



All Performance Curves Show Typical Values