

Silicon Photo Darlington in PLCC-2 Package

OP580DA

Features:

- Wide acceptance angle
- High Current Gain
- Fast Response Time
- Plastic leadless chip carrier (PLCC)

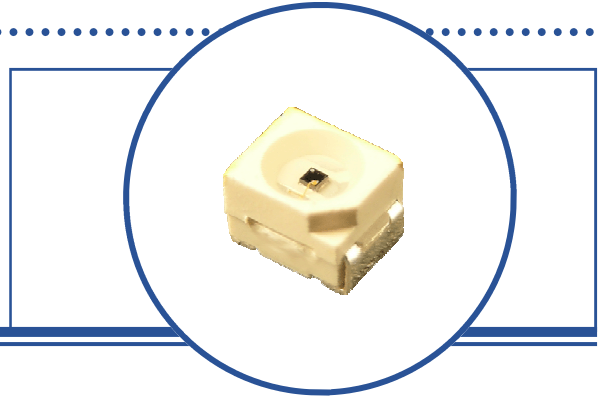

Description:

The **OP580DA** is an NPN silicon photodarlington mounted in a miniature SMD package. This device has a flat window lens, which enables a wide acceptance angle. It is packaged in a plastic leadless chip carrier which is compatible with most automated mounting equipment. **OP580DA** are 100% production tested using infrared light for close correlation with Optek GaAs and GaAlAs emitters. Photo darlington devices are normally used in application where light signals are low and more current gain is needed than is possible with phototransistors.

OP580DA is mechanically and spectrally matched to the OP280 series infrared LEDs.

Applications:

- Non-contact position sensing
- Machine automation
- Datum detection
- Optical encoders

Ordering Information			
Part Number	Sensor	Viewing Angle	Lead Length
OP580DA	Photo Darlington	100°	N/A

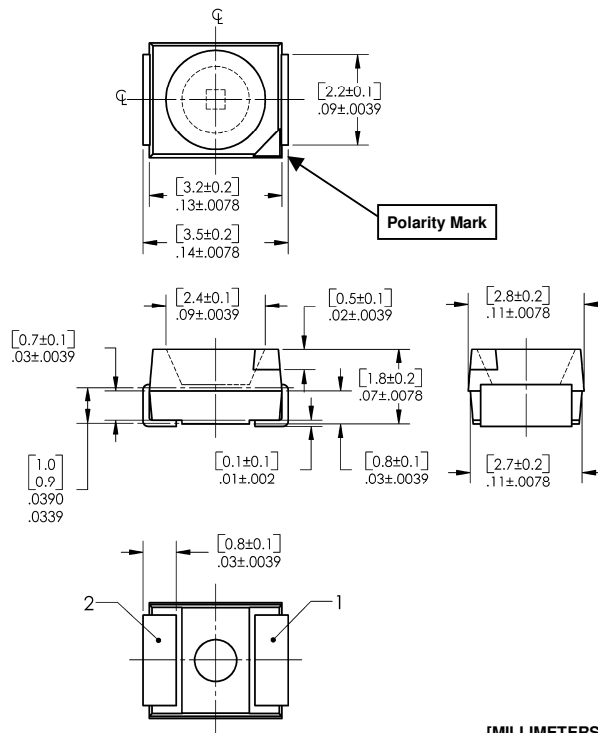

OP580DA

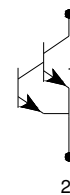

Pin #	Transistor
1	Collector
2	Emitter



RoHS

OPTEK reserves the right to make changes at any time in order to improve design and to supply the best product possible.

Absolute Maximum Ratings ($T_A=25^\circ\text{C}$ unless otherwise noted)

Storage Temperature Range	-40° C to +100° C
Operating Temperature Range	-25° C to +85° C
Lead Soldering Temperature	260° C ⁽¹⁾
Collector-Emitter Voltage	35 V
Emitter-Collector Voltage	5 V
Collector Current	32 mA
Power Dissipation	100 mW ⁽²⁾

Electrical Characteristics ($T_A = 25^\circ\text{C}$ unless otherwise noted)

SYMBOL	PARAMETER	MIN	TYP	MAX	UNITS	TEST CONDITIONS
$I_{C(ON)}$	On-State Collector Current	10.0	-	-	mA	$V_{CE} = 5.0\text{ V}, E_E = 0.15\text{ mW/cm}^{2(3)}$
$V_{CE(SAT)}$	Collector-Emitter Saturation Voltage	-	-	1.7	V	$I_C = 1\text{ mA}, E_E = 0.15\text{ mW/cm}^{2(3)}$
I_{CE0}	Collector-Emitter Dark Current	-	-	1.0	μA	$V_{CE} = 5.0\text{ V}, E_E = 0^{(4)}$
$V_{(BR)CEO}$	Collector-Emitter Breakdown Voltage	35	-	-	V	$I_C = 400\ \mu\text{A}$
$V_{(BR)ECO}$	Emitter-Collector Breakdown Voltage	5	-	-	V	$I_E = 100\ \mu\text{A}$
t_r, t_f	Rise Time , Fall Time	-	50	-	μs	$I_C = 1\text{ mA}, R_L = 1\text{ K}\Omega$

Notes:

- Solder time less than 5 seconds at temperature extreme.
- Derate linearly at 1.33 mW/°C above 25° C.
- $E_{E(APT)}$ is an unfiltered GaAs LED with a peak emission wavelength of 935 nm and a radiometric intensity level which varies less than 10% over the entire lens surface of the phototransistor being tested.
- To calculate typical collector dark current in μA , use the formula $I_{CE0} = 10^{(0.04 T_A - 3/4)}$ where T_A is the ambient temperature in °C.

Relative Response vs Wavelength

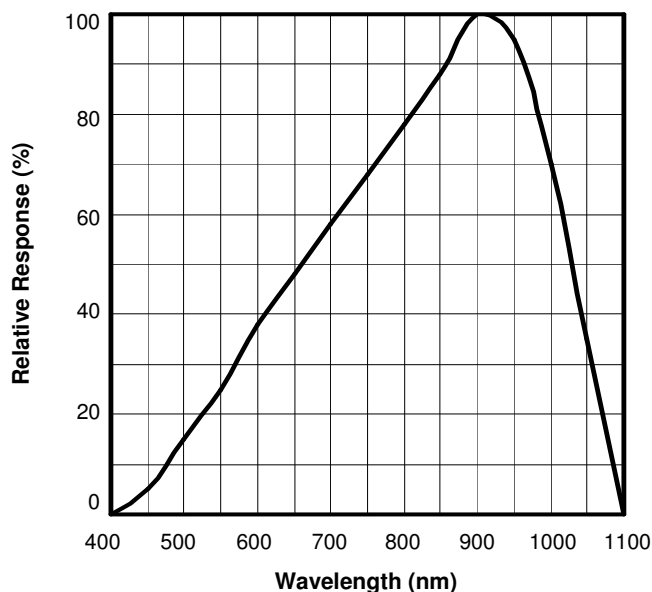

Relative Response vs Angular Position

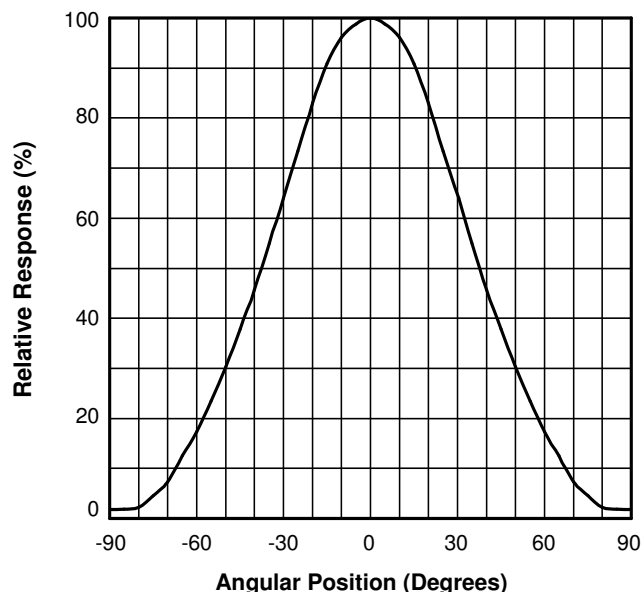

OPTEK reserves the right to make changes at any time in order to improve design and to supply the best product possible.

Relative Collector Current- I_C (mA)
vs. Irradiance- E_e (mW/cm²)

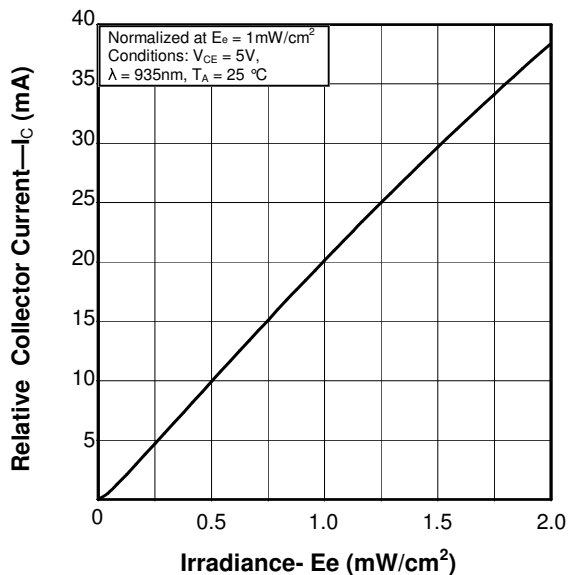

Relative On-State Collector Current
vs Temperature

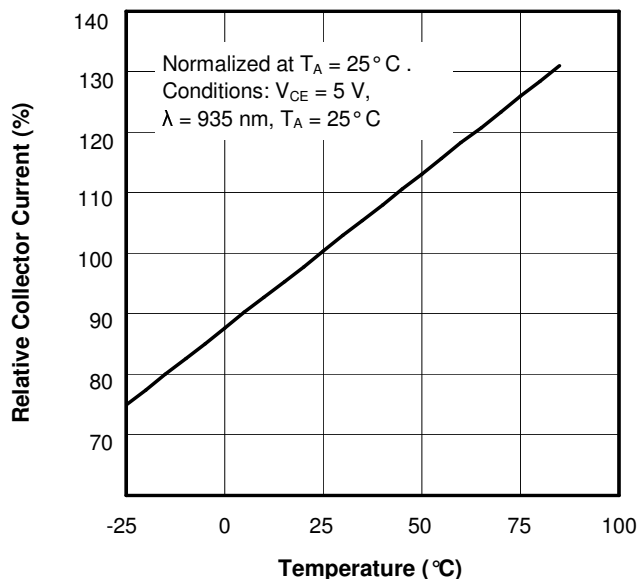

Collector-Emitter Dark Current
vs Temperature

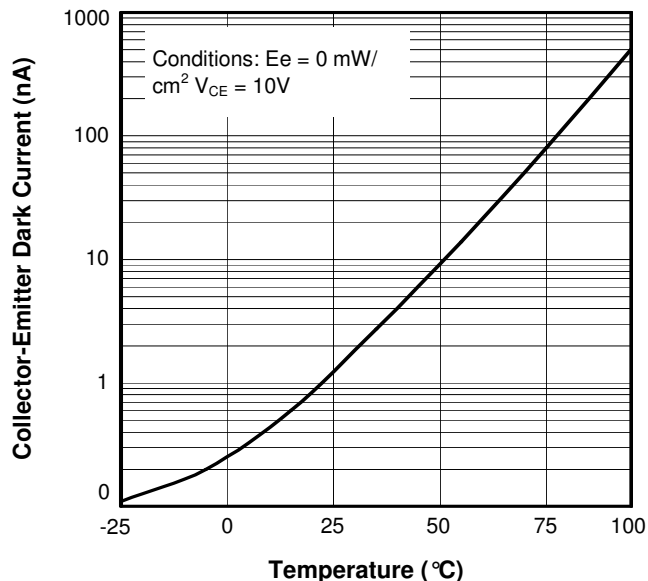

Relative On-State Collector Current
vs. Collector-Emitter Voltage

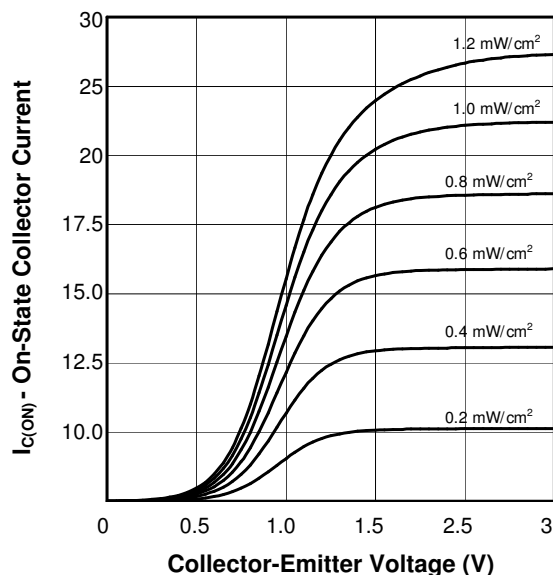

OPTEK reserves the right to make changes at any time in order to improve design and to supply the best product possible.