

NPN Silicon Phototransistors

Types OP550A, OP550B, OP550C, OP550D

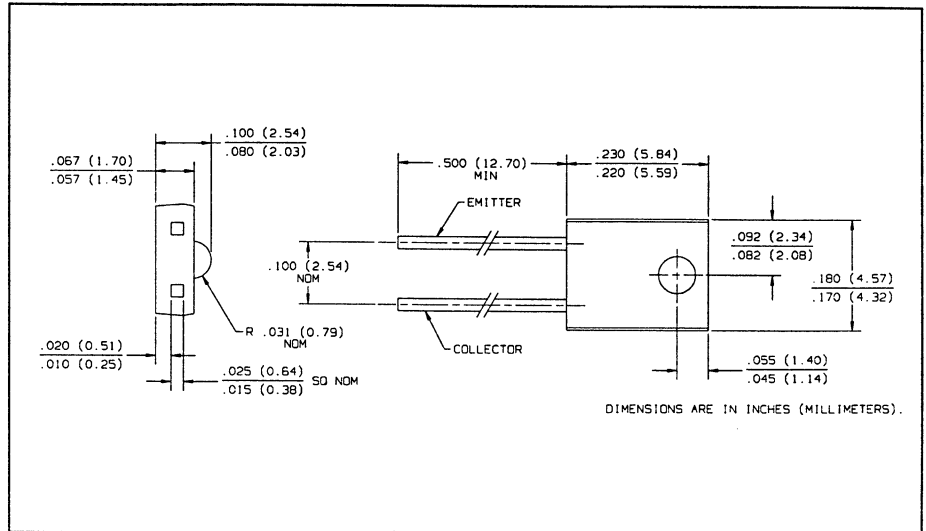
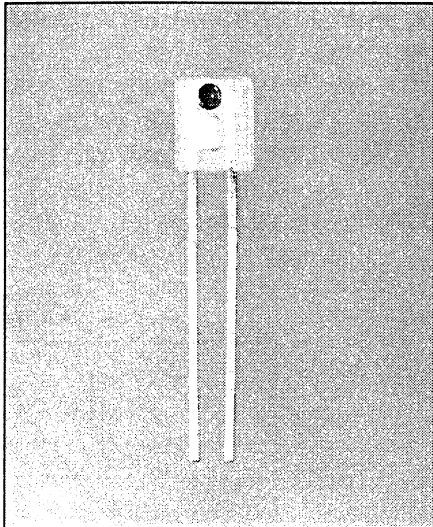

Features

- Wide receiving angle
- Variety of sensitivity ranges
- Side-looking package for space limited applications

Description

The OP550 series devices consist of NPN silicon phototransistors molded in clear epoxy packages. The wide receiving angle provides relatively even reception over a large area. The side-looking package is designed for easy PC board mounting of slotted optical switches or optical interrupt detectors. This series is mechanically and spectrally matched to the OP140 and OP240 series of infrared emitting diodes.

Absolute Maximum Ratings ($T_A = 25^\circ\text{C}$ unless otherwise noted)

Collector-Emitter Voltage	30 V
Emitter-Collector Voltage	5.0 V
Storage and Operating Temperature Range	-40°C to $+100^\circ\text{C}$
Lead Soldering Temperature [1/16 inch (1.6 mm) from case for 5 sec. with soldering iron]	$260^\circ\text{C}^{(1)}$
Power Dissipation	100 mW ⁽²⁾

Notes:

- (1) RMA flux is recommended. Duration can be extended to 10 sec. max. when flow soldering. Max. 20 grams force may be applied to leads when soldering.
- (2) Derate linearly $1.33\text{ mW}/^\circ\text{C}$ above 25°C .
- (3) Light source is an unfiltered GaAs LED with a peak emission wavelength of 935 nm and a radiometric intensity level which varies less than 10% over the entire lens surface of the phototransistor being tested.
- (4) To calculate typical collector dark current in μA , use the formula $I_{CED} = 10^{(0.040 T_A - 3.4)}$ where T_A is ambient temperature in $^\circ\text{C}$.

Typical Performance Curves

Typical Spectral Response

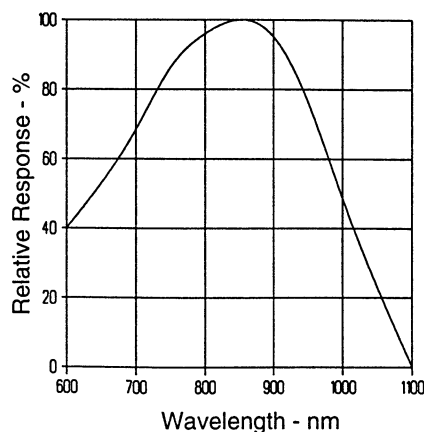

Coupling Characteristics of OP140 and OP550

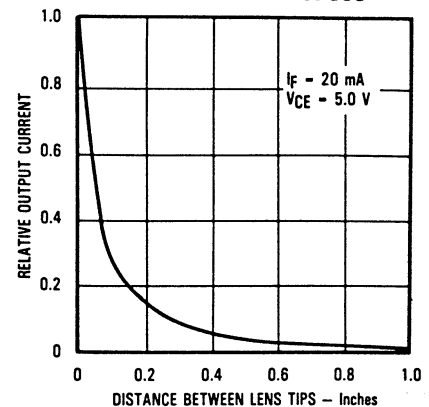

Types OP550A, OP550B, OP550C, OP550D

Electrical Characteristics ($T_A = 25^\circ\text{C}$ unless otherwise noted)

SYMBOL	PARAMETER	MIN	TYP	MAX	UNITS	TEST CONDITIONS
$I_{C(ON)}$	On-State Collector Current	OP550D 0.25		2.40	mA	$V_{CE} = 5.0\text{ V}$, $E_e = 1.0\text{ mW/cm}^2(3)$
		OP550C 0.25		4.70	mA	
		OP550B 1.30			mA	
		OP550A 2.55			mA	
$\Delta I_C/\Delta T$	Relative I_C Changes with Temperature		1.00		$\%/^\circ\text{C}$	$V_{CE} = 5.0\text{ V}$, $E_e = 1.00\text{ mW/cm}^2$, $\lambda = 935\text{ nm}$
I_{CEO}	Collector Dark Current		100		nA	$V_{CE} = 10.0\text{ V}$, $E_e = 0(4)$
$V_{(BR)CEO}$	Collector-Emitter Breakdown Voltage	30			V	$I_C = 100\ \mu\text{A}$
$V_{(BR)ECO}$	Emitter-Collector Breakdown Voltage	5.0			V	$I_E = 100\ \mu\text{A}$
$V_{CE(SAT)}$	Collector-Emitter Saturation Voltage		0.40		V	$I_C = 100\ \mu\text{A}$, $E_e = 1.0\text{ mW/cm}^2(3)$

PHOTOSENSORS

Typical Performance Curves

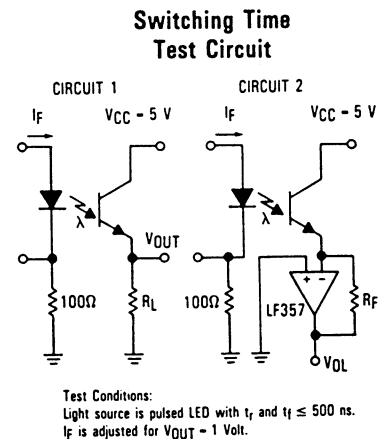
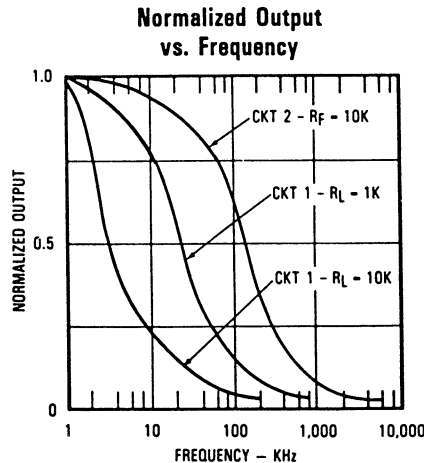
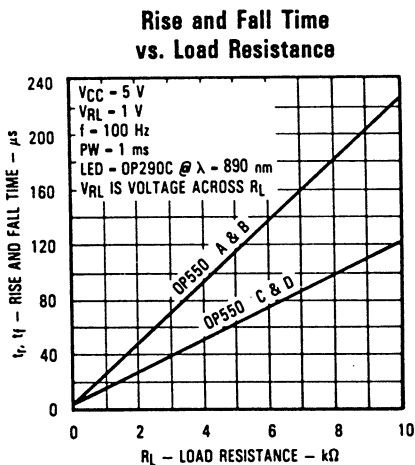
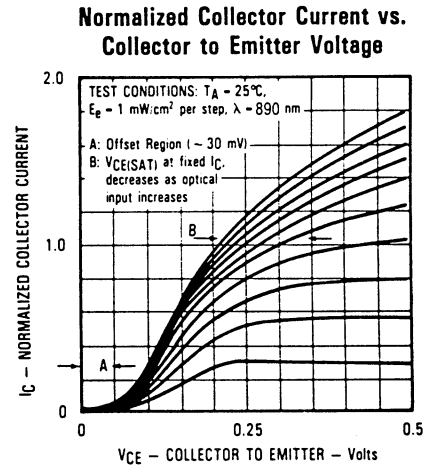
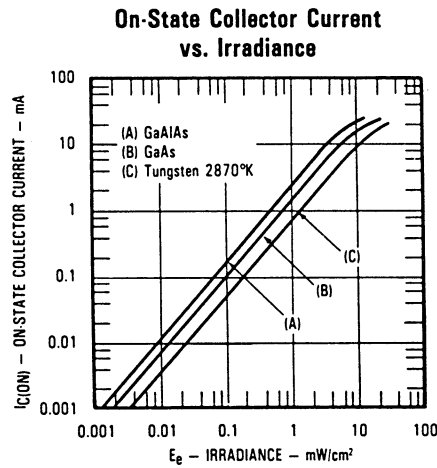
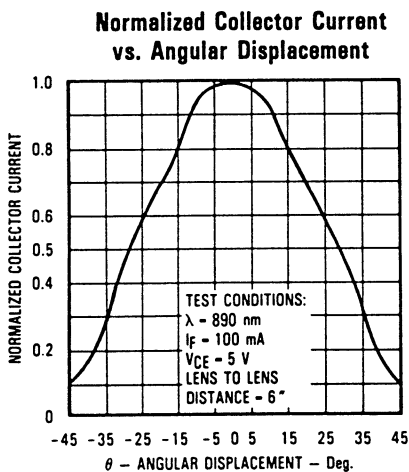

Optek reserves the right to make changes at any time in order to improve design and to supply the best product possible.
 Optek Technology, Inc. 1215 W. Crosby Road Carrollton, Texas 75006 (972)323-2200 Fax (972)323-2396